

**PROPOSED GANTRY DESIGN  
FOR SPANS 80'-0" TO 100'-0"**

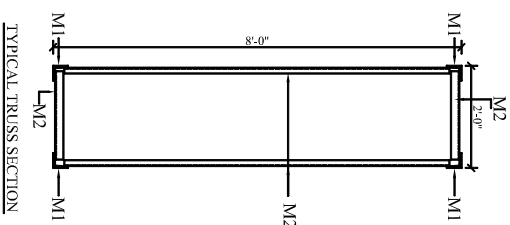
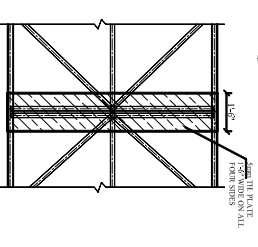
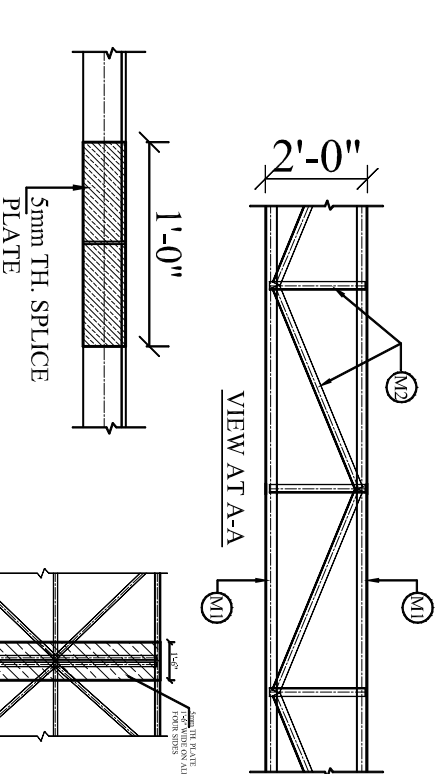
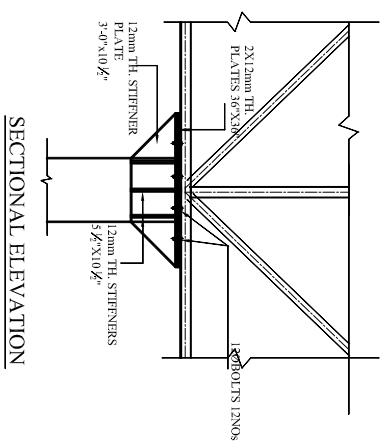
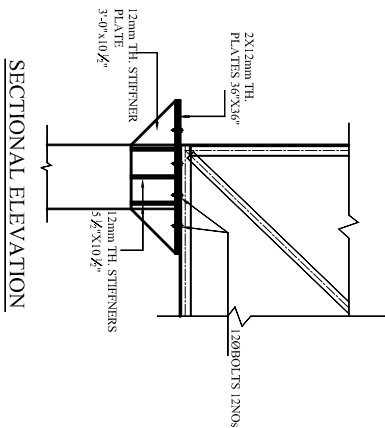
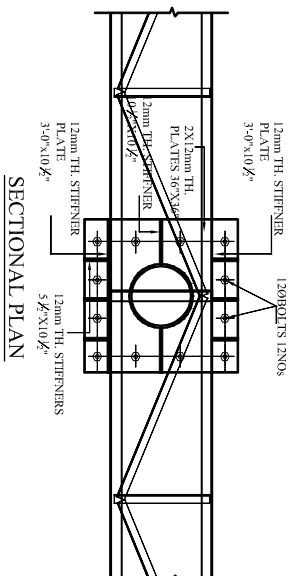
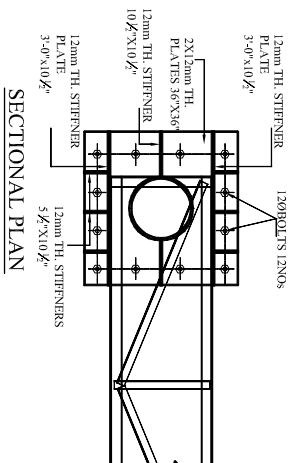

TYPICAL DETAIL OF SPLICE OF ANGLE

REFERENCE/REVISIONS

NO.	REVISION/ISSUE	DATE

TITLE :- DETAIL OF JOINTS AND CONNECTIONS  
SPAN: 80'-0" TO 100'-0"

DRG. NO. : SLDG1X80X100003	SCALE: NTS
DATE: 31-08-15	DEALT BY: :
SNO.:	
CONSULTANT	OWNER

PROJECT CONSULTANT

