

इंटरनेट

मानक

Disclosure to Promote the Right To Information

Whereas the Parliament of India has set out to provide a practical regime of right to information for citizens to secure access to information under the control of public authorities, in order to promote transparency and accountability in the working of every public authority, and whereas the attached publication of the Bureau of Indian Standards is of particular interest to the public, particularly disadvantaged communities and those engaged in the pursuit of education and knowledge, the attached public safety standard is made available to promote the timely dissemination of this information in an accurate manner to the public.

“जानने का अधिकार, जीने का अधिकार”

Mazdoor Kisan Shakti Sangathan

“The Right to Information, The Right to Live”

“पुराने को छोड़ नये के तरफ”

Jawaharlal Nehru

“Step Out From the Old to the New”

SP 20 (1991): Handbook on Masonry Design and Construction
[CED 13: Building Construction Practices including
Painting, Varnishing and Allied Finishing]



“ज्ञान से एक नये भारत का निर्माण”

Satyanarayan Gangaram Pitroda

“Invent a New India Using Knowledge”



“ज्ञान एक ऐसा खजाना है जो कभी चुराया नहीं जा सकता है”

Bhartrhari—Nitiśatakam

“Knowledge is such a treasure which cannot be stolen”

BLANK PAGE



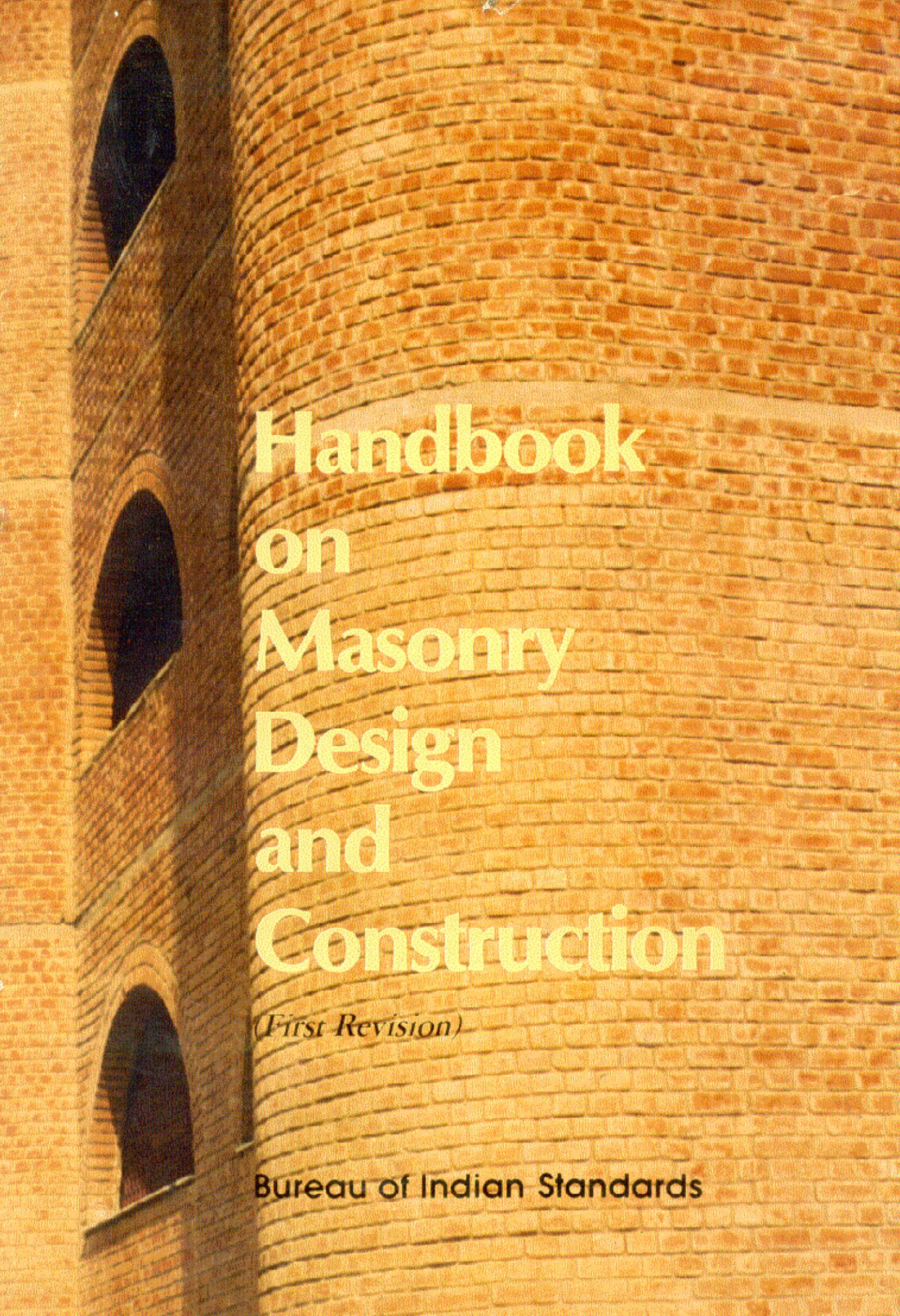

**Handbook
on
Masonry
Design
and
Construction**

(First Revision)

Bureau of Indian Standards

**HANDBOOK
ON
MASONRY DESIGN
AND
CONSTRUCTION**

(First Revision)

**BUREAU OF INDIAN STANDARDS
MANAK BHAVAN, 9 BAHADUR SHAH ZAFAR MARG
NEW DELHI 110002**

SP 20(S&T) : 1991

FIRST PUBLISHED NOVEMBER 1981

FIRST REVISION MARCH 1991

© BUREAU OF INDIAN STANDARDS 1991

UDC 693

ISBN 81-7061-029-X

PRICE Rs 200.00

PRINTED IN INDIA
AT KAPOOR ART PRESS, A38/3 MAYAPURI, NEW DELHI
AND PUBLISHED BY
BUREAU OF INDIAN STANDARDS, NEW DELHI 110002

**COMPOSITION OF THE SPECIAL COMMITTEE FOR IMPLEMENTATION
OF SCIENCE AND TECHNOLOGY PROJECTS (SCIP)**

Chairman

DR H. C. VISVESVARAYA
Vice-Chancellor
University of Roorkee
Roorkee

Members

Dr M. Ramaiah

Dr R. K. Bhandari

Shri V. Rao Aiyagari

Shri Harish Chandra

Shri M. L. Mehta

Shri S. K. Datta (*Alternate*)

Shri J. D. Chaturvedi

Shri J. Venkataraman
(*Member Secretary*)

Representing

Structural Engineering Research Centre
(CSIR), Madras

Central Building Research Institute,
Roorkee

Department of Science & Technology,
New Delhi

Central Public Works Department,
New Delhi

Metallurgical and Engineering Consultants
(India) Ltd, Ranchi

Planning Commission, New Delhi

Bureau of Indian Standards, New Delhi

As in the Original Standard, this Page is Intentionally Left Blank

FOREWORD

Users of various civil engineering codes have been feeling the need for explanatory handbooks and other compilations based on Indian Standards. The need has been further emphasized in view of the first publication of the National Building Code of India in 1970 (which has since been revised in 1983) and its implementation. The Expert Group set up in 1972 by the Department of Science and Technology, Government of India carried out in-depth studies in various areas of civil engineering and construction practices. During the preparation of the Fifth Five-Year Plan in 1975, the Group was assigned the task of producing a Science and Technology Plan for research, development and extension work in the sector of housing and construction technology. One of the items of this plan was the formulation of design handbooks, explanatory handbooks and design aids based on the National Building Code and various Indian Standards and other activities in the promotion of the National Building Code. The Expert Group gave high priority to this item and on the recommendation of the Department of Science and Technology, the Planning Commission approved the following two projects which were assigned to the Bureau of Indian Standards (erstwhile Indian Standards Institution):

- a) Development programme on code implementation for building and civil engineering construction, and
- b) Typification for industrial buildings.

A special committee for Implementation of Science and Technology Projects (SCIP) consisting of experts connected with different aspects was set up in 1974 to advise the BIS Directorate General in identifying and for guiding the development of the work. Under the first project, the Committee has identified several subjects for preparing explanatory handbooks/compilations covering appropriate Indian Standards/codes specifications which include the following:

**Handbooks Published:*

1. Design Aids for Reinforced Concrete to IS 456 : 1978 (SP 16 : 1980)
2. Explanatory Handbook on Codes of Earthquake Engineering (IS 1893 : 1975 and IS 4326 : 1976) (SP 22 : 1982)
3. Handbook on Concrete Mixes (SP 23 : 1982)
4. Explanatory Handbook on Indian Standard Code of Practice for Plain and Reinforced Concrete (IS 456 : 1978) (SP 24 : 1983)
5. Handbook on Causes and Prevention of Cracks in Buildings (SP 25 : 1984)
6. Summaries of Indian Standards for Building Materials (SP 21 : 1983)
7. Handbook on Concrete Reinforcement and Detailing (SP 34 : 1987)
8. Handbook on Functional Requirements of Industrial Buildings (Lighting and Ventilation) (SP 32 : 1986)
9. Handbook on Timber Engineering (SP 33 : 1986)
10. Handbook on Water Supply and Drainage with Special Emphasis on Plumbing (SP 35 : 1987)
11. Handbook on Functional Requirements of Buildings (other than Industrial Buildings) (SP 41 : 1987)

Subjects Under Programme:

- Foundation of Buildings
- Construction Safety Practices
- Building Construction Practices

- Formwork
- Fire Safety
- Tall Buildings
- Loading Code

The Explanatory Handbook on Masonry Code SP 20 (S&T) was first published in 1981 to provide commentary on various clauses of Part VI, Section 4 of National Building Code of India 1970 (which was based on IS 1905 : 1969 version) with the object of promoting and facilitating the use of the masonry code. The handbook has been found to be very helpful to professional engineers. This handbook while providing commentary on various clauses highlighted certain improvements/modifications that were needed in the basic code (IS 1905 : 1969). Subsequent to publication of the handbook, the code (IS 1905) was revised in 1980 (IS 1905 : 1980) taking into consideration the recommendations contained in the handbook (*see also* Introduction).

The code was further revised in 1987 as a result of the experience gained with the use of 1980 version of the code and also other developments in other parts of the world in the design and construction refinements of masonry structures. The revision of the handbook was also taken up simultaneously along with the revision of the code to make it up-to-date. At the same time it was felt that it would be helpful and handy to professionals if information relating to construction practices based on various Indian Standards on masonry was also included along with the commentary. Therefore masonry construction practices have now been included in the revised handbook and the title of the handbook has been changed accordingly.

The revised handbook is in two parts. Part 1 gives commentary on 'IS 1905 : 1987 Code of practice for structural use of unreinforced masonry (*second revision*)' along with design examples (IS 1905 : 1987 has also been included in the National Building Code Part VI, Section 4 Masonry through amendment No. 2) and Part 2 gives all construction aspects relating to masonry construction based on relevant Indian Standards and other literature available on the subject.

The following points are to be kept in view while using the handbook:

- a) Wherever the expression 'The Code' has been used in the handbook, it refers to IS 1905 : 1987.
- b) Part 1 of the handbook is to be read along with IS 1905 : 1987.
- c) The clause numbers in Part 1 of handbook refer to the corresponding clause numbers in IS 1905 : 1987. The clauses are explained in the same sequence as they occur in IS 1905 : 1987. When there are no comments to a particular clause, the same has been omitted.
- d) For convenience figures and tables appearing in Part 1 of the handbook are identified with Prefix 'E' to distinguish them from those used in the code. For example, Figure E-3 refers to the figure in the handbook whereas Figure 3 refers to that given in the Code. Where a clause is pre-fixed by letter 'E', it refers to comments on that clause in the handbook.
- e) Notations as per IS 1905 : 1987 are maintained with additional notations wherever necessary.
- f) The handbook does not form part of any Indian Standard on the subject and does not have the status of an Indian Standard. Wherever there is any dispute about the interpretation or opinion expressed in this handbook, the provisions of the Code(s) only shall apply; the provisions of this handbook should be considered as only supplementary and informative.
- g) References cited have been listed at the end of each part of the handbook.

The handbook, it is hoped would be useful to practising engineers and field engineers in the design and construction of masonry work. It would also be helpful to students of civil engineering to acquaint themselves with the various provisions of the basic Code on masonry and construction practices.

The handbook is based on first draft revision prepared by Shri M. S. Bhatia, retired Engineer-in-Chief, Central Public Works Department (Government of

India). The draft handbook was circulated for review to Central Public Works Department, New Delhi; Engineer-in-Chief's Branch, Army Headquarters, New Delhi; Sr. Civil Engineer (Design), Northern Railway, New Delhi; National Buildings Organization, New Delhi; Central Building Research Institute, Roorkee; Central Road Research Institute, New Delhi; Shri M.G. Virmani, New Delhi; Public Works Deptt., Govt of Tamilnadu, Madras; Maulana Azad College of Technology, Bhopal; Public Works Deptt. Maharashtra, Bombay; Tirath Ram Ahuja Pvt Ltd, New Delhi; National Buildings Construction Corporation Ltd, New Delhi; National Council for Cement and Building Materials, New Delhi; Structural Engineering Research Centre, Madras; M/s C. R. Narayana Rao, Madras; Tata Consulting Engineers, Bombay; Indian Institute of Technology, Kanpur; Civil Engineering Department, University of Roorkee, Roorkee; Punjab Public Works Department, Patiala; Structural Designers and Consultants Pvt Ltd, Bombay; Indian Institute of Technology, Kharagpur; Indian Institute of Architects, New Delhi; School of Planning & Architecture, New Delhi; Shri D. N. Chopra, New Delhi; Shri T. S. Khareghate, Bombay; Department of Earthquake Engineering, University of Roorkee, Roorkee; Housing and Urban Development Corporation Ltd, New Delhi; Tamilnadu Housing Board, Madras; Delhi Development Authority, New Delhi; Andhra Pradesh Housing Board, Hyderabad; Rajasthan Housing Board, Jaipur; Shri Thomas Mathew, Cochin; Central Vigilance Commission, New Delhi; Chief Municipal Architect, Calcutta and the views expressed were taken into consideration while finalizing the handbook.

As in the Original Standard, this Page is Intentionally Left Blank

INTRODUCTION

Until 1950's there were no engineering methods of designing masonry for buildings and thickness of walls was being based on 'Rule-of-Thumb' Tables given in Building Codes and Regulations. As a result walls used to be very thick and masonry structures were found to be very uneconomical beyond 3 or 4 storeys. Buildings exceeding 3 or 4 storeys had thus to be constructed with steel or RCC frames. Since 1950's intensive theoretical and experimental research has been conducted on various aspects of masonry in advanced countries. As a result different factors which effect strength, stability and performance of masonry structures have been identified and methods of design based on engineering principles evolved. Most of the countries have therefore switched over to use of so-called "calculated or engineering masonry" of structures. Simultaneously methods of manufacture of bricks and construction techniques have been considerably improved upon.

The basic advantage of masonry construction lies in the fact that in load bearing structures, it performs a variety of functions, namely, supporting loads, subdividing space, providing thermal and acoustic insulation, affording fire and weather protection, etc, which in a framed building, have to be provided for separately. No doubt, use of masonry in load bearing structures has certain limitations, but it is suited for a building in which floor area is subdivided into a large number of rooms of small or medium size and in which the floor plan is repeated in each storey throughout the height of the building. These conditions are met with in residential buildings, hostels, nursing homes, hospitals, schools and certain types of administrative buildings. Extensive research, including large scale testing, has been carried out in regard to the behaviour of masonry which has enabled engineers and architects to design tall masonry structures on sound engineering principles with greater exactitude, economy and confidence. There are many recent examples in other countries of well designed 12 to 20 storeyed load bearing masonry buildings which have only 25 to 40 cm thick walls. This is in contrast to the 16 storey 'Monadnock Building' in Chicago designed by John Rort in 1891 with 180 cm thick brick walls at the base.

In India there has not been much progress in the construction of tall load bearing masonry structures, mainly because quality of bricks generally manufactured in the country is poor, their normal strength being of the order of only 7 to 10 N/mm². In many Western countries, bricks of even medium quality have crushing strength of 30 to 50 N/mm². However, recently mechanized brick plants have been set up at a few places in the country which are producing bricks of strength 17.5 to 25 N/mm². Thus, it should now be possible in some parts of the country to go in for 5 to 6 storeyed load bearing structures at costs less than those of RCC framed structures. With this development, structural design of load bearing masonry buildings has assumed additional importance in India as well. In fact under the Experimental Projects Scheme of the National Buildings Organization, 50 residential units in 5 storeyed blocks, having one brick, that is 25.4 cm thick load bearing brick masonry walls in all the storeys were constructed at Manicktola, Calcutta in 1975 and construction of 20 residential units in 5 storeyed blocks, having one brick, that is, 22.9 cm thick walls, have been constructed in New Delhi.

Buildings are presently designed in western countries mostly by allowable stress method of design. Walls are designed as vertical cantilevers with no moment transfer at wall to floor connection. Lateral loads are distributed to cross walls according to their stiffness and locations by the diaphragm action of floor and roof slabs acting as horizontal beams. It has been found that eccentricity of load from a slab at the top of a masonry element gets reduced at the bottom support of the wall. In some countries limit state design method is now coming into vogue because of better reliability and economy obtained through the adoption of this method. For large and important projects strength of masonry is based on 'for-the-job' prism tests instead of placing reliance on standard tables. In seismic zones masonry consisting of hollow blocks is reinforced vertically to take tension. In some countries structural advantage is taken of the fact that use of through-wall units results in stronger masonry. In tall single storey long-span buildings such as

churches, sports stadia, large halls, etc, use of Diaphragm type masonry walls is proving to be an economical innovation.

Before concluding, a brief mention may be made of some special features and trends of load bearing masonry in other countries for information of designers. These are as follows:

- a) Manufacture and use of high strength burnt clay units (70 to 100 N/mm²) with perforations for passing vertical reinforcement where necessary.
- b) Use of high-bond organic modified mortars (polymers) to obtain masonry with very high compressive as well as bond strength.
- c) Basing design calculations for structural masonry on prism/cube strength of masonry with units and mortar actually proposed to be used in the job.
- d) Use of 'Through-Wall-Units' in order to achieve higher efficiency of masonry (ratio of masonry strength to unit strength). With the use of these units, vertical wall-joints in masonry are eliminated.
- e) Use of floors/roofs of high stiffness in order to reduce eccentricity of loading on walls.
- f) Use of prefabricated brick panels in masonry.
- g) Use of facing bricks in conjunction with normal bricks for external walls, for architectural effects.
- h) Prestressing of masonry elements.

There is need and considerable scope in this country of intensifying experimental, research and study in the field of load bearing masonry in order to make better and more economical use of this wonderful and versatile building material—the brick.

In India we have been trying to keep pace to some extent with the developments taking place in other countries in regard to masonry and in 1961, ISI (now BIS) published its first Code on Masonry which made provisions for design of masonry based on working stress method. This code was revised in 1969. Certain provisions were upgraded based on improvements brought about in Codes of some other countries. Unfortunately there has not been much of research on the subject in our country. In 1976, BIS undertook the task of publishing a handbook on masonry and during the preparatory work certain deficiencies in the Code came to light. The Code was therefore further revised in 1980 and a comprehensive handbook on masonry with clause-wise commentary and analysis, illustrative examples and design tables was published in 1981. In view of the growing interests of the users of Code and handbook and practical importance of this subject to designers and builders, the Code as well as the handbook and practical importance of this subject to designers and builders, the Code as well as the handbook have been further revised and updated. Now Building Regulations incorporate the concept of engineered masonry contained in the Code, where as earlier in our country one brickwall could only be a single storey building. Presently one brick walls are built-up to 4-5 storeys in many parts of the country.

The revised Code along with the handbook it is hoped would be of considerable help to engineers in the design and construction of masonry buildings especially tall buildings.

CONTENTS

	<i>Page</i>
FOREWORD	v
INTRODUCTION	ix
PART 1	
1. SCOPE	3
2. TERMINOLOGY	3
3. MATERIALS	4
3.1 Masonry Units	4
3.2 Mortar	6
4. DESIGN CONSIDERATIONS	8
4.1 General	8
4.2 Lateral Supports and Stability	9
4.2.2 Stability	9
4.3 Effective Height	10
4.3.1 Wall	10
4.3.2 Column	10
4.3.3 Openings in Walls	10
4.4 Effective Length	11
4.5 Effective Thickness	11
4.6 Slenderness Ratio	11
4.7 Eccentricity	13
5. STRUCTURAL DESIGN	13
5.1 General	13
5.3 Load Dispersion	15
5.3.1 General	15
5.3.2 Arching Action	17
5.3.3 Lintels	19
5.4 Permissible Stresses	20
5.4.1 Permissible Compressive Stress	20
5.4.1.1 Stress reduction factor	20
5.4.1.2 Area reduction factor	20
5.4.1.3 Shape reduction factor	22
5.4.1.4 Increase in permissible compressive stresses allowed for eccentric vertical and/or lateral loads under certain conditions	22
5.4.2 Permissible Tensile Stress	24
5.4.3 Permissible Shear Stress	25
5.5 Design Thickness/Cross Section	25
5.5.1 Walls and Columns Subjected to Vertical Loads	25
5.5.1.1 Solid walls	25
5.5.2 Walls and Columns Mainly Subjected to Lateral Loads	25
5.5.2.1 Free standing walls	25
5.5.2.2 Retaining walls	25
5.5.3 Walls and Columns Subjected to Vertical as well as Lateral Loads	25
5.5.4 Walls Subjected to In-Plan Bending and Vertical Loads (Shear Walls)	26
5.5.5 Non-Load Bearing Walls	26
6. GENERAL REQUIREMENTS	28
6.1 Methods of Construction	28
6.2 Minimum Thickness of Walls from Consideration other than Structural	28

6.3 Workmanship	29
6.4 Joints to Control Deformation and Cracking	30
6.6 Corbelling	30
ANNEXES	31
ANNEX H-1 WORKED EXAMPLES ON DESIGN OF STRUCTURAL MASONRY	31
ANNEX H-2 DESIGN OF BRICK MASONRY FOR RESIDENTIAL BUILDINGS UP TO 3 STOREYS	53
ANNEX H-3 DESIGN OF BRICK MASONRY FOR OFFICE BUILDINGS UP TO 3 STOREYS	73
ANNEX H-4 NOTATIONS, SYMBOLS AND ABBREVIATIONS	104
PART 2	
SECTION 1 GENERAL	107
1.1 Introduction	107
1.2 Materials	107
1.3 Masonry Units	108
1.4 Mortar	111
1.5 Scaffolding	122
1.6 Curing	124
SECTION 2 BRICK MASONRY	124
2.1 General	124
2.2 Bonds	124
2.3 Laying of Brick Masonry	126
2.4 Fixing Door and Window Frames	127
2.5 Honey-Combed Brick Masonry	127
2.6 Brick Masonry Curved on Plan	127
2.7 Extension of Old Brick Masonry	127
2.8 Corbelling	128
2.9 Efflorescence	128
SECTION 3 STONE MASONRY	129
3.1 General	129
3.2 Random Rubble Masonry	129
3.3 Coursed Rubble Masonry	131
3.4 Ashlar Masonry	132
3.5 Laterite Stone Masonry	133
3.6 Stone Veneering	133
3.7 Miscellaneous Items	134
SECTION 4 CONCRETE BLOCK MASONRY	138
4.1 General	138
4.2 Handling and Storage of Blocks	139
4.3 Laying of Blocks	139
4.4 Rendering and Other Finishes	140
4.5 Treatment at Openings and Fixing of Door and Window Frames	140
4.6 Provision of Lintels	140
4.7 Intersecting Walls	140
4.8 Provision of Floor/Roof	140
SECTION 5 MASONRY ELEMENTS	140
5.1 General	140
5.2 Cavity Wall	140
5.3 Retaining Wall	141
5.4 Masonry Arches	142
5.5 Masonry Domes	143

SECTION 6 SOME MISCELLANEOUS MATTERS RELATING TO MASONRY	143
6.1 General	143
6.2 Chases, Recesses and Holes	143
6.3 Brick Nogging and Dhajji Walling	144
6.4 Window Sills	145
6.5 Copings on Compound Walls and Parapets	145
6.6 Use of Fire Bricks	145
6.7 Flues and Chimneys in Residential Buildings	145
6.8 Protection of Masonry During Construction	146
6.9 Use of Reinforcement in Masonry	146
6.10 Prevention of Cracks in Masonry	147
6.11 Walling with Materials Other than Masonry	147
LIST OF REFERENCES AND BIBLIOGRAPHY	149

PART 1
COMMENTARY
ON
IS 1905:1987 CODE OF PRACTICE FOR STRUCTURAL
USE OF UNREINFORCED MASONRY
(Third Revision)

As in the Original Standard, this Page is Intentionally Left Blank

1 SCOPE

1.1 BIS has not yet formulated any Code of practice for design and construction of reinforced masonry since quality of bricks generally available in the country at present is not suitable for use in reinforced masonry. Bricks for this purpose should necessarily be of high strength and should also be dense, so that moisture absorption is less. If bricks have high moisture absorption, reinforcement gets corroded in course of time, thereby lowering its life expectancy.

1.2 Mud mortar for masonry as bonding material is normally not used in the present day construction because of its poor bonding quality. Mud mortar does attain some strength on drying, but it readily absorbs moisture on coming in contact with moisture or rain and loses its strength when wet. For temporary and low cost single storeyed houses, however, its use is sometimes made particularly in rural areas, when economy in cost is the main consideration. (Some information on use of mud mortar construction is given in 1.4.3.4 and 1.4.4.1 of Part 2.)

2 TERMINOLOGY

Some of the terms defined in this clause are illustrated in Fig. E-1 to E-9.

2.3.1 Need for making a distinction between column and wall arises because a column can take lesser unit load than a wall. This behaviour of masonry is based on experimental research and, in this context, it will be relevant to quote from the Proceedings of the Conference on Planning and Design of Tall Buildings¹ as follows:

“Walls and Columns—Plain Masonry—Mode of failure. The characteristic failure of wall

under compressive loading takes the form of vertical tensile cracks at mid-height and in line with the vertical mortar joints. The cracks can develop at such frequency as to become progressively slender columns side by side. The lower elasticity of mortar causes vertical compressive load to impart lateral strain movements to the mortar, which produces tensile stresses in the brick by inter-face bond whilst maintaining the bed-joint mortar in compression. The mortar is then in condition of triaxial compressive stress and the brick carries vertical compression in combination with biaxial lateral tension. Greater the height to length ratio of the wall, higher the value of horizontal tensile stresses at the vertical joints and, therefore, weaker the wall against vertical splitting under load.”

Since a column has greater height to length ratio in comparison to a wall, it has a lower permissible stress under a vertical load.

A masonry column has been defined as a vertical member the width of which does not exceed 4 times the thickness. This provision is based on British Standard CP III : Part 2 : 1970². However, in the National Building Code of Canada³ and also Recommended Practice for Engineered Bricks Masonry⁴, 1969, a column has been defined as a member whose width does not exceed 3 times the thickness.

2.9 Hollow Units

Shellback¹ found that in perforated bricks, type and distribution of voids influence the strength of bricks but for perforation areas up to 35 percent of the cross-section, the bricks have been found to behave as if solid. That explains the background

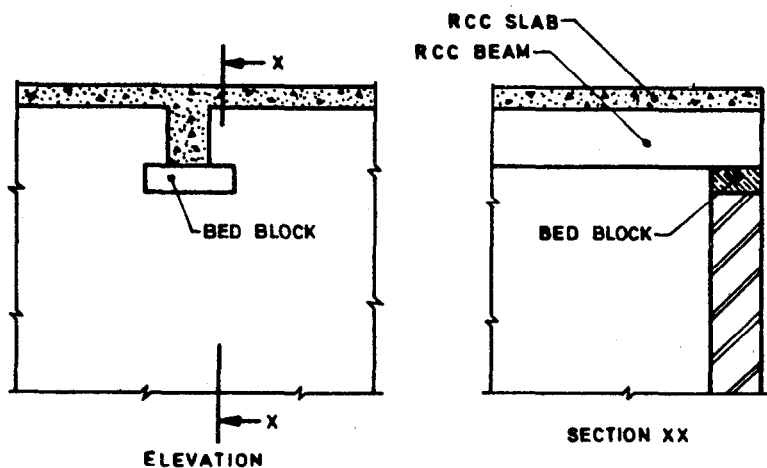

FIG. E-1 BED BLOCK

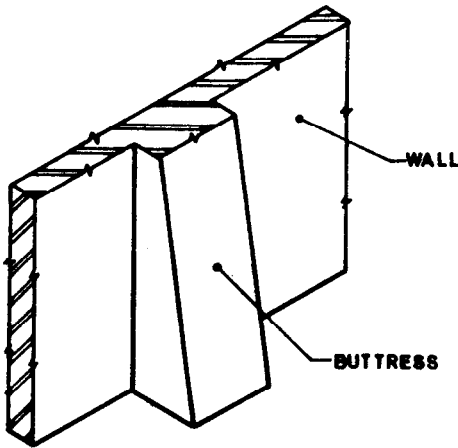
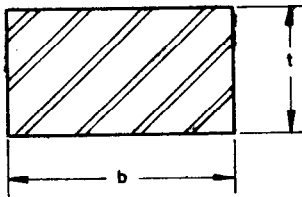
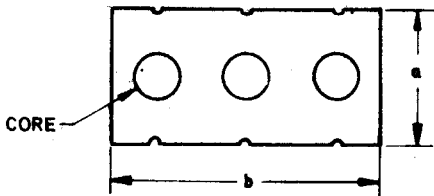

FIG. E-2 BUTTRESS



$b \leq t$

FIG. E-3 COLUMN



Gross Area = ab

Net Area = $ab - 3x$ when x is the area of one core

NOTE—Loss of area due to grooves is ignored.

FIG. E-4 CROSS-SECTIONAL AREA OF MASONRY UNIT

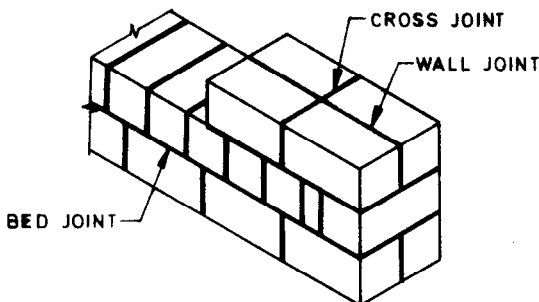

FIG. E-5 JOINTS IN MASONRY

for the definition of 'hollow units'.

3 MATERIALS

3.1 Masonry Units

i) Choice of masonry units is generally made from the consideration of: (a) local availability, (b) compressive strength, (c) durability, (d) cost, and (e) ease of construction. Brick has the advantage over stone that it lends itself to easy construction and requires less labour for laying. Stone masonry, because of practical limitations of dressing to shape and size, usually has to be thicker and results in unnecessary extra cost. Thus, the first choice for a building at any place, would be brick, if it is available at reasonable cost with requisite strength and good quality. In hills as well as in certain plains where soil suitable for making bricks is not available or cost of fuel for burning bricks is very high and stone is locally available, the choice would be stone. If type and quality of stone available is such that it cannot be easily dressed to shape and size, or if the cost of dressing is too high, use of concrete blocks may prove to be more economical, particularly when construction is to be more than two storeys, since thickness of walls can be kept within economical limits by using concrete blocks. In areas where bricks and stone of suitable quality are not available and concrete blocks cannot be manufactured at reasonable cost, and lime and sand of good quality are available, masonry units could be of sand-lime bricks. However, for manufacture of sand-lime bricks, special equipment is required, and thus use of sand-lime bricks is not common in India as yet.

ii) Strength of bricks in India varies from region to region depending on the nature of available soil and technique adopted for moulding and burning. Some research has been done for manufacture of bricks of improved quality from soils such as black cotton and moorum, which ordinarily give bricks of very low strength. The following statement based on information collected by BIS some time back, will give a general idea of the average strength of bricks in N/mm^2 available in various parts of India, employing commonly known methods for moulding and burning of bricks:

Delhi and Punjab	7 to 10
Uttar Pradesh	10 to 20
Madhya Pradesh	3.5 to 5
Maharashtra	5
Gujarat	3 to 10
Rajasthan	3
West Bengal	10 to 20
Andhra Pradesh	3
Assam	3.5

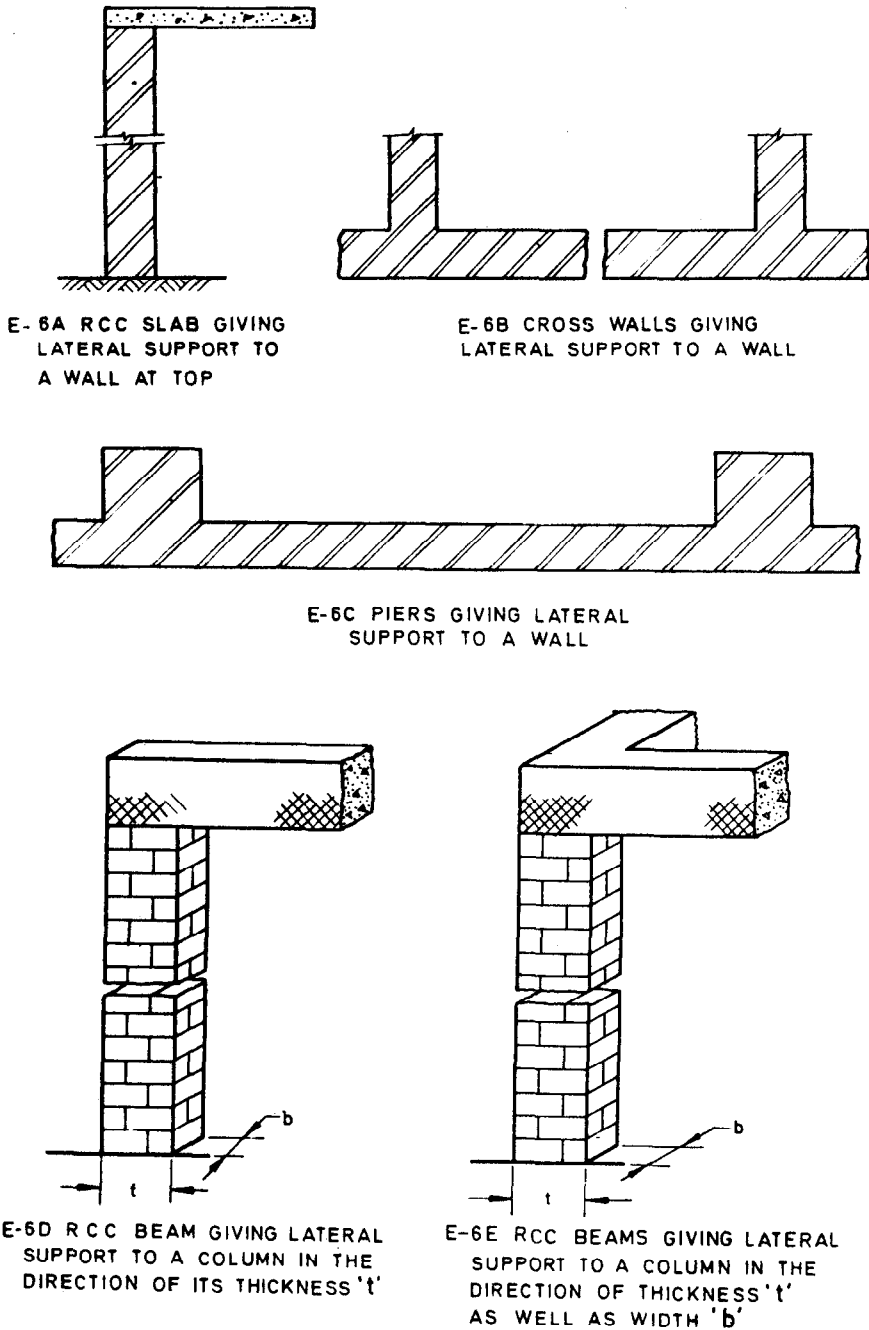

FIG. E-6 LATERAL SUPPORTS

In certain cities like Calcutta and Madras, machine-made bricks are now being produced, which give compressive strengths varying between 17.5 and 25 N/mm².

iii) The following relation generally holds good between strength of bricks and maximum number of storeys in case of simple residential buildings having one brick thick walls and rooms of medium size:

N/mm ²	Storeys
3 to 3.5	1 to 2
7	2 to 3
10	3 to 4
15	4 to 5

It is, however, possible to go higher than these levels by optimization of architectural and structural designs, for example,

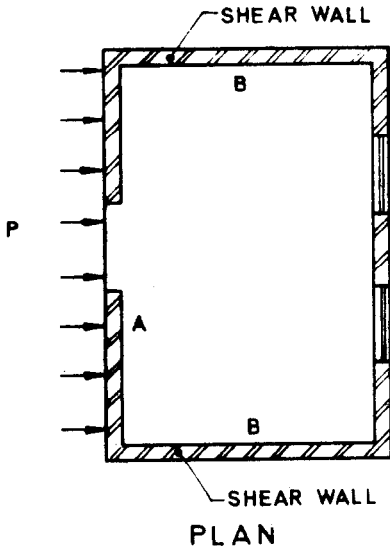

Horizontal force P acting on wall A is resisted by cross walls B which act as shear wall.

FIG. E-7 SHEAR WALL

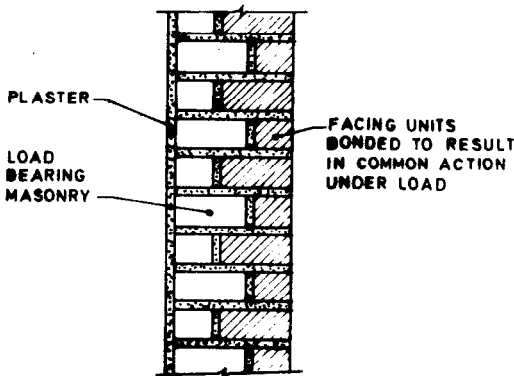

FIG. E-8 FACED WALL

adopting cellular type of plan, reducing storey heights, keeping openings away from intersections of walls, limiting spans of rooms and size of openings, designing floor and roof slabs so as to distribute loads evenly on various walls, and using selected bricks in the lower one or more storeys, etc.

- iv) When building with stone as masonry unit in courses, minimum thickness of walls from practical considerations has to be 30 to 40 cm depending upon type and quality of stone used. However, CBRI have innovated a technique of making precast stone blocks for use as masonry units, so that it has become feasible to build stone masonry walls of 20 to 25 cm thickness, resulting in economy in cost (see 1.3.7 of Part 2).
- v) As a general rule, apart from strength of masonry units and grade of mortar,

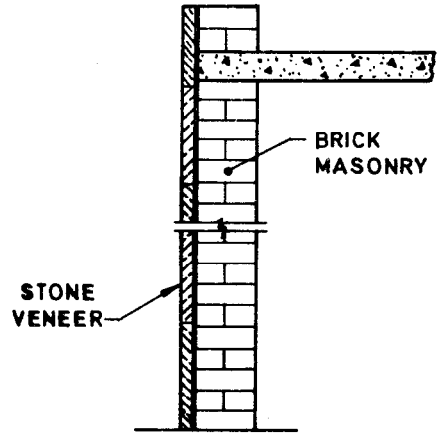

FIG. E-9 VENEERED WALL

strength of masonry depends on surface characteristics and uniformity of size and shape of units as well as certain properties of mortar. Units which are true in shape and size, can be laid with comparatively thinner joints, thereby resulting in higher strength. For this reason, use of A grade bricks gives masonry of higher strength as compared to that with B grade bricks, even though crushing strength of bricks of the two grades may be same. For similar reasons ashlar stone masonry which uses accurately dressed and shaped stones is much stronger than ordinary coursed stone masonry.

- vi) For detailed information on various masonry units reference may be made to 1.3 of Part 2.

3.1.1 Bond between mortar and masonry units depends on suction rate of masonry units. Masonry units, which have been previously used in masonry would not possess adequate suction rate and may not develop normal bond and compressive strengths when reused. It is therefore not advisable to reuse such units in locations where stress in masonry is critical.

3.2. Mortar

- i) Particulars of mortars for masonry are contained in IS 2250 : 1981⁵. Important requirements, characteristics and properties of commonly used mortars are summarised below for ready information. For more detailed information on mortars reference may be made to 1.4 of Part 2 of this Handbook.
- ii) Requirements of a good mortar for masonry are strength, workability, water retentivity and low drying shrinkage. A strong mortar will have adequate crushing strength as well as adequate tensile and shear strength. It is necessary that mortar should attain initial set early enough to

enable work to proceed at a reasonable pace. At the same time it should gain strength within reasonable period so that masonry is in a position to take load early. A workable mortar will hang from the trowel and will spread easily. A mortar with good water retentivity will not readily lose water and stiffen on coming in contact with masonry units, and will remain plastic long enough to be easily adjusted in line and level. This property of good water retentivity will enable the mortar to develop good bond with masonry units and fill the voids, so that masonry has adequate resistance against rain-penetration.

iii) Mortars are intimate mixtures of some cementing materials, such as cement, lime and fine aggregate (such as sand, burnt clay/surkhi, cinder, etc). When only fat lime is used, which sets very slowly through the process of carbonation, it becomes necessary, for the sake of better strength, to use some pozzolanic material, such as burnt clay/surkhi or cinder. Plasticizers are used in plain cement-sand mortars to improve workability. Mortars could be broadly classified as cement mortars, lime mortars and cement-lime mortars. Main characteristics and properties of these three categories of mortars are as under:

a) *Cement mortars*—These consist of cement and sand, varying in proportion from 1 : 8 to 1 : 3, strength and workability improving with the increase in the proportion of cement. Mortars richer than 1 : 3 are not used in masonry because these cause high shrinkage and do not increase in strength of masonry. Mortars leaner than 1 : 5 tend to become harsh and unworkable and are prone to segregation. Cement mortars set early and gain strength quickly. Setting action of mortar is on account of chemical changes in cement in combination with water, and thus these mortars can set and harden in wet locations. In case of lean mortars, voids in sand are not fully filled, and therefore, these are not impervious. Rich mortars though having good strength have high shrinkage and are thus more liable to cracking.

b) *Lime mortars*—These consist of intimate mixtures of lime as binder and sand, burnt clay/surkhi, cinder as fine aggregate in the proportion 1 : 2 to 1 : 3. As a general rule, lime mortars gain strength slowly and have low ultimate strength. Mortars using hydraulic lime attain somewhat better strength than those using fat lime. In fact, lime mortars using fat lime do not harden at all in wet locations. Properties

of mortar using semi-hydraulic lime are intermediate between those of hydraulic and fat lime mortars. When using fat lime, it is necessary to use some pozzolanic material such as burnt clay/surkhi or cinder to improve strength of the mortar. The main advantage of lime mortar lies in its good workability, good water retentivity and low shrinkage. Masonry in lime mortar has, thus, better resistance against rain-penetration and is less liable to cracking, though strength is much less than that of masonry in cement mortar.

c) *Cement-lime mortars*—These mortars have the good qualities of cement as well as lime mortars, that is, medium strength along with good workability, good water retentivity, freedom from cracks and good resistance against rain-penetration. Commonly adopted proportions of the mortar (cement : lime : sand) are 1 : 1 : 6, 1 : 2 : 9 and 1 : 3 : 12. When mix proportion of binder (cement and lime) to sand is kept as 1 : 3, it gives a very dense mortar since voids of sand are fully filled.

iv) Mortar for masonry should be selected with care keeping the following in view. It should be noted that cement-lime mortars are much better than cement mortars for masonry work in most of the structures.

a) If binder contains more of cement and less of lime, it develops strength early, and is strong when matured. A rich cement mortar is needed, firstly, when masonry units of high strength are used so as to get strong masonry; secondly, when early strength is necessary for working under frosty conditions; and thirdly, when masonry is in wet location as in foundation below plinth, where a dense mortar being less pervious can better resist the effect of soluble salts.

b) An unnecessarily strong mortar concentrates the effect of any differential movement of masonry in fewer and wider cracks while a weak mortar (mortar having more of lime and less of cement) will accommodate movements, and cracking will be distributed as thin hair cracks which are less noticeable. Also stresses due to expansion of masonry units are reduced, if a weak mortar is used. Lean mortars of cement alone are harsh, pervious and less workable. Thus when strong mortars are not required from considerations of strength or for working under frosty conditions or for work in wet locations, it is preferable to use composite mortars of cement, lime and sand, in appropriate proportions. Figure E-10 based on BRS

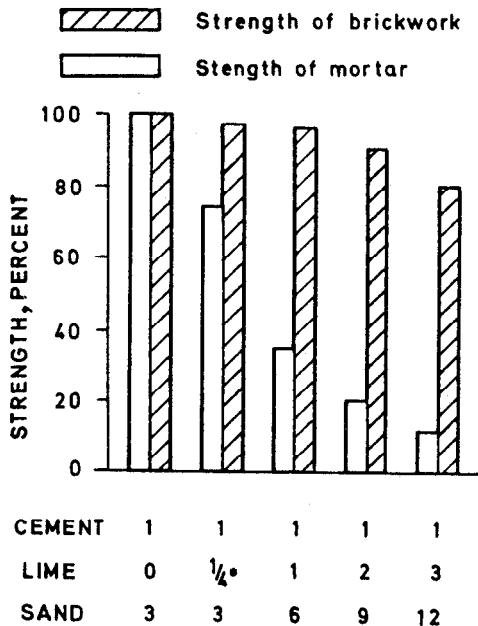

MORTAR RATIO BY VOLUME

Effects of mortar mix proportions on the crushing strengths of mortar and brickwork built with medium strength bricks.

Strengths are shown relative to the strength of a 1 : 3 cement-sand mortar and the brickwork built with it.

FIG. E-10 RELATION BETWEEN STRENGTH OF BRICKWORK AND STRENGTH OF MORTAR

Digest 61⁶ illustrates the relation between strength of mortar and brickwork for a number of mortar mixes when bricks of medium strength (20 to 35 N/mm² according to British Standards) are used. As the proportion of lime in mortar is increased, though mortar loses strength, reduction in strength of brickwork is not much.

c) It has been observed from experimental results that lime-based mortars give higher ratio of strength of brickwork to mortar as compared to non-lime mortars. This can be explained as follows: Normally brickwork fails under a compressive load on account of vertical tensile splitting, for which bond strength of mortar is more important than its compressive strength. Since lime-based mortars have much higher bond strength, as compared to cement mortars, the former produce brickwork of higher strength. Table E-1 giving test results abstracted from SIBMAC proceedings⁷ illustrates this point very clearly.

Table E-1 Effect of Mortar Mix on Strength of Brickwork [Using Clay Brick of Strength 32.7 N/mm² (4 750 lbf/in²)]

Mortar Mix (Cement: Lime: Sand)	Mortar Compressive Strength (28 Days) X	Brickwork Compressive Strength (28 Days) Y	Ratio $\frac{Y}{X}$
(1)	(2)	(3)	(4)
	n/mm ² (lbf/in ²)		
1 : 1/4 : 3	17.8 (2 590)	8.9 (1 290)	0.50
1 : 1/2 : 4 1/2	10.8 (1 570)	9.3 (1 345)	0.86
1 : 1 : 6	4.7 (680)	8.5 (1 235)	1.82
1 : 2 : 9	1.7 (245)	4.6 (660)	2.69

NOTE—Lime used was in the form of well matured putty.

v) Optimum mortar mixes from consideration of maximum strength of brickwork for various brick strengths based on Digest No. 61⁶ (Second Series) and Table 1 of the Code, are given in Table E-2 for general guidance.

Table E-2 Optimum Mortar Mixes for Maximum Masonry Strength with Bricks of Various Strengths

Brick Strength	Mortar Mix (By Volume) (Cement : Lime : Sand)	Mortar Type
(1)	(2)	(3)
(N/mm ²)		
Below 5	1 : 0 : 6 1 : 2C : 9 0 : 1A : 2-3	M2
5-14.9	1 : 0 : 5 1 : ic : 6	M1
15-24.9	1 : 0 : 4 1 : 1/2C : 4 1/2	H2
25.0 or above	1 : 0-1/4C : 3	H1

NOTE—Lime of grade B can be used as an alternative to lime C.

4 DESIGN CONSIDERATIONS

4.1 General

In order to ensure uniformity of loading, openings in walls should not be too large and these should be of 'hole in wall' type as far as possible; bearings for lintels and bed blocks under beams should be liberal in sizes; heavy concentration of loads should be avoided by judicious planning and

sections of load bearing members should be varied where feasible with the loadings so as to obtain more or less uniform stress in adjoining parts of members. One of the commonly occurring causes of cracks in masonry is wide variation in stress in masonry in adjoining parts.

NOTE—A 'hole in wall' type opening is defined as an opening where total width or height of solid masonry around the opening is equal to or greater than the corresponding window dimension.

4.2 Lateral Supports and Stability

4.2.2 Stability

- i) In a masonry structure, there are generally inbuilt, out of balance vertical forces due to imperfection in workmanship and verticality of walls which tend to make the structure unstable. Thus for stability calculations of a lateral support, horizontal force equal to 2.5 percent of all vertical loads acting above that lateral support is assumed for checking the adequacy of that support. This horizontal force is in addition to any other lateral force, namely wind or seismic that the structure may be subjected to.
- ii) It should be borne in mind that assumed horizontal force of 2.5 percent is the total out of balance force due to vertical loads at the particular support and it does not include out of balance forces acting at other supports. Further it should be kept in view that horizontal force of 2.5 percent of vertical loads need not be considered for elements of construction that provide lateral stability to the structure as a whole.

4.2.2.2

- a) Provision in sub-clause (a) is as per 1964 version of IS : 875.
- b) A cross wall acting as a stiffening wall provides stability to the wall at its junction with the cross wall thereby resisting movement of wall at horizontal intervals and sharing a part of the lateral load. Further in conjunction with the floor supported on the wall, it resists horizontal movement of the top of the wall. For the first mode of stiffening, it is necessary that cross wall is built jointly with the load bearing wall or is adequately anchored to it and there should be no opening in the cross wall close to its junction with the main wall (refer clause 4.2.2.2(b) of the Code); for the second mode, the floor should be capable of acting as a horizontal girder and also the floor should be so connected to the cross walls that lateral forces are transmitted to the cross walls through shear resistance between floor and cross walls.
- c) When bricks of old size that is, 23 × 11.5 × 7.7 cm (FPS System) are used, Table E-3

may be used in place of Table 2 of the Code for buildings up to 3 storeys.

Table E-3 Thickness and Spacing of Stiffening Walls (Brick Size 23 × 11.5 × 7.7 cm)

Sl No.	Thickness of Load Bearing Wall to be Stiffened	Height of Storey	Stiffening Wall	
			Minimum Thickness	Maximum Spacing
(1)	(2)	(3)	(4)	(5)
	(cm)	(m)	(cm)	(m)
1.	11.5	3.25	11.5	4.50
2.	23	3.25	11.5	6.00
3.	34.5 and above	5.00	11.5	8.00

4.2.2.3

- i) Cross walls in conjunction with floors in a building provide stability to the structure against the effect of lateral loads that is, wind, etc. In case of halls, we have only end walls and there are no intermediate cross walls. If hall is longer than 8.0 m, the end walls may not be able to provide adequate stability (depending upon the extent of lateral loads) and therefore, it is necessary to check stability and stresses by structural analysis.
- ii) If roofing over a hall consists of RCC beams and slab, it will be able to function as a horizontal girder for transmitting the lateral loads to the end walls. The long walls will therefore function as propped cantilevers, and should be designed accordingly, providing diaphragm walls, if found necessary. Use of diaphragm walls has been explained in E-5.5.3. Also end walls will be subjected to shear and bending and should be designed for permissible shear and no-tension. It is necessary that RCC slab of the roofing system must bear on the end walls so that lateral load is transmitted to these walls through shear resistance. Method of structural analysis of a hall is illustrated in Solved Example E-11.

4.2.2.4

- i) When a hall or a factory type building is provided with trussed roofing the longitudinal walls cannot be deemed to be laterally supported at the top unless trusses are braced at the tie beam level as shown in Fig. E-11. With braced trusses as lateral supports, longitudinal walls will function as propped cantilevers and should be designed accordingly. Even when designed as propped cantilever, ordinary solid walls may have to be fairly thicker and therefore

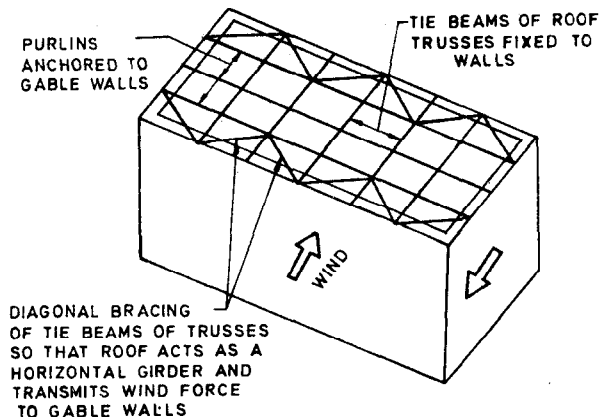

FIG. E-11 DIAGONAL BRACING OF TRUSSES

become uneconomical. In that situation use of diaphragm walls may be resorted to since that can result in considerable economy.

When bricks of size $23 \times 11.5 \times 7.7$ cm (FPS) are used, Table E-4 may be used in place of Table 3 of the Code.

Table E-4 Minimum Thickness of Basement Walls (Brick Size $23 \times 11.5 \times 7.7$ cm)

Sl No.	Minimum Thickness of Basement Wall (cm)	Height of the Ground Above Basement Floor with Wall Loading (Permanent Load) of	
		More than 50 kN/m	Less than 50 kN/m
(1)	(2)	(3)	(4)
	(cm)	(m)	(m)
1.	34.5	2.50	2.00
2.	23	1.35	1.00

NOTE — Permanent load means only dead load and it does not include live load.

4.2.2.7

- a) A free standing wall has no cross walls to give it stability against overturning due to lateral loads that is, wind or seismic loads. It thus acts like a cantilever fixed at the base and free at the top. For design of free standing walls please see comments on E-5.5.2.1 and E-5.5.2.2.
- b) If a wall is intended to retain some dry material and there is no likelihood of any hydrostatic pressure, the design of wall could be based on permissible tension in masonry. A retaining wall intended to support earth should be designed as a gravity structure, placing no reliance on flexural movement of resistance, since water can get access to the back of the wall and

impose pressure through tensile cracks if any and endanger the structure.

4.3 Effective Height

4.3.1 Wall (Table 4—Note 1)

Referring to Note 1 of Table 4, strictly speaking actual height of a wall for the purpose of working out its effective height should be taken to be the clear distance between the supports. However, in the Code it has been given as the height between centres of supports, which is in accordance with the provisions of British Standard CP-111 : Part 2 : 1970² as well as Australian Standard 1640-1974⁸. Since thickness of floors is generally very small as compared to height of floors, this method of reckoning actual height will not make any appreciable difference in the end results. One could, therefore, take actual height as given in the Code or clear distance between supports as may be found convenient to use in calculations.

Wall (Table 4—Note 5)

Implication of this note is that when wall thickness is not less than $2/3$ of the thickness of the pier, a concentrated load on the pier, will be borne by the pier as well as the wall. In this case we may design the element just as a wall supporting a concentrated load, taking advantage of the increase in the supporting area due to the pier projection. In case thickness of wall is less than $2/3$ of the thickness of pier, we have to design the pier just like a column, for which permissible stress is less because of greater effective height and further supporting area will be only that of the pier that is, without getting any benefit in design of the adjoining walls on either side. However in case, the wall and piers are supporting a distributed load, we would get the advantage of stiffening effect of piers as in 4.5.2 of the Code.

4.3.2 Column — In case of columns actual height should be taken as the clear height of a column between supports as illustrated in Fig. E-12.

4.3.3 Opening in Walls

- i) An RCC slab bearing on a wall is assumed to provide full restraint to the wall while a

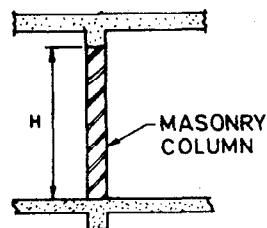

Actual Height H = Clear distance between supports.

FIG. E-12 ACTUAL HEIGHT OF A COLUMN

timber floor comprising timber joints and planking is assumed to provide only partial restraint. The clause makes stipulations for reckoning effective height of columns formed by openings in a wall for the two cases:

- a) when wall has full restraint at top and bottom; and
 - b) when wall has partial restraint at top and bottom. These two cases are illustrated in Fig. E-13.
- ii) In the case of (b) (see Fig. E-13), if height of neither opening exceeds $0.5H$, wall masonry would provide some support to the column formed by openings in the direction parallel to the wall and for this reason effective height for the axis perpendicular to the wall is taken as H and otherwise it is to be taken as $2H$. For the direction perpendicular to the wall, there is a likelihood of a situation when no joist rests on the column formed between the openings and thus effective height is taken as $2H$ that is, for a column having no lateral support at the top.

4.4 Effective Length

When a wall has more than one opening such that there is no opening within a distance of $H/8$ from a cross wall and wall length between openings are not columns by definition, the design of the wall should be based on the value of SR obtained from the consideration of height or length, whichever is less.

4.5 Effective Thickness

4.5.1 In case of masonry using modular bricks, actual thickness of a one-brick wall for design

calculation is taken as 19 cm, though nominal thickness is 20 cm. Similarly in case of brick masonry with bricks of old size (FPS System) actual thickness of one-brick wall would be taken as 22 cm though nominal size of brick is 23 cm.

4.5.2 (See also comments on Note 5 of Table 4.)

When ratio t_p/t_w is 1.5 or less and the wall is having distributed load, Note 5 of Table 4 would be applicable. It follows from this that interpolation of values in Table 6 are valid only when t_p/t_w exceeds 1.5.

4.5.4

- i) It has been observed from tests that a cavity wall is 30 percent weaker than a solid wall of the same thickness as the combined thickness of two leaves of the cavity wall, because bonding action of ties cannot be as good as that of normal bond in a solid wall. That explains why effective thickness of a cavity wall is taken as two-thirds of the sum of the actual thickness of two leaves.
- ii) In this type of wall either one leaf (inner) or both leaves could be load bearing. In the former case, effective thickness will be two-thirds the sum of the two leaves or the actual thickness of the loaded leaf whichever is more. In the latter case effective thickness will be two-thirds of the sum of thickness of both the leaves, or the actual thickness of the stronger leaf, whichever is more.

4.6 Slenderness Ratio

- i) Under a vertical load a wall would buckle either around a horizontal axis parallel to

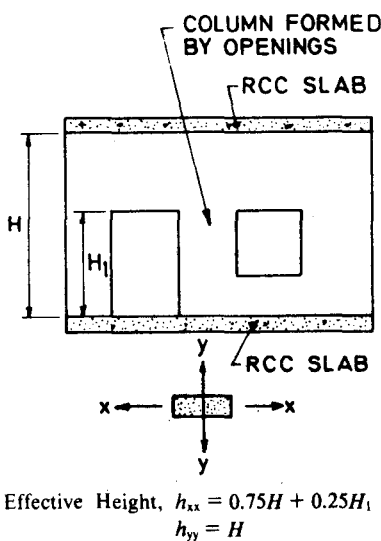

E-13A Walls Having Full Restraint

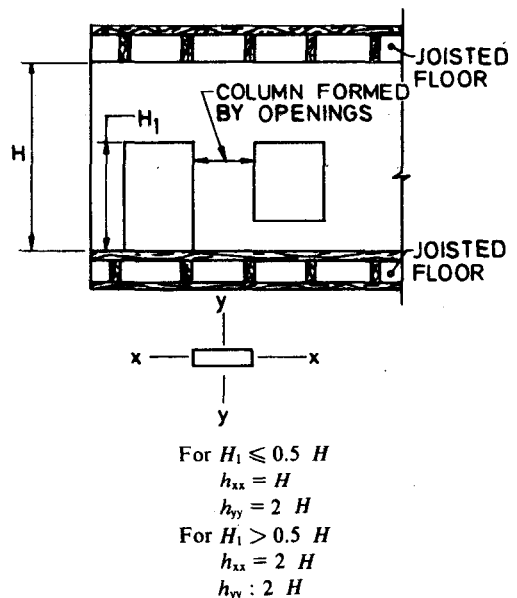

E-13B Walls Having Partial Restraint

FIG. E-13 EFFECTIVE HEIGHT OF WALLS WITH OPENINGS

the length of the wall or around a vertical axis as illustrated in Fig. E-14. Buckling is resisted by horizontal supports such as floors and roofs, as well as by vertical supports such as cross walls, piers and buttresses. Thus capacity of the walls to take vertical loads depends both on horizontal supports that is, floor or roof as well as on vertical supports that is, cross walls, piers and buttresses. However, for the sake of simplicity and erring on safe side, lesser of the two slenderness ratios, namely, one derived from height and the other derived from length is taken into consideration for determining permissible stresses in masonry walls, thus ignoring strengthening effect of other supports.



SECTION

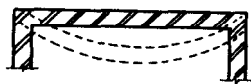

PLAN

E-14A Section of a Wall with Tendency to Buckle Around Horizontal Axis Under Vertical Load

E-14B Plan View of a Wall with Tendency to Buckle Around Vertical Axis Under Vertical Load

FIG. E-14 BUCKLING OF WALLS

- ii) In case of columns, there will be two values of SR as illustrated in Fig. 8 of the Code. For the purpose of design, higher of the two values is taken into account since column will buckle around that axis with reference to which the value of SR is critical, that is, greater.
- iii) Load carrying capacity of a masonry member depends upon its slenderness ratio. As this ratio increases, crippling stress of the member gets reduced because of limitations of workmanship and elastic instability. A masonry member may fail, either due to excessive stress or due to buckling (see Fig. E-22). According to Sahlin (p. 1003)¹, for materials of normal strength with SR less than 30, the load carrying capacity of a member at ultimate load is limited by stress, while for higher value of SR failure is initiated by buckling. Further, mode of failure of a very short member having h/t ratio of less than 4 is

predominantly through shear action, while with $h/t = 4$ or more, failure is by vertical tensile splitting. From consideration of structural soundness and economy of design, most codes control the maximum slenderness ratio of walls and columns so as to ensure failure by excessive stress rather than buckling.

- iv) Limiting values of SR are less for masonry built in lime mortar, as compared to that built in cement mortar, because the former, being relatively weaker, is more liable to buckling. Similarly, values of maximum SR are less for taller buildings since imperfections in workmanship in regard to verticality are likely to be more pronounced in case of taller buildings. Limiting values of SR for column is less than that of walls because a column can buckle around either of the two horizontal axes, while walls can buckle around horizontal axis only.
- v) Since slenderness of a masonry element increases its tendency to buckle, permissible compressive stress of an element is related to its slenderness ratio and is determined by applying Stress reduction factor (k_s) as given in Table 9 of the Code. Values of Stress reduction factor have been worked out (see Appendix B of BS 5628⁹) by taking into consideration eccentricity in loading because of slenderness. Strictly speaking full value of stress reduction factor is applicable only for central one-fifth height of the member. In practice however for the sake of simplicity in design calculations, stress reduction factor is applied to the masonry throughout its storey height (Note 3 under Table 9 of the Code is an exception) and for designing masonry for a particular storey height, generally stress is worked out at the section just above the bottom support assuming it to be maximum at that section. Theoretically critical section in a storey occurs at a height $0.6 H$ above the bottom support as explained later in E-4.7. Thus provisions of the Code and the design procedure in question, as commonly followed, is an approximation, that errs on the safe side.
- vi) Advantage of Note 3 under Table 9 of the Code is taken when considering bearing stress under a concentrated load from a beam. Bearing stress is worked out immediately below the beam and this should not exceed the Basic compressive stress of masonry (see Table 8 of the Code). Also stress in masonry is worked out at a depth of $\frac{H}{8}$ from the bottom of the beam. This should not exceed the permissible compressive stress in masonry.

If actual stress exceeds allowable stress in either case, a concrete bed block is provided below the beam (see Solved example E-9 for design of a Bed block).

- vii) In accordance with 5.4.1.5 of the Code, some increase in permissible compressive stress is allowed for concentrated loads which are concentric. For checking bearing stress under such a load, however, some authorities on masonry recommend a conservative approach—that is, either to take advantage of Note 3 of Table 9 of the Code or to take advantage of provisions of 5.4.1.5 of the Code but do not apply both the provisions of the code at the same time. In this connection reference may be made to commentary portion 4.13.6 of the Australian Standard 1640-1974* which is appended to that standard.

4.7 Eccentricity

- i) Eccentricity of vertical loading on a masonry element increases its tendency to buckling and reduces its load carrying capacity; its effect is thus similar to that of slenderness of the member. Thus combined effect of slenderness and eccentricity is taken into consideration in design calculations by the factor known as Stress reduction factor (*ks*) as given in Table 9 of the Code.
- ii) Eccentricity caused by an eccentric vertical load is maximum at the top of a member, that is, at the point of loading and it is assumed to reduce linearly to zero at the bottom of the member that is, just above the bottom lateral support, while eccentricity on account of slenderness of a member is zero at the two supports and is maximum at the middle. Taking the combined effect of eccentricity of loading and slenderness critical stress in masonry occurs at a section $0.6H$ above the bottom support as shown in Fig. E-15.

For the sake of simplicity, however, in design calculations, it is assumed that

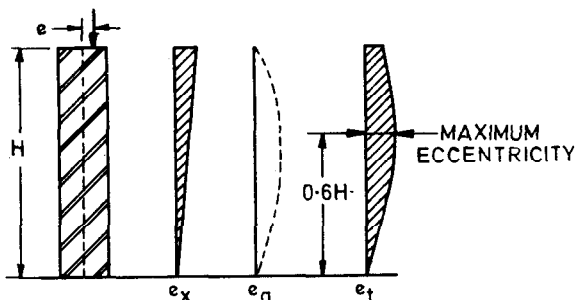

e_x = eccentricity due to loading.
 e_s = eccentricity due to slenderness.
 e_t = combined eccentricity which is maximum at $0.6H$ from bottom support.

FIG. E-15 ECCENTRICITY OF LOADING ON A WALL

critical section in a storey height is at the top of bottom support and masonry is designed accordingly. In other words the design method commonly adopted includes extra self weight of $0.6H$ of the member and thus errs on the safe side to some extent. In view of the fact that design calculations for masonry are not very precise, the above approximation is justified.

5 STRUCTURAL DESIGN

5.1 General

- i) Some general guidance on the design concept of load bearing masonry structures is given in the following paragraphs.
- ii) A building is basically subjected to two types of loads, namely:
 - a) vertical loads on account of dead loads of materials used in construction, plus live loads due to occupancy; and
 - b) lateral loads due to wind and seismic forces. While all walls in general can take vertical loads, ability of a wall to take lateral loads depends on its disposition in relation to the direction of lateral load. This could be best explained with the help of an illustration.

In Fig. E-16, the wall *A* has good resistance against a lateral load, while wall *B* offers very little resistance to such load. The lateral loads acting on the face of a building are transmitted through floors (which act as horizontal beams) to cross walls which act as horizontal beams) to cross walls which act as shear walls. From cross walls, loads are transmitted to the foundation. This action is illustrated in Fig. E-17. Stress pattern in cross walls due to lateral loads is illustrated in Fig. E-18.

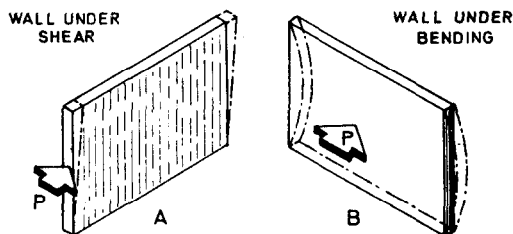

Resistance of brick wall to take lateral loads is greater in case of wall *A* than that in case of wall *B*.

FIG. E-16 ABILITY OF A WALL TO TAKE LATERAL LOADS

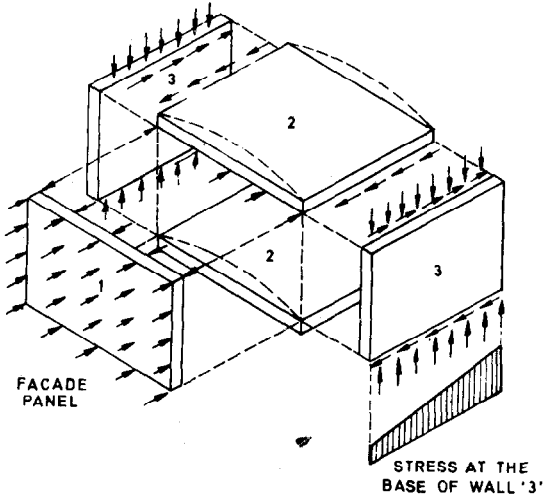

Wind load on the facade wall 1 is transferred via floor slabs 2 to the cross walls 3 and thence to ground.

The strength and stiffness of 2 that is floors as horizontal girder is vital; floors of lightweight construction should be used with care.

FIG. E-17 FUNCTION OF LATERAL SUPPORT TO WALL

iii) As a result of lateral load, in the cross walls there will be an increase of compressive stress on the leeward side, and

decrease of compressive stress on the windward side. These walls should be designed for 'no tension' and permissible compressive stress. It will be of interest to note that a wall which is carrying greater vertical loads, will be in a better position to resist lateral loads than the one which is lightly loaded in the vertical direction. This point should be kept in view while planning the structure so as to achieve economy in structural design.

iv) A structure should have adequate stability in the direction of both the principal axes. The so called 'cross wall' construction may not have much lateral resistance in the longitudinal direction. In multi-storeyed buildings, it is desirable to adopt 'cellular' or 'box type' construction from consideration of stability and economy as illustrated in Fig. E-19.

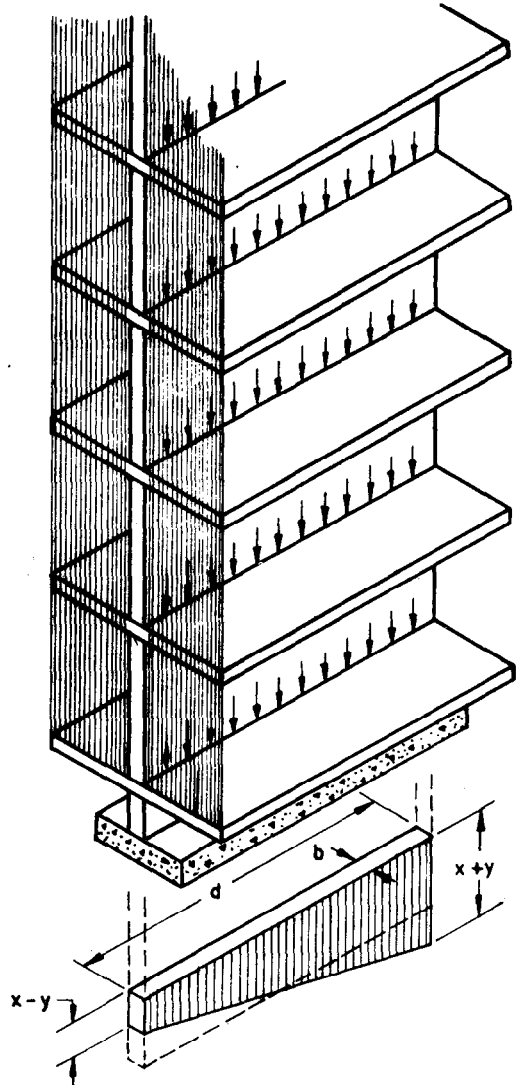
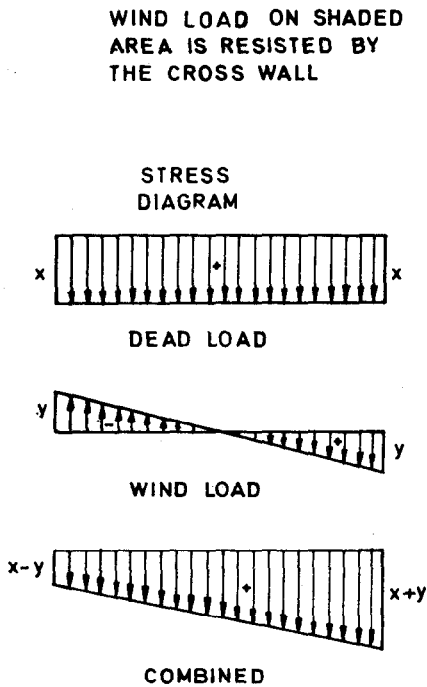
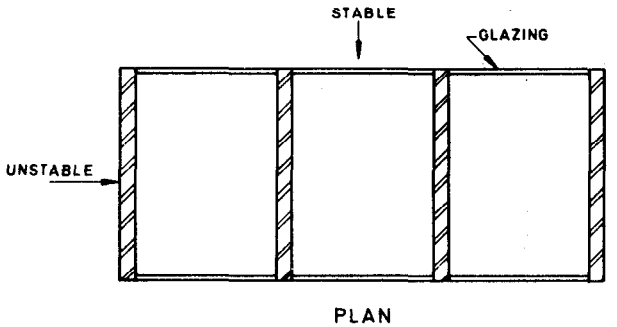
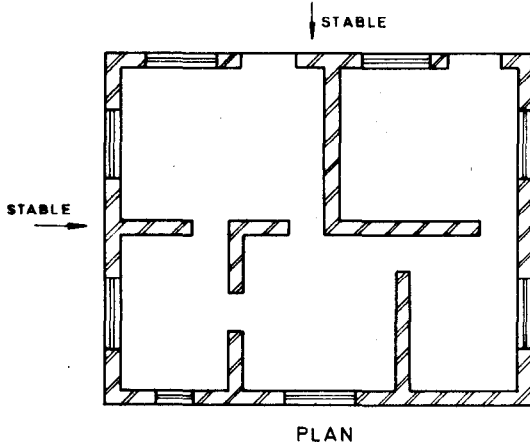

FIG. E-18 STRESS PATTERN IN CROSS WALL ACTING AS SHEAR WALL



E-19 A CROSS WALL CONSTRUCTION-UNSTABLE IN LONGITUDINAL DIRECTION



E-19 B CELLULAR OR BOX TYPE CONSTRUCTION STABLE IN BOTH DIRECTIONS

FIG. E-19 STABILITY OF CROSS WALL AND CELLULAR (BOX TYPE) CONSTRUCTION

- v) Size, shape and location of openings in the external walls have considerable influence on stability and magnitude of stresses due to lateral loads. This has been illustrated in Fig. E-20.
- vi) If openings in longitudinal walls are so located that portions of these walls act as flanges to cross walls, the strength of the cross walls get considerably increased and structure becomes much more stable, as will be seen from Fig. E-21.
- vii) Ordinarily a load-bearing masonry structure is designed for permissible compressive and shear stresses (with no tension) as a vertical cantilever by accepted principles of engineering mechanics. No moment transfer is allowed for, at floor to wall connections and lateral forces are assumed to be resisted by diaphragm action of floor/roof slabs, which acting as horizontal beams, transmit lateral forces to cross walls in proportion to their relative stiffness (moment of inertia). Various modes of failure of masonry are illustrated in Fig. E-22.

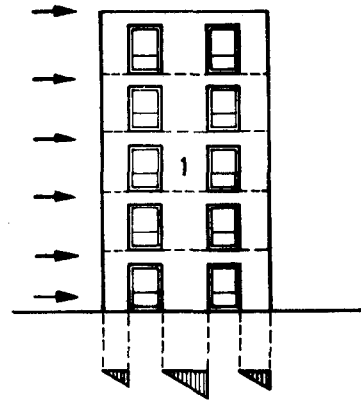

This wall will not resist lateral loading as successfully as wall 2; it tends to act as three separate short lengths rather than one.

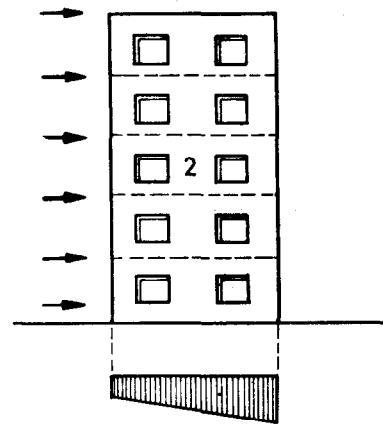

This wall will tend to act as one long portion of brickwork and will be more resistant to lateral loading.

FIG. E-20 EFFECT OF OPENINGS ON SHEAR STRENGTH OF WALLS

- viii) For working out stresses in various walls, it is faster to tabulate stresses floor-wise for such walls carrying greater loads. Computations for vertical loads and lateral loads are made separately in the first instance, and the results from the two computations are superimposed to arrive at the net value of stresses.
- ix) In any particular floor, from practical considerations, generally, quality of bricks and mix of mortar is kept the same throughout. Also in the vertical direction change in thickness of walls is made only at floor levels.

5.3 Load Dispersion

5.3.1 General— Pre-1980 version of the Code provided for dispersion of axial loads applied to a

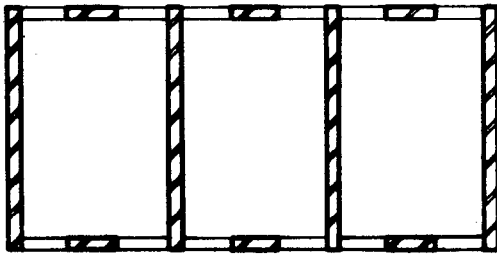

STRAIGHT WALL
STRENGTH INDEX = 1

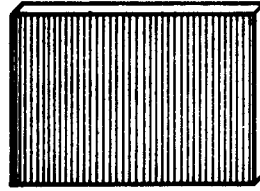

E-21A BRICKWORK RESISTING SHEAR
(FOR ALL FOUR WALLS)

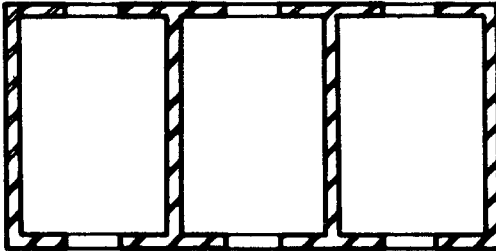

FLANGED WALL
STRENGTH INDEX = 3

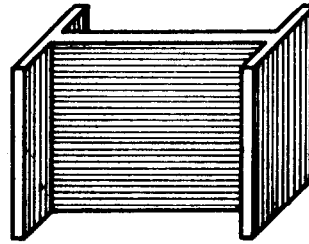

E-21B BRICKWORK RESISTING SHEAR
(FOR TWO CENTRAL WALLS)

FIG. E-21 EFFECT OF FLANGES ON SHEAR STRENGTH OF A CROSS WALL

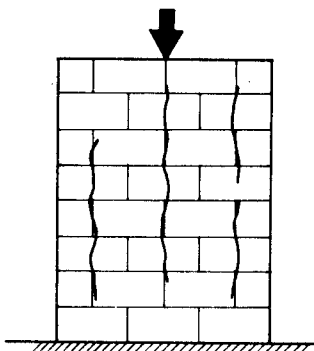

E-22A TENSILE SPLITTING OF A WALL UNDER VERTICAL COMPRESSIVE LOAD

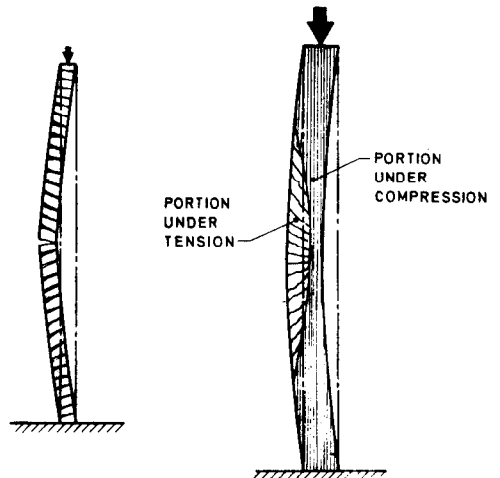

E-22B BUCKLING OF A WALL UNDER VERTICAL COMPRESSIVE LOAD

FIG. E-22 VARIOUS MODES OF FAILURE OF MASONRY — (Contd)

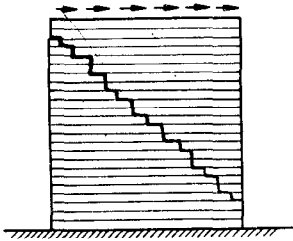

E-22C SHEAR FAILURE OF A MASONRY CROSS WALL UNDER LATERAL LOADING

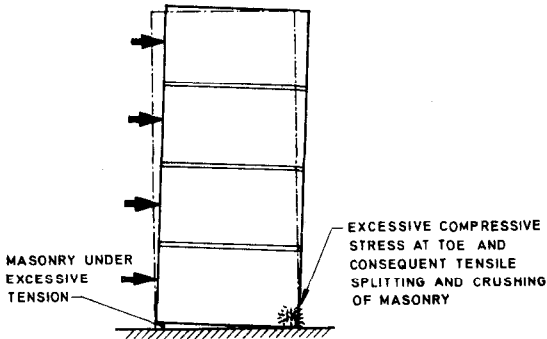

E-22D EXCESSIVE COMPRESSIVE STRESS IN CROSS WALLS RESULTING IN CRUSHING OF MASONRY AT THE TOE UNDER LATERAL LOADING

FIG. E-22 VARIOUS MODES OF FAILURE OF MASONRY

masonry wall at an angle of 45° to the vertical, distributed uniformly through a triangular section of the wall. This was based on provisions of B. S. CP-III : Part 2 : 1970². According to Brick Institute of America⁴, though distribution of stress through an angle of 45° is borne out by

experimental studies carried out at the University of Edinburgh, assumption regarding even distribution of stress does not seem to have been fully substantiate. The Institute therefore recommended that angle of distribution of concentrated loads in a masonry wall should not exceed 30 degrees. This recommendation is in conformity with provisions of the corresponding German Standard (DIN 1053-1952), Swiss Standard (Technical Standard 113-1965) and the publication: 'Brick and Tile Engineering 1962 by Harry C. Plummer'. In view of the above, angle of dispersion had been changed from 45° to 30° in 1980 version of the Code (see Fig. E-23).

5.3.2 Arching Action

- i) Arching in masonry is a well known phenomenon by which part of the load over an opening in the wall gets transferred to the sides of the opening. For good arching action masonry units should have good shear strength and these should be laid in proper masonry bond using a good quality mortar. Further, portions of the wall on both sides of the opening should be long enough [see E-5.3.3(i)] to serve as effective abutments for the arched masonry above the opening since horizontal thrust for the arch is to be provided by the shear resistance of the masonry at the springing level on both sides of the opening. If an opening is too close to the end of a wall, shear stress in masonry at springing level of imaginary arch may be excessive and thus no advantage can be taken of arching in masonry for design of lintels.
- ii) To explain the effect of arching on design of lintels and stress in masonry, let us

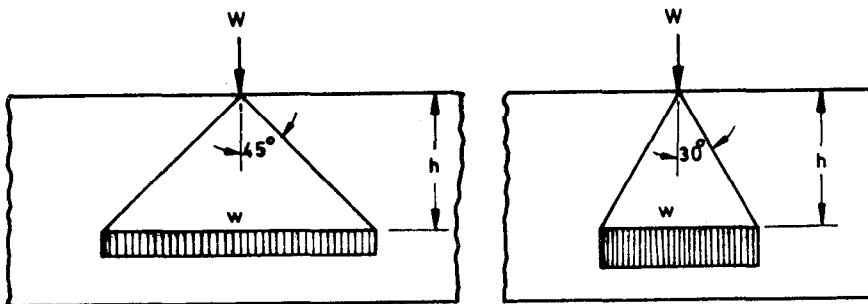

ANGLE OF DISPERSAL 45°

$$w = \frac{W}{2h \tan 45^\circ}$$

ANGLE OF DISPERSAL 30°

$$w = \frac{W}{2h \tan 30^\circ}$$

W - Concentrated load
 w - Distributed load after dispersal at depth h from plane of application of concentrated load

FIG. E-23 DISPERSAL OF CONCENTRATED LOAD IN MASONRY

consider a wall of length AB with an opening of effective span $PQ = L$ as shown in Fig. E-24 PRQ is an equilateral triangle with PQ as its base.

Because of arching action, loads of floor and masonry above the equilateral triangle get transferred to the sides of the wall. Therefore lintel at PQ is designed for load of masonry contained in the triangle PRQ .

To work out approximate stress in masonry in various stretches, it is assumed that:

- a) load from the lintel gets uniformly distributed over the supports,
- b) masonry and floor loads above the triangle PRQ get uniformly distributed over the stretches of masonry CD and EF at the soffit level of the lintel, CD and EF being limited in length to $L/2$ and over the stretches GH and JK at the floor level, limited in length to L or $\frac{L-H}{2}$ whichever is less, H being the height of top of the opening from the floor level.

In case some other opening occurs between the lintel and horizontal plane 25 cm above the apex R of the triangle,

arching action gets interrupted because of inadequate depth of masonry above the triangle to function as an effective arching ring. Also if there is some other load between the lintel and horizontal plane 25 cm above the apex R of the triangle, loading on the lintel gets affected.

- iii) In case of buildings of conventional design with openings of moderate size which are reasonably concentric, some authorities on masonry recommend a simplified approach for design. In simplified approach, stress in masonry at plinth level is assumed to be uniformly distributed in different stretches of masonry, taking loadings in each stretch as indicated in Fig. E-25 without making any deduction in weight of masonry for the openings. It is assumed that the extra stresses obtained in masonry by making no deduction for openings, compensates more or less for concentrations of stresses due to openings. This approach is of special significance in the design of multistoreyed load-bearing structure where intervening floor slabs tend to disperse the upper storey loads more or less uniformly on the inter-opening spaces below the slabs and thus at plinth level stress in masonry, as worked out by the above approach is expected to be reasonably accurate.

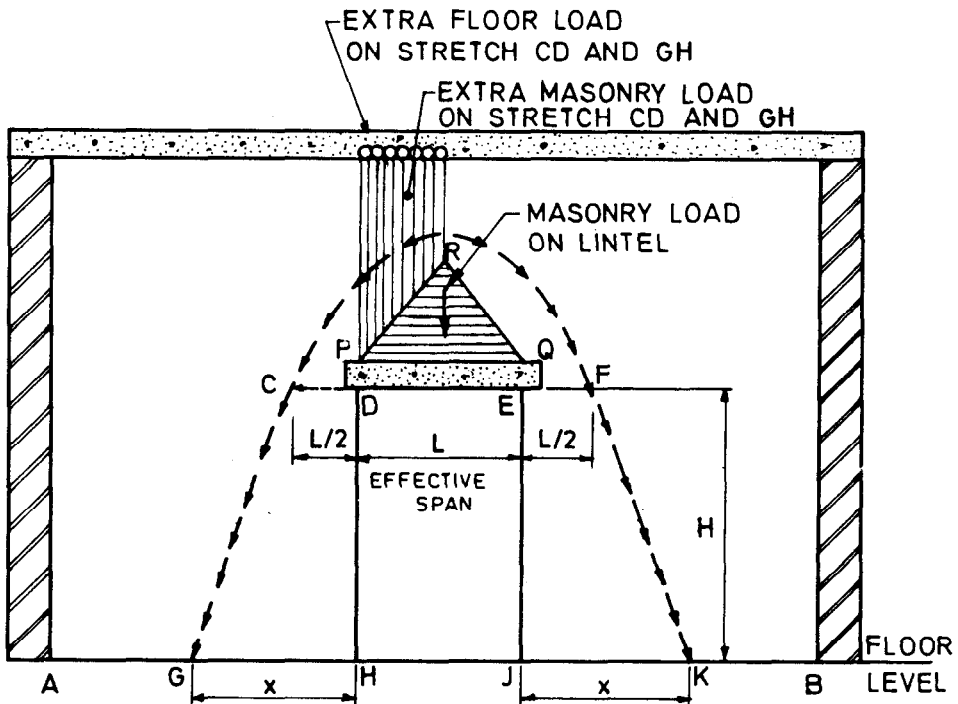

$$x = L \text{ OR } \frac{L+H}{2}, \text{ whichever is less.}$$

FIG. E-24 ARCHING ACTION IN MASONRY

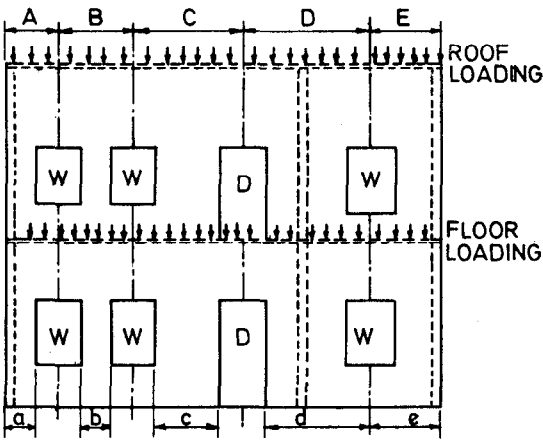

NOTE—Loads on Sections A to E of the building are considered to be acting on wall lengths a to e respectively.

FIG. E-25

5.3.3 Lintels

i) Lintels over openings are designed taking into consideration arching action in masonry where feasible as explained earlier. It is a common practice to assume that length of walls on both sides of an opening should be at least half the effective span of the opening for transfer of load to sides by arch action. In case it is less, lintel should be designed for full load over the opening regardless of the height of the floor slab as shown in Fig. E-26A.

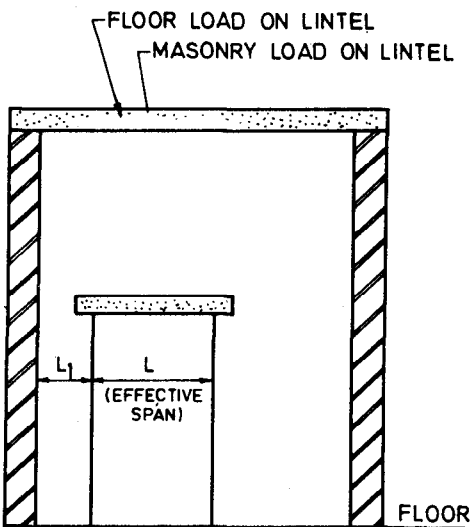

E-26A Effective Load when

$$L_1 < \frac{L}{2}$$

ii) When location and size of opening is such that arching action can take place, lintel is designed for the load of masonry included in the equilateral triangle over the lintel as shown in Fig. E-26B. In case floor or roof slab falls within a part of the triangle in question or the triangle is within the influence of a concentrated load or some other opening occurs within a part of the triangle, loading on the lintel will get modified as given in (iii), (iv) and (v).

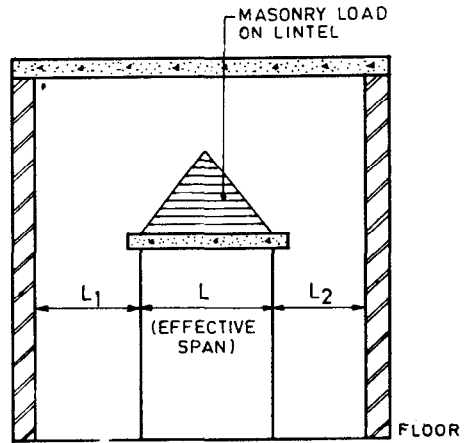

E-26B Effective Load when L_1 and $L_2 \geq L/2$ and Floor/Roof Slab does not Intercept the Equilateral Triangle Over the Lintel

iii) When stretches of wall on sides are equal to or greater than $L/2$ and equilateral triangle above the lintel is intercepted by the floor/roof slab, the lintel is designed for load of masonry contained in the equilateral triangle plus load from the floor falling within the triangle as shown in Fig. E-26C.

iv) When stretches of wall on the sides of the opening are equal to or greater than $L/2$ with the equilateral triangle over the lintel intercepted by floor slab and another opening comes within the horizontal plane 25 cm above the apex of the triangle, lintel is to be designed for loads shown in Fig. E-26D.

v) When any other load is coming between the lintel and horizontal plane 25 cm above the apex of the equilateral triangle over the lintel, the latter is designed for the loads as shown in Fig. E-26E.

vi) It may be clarified that in fact load coming on a lintel is indeterminate and the above suggestions for the design of lintels are based on empirical rules derived from

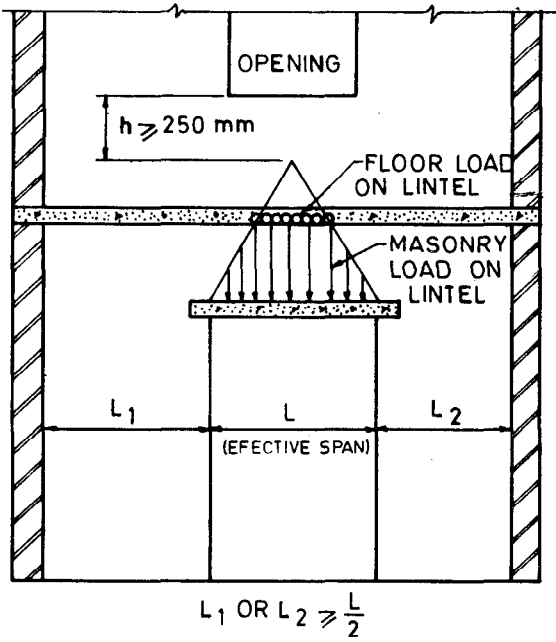

$$L_1 \text{ OR } L_2 \geq \frac{L}{2}$$

E-26C Effective Load when L_1 and $L_2 \geq L/2$, and Equilateral Triangle Over the Lintel is Intercepted by Floor Slab Above with no Other Opening to Intercept Arch Action

experience and general principles of engineering.

- vii) Economy in the design of lintels may be effected by taking advantage of composite action between lintel and the masonry above it. For this purpose centering of the lintel should not be removed till both masonry (up to 25 cm above the apex of equilateral triangle above the lintel) and RCC of the lintel have gained sufficient strength so as to be able to bear stresses in the composite beam having masonry in compressive zone and RCC lintel in the tensile zone. Behaviour of composite beam in this case is analogous to that of grade beam in pile foundation.

From experimental research, it has been observed that single brickwidth walls for vertical loads are stronger than multiple brick width walls as can be readily seen from the test results reproduced below (Swiss results quoted by Mark¹⁰):

Wall Construction	Wall Thickness cm (in)	Relative Strength
(1)	(2)	(3)
Single brick-width	12.7 (5)	1.00
-do-	15.2 (6)	0.89
-do-	17.8-25.4 (7-10)	0.80

(1)	(2)	(3)
Multiple brick-width	25.4-38.1 (10-15)	0.68

Theoretical explanation for the above behaviour of masonry is that presence of vertical joints, which have a much lower lateral tensile strength, reduces the compressive stress of masonry under axial loading. Thus greater is the frequency of vertical joints, lesser is the compressive strength of masonry. Thus a 20/23 cm thick brick wall (one brick-length) is weaker than a 10/11.5 cm brick wall of single brick-width because of presence of vertical joints in both the directions in the former. Table 8 of the Code for Basic Compressive Strength of Masonry, which is based on British Standard², may be presumed to hold good for one brick-length or thicker walls and thus in case of half-brick load bearing walls some increase in Basic stress may be permitted at the discretion of the designer.

For similar reasons, concrete blockwork masonry which has proportionately lesser vertical joints is stronger than brickwork masonry⁹, though the Code at present does not make any stipulation about it. In other countries, for high rise load-bearing structure advantage of this phenomenon is taken by making use of 'through-wall units' of burnt clay, thereby attaining higher permissible strength for brick masonry, and making it feasible to go high with single unit thick walls.

5.4 Permissible Stresses

5.4.1 Permissible Compressive Stress

5.4.1.1 Stress reduction factor

When a wall or column is subjected to an axial plus an eccentric load (see Fig. E-27) resultant eccentricity of loading (\bar{e}) may be worked out as follows:

$$W = W_1 + W_2$$

Taking moments about AB,

$$W\bar{e} = W_1 \times O + W_2 e$$

$$\therefore \bar{e} = \frac{W_2 e}{W_1 + W_2}$$

5.4.1.2 Area reduction factor

- i) Provision of Area reduction factor in this Code was originally similar to that in 1970 version of British Standard Code CP III². When the Code was revised in 1980, upper limit of 'small area' was reduced from 0.3 to 0.2 m² based on the provision in BS 5628 Part 1 : 1978⁹.

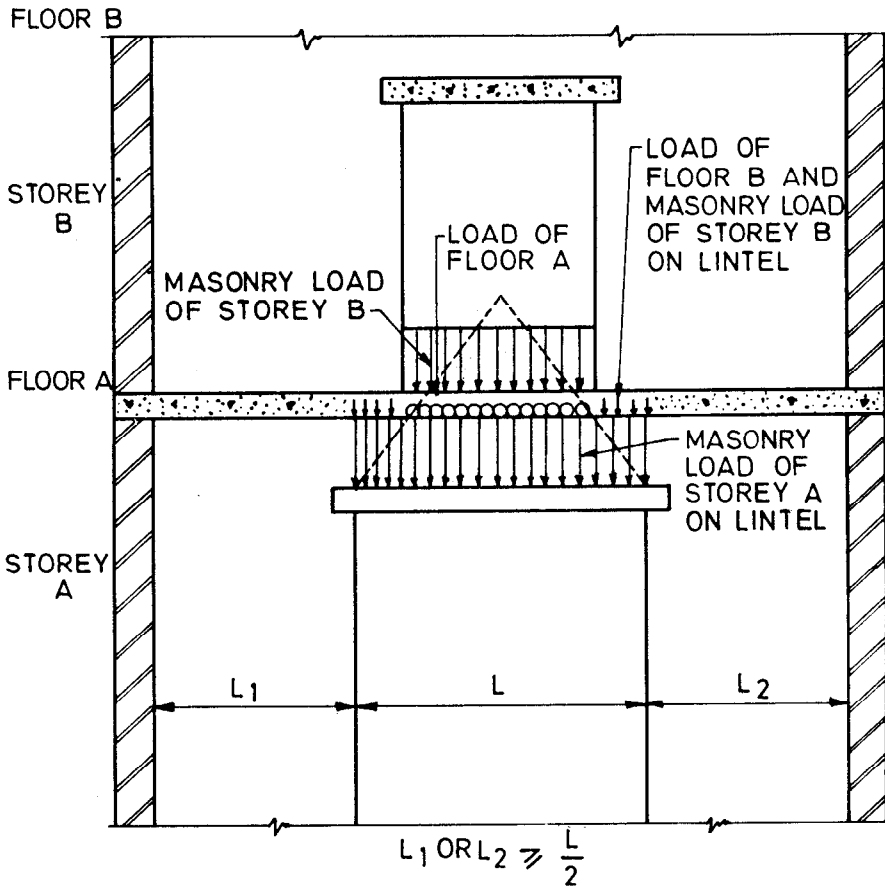

E-26D Effective Load when L_1 and $L_2 \geq L/2$ and Equilateral Triangle Above the Lintel is Within 25 cm (Vertically) of Another Opening in the Upper Storey

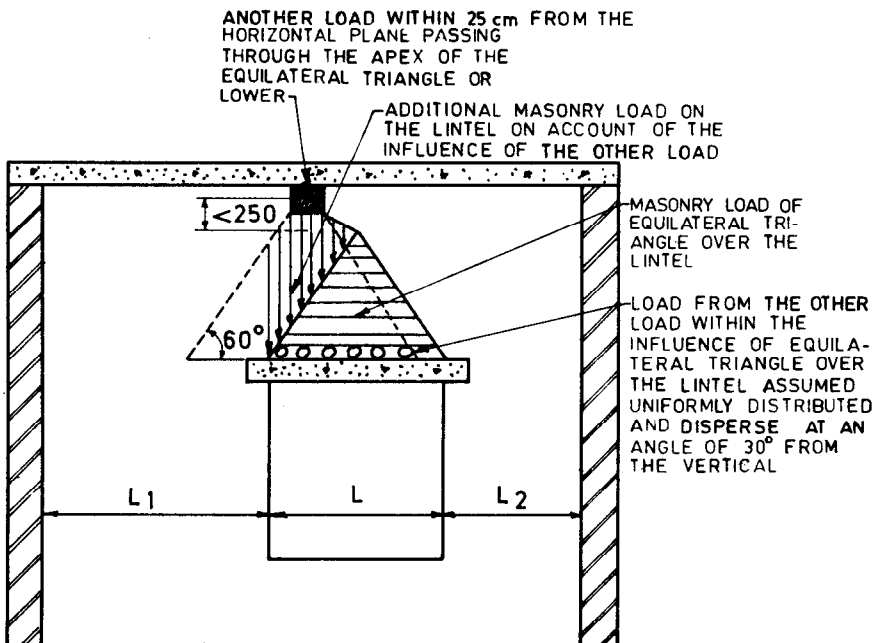

E-26E Effective Load when L_1 and $L_2 \geq L/2$ and the Equilateral Triangle is Within the Influence of Another Load

FIG. E-26 EFFECTIVE LOADS ON LINTELS FOR VARIOUS SITUATIONS

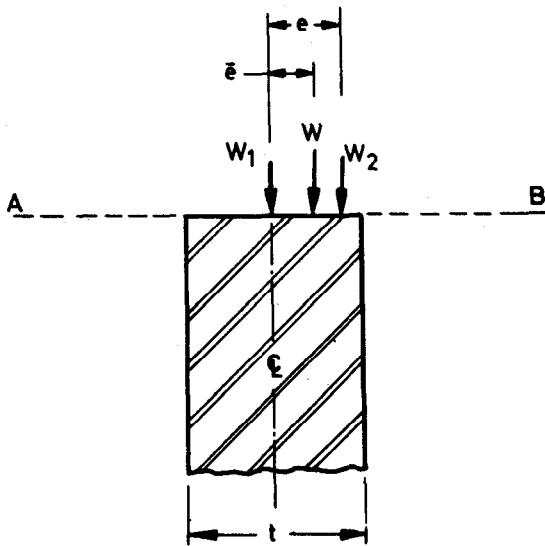

W_1 = axial load.
 W_2 = eccentric load at distance 'e' from centre line.
 W = resultant load at distance 'e-bar' from centre line.
 \bar{e} = resultant eccentricity.

FIG. E-27 RESULTANT ECCENTRICITY

ii) Area reduction factor due to 'small area' of a member is based on the concept that there is statistically greater probability of failure of a small section due to sub-standard units as compared to a large element. However American and the Canadian Codes do not include any provision for smallness of area. The reason for this seems to be that factor of safety/load factors inherent in a Code should be enough to cover the contingency mentioned above for this provision. In the Australian Code (1974)⁸ and draft ISO standard (1987)¹¹ limits for smallness of area in this context are taken 0.13 and 0.10 m², respectively. Strictly speaking necessity for this provision in the Code arises when there is appreciable variation in strength of individual units. In view of the fact that strength of masonry units being manufactured at present in our country can appreciably vary, the necessity for this provision is justified in our code.

5.4.1.3 Shape reduction factor

Shape modification factor is based on the general principle that lesser the number of horizontal joints in masonry, greater its strength or load carrying capacity. It has, however, been found from experimental studies that for units stronger than 15 N/mm², extent of joints in masonry does not have any significant effect on strength of masonry because of use of the comparatively high strength mortar that normally goes with high-strength units.

5.4.1.4 Increase in permissible compressive stresses allowed for eccentric vertical and/or lateral loads under certain conditions

i) Eccentric vertical load (vertical load plus lateral load in case of free standing walls) on masonry causes bending stress in addition to axial stress. It has been found that masonry can take 25 percent greater compressive stress, when it is due to bending than when it is due to pure axial load, because maximum stress in case of bending occurs at the extreme fibres and then it gets reduced linearly while in axial compression, stress is more or less uniform throughout the section. For similar reasons permissible compressive stress in concrete for beams is greater than that in columns subjected to vertical loads. This rule of higher Permissible compressive stress when due to bending can also be explained from the consideration that beyond elastic limit redistribution of stresses takes place because of plasticity and thus stress block is in practice more or less rectangular in shape instead of triangular as is normally assumed in accordance with the elastic theory. This enables the member to take greater load.

ii) When loading on a masonry element has some eccentricity, the Code lays down the design approach for various ranges of eccentricity ratios namely (a) eccentricity ratio of $\frac{1}{24}$ or less; (b) eccentricity ratio exceeding $\frac{1}{24}$ but not exceeding $\frac{1}{6}$, and (c) eccentricity ratio exceeding $\frac{1}{6}$. Basis of the design approach is explained below (see also Fig. E-28).

a) Eccentricity ratio of $\frac{1}{24}$ or less—

Referring to Fig. E-28B, W is total vertical load per unit of wall with resultant eccentricity \bar{e} , t is thickness of wall, f_1 and f_2 are the stresses at the two faces of the wall and f_m is Permissible compressive stress for axial loading.

$$f_1 = \frac{W}{A} + \frac{M}{Z}$$

$$f_2 = \frac{W}{A} - \frac{M}{Z}$$

Substituting values of A , M and Z

$$f_1 = \frac{W}{t} + \frac{W\bar{e} \times 6}{t^2} = \frac{W}{t} \left(1 + \frac{6\bar{e}}{t} \right)$$

$$f_2 = \frac{W}{t} - \frac{W\bar{e} \times 6}{t^2} = \frac{W}{t} \left(1 - \frac{6\bar{e}}{t} \right)$$

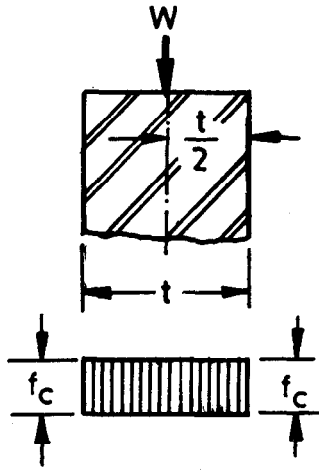

$$e = 0$$

$$W = f_c t$$

FIG. E-28A

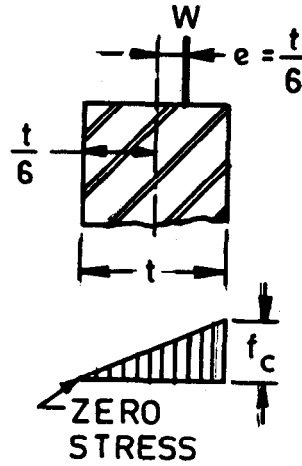

$$\bar{e} = \frac{t}{6}$$

$$f_c = \frac{2W}{\bar{e}t}$$

$$= 1.25 f_c$$

$$W = \frac{1.25 \times t}{2}$$

FIG. E-28D

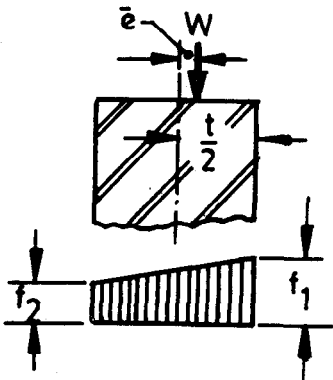

$$e = t/24$$

$$f_1 = 1.25 f_c$$

$$f_2 = 0.75 f_c$$

$$W = f_c t$$

FIG. E-28B

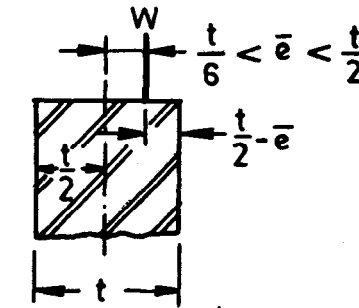

$$\frac{t}{6} < \bar{e} < \frac{t}{2}$$

$$f_c = 1.25 f_c$$

$$= \frac{2W}{3\left(\frac{t}{2} - \bar{e}\right)}$$

FIG. E-28E

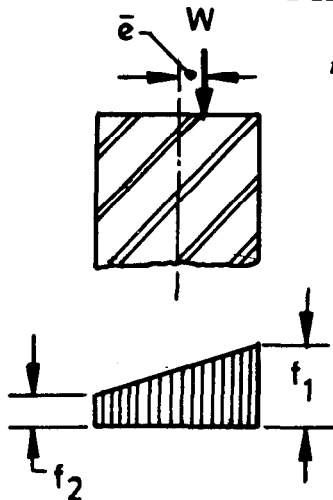

$$\frac{t}{24} < \bar{e} < \frac{t}{6}$$

$$f_1 = 1.25 f_c$$

$$= \frac{W}{t} \left(1 + \frac{6\bar{e}}{t}\right)$$

$$W = \frac{1.25 f_c t}{1 + \frac{6\bar{e}}{t}}$$

FIG. E-28C

W = permissible load per unit length of wall.
 f_c = permissible compressive stress of masonry.
 \bar{e} = resultant eccentricity of loading.
 t = thickness of wall.

FIG. E-28 VARIATION IN STRESS DISTRIBUTION WITH CHANGE IN ECCENTRICITY OF LOADING

for eccentricity ratio $\frac{e}{t} = \frac{1}{24}$, and since $\frac{W}{t}$ is equal to axial compressive stress f_c ,

$$f_1 = \frac{W}{t} \left(1 + \frac{1}{4} \right) = 1.25 f_c$$

$$f_2 = \frac{W}{t} \left(1 - \frac{1}{4} \right) = 0.75 f_c$$

As we allow 25 percent additional compressive stress in case of eccentric loading, it follows that maximum compressive stress (f_1) for eccentricity ratio up to $\frac{1}{24}$ does not exceed axial compressive stress by more than 25 percent which is permitted by the code.

Therefore for eccentricity ratio of $\frac{1}{24}$ or less, it is not necessary to compute and add bending stress to the axial stress. The designer is expected to work out only axial compressive stress for the purpose of design and see that it does not exceed Permissible compressive stress for axial load.

∴ Design load, $W = f_c t$

- b) Eccentricity ratio exceeding $\frac{1}{24}$ but not exceeding $\frac{1}{6}$ (see Fig. E-28C and E-28D)

$$\text{Bending stress} = \frac{We \times 6}{t_2}$$

for eccentricity ratio $\frac{1}{6}$ (substituting in the above equations),

$$f_1 = \frac{W}{t} + \frac{W}{t} = \frac{2W}{t}$$

$$f_2 = \frac{W}{t} - \frac{W}{t} = 0$$

Thus on one face compressive stress gets doubled and on the other face it is fully nullified by tensile stress and there is no tension in the cross section. For loading with eccentricity ratio between $\frac{1}{24}$ and $\frac{1}{6}$, we have to limit the maximum stress f_1 to $1.25 f_c$

$$f_1 = \frac{W}{t} \left(1 + \frac{6\bar{e}}{t} \right) = 1.25 f_c$$

∴ Design Load,

$$W = \frac{1.25 f_c t}{1 + \frac{6\bar{e}}{t}}$$

- c) Eccentricity ratio exceeding $\frac{1}{6}$ (see Fig. E-28E)—We had seen from (b) above that when eccentricity ratio reaches the value $\frac{1}{6}$, stress is zero on one face; when this ratio exceeds $\frac{1}{6}$ there will be tension on one face rendering ineffective a part of the section of the masonry and stress distribution in this case would thus be as shown in Fig. E-28E. Average compressive stress:

$$f_a = \frac{f_1 + 0}{2} = \frac{f_1}{2}$$

Since f_1 has to be limited to $1.25 f_c$

$$f_a = \frac{1.25 f_c}{2}$$

The design load W in this case will be equal to average compressive stress multiplied by length ab of the stress triangle abc . Since for equilibrium, the load must pass through the centroid of the stress triangle abc and the load is at a distance of $\frac{t}{2} - \bar{e}$ from the compressive face, we get

$$\frac{ab}{3} = \frac{t}{2} - \bar{e}$$

$$\text{and } ab = 3 \left(\frac{t}{2} - \bar{e} \right)$$

Thus design load, $W = \text{average stress} \times ab$

$$= \frac{1.25 \times f_c}{2} \times 3(t - \bar{e})$$

From the above equation we can see that theoretically design load W is zero when $\bar{e} = t/2$. However from practical considerations \bar{e} should be limited to $t/3$.

- iii) In Appendix C of the Code, use of concrete bed block has been suggested in 3.2 and 3.3. It seems necessary to add that in case some tension is likely to develop in masonry because of eccentricity of concentrated loads, the bed blocks should be suitably reinforced and these should be long enough so as to prevent tensile cracks in masonry due to eccentricity of loading.

5.4.2 Permissible Tensile Stress

In accordance with Note 2 of the clause tensile stress up to 0.1 N/mm^2 and 0.07 N/mm^2 in the masonry of boundary/compound walls is permitted when mortar used in masonry is of M1 and M2 grade respectively or better. This relaxation has been made to effect economy in the

design of the boundry/compound walls since there is not much risk to life and property in the event of failure of such walls.

5.4.3 Permissible Shear Stress

In 1969 version of the Code, provision for Permissible value of shear stress (based on B.S. CP III : Part 2 : 1970²) was 0.15 N/mm^2 (1.5 kg/cm^2) for walls built in mortar not leaner than 1 : 1 : 6 cement : lime : sand mortar. In the 1981 version of the Handbook it had been brought out that experimental research on the subject had proved that when masonry is preloaded, that is, when it is having vertical load, it is capable of resisting greater amount of shear force. Australian Code AS : 1640-1974⁸ had also reflected this already. Based on that in 1980 version of IS 1905, value of Permissible shear stress was suitably modified and was related to amount of preloading, subject to a maximum of 0.5 N/mm^2 and minimum of 0.1 N/mm^2 .

5.4.4 If there is tension in any part of a section of masonry, that part is likely to be cracked and thus cannot be depended upon for resisting any shear force. The clause is based on this consideration. This situation is likely to occur in masonry elements subjected to bending.

5.5 Design Thickness/Cross Section

5.5.1 Walls and Columns Subjected to Vertical Load

5.5.1.1 Solid walls

Brick work is generally finished by either pointing or plastering and with that in view, it is necessary to rake the joints while the mortar is green, in case of plaster work raking is intended to provide key for bending the plaster with the background. Strictly speaking thickness of masonry for purposes of design in these cases is actual thickness less depth of raking. However in case of design of masonry based on permissible tensile stress (as for example design of a free standing wall), if walls are plastered over (plaster of normal thickness i.e. 12 to 15 mm) with mortar of same grade as used in masonry or M2 grade—whichever is stronger or are flush pointed with mortar of M1 grade or stronger, raking may be ignored.

5.5.2 Walls and Columns Mainly Subjected to Lateral Loads

5.5.2.1 Free standing walls

- i) 1980 version of the Code provided for design of a free-standing wall as a gravity structure that is, without placing reliance on the flexural moment of resistance of the wall due to tensile strength of masonry. It was seen that this approach to design resulted in fairly thick walls and maximum height of an unplastered 23 cm thick wall (one-brick thick of conventional size) could be only about 0.86 m while it has been a

common practice since long to build such walls to heights much greater than 0.86 m. It was further seen from Table 9 of 1980 version of the Code (based on BSCP 121 : Part 1 : 1973¹²) that height to thickness ratio of free-standing walls given in relation to certain wind speeds could not be sustained unless flexural moment of resistance of the wall is taken into consideration. From a study of practices being followed in some other countries in this regard, it is evident that, for design of free-standing walls, it is appropriate to take into consideration flexural moment of resistance of masonry according to the grade of mortar used for the masonry.

- ii) Method of working out thickness of free-standing walls by taking advantage of flexural moment of resistance of the wall has been given in Solved Example E-13. It would be seen that self-weight of a free standing wall reduces tensile stress in masonry caused by lateral load that is, wind pressure. Thus heavier the masonry units, lesser is the design thickness of wall for a particular height. It is, therefore, advantageous to build compound walls in stone masonry in place of brick masonry when stone is readily available and thickness has to be greater than one brick. Also it should be kept in view that use of light-weight units such as hollow bricks/blocks in free-standing walls has obvious structural disadvantage.
- iii) As a general rule, a straight compound wall of uniform thickness is not economical except for low heights or in areas of low wind pressure. Therefore, when either height is appreciable or wind pressure is high, economy in the cost of the wall could be achieved by staggering, zig-zagging or by providing diaphragm walls. Instances of design of staggered and diaphragm compound walls are given in Solved Examples E-14 and E-15. It can be seen that for wind pressure of 750 N/m^2 , maximum height of a 23 cm thick brick wall using grade M1 mortar can be 1.5 m for a straight wall, 3.2 m, for a staggered wall and 4.0 m for a diaphragm wall.

5.5.2.2 Retaining walls

This clause is similar to 5.5.2.1 of the Code and method of design of a retaining wall, based on the permissible amount of tension in masonry, is similar to that for a free standing wall.

5.5.3 Walls and Columns Subjected to Vertical as Well as Lateral Loads

- i) Longitudinal walls of tall single storey wide span buildings with trussed roofs such as industrial buildings, godowns, sports halls, gymnasias, etc, which do not have any

intermediate cross walls other than gable walls, tend to be very thick and uneconomical if designed as solid walls, since vertical load is not much and the lateral load due to wind predominates. This would be particularly so when the trusses are not adequately braced at the tie beam level so as to be able to act as horizontal girders for transmitting the lateral loads to the gable walls. In this case, the walls act as simple cantilevers and flexural stress at the base will be quite high. When, however, trusses are adequately braced to provide girder action and are suitably anchored to the gable walls, longitudinal walls would function as propped cantilevers, thus resulting in considerable reduction in bending moments on the long walls as shown in Fig. E-29.

- ii) In UK, masonry diaphragm walls have been adopted in wide-span tall, single storey buildings and these have proved very economical and successful. Principle of a diaphragm wall is similar to that of a rolled steel I-joist that is, placing more material at places where stresses are more.

As a result $\frac{Z}{A}$ ratio of a diaphragm wall is much higher than that of a solid wall, thereby resulting in economy.

- iii) A typical arrangement for laying bricks in a diaphragm wall is shown in Fig. E-30. By varying the depth and spacing of ribs in terms of brick units, designer can obtain an arrangement that meets the requirement in any particular case. Placing of ribs is decided on the consideration that projecting flange length on either side of rib does not exceed 6 times the thickness of the flange. Thus rib-spacing is limited to $12 t_f + t_r$ where t_f and t_r stand for flange and rib thickness respectively. Brick layout in diaphragm wall is planned such that proper masonry bond is obtained with the least number of cut bricks. Designers interested in getting more detailed

information regarding use of diaphragm walls may refer to 'Brick Diaphragm Walls in Tall Single Storey Buildings' by W. G. Curtin and G. Shaw¹³.

5.5.4 Walls Subjected to In-Plane Bending and Vertical Loads (Shear Walls)

A cross wall which functions as a stiffening wall to an external load-bearing wall, is subjected to in-plane bending. If it is also supporting a floor/roof load, it is subjected to vertical load in addition to in-plane bending. The design procedure in this case is given in Example E-11. It should be kept in view that such a wall when subjected to vertical load gets strengthened, since vertical load reduces or nullifies tension due to bending and also increases the value of permissible shear stress (see also comments on 5.4.3).

5.5.5 Non-Load Bearing Walls

- i) Non-load bearing panel and curtain walls, if not designed on the basis of guidelines given in Appendix D of the Code, may be apportioned with the help of Table E-5 which is extracted from Recommended Practices for Engineered Brick Masonry⁴. The table is based on the assumption that wall is simply supported only in one direction either vertically or horizontally without any opening or other interruptions. Where the wall is supported in both directions, the allowable distance between lateral supports may be increased such that the sum of the horizontal and vertical spans between supports does not exceed three times the permissible distance permitted for supporting in the vertical direction.
- ii) Guidelines given in Appendix D of the Code are based on some research in which mainly rectangular panels without openings were tested. If openings are small that is, hole-in-wall type (see E-4.1 Note), there would be no appreciable effect on strength of panels, since timber or metal frames that are built into the openings compensate to a great extent for the loss of

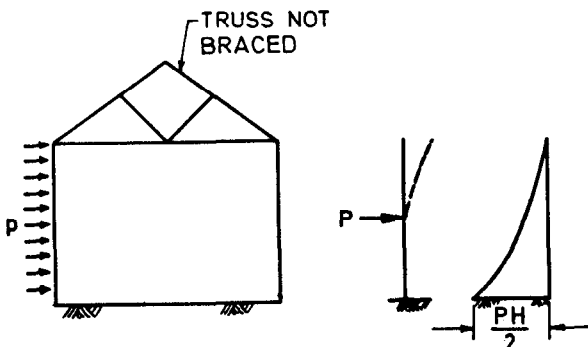

E-29A Trusses Not Braced

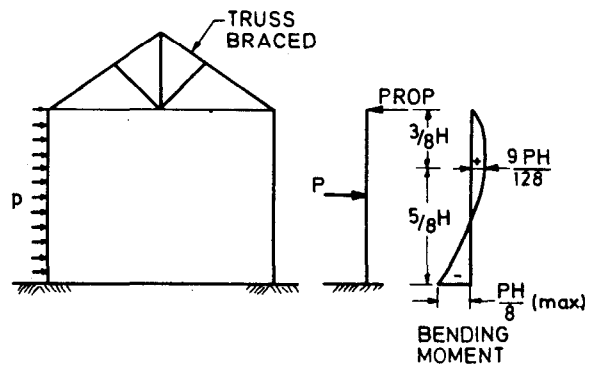

E-29B Trusses Braced

FIG. E-29 EFFECT OF BRACING OF TRUSSED ROOFS ON BUILDINGS

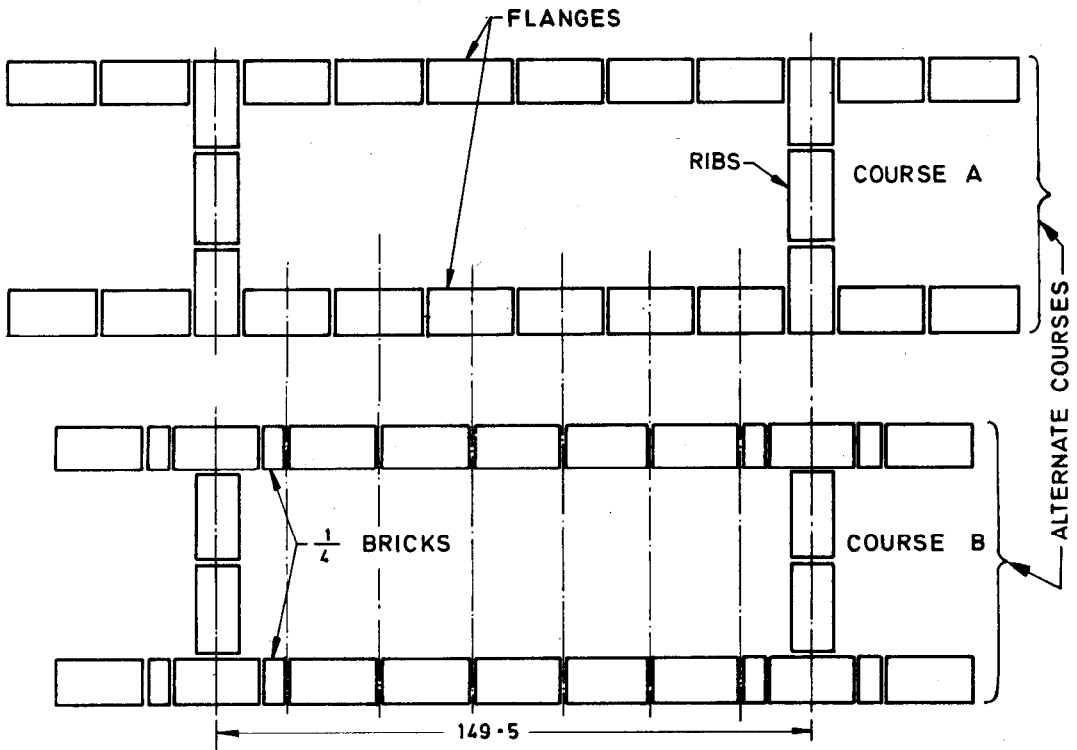

FIG. E-30 TYPICAL BRICK LAYING ARRANGEMENT FOR DIAPHRAGM WALLS

Table E-5 Span to Thickness Ratio of Non-Load Bearing Panel/Curtain Walls

Design Wind Pressure kg/m ²	Vertical Span		Horizontal Span	
	Cement-Lime Mortar 1 : 1 : 6	Cement-Lime Mortar 1 : 1/2 : 4 1/2	Cement-Lime Mortar 1 : 1 : 6	Cement-Lime Mortar 1 : 1/2 : 4 1/2
(1)	(2)	(3)	(4)	(5)
25	38	43	54	61
50	27	30	38	43
75	22	25	31	35
100	19	21	27	30
125	17	19	24	27
150	15	17	22	25

NOTE— Partition walls which are not subjected to any wind pressure that is, internal partition walls may be apportioned with the help of the above Table by assuming a minimum design wind pressure of 250 N/m².

strength of the panel due to the openings. However, when the openings are large or when the openings cannot be categorised as of 'hole-in-wall' type, it may often be possible to design the panel by dividing it into sub-panels as shown in Fig. E-31.

In situations where design by forming sub-panels is not feasible, panel may be analysed using theory of flat plates (for example, yield line theory or finite element method) taking into consideration end conditions as appropriate.

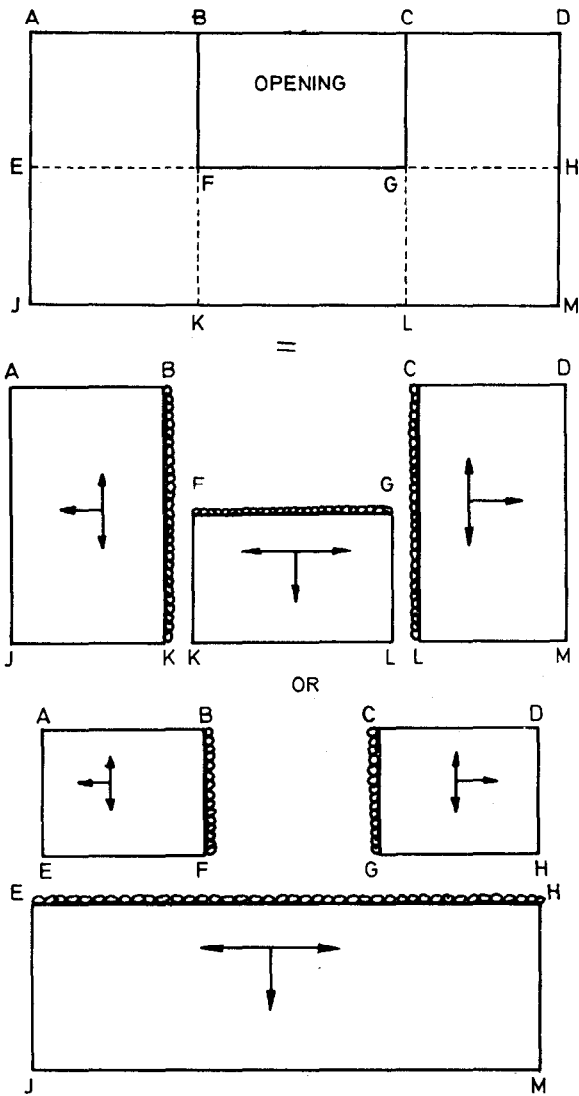

FIG. E-31 DESIGN OF PANEL HAVING A LARGE OPENING

insulation, sound insulation and resistance to rain penetration.

- ii) *Resistance to Fire*—The subject of fire resistance of buildings has been dealt with comprehensively in appropriate Indian Standards¹⁴ and also in Part IV of the National Building Code of India 1983 which may be referred to in this regard.
- iii) *Thermal Insulation*—Thickness of walls in case of non-industrial buildings from consideration of thermal insulation should be worked out for the climatic conditions of the place where a building is to be constructed on the basis of IS 3792 : 1978¹⁵. Even though no Indian Standard has yet been published on the subject for industrial buildings, data and information given in the above Indian Standard would be of some assistance in deciding the thickness of walls from consideration of thermal insulation.

- iv) *Sound Insulation of Value of Wall*
 - a) Indian Standard IS 1950 : 1962¹⁶ lays down sound insulation standards of walls for non-industrial buildings such as dwellings, schools, hospitals and office buildings. Salient features of that standard are summarised below for ready information.
 - b) While deciding thickness/specifications of walls, it is necessary to consider, firstly the level of ambient noise in the locality where building is to be constructed depending upon intensity of traffic and type of occupancy of the building. Noise level of traffic varies from 70 decibels (abbreviated as dB) for light traffic to 90 dB for heavy traffic. Requirements of sound insulation for different buildings from consideration of ambient noise level and occupancy are given in Table E-6. These values are applicable to external walls for reducing out-door air-borne noise.

Table E-6 Requirements of Sound Insulation Values (dB) of External Walls of Buildings Against Air-borne Noise

[Clause 6.2(iv) (b)]

Sl No.	Type of Building	For Noisy Locations (90 dB Level)	For Quiet Locations (70 dB Level)
(1)	(2)	(3)	(4)
1.	Dwellings	45	25
2.	Schools	45	25
3.	Hospitals	50	30
4.	Offices	40	20

6 GENERAL REQUIREMENTS

6.1 Methods of Construction

Information regarding constructional aspects of masonry based on IS Codes (relating to materials of construction, Codes of practice, etc) is given in a classified form in Part 2 of this Handbook for the convenience of the designers, architects and builders.

6.2 Minimum Thickness of Walls From Considerations Other than Structural

- i) Requirements for thickness of walls from considerations other than strength and stability have been discussed below with regard to fire resistance, thermal

c) Sound insulation values of party and internal walls are decided on considerations of levels of indoor noise emanating from adjacent buildings or adjacent rooms and these should be as given in Table E-7.

Table E-7 Sound Insulation Values for Party and Internal Walls

SI No.	Situation	Sound Insulation Values dB
(1)	(2)	(3)
1.	Between living/bed room in one house or flat and living/bed rooms in another	50
2.	Elsewhere between houses or flats	40
3.	Between one room and another in the same house or flat	30
4.	Between teaching rooms in a school	40
5.	Between one room and another in office	30
6.	Between one ward and another in a hospital:	
	Normal	40
	Extra quiet	45

d) Sound insulation values of non-porous homogeneous rigid constructions, such as a well plastered brick/stone masonry or concrete wall, vary as the logarithm of weight per unit area and thus increase with the thickness of wall. These values are given in Table E-8.

Table E-8 Sound Insulation Values of Solid Constructions

Weight Per m ² of Wall Area kg	Sound Insulation Value dB
5	22.8
25	33.2
50	37.6
100	42.0
150	44.7
200	46.4
250	47.9
300	49.1
350	50.0
400	50.9
450	51.6
500	52.3
600	53.6

c) Based on the data given in Table E-8, insulation values of brick walls plastered on both sides work out as in Table E-9.

Table E-9 Sound Insulation Values of Masonry Walls Plastered on Both Sides

Thickness of Wall (cm)	dB
7.7	45.7
10	47.3
11.5	48.0
20	51.3
23	52.2

NOTE—Thickness of walls given above are nominal and exclusive of thickness of plaster.

f) As a general guide, it may be taken that for noise insulation a one-brick wall (20 or 23 cm thick/plastered on both sides as external wall and a 1/2 brick wall (10 or 11.5 cm thick) plastered on both sides as internal walls are adequate.

v) *Resistance to Rain Penetration*—Recommendations for thickness of walls of different types of masonry from consideration of resistance to rain penetration based generally on IS 2212 : 1962¹⁷ are given in Table E-10.

6.3 Workmanship

Common defects of workmanship in masonry are:

- a) Improper mixing of mortar;
- b) Excessive water cement ratio of mortar;
- c) Incorrect adjustment of suction rate of bricks;
- d) Unduly thick bed joints;
- e) Uneven or furrowed bed joints;
- f) Voids in perpend joints; and
- g) Disturbance of bricks after laying.

Improper mixing of mortar and excessive water cement ratio may reduce the strength of mortar to half, thereby affecting the strength of masonry.

Suction rate of bricks has a very pronounced effect on the strength of brick-work and therefore it should be controlled carefully. Water absorbed from mortar by bricks leaves cavities in the mortar, which get filled with air and thereby reduce the strength of mortar. Brick work built with saturated bricks develop poor adherence between brick and mortar. Thus flexural strength as well as shear strength of such brickwork would be low. At the same time such a brickwork will be prone to excessive cracking due to high shrinkage and thus rain-resisting qualities of the brickwork will be poor. British Ceramic Association have suggested a suction rate of 2 kg/min/m², while in accordance with Canadian Code³ and American

**Table E-10 Suitability of Walls for Different Exposures
(R—Recommended and NR—Not Recommended)**

Sl No.	Particulars of Wall	Type of Exposure		
		Sheltered	Moderate	Severe
(1)	(2)	(3)	(4)	(5)
1.	Brick masonry—burnt clay or sand-lime			
	a) 1 brick wall—not plastered	R	NR	NR
	b) 1 brick wall—plastered both sides	R	R	NR
	c) 1½ brick wall—not plastered	R	R	NR
	d) 1½ brick wall—plastered both sides	R	R	R
2.	Stone masonry			
	a) Minimum thickness 35 cm—not plastered	R	R	NR
	b) Minimum thickness 35 cm—plastered both sides	R	R	R
3.	Concrete block masonry 20 cm minimum thickness			
	a) Not plastered	R	NR	NR
	b) Plastered on both sides	R	R	NR
4.	Stone blocks—20 cm, <i>Min</i> thickness			
	a) Not plastered	R	NR	NR
	b) Plastered both sides	R	R	NR
5.	Cavity wall of 25 cm, <i>Min</i> thickness	R	R	R

NOTES

1 Use of cement-lime or lime mortar in place of cement mortar appreciably improves the resistance of a wall to rain. It is also important that joints in masonry are fully filled with mortar.

2 Sheltered conditions are those where wall is protected by overhangs or adjoining buildings or rainfall is low (less than 750 mm per year and is generally not accompanied by strong winds. 'Severe conditions' occur when wall is subjected to strong winds and persistent rain and there is no sheltering action of overhangs or adjoining buildings, or rain fall is heavy (exceeding 1 000 mm). 'Moderate condition' obtains when exposure conditions are between 'Sheltered' and 'Severe' conditions.

Practice⁶ adjustment in suction rate is required, if initial absorption rate exceeds 1 kg/min/m².

The Commentary on Australian Code⁸ specifies that suction of bricks should be between 1.0 to 3.0 kg/min/m². Optimum suction rate depends on atmospheric conditions, namely, temperature and humidity as well as certain properties of mortar used in masonry. It is desirable that suitable provision for suction rate should be made in our Code after obtaining sufficient data from experimental studies.

Strength of masonry gets reduced as the thickness of bed joints increases. Taking normal thickness of bed joints as 10 mm, an increase of 3 mm in thickness of bed joints may reduce the strength of brick masonry by 15 percent and *vice versa*.

Experiments conducted in other countries indicate that uneven or furrowed joints can reduce strength of brickwork up to about 33 percent. Thus, this is rather a serious defect in masonry construction.

Inadequately filled vertical joints, substantially lower the rain resisting property of walls. Disturbance of bricks after laying affect the bond strength as well as shear strength of brickwork and therefore should be avoided. If adjustment in

position of bricks after laying becomes necessary bricks as well as mortar should be completely removed and brickwork redone with fresh mortar.

NOTE—Some masons have the habit of making a furrow in the mortar of the bed joint in the middle parallel to the face, before laying a course of bricks, so as to lessen squeezing out of mortar from the bed joints on pressing into position.

This practice should be avoided.

6.4 Joints to Control Deformation and Cracking

BIS has published a Handbook on 'Causes and Prevention of Cracks in Buildings'¹⁷. This book would be of considerable help to designers, architects, engineers and builders for controlling and prevention of cracks in masonry.

6.6 Corbelling

i) Limitations of a corbel have been illustrated in Fig. E-32. With these limitations, minimum slope of corbelling (angle measured from the horizontal to the face of the corbelled surface) would work out to 63°, when using modular bricks with header courses in the corbelled portion.

ii) Load on a corbel has very high eccentricity. It is, therefore, necessary to exercise great

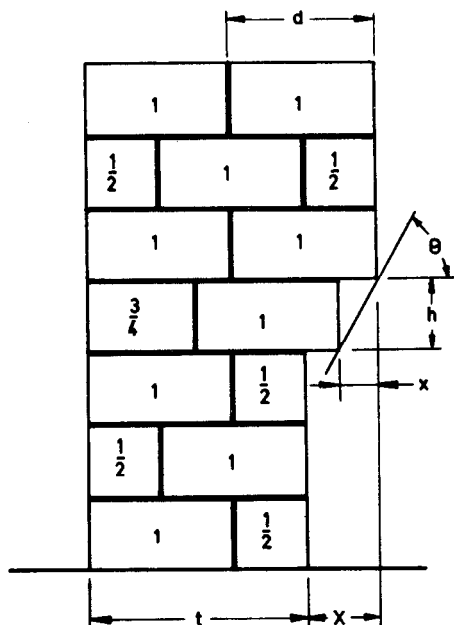

$$x \leq \frac{h}{2} \quad x \leq \frac{t}{3}$$

$$x \leq \frac{d}{3} \quad \omega = \tan^{-h/x}$$

- x = allowable projection of one unit.
- X = total allowable horizontal projection of corbel.
- t = nominal wall thickness (actual-plus thickness thickness of one joint)
- h = nominal unit height (actual height plus thickness of one joint).
- d = nominal bed depth of unit (actual bed depth of unit plus thickness of joint).
- θ = slope of corbel (angle measured from the horizontal to the face of the corbelled surface).

FIG. E-32 LIMITATION OF A CORBEL IN MASONRY

caution in the use of corbelling in buildings since eccentricity in loads appreciably reduces the permissible compressive stress in masonry. As it is not feasible to make

precise calculations of actual stress in the corbelled portion of masonry, the Code provides for some empirical rules to limit the stress to within safe limits.

ANNEX H-1

WORKED EXAMPLES ON DESIGN OF STRUCTURAL MASONRY

(In the solved examples which follow, numerical values have been liberally rounded off with a view to simplifying calculation work. Also, since calculations relating to masonry cannot be very precise, approximations in computation have been made when such approximations are not likely to affect the end results. Emphasis in the solutions is more on practical results than on arithmetical accuracy.)

Example 1 : Effective Height, Effective Length, Effective Thickness and Slenderness Ratio of Walls and Columns

In a double storeyed building walls are 20 cm thick; clear height of floors is 3.0 m; plinth is 0.7 m above the foundation footing, floor and roof are of RCC 12 cm thick, door height is 2.1 m, window height is 1.5 m and plan of the building is as shown in Fig. E-33. Work out effective height, effective length, effective thickness and slenderness ratio of walls and columns of First and Second floors.

Solution

1. Effective Height

a) First floor

$$\begin{aligned} \text{Actual height } H &= 0.7 + 3.0 + 0.06 \\ &= 3.76 \text{ m} \end{aligned}$$

A, B, C, D, E, J and *M* are all walls, having length more than 4 times thickness and thus:

$$\begin{aligned} \text{Effective height,} \\ h &= 0.75 H \\ &= 0.75 \times 3.76 \\ &= 2.82 \text{ m} \end{aligned}$$

In case of *F, K* and *N* wall, even though length is less than 4 t , these are not to be treated as columns, because they are supported on one side by cross walls. Their effective height, therefore, will be

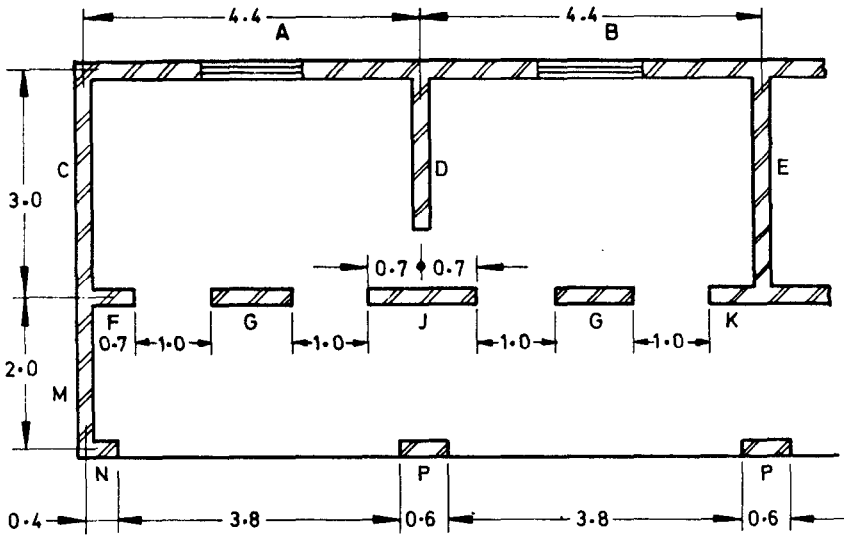

All dimensions in metres.

FIG. E-33

determined as in the case of wall and will be 2.82 m.

Brickwork G—Since length is less than $4t$, it is a column by definition; thus as per 4.3.3:

$$\begin{aligned} h &= 0.75 H + 0.25 H_1 \\ &= 0.75 \times 3.76 + 0.25 \times 2.1 \\ &= 3.34 \text{ m} \end{aligned}$$

Brickwork P is a column being less than $4t$ in length, and is supported in both the horizontal directions by RCC beam/slab.

Effective height is thus:

$$\begin{aligned} h &= H \\ &= 3.76 \text{ m in both directions.} \end{aligned}$$

b) *Second floor*

$$\begin{aligned} H &= 0.06 + 3.0 + 0.06 \\ &= 3.12 \text{ m} \end{aligned}$$

$$\begin{aligned} h \text{ for } A, B, C, D, E, F, J, K, M \text{ and } N &= 0.75 H \\ &= 0.75 \times 3.12 \\ &= 2.34 \text{ m} \end{aligned}$$

$$\begin{aligned} h \text{ for } G &= 0.75 \times 3.12 + 0.25 \times 2.1 \\ &= 2.87 \text{ m} \end{aligned}$$

$$\begin{aligned} h \text{ for } P \text{ in both directions} &= H \\ &= 3.12 \text{ m} \end{aligned}$$

2. *Effective Length of Walls*

Effective length of walls will be same in first floor and second floor.

Wall A—It is continuous on one end and discontinuous on the other end is supported by cross walls.

$$\begin{aligned} \therefore l &= 0.9 L \\ &= 0.9 \times 4.4 \\ &= 3.96 \text{ m} \end{aligned}$$

Wall B—It is continuous on both ends and is supported by cross walls.

$$\begin{aligned} \therefore l &= 0.8 L \\ &= 0.8 \times 4.4 \\ &= 3.52 \text{ m} \end{aligned}$$

Wall C—It is discontinuous on one side and continuous on the other and is supported by cross walls on both sides.

$$\begin{aligned} \therefore l &= 0.9 L \\ &= 0.9 \times 3.0 \\ &= 2.7 \text{ m} \end{aligned}$$

Wall D—It is discontinuous on one side and has an opening on the other side which is taller than $0.5 H$.

$$\begin{aligned} \therefore l &= 1.5 \times 3.0 \\ &= 4.5 \text{ m} \end{aligned}$$

Wall E—This wall is discontinuous in both sides, but is braced by cross walls.

$$\begin{aligned} \therefore l &= L \\ &= 3.0 \text{ m} \end{aligned}$$

Brickwork F—This wall, because of opening taller than $0.5 H$ is free on one end and is

supported by cross wall on the other end is discontinuous.

$$\begin{aligned} \therefore l &= 2L \\ &= 2 \times 0.7 \\ &= 1.4 \text{ m} \end{aligned}$$

Brickwork G—It has no support on either side and thus slenderness for this element will be governed by its height.

Brickwork J—Same as brickwork G.

Brickwork K—This is free at one end and supported by a cross wall but continuous at the other.

$$\begin{aligned} \therefore l &= 1.5L \\ &= 1.5 \times 0.7 \\ &= 1.05 \text{ m} \end{aligned}$$

NOTE—The element K has been taken as continuous on one end, because length of wall between cross wall and opening is more than

$$\begin{aligned} \frac{H}{8} &= \frac{3}{8} \\ &= 0.37 \text{ m} \end{aligned}$$

Wall M—The wall is continuous on one side and discontinuous on the other. On one side it is supported by a cross wall which is more than

$$\frac{H}{5} = \frac{3}{5} = 0.60 \text{ m}$$

in length, being $0.70 - 0.095 = 0.605 \text{ m}$.

On the other side, length of cross wall is less than $H/5$ and thus this side is not adequately supported. The brickwork is thus supported and continuous on one side and free on the other, thus

$$\begin{aligned} l &= 1.5L \\ &= 1.5 \times 2 \\ &= 3.0 \text{ m} \end{aligned}$$

Brickwork N—This element is discontinuous and supported on one end and free at the other, thus

$$\begin{aligned} l &= 2L \\ &= 2 \times 0.40 \\ &= 0.80 \text{ m} \end{aligned}$$

Column P : Same as G.

3. Effective Thickness

Assume joints are not raked. Actual thickness will therefore be 19 cm. From examination of the plan we find that walls A, B, C, E and M are stiffened by cross walls. Thus effective thickness will be actual thickness multiplied by Stiffening coefficient. In all other cases, effective thickness will be same as actual thickness. Stiffening coefficient of the walls A, B, C, E and M in accordance with Table 3 of the Code will be as

follows:

Walls A and B :

$$\frac{t_p}{t_w} = 3$$

$$\frac{S_p}{W_p} = \frac{4.4}{0.19}$$

$$= 23$$

This being more than 20, Stiffening Co-efficient

$$k_n = 1$$

Walls C and E:

$$\frac{t_p}{t_w} = 3$$

$$\frac{S_p}{W_p} = \frac{3.0}{0.19}$$

$$= 15 \text{ approximately}$$

$$k_n = 1.2$$

Wall M:

$$\frac{t_p}{t_w} = \frac{0.40 + 0.095}{0.19}$$

$$= 2.6 \text{ say } 2.5$$

$$\frac{S_p}{W_p} = \frac{2.0}{0.19}$$

$$= 10.5 = 10 \text{ (say)}$$

$$k_n = \frac{1.2 + 1.4}{2}$$

$$= 1.3 \text{ (By interpolation)}$$

4. Slenderness Ratio

We may tabulate values of effective height, effective length, effective thickness, and stiffening co-efficient for each element of brickwork worked out earlier and then calculate values of slenderness ratio as in Table E-11.

Example 2 : Working out Resultant Eccentricity

A masonry wall, 20 cm thick (see Fig. E-34) carries an axial load 27 kN/m from wall above and an eccentric load 16 kN/m from RCC floor acting at a distance 4.75 cm from the centre line of the wall. Determine the resultant eccentricity of loading and eccentricity ratio.

Solution

Let W be the total vertical load and e the Resultant eccentricity of all loads.

Taking moments about the centre line of wall

$$W\bar{e} = W_1 \times 0 + W_2 \times 4.75$$

$$(27 + 16) \times 10^3 \bar{e} = 27 \times 10^3 \times 0 + 16 \times 10^3 \times 4.75$$

$$\bar{e} = \frac{16 \times 10^3 \times 4.75}{43 \times 10^3}$$

$$= 1.77 \text{ cm}$$

Table E-11 Values of Slenderness Ratio

Brickwork Element	First Floor, $t = 0.19$				Second Floor, $t = 0.19$				Remarks
	h	l	k_n	SR	h	l	k_n	SR	
(1)	(2)	(3)	(4)	(5)	(6)	(7)	(8)	(9)	(10)
A	2.82	3.96	1.0	14.8	2.34	3.96	1	12.3	Value of SR shown in the table is the one that is to be taken into consideration for design
B	2.82	3.52	1	14.8	2.34	3.52	1	12.3	
C	2.82	2.7	1.2	12.4	2.34	2.7	1.2	10.3	
D	2.82	4.5	1	14.8	2.34	2.7	1	12.3	
E	2.82	3.0	1.2	12.4	2.34	3.0	1.2	10.3	
F	2.82	1.4	1	7.4	2.34	1.4	1	7.4	
G	3.34	—	1	17.6	2.87	—	1	15.1	
J	2.82	—	1	14.8	2.34	—	1	12.3	
K	2.82	1.05	1	5.5	2.34	1.05	1	5.5	
M	2.82	3.0	1.3	11.4	2.34	3.0	1.3	0.5	
N	2.82	0.80	1	4.2	2.34	0.80	1	4.2	
P	3.76	—	1	19.8	3.12	—	1	16.4	

NOTES

1 In case of walls $SR = \frac{h}{t \times k_n}$ or $\frac{l}{t}$ and for design lesser of the two values is considered.

2 In case of columns if SR is different for the two horizontal axes, greater of the two values of SR is considered in design.

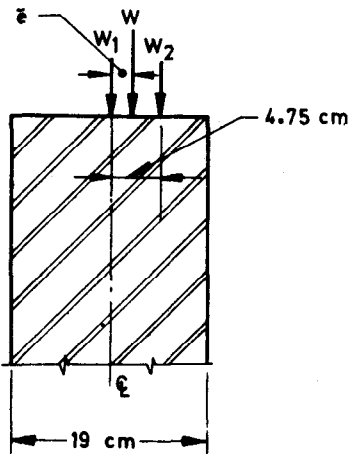

$$W_1 = 27 \text{ kN/m}$$

$$W_2 = 16 \text{ kN/m}$$

$$W = W_1 + W_2 = 43 \text{ kN/m}$$

FIG. E-34

Resultant eccentricity ratio,

$$\frac{\bar{e}}{t} = \frac{1.77}{19} = 0.09$$

Example 3 : Design of a Wall Carrying Axial Load

A load bearing brick masonry wall of a building is 20 cm thick, is laterally supported by RCC slabs at top and bottom, which are 12 cm thick each

and clear height between slabs is 3.0 m. If the wall has an axial load of 71.5 kN/m at the base, inclusive of self-weight, what should be the crushing strength of bricks and grade of mortar for the wall. Wall is 4 m long between cross walls and bricks used are of modular size. Assume that there are no openings in the wall within $\frac{H}{8}$ of its junction with cross walls and there are no openings in cross walls within $\frac{H}{5}$ of their junctions with the load bearing wall under consideration. Assume that two ends of wall are discontinuous and joints are not raked.

Solution

Effective height,

$$h = 0.75 H$$

$$= 0.75 (3 + 0.12)$$

$$= 2.34 \text{ m}$$

$$t = 19 \text{ cm}$$

$$SR = \frac{h}{t}$$

$$= \frac{2.34}{0.19}$$

$$= 12.3$$

NOTE—Since cross walls are more than $0.19 \times 20 = 3.80 \text{ m}$ apart, value of stiffening co-efficient as per Table 6 of the code will be equal to one.

Effective length,

$$l = L \\ = 4.0 \text{ m}$$

(Case at Sl. No. 3 of Table 5 of the Code)

Since effective height is less than effective length, SR based on height will control the design.

Stress reduction factor k_s with zero eccentricity (from Table 9 of the Code for SR 12.3, by interpolation)

$$= 0.84 - \frac{(0.84 - 0.78) \times 0.3}{2} \\ = 0.84 - 0.01 \\ = 0.83$$

Compressive stress in masonry

$$= \frac{71.5 \times 10^3}{19 \times 100} = 37.6 \text{ kg/cm}^2 = 0.376 \text{ N/mm}^2$$

With Shape modification factor = 1, Basic Compressive stress of masonry

$$= \frac{0.376}{0.83} \\ = 0.45 \text{ N/mm}^2$$

Referring to Table 8 of Code we find that bricks of strength 5.0 N/mm² are required if the bricks have height to width ratio equal to 0.75. Since modular bricks are used which have height to width ratio of 1.0, value of Shape modification factor (from Table 10 of the Code) equals to 1.2.

Thus Basic Compressive stress required

$$= \frac{0.45}{1.2} \\ = 0.38 \text{ N/mm}^2$$

Referring to Table 8 of the Code again, masonry required is—bricks of 5 N/mm² strength and mortar of M3 grade.

Example 4 : Design of an Axially Loaded Short Length Wall of a Double Storeyed Building

If masonry element P in first floor of Example 1 carries a load of 44 kN at the base inclusive of self load, what should be the strength of bricks and grade of mortar for masonry in question? Assume that joints are not raked.

Solution

Length of masonry element as per plan

$$= 0.6 \text{ m}$$

As length is less than 4 times its thickness, the element by definition is a column. SR for this column, as worked out in Example 1 is 19.8. Area of P in plan = $0.19 \times 0.6 = 0.114 \text{ m}^2$. The area being less than 0.2 m^2 (see 5.4.1.2 of the Code). Area Reduction factor (k_a) will be applicable and

this will be:

$$k_a = 0.70 + 1.5A \\ = 0.70 + 1.5 \times 0.114 \\ = 0.87$$

Stress reduction factor for zero eccentricity and SR : 19.8 from Table 9 of Code by interpolation is

$$= 0.67 - \frac{(0.67 - 0.62) \times 0.2}{2} \\ = 0.665$$

Compressive stress in masonry

$$= \frac{W}{A} = \frac{44 \times 10^3}{0.114 \times 10^4} \\ = 38.6 \text{ N/cm}^2 \\ = 0.386 \text{ N/mm}^2$$

For Shape modification factor equal to 1, Basic compressive stress of masonry in question is to be

$$= \frac{0.386}{0.665 \times 0.87} \\ = 0.67 \text{ N/mm}^2$$

From Table 8 of the Code it is seen that strength of bricks in this case should be 7.5 N/mm².

Height to breadth ratio of modular bricks

$$= \frac{0.9}{0.9} = 1$$

Thus from Table 10, $k_p = 1.1$ and value of Basis Compressive stress should thus be

$$\frac{0.67}{1.1} = 0.6 \text{ N/mm}^2$$

and grade of mortar for this Basis Compressive stress (vide Table 8) should be M1 and masonry in question for element P would thus be : 7.5 – M1.

Example 5 : Design of a Wall Carrying Eccentric Load, Eccentricity Ratio Being Less than $\frac{1}{24}$

If load at the top of wall in case of Example 4 is acting at a distance of 0.7 cm from the centre line of the wall, design the brick masonry for the wall.

Solution :

$$\text{Eccentricity ratio} = \frac{e}{t} \\ = \frac{0.7}{19} \\ = 0.037$$

Since this is less than $\frac{1}{24}$ it is not necessary to

work out bending stress on account of eccentricity as per Note below of 5.4.1 of the Code. Thus axial stress in masonry at the base will govern the

design and masonry required will be as worked out earlier in Example 4, namely 7.5-M1.

Example 6 : Design of a Wall with Eccentric Load, Eccentricity Ratio Being Between $\frac{1}{24}$ and $\frac{1}{6}$

A wall 20 cm thick, using modular bricks carries at the top a load of 80 kN/m having resultant eccentricity ratio of $\frac{1}{12}$. Wall is 5 m long between cross walls and is of 3.4 m clear height between RCC slabs at top and bottom. What should be the strength of brick and grade of mortar. Assume that joints are not raked.

Solution :

As effective height of the wall is less than its length, SR in the direction of height will govern the design. Also since length to thickness ratio of the wall exceeds 20, stiffening coefficient of wall will be unity. Moreover, element being fairly long, Area reduction factor will not apply.

$$\begin{aligned} \text{Actual thickness} &= 20 - 1 \\ &= 19 \text{ cm} \\ \text{SR} &= \frac{0.75 \times 3.4}{0.19} \\ &= 13.4 \end{aligned}$$

Although theoretically as explained in E-4.7 critical stress in masonry in any storey occurs at a height of 0.6 *H* from the bottom support, we would for the sake of simplicity in calculations, assume it to occur at bottom support.

Axial stress in masonry due to loading at top

$$\begin{aligned} &= \frac{W}{A} \\ &= \frac{80 \times 10^3}{100 \times 19} \\ &= 42 \text{ N/cm}^2 = 0.42 \text{ N/mm}^2 \end{aligned}$$

Axial stress due to self load of wall at bottom support (*W* being the unit weight of masonry)

$$\begin{aligned} &= \frac{WAH}{A} \\ &= \frac{20 \times 10^3 \times 3.4}{10^6} \\ &= 0.068 \text{ N/mm}^2 \end{aligned}$$

Bending stress due to eccentricity of load at the top.

$$\begin{aligned} &= \frac{M}{Z} = \frac{W\bar{x} \times 6}{bd^2} \\ &= \frac{80 \times 10^3 \times 20 \times 6}{100 \times 19^2 \times 12} \end{aligned}$$

$$\begin{aligned} &= 22 \text{ N/cm}^2 \\ &= 0.22 \text{ N/mm}^2 \end{aligned}$$

Thus maximum compressive stress fl in masonry on one face = axial stress + bending stress

$$\begin{aligned} &0.42 + 0.068 + 0.22 \text{ N/mm}^2 \\ &0.708 = 0.71 \text{ say} \end{aligned}$$

Stress reduction factor *k_s* for SR = 13.4 and eccentricity ratio $\frac{1}{12}$ (from Table 9 of the Code, by interpolation)

$$\begin{aligned} &= 0.81 - (0.81 - 0.74) \times \frac{1.4}{2} \\ &= 0.76 \end{aligned}$$

In accordance with 5.4.1.4(a) of the Code 25 percent additional stress is allowed for eccentricity ratio between $\frac{1}{24}$ and $\frac{1}{6}$.

Therefore Basic compressive stress of required masonry having Unity Shape modification factor should be

$$\begin{aligned} &= \frac{0.71}{0.76 \times 1.25} \\ &= 0.74 \text{ N/mm}^2 \end{aligned}$$

From Table 8 of the Code we find that bricks should have strength of 7.5 N/mm². Since modular bricks are being used, which have width to height ratio of 1, Shape modification factor *k_s* from Table 10 of the Code is 1.1 and thus masonry should have Basic Compressive stress

$$\begin{aligned} &= \frac{0.74}{1.1} \\ &= 0.67 \end{aligned}$$

Referring to Table 8 of the Code again we find that, using bricks of 7.5 N/mm² strength, grade of mortar should be M1. This masonry is designated as : 7.5-M1.

NOTE—It is a normal practice to work out stress on masonry just above the bottom support for every storey of a building and to design the masonry for slenderness of wall along with resultant eccentricity of loading at the top support.

Example 7 : Design of a Wall Eccentric Load, Eccentricity Ratio Being Greater Than $\frac{1}{6}$

A 23 cm thick brick masonry wall (see Fig. E-35) carries an axial load of 12 kN per meter length and eccentric load of 27 kN per meter length acting at a distance of 7.33 cm from the axis of the wall. Design the masonry for the wall if its Slenderness ratio is 16, assume that joints are not raked.

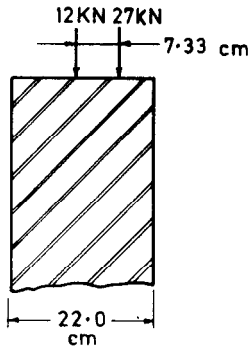

FIG. E-35

Solution

Resultant eccentricity, e

$$\begin{aligned}
 &= \frac{W_1 \times e_1 + W_2 \times e_2}{W_1 + W_2} \\
 &= \frac{12 \times 10^3 \times 0 + 27 \times 10^3 \times 7.33}{(12 + 27) \times 10^3} \\
 &= 5.07 \text{ cm}
 \end{aligned}$$

$$\begin{aligned}
 \text{Eccentricity ratio} &= \frac{\bar{e}}{t} \\
 &= \frac{5.07}{23 - 1} \\
 &= 0.23
 \end{aligned}$$

This being more than $\frac{1}{6}$, there will be tension on one face and effective thickness of wall supporting the load will get reduced. Referring to E-5.4.1.4(ii)(c), thickness of wall in compression

$$\begin{aligned}
 &= 3 \left(\frac{t}{2} - \bar{e} \right) \\
 &= 3 \left(\frac{23}{2} - 5.0 \right) \\
 &= 17.8 \text{ cm}
 \end{aligned}$$

Maximum Compression stress in masonry would be twice the average compressive stress on the area under compression since stress distribution is triangular. Thus maximum compressive stress

$$\begin{aligned}
 &= \frac{2 \times (12 + 27) 10^3}{100 \times 17.8} \\
 &= 44 \text{ N/cm}^2 \\
 &= 0.44 \text{ N/mm}^2
 \end{aligned}$$

Stress reduction factor k_s for SR 16 and eccentricity ratio 0.23 (from Table 9 of the Code, by interpolation)

$$\begin{aligned}
 &= 0.63 - (0.63 - 0.58) \\
 &\quad \frac{(0.23 - 0.16)}{(0.25 - 0.16)} \\
 &= 0.59
 \end{aligned}$$

Since 25 percent higher stress is permissible as per 5.4.1.4(b) of the Code, and Shape modification factor k_p of bricks is unity because bricks have height to width ratio less than 0.75, Basic compressive stress of required masonry

$$\begin{aligned}
 &= \frac{0.44}{0.59 \times 1.25} \\
 &= 0.6 \text{ N/mm}^2
 \end{aligned}$$

Thus from Table 8 of the Code strength of brick should be 7.5 N/mm^2 and grade of mortar M1. Marginally even mortar M2 can do.

Example 8 : Design of a Wall with Openings

External wall of a single storeyed house is 20 cm thick, and has door and window openings as shown in Fig. E-36. Plinth level is 1.20 m above the top of foundation footing and floor to ceiling height is 2.80 m. One way RCC slab of 3 m clear span bears on the wall and is 10 cm thick. Determine the maximum stress in the wall and calculate strength of bricks and grade of mortar required for the wall. There is a 20 cm thick parapet wall of 0.8 m height above the roof slab. Wall and parapet are plastered on both sides.

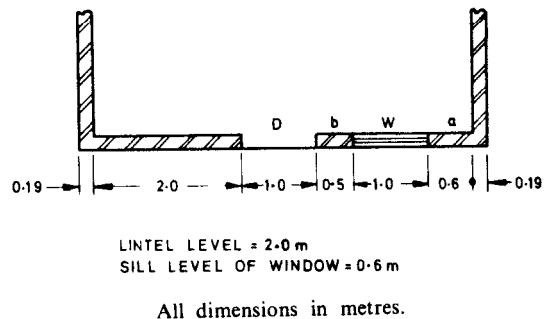

FIG. E-36

Solution

From a visual examination of Fig. E-36 it is observed that portion 'b' of wall will have the maximum stress. We will, however, for the sake of comparison and illustration, work out stress at plinth level in portion 'a' of the wall as well. Since there are no openings below PL, load disperses below plinth and corresponding stresses get reduced notwithstanding the increase in self-load of masonry.

Loads

$$\begin{aligned}
 \text{Parapet} &= \frac{(19 + 3)}{100} \times 0.80 \times 20 \times 10^3 \\
 &= 3.52 \text{ kN/m}
 \end{aligned}$$

Roof Load

$$\begin{aligned} \text{RCC slab 10 cm thick} \\ &= 10 \times 250 \\ &= 2500 \text{ N/m}^2 = 2.5 \text{ kN/m}^2 \end{aligned}$$

$$\begin{aligned} \text{Lime concrete terrace 12 cm thick} \\ &= 12 \times 200 \\ &= 2400 \text{ N/m}^2 = 2.4 \text{ kN/m}^2 \end{aligned}$$

$$\text{Live load} = 1.5 \text{ kN/m}^2$$

$$\text{Total load} = 6.4 \text{ kN/m}^2$$

$$\begin{aligned} \text{Clear span of slab} \\ &= 3.00 \text{ m} \end{aligned}$$

$$\begin{aligned} \text{Effective span} \\ &= 3.00 + 0.10 \\ &= 3.10 \text{ m} \end{aligned}$$

$$\begin{aligned} \therefore \text{Roof load on wall} \\ &= \frac{6.4 \times 3.1}{2} \\ &= 9.92 \text{ kN/m} \end{aligned}$$

$$\begin{aligned} \text{Thickness of wall including plaster} \\ &= 19 + 3 \\ &= 22 \text{ cm} \end{aligned}$$

$$\begin{aligned} \text{Self-load of wall up to plinth level} \\ &= \frac{22}{100} \times 2.8 \times 20 \times 10^3 \\ &= 12.32 \times 10^3 \text{ N/m} \\ &= 12.32 \text{ kN/m} \end{aligned}$$

It is a common practice not to make any deduction in wall loads on account of openings, since calculations for design of masonry are not very precise.

Portion 'a' of wall

$$\text{Length} = 0.60 + \frac{0.19}{2}$$

(Length of wall 'a' has been taken up to centre of cross wall)

$$= 0.69 \text{ m}$$

This portion bears additional load on account of opening on one side, which is 1.0 m in width.

$$\begin{aligned} \therefore \text{Total load on wall} \\ &= (3.52 + 9.92 + 12.32) \\ &\quad \times \left(0.69 + \frac{1.0}{2}\right) \\ &= 25.76 \times 1.39 \\ &= 30.65 \text{ kN} \end{aligned}$$

Since wall is plastered on both sides, it may be assumed to have raked joints on both sides.

$$\begin{aligned} \text{Thus effective thickness} \\ &= 19 - 2 \\ &= 17 \text{ cm} \end{aligned}$$

Compressive stress at plinth level

$$\begin{aligned} &= \frac{W}{A} \\ &= \frac{30.65 \times 10^3}{17 \times 69} \\ &= 26 \text{ N/cm}^2 = 0.26 \text{ N/mm}^2 \end{aligned}$$

Slenderness ratio from consideration of height

$$\begin{aligned} &= \frac{h}{t} \\ &= 0.75 \times \frac{(1.20 + 2.80 + 0.05)}{0.17} \\ &= 18 \end{aligned}$$

Though length of wall 'a' is less than 4 t that is, 76 cm, it will not be considered as a column, because it is supported by a cross wall on one side.

Effective length l

$$\begin{aligned} &= 2 L \\ &= 2 \times 0.69 \\ &= 1.38 \text{ m (see Table 5 of the Code)} \end{aligned}$$

Therefore SR in the direction of length

$$\begin{aligned} &= \frac{1.38}{0.17} \\ &= 8.0 \end{aligned}$$

Since lengthwise SR is less than that in the direction of height, former will govern the design.

Stress reduction factor k_s for SR 8.0 (from Table 9 of the Code)

$$= 0.95$$

Area reduction factor k_a (see 5.4.1.2)

$$\begin{aligned} \text{where} \\ A &= 0.17 \times 0.69 \end{aligned}$$

$$\begin{aligned} \therefore k_s &= 0.117 \text{ m}^2 \\ &= 0.70 + 1.5 \times 0.117 \\ &= 0.70 + 0.18 \\ &= 0.88 \end{aligned}$$

Therefore, basic compressive stress of required masonry, with unity Shape modification factor

$$= \frac{0.26}{0.93 \times 0.8B}$$

$$= 0.31 \text{ N/mm}^2$$

Portion 'b' of wall

$$\text{Length} = 0.5 \text{ m.}$$

This being less than 4 t , by definition it becomes a column.

This portion of wall has openings on both sides, therefore, total weight on wall at plinth level

$$= 25.76 \left(\frac{1.0}{2} + 0.50 + \frac{1.0}{2} \right)$$

$$= 38.64 \text{ kN}$$

Compressive stress in wall at plinth level

$$= \frac{38.64 \times 10^3}{17 \times 50} = 45 \text{ N/cm}^2$$

$$= 0.45 \text{ N/mm}^2$$

Slenderness Ratio

Effective height for the masonry for the direction perpendicular to the plane of the wall (see 4.3.3)

$$h = 0.75H + 0.25 H_1$$

Where H_1 is the height of taller opening

$$= 0.75(1.2 + 2.8 + 0.05)$$

$$+ 0.25 \times 2.0$$

$$= 3.04 + 0.50$$

$$= 3.54 \text{ m}$$

Effective height of masonry for the direction parallel to the Wall

$$h = H$$

$$= 1.2 + 2.8 + 0.05$$

$$= 4.05 \text{ m}$$

SR for the two axes of wall will be

$$= \frac{3.54}{0.17} = 2.1 \text{ and } \frac{4.05}{0.5} = 8.1$$

Thus SR 21 will govern the design as element is being deemed to be a column

$$k_s \text{ from Table 9 of the Code for SR 21}$$

$$= 0.59$$

Area of the portion of wall in plan

$$= 0.5 \times 0.17$$

$$= 0.085 \text{ m}^2$$

Since plan area is less than 0.2 m^2 , Area reduction factor (see 5.4.1.2) will apply.

$$\text{Area reduction factor } k_a$$

$$= 0.7 + 1.5 A$$

$$= 0.7 + 1.5 \times 0.085$$

$$= 0.83$$

Thus Basic compressive stress of requisite masonry with unity Shape modification factor

$$= \frac{f_a}{k_s \times k_a}$$

$$= \frac{0.45}{0.59 \times 0.83}$$

$$= 0.92 \text{ N/mm}^2$$

Obviously stress in Wall 'b' will govern the design. Referring to Table 8 of the Code, we see that bricks of 10.0 N/mm^2 strength are required. For these bricks from Table 10 of the Code, $k_p = 1.1$ and thus Basic compressive stress of required masonry should be

$$= \frac{0.92}{1.1} = 0.84 \text{ N/mm}^2$$

Thus from Table 8 we get grade of mortar for the masonry to be M1. It may be mentioned that if there is only a small portion of wall which is carrying high stress, it may be possible to effect economy in cost by using a lower grade masonry for walls which do not have large openings and to use the masonry we have calculated only for the portions of wall 'b', which has openings in both sides. For that purpose stresses on other walls should also be calculated and masonry designed accordingly. It should however be kept in view that if in one storey of a building, bricks and mortar of different strength/grades are to be used a very close supervision is required in order to avoid mistakes.

Example 9 : Design of a Wall with Concentrated Loads from Beams

Wall of a single storey building as shown in Fig. E-37 carries a concentrated load of 70 kN from a beam. Design the wall as well as bed block under the beam. Roof of the building consists of an RCC slab which bears on cross walls and beams. Height to width ratio of the building is less than 2 and span of the beam is 6 meters. RCC slab is designed as a one-way slab.

Solution

Let us consider the stress at PL in masonry AB between the window. Top lateral support on this masonry may be assumed to be at mid level of the beam that is, at a height of $5 + 0.15 - \frac{1}{2} \times 0.5$ = 4.9 m above the plinth level. Bottom support will be reckoned at the top of footing.

$$\text{Thus } H = 4.9 + 1.25$$

$$= 6.15 \text{ m}$$

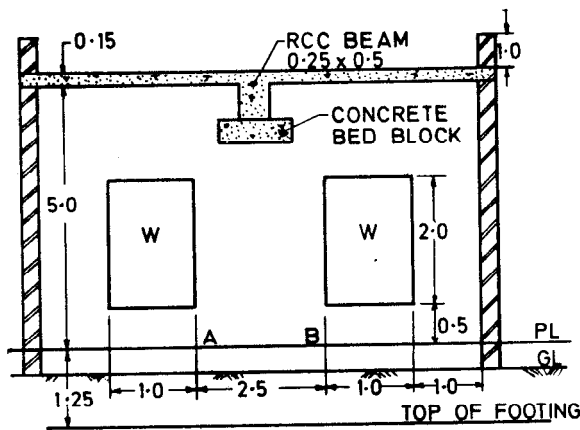

All dimensions in metres.

FIG. E-37

And effective height, h

$$= 0.75 \times 6.15 = 4.6 \text{ m}$$

Let us assume that wall is one brick that is, 23 cm thick, joints are raked for plastering on both faces of the wall, and overall thickness including plaster is 25 cm.

Thus effective thickness, t

$$= 23 - 1 - 2 \text{ (actual thickness of 23 cm wall is 22 cm)}$$

$$= 20 \text{ cm}$$

$$\text{Thus SR} = \frac{h}{t}$$

$$= \frac{4.6}{0.2}$$

$$= 23$$

In accordance with 4.6.1 and Table 7 of the Code maximum SR for a brick wall in cement mortar should not exceed 27. Thus thickness of wall is adequate from consideration of SR.

Stress in Masonry AB at PL

Concentrated load from beam is assumed to disperse to a maximum extent of $b + 4t$ where b is the width of bearing of beam and t is the effective thickness of wall (see Appendix D of the Code).

Thus

$$b + 4t = 25 + 4 \times 20$$

$$= 105 \text{ cm}$$

Therefore stress in masonry for concentrated load

$$= \frac{70 \times 10^3}{20 \times 105}$$

$$= 33.3 \text{ N/cm}^2 = 0.33 \text{ N/mm}^2$$

In addition there will be some stress in masonry due to self load of wall. Because of the window openings weight of 3.5 m length of wall, will be borne by 2.5 m length only. Height of masonry above the plinth

$$= 5.0 + 0.15 + 1.0$$

$$= 6.15 \text{ m}$$

Thus stress in masonry AB at plinth level due to self load of masonry

$$= \frac{20 \times 10^3 \times 0.25 \times 3.5 \times 6.15}{20 \times 2.5 \times 100}$$

$$= 21.5 \text{ N/cm}^2$$

$$= 0.22 \text{ N/mm}^2$$

It should be noted that for calculating self weight of masonry we take overall thickness inclusive of thickness of plaster which is $22 + 3 = 25$ cm and for the purpose of working out stress we take effective thickness which equals 20 cm.

Thus overall stress in masonry in question at PL

$$= 0.33 + 0.22$$

$$= 0.55 \text{ N/mm}^2$$

From Table 9 of the Code we get stress reduction factor k_s for SR 23 = 0.54. Thus Basic Compressive stress for masonry for unity Shape modification factor should be

$$f_b = \frac{f_c}{k_s}$$

$$= \frac{0.55}{0.54}$$

$$= 1.01 \text{ N/mm}^2$$

Referring to Table 8 of the Code strength of bricks to be used should be 12.5 N/mm^2 and grade of mortar should be M1. Since height to width ratio of units is less than 0.75 and strength of units is 15 N/mm^2 , shape modifier will be unity and no further modification is needed.

In case bricks of strength 12.5 N/mm^2 are not locally available we may either introduce piers of $1\frac{1}{2}$ brick thickness under the beams or change the thickness of entire wall to $1\frac{1}{2}$ brick that is, 34.5 cm. While considering the alternative with a pier under the beam, advantage may be taken of the provision in Note 5 under Table 4 of the Code. According to that Note if pier is kept $1\frac{1}{2}$ brick thick and wall is one brick thick, pier and wall will act as one structural element and thus it may be feasible to achieve a fairly economical design without having to make the entire wall $1\frac{1}{2}$ brick thick. Design should be worked out for both these alternatives and the one which is more economical should be adopted.

Let us now work out the bearing stress under the beam and examine the need for a bed block.

Bearing width of beam = .25 cm

Length of wall supporting the concentrated load equals the space between window openings which is $3.5 - 1 = 2.5$ meter. Since length of wall is more than 3 times the width of bearing, load from the beam would be treated as a concentrated load and 25 percent increase in bearing stress would be permissible (see Appendix D of the Code). Assuming that beam bears on full thickness of wall bearing stress

$$\begin{aligned} &= \frac{70 \times 10^3}{20 \times 25} \\ &= 140 \text{ N/cm}^2 \\ &= 1.40 \text{ N/mm}^2 \end{aligned}$$

Stress due to self load of masonry at bearing level

$$\begin{aligned} &= \frac{20 \times 10^3 \times 0.25(1.0 + 0.5)}{20 \times 100} \\ &= 3.8 \text{ N/cm}^2 \\ &= 0.04 \text{ N/mm}^2 \end{aligned}$$

$$\begin{aligned} \therefore \text{Overall} &= 1.40 + 0.04 \\ \text{stress} &= 1.44 \text{ N/mm}^2 \end{aligned}$$

Basic compressive stress of masonry from Table 8 of the Code

$$= 1.06 \text{ N/mm}^2$$

Permissible compressive stress immediately below the beam with $k_s = 1$

$$= 1.06 \text{ N/mm}^2$$

As explained in E-4.6(vii) when we invoke the provision of Note 3 below Table 9, we do not make any increase in permissible compressive stress, because of concentration of load, under 5.4.1.4(c) of the Code.

As bearing stress is more than permissible stress it would be necessary to provide concrete bed block under the beam. This design has been given later. Let us also check the stress in masonry at a depth of $\frac{H}{8}$ from the bottom of the beam. Angle of dispersal of the load in masonry may be assumed to be 30 degrees with the vertical (5.3.1 of the Code).

$$\begin{aligned} \text{Height of masonry up to bottom of beam, } H & \\ &= 5 - (0.50 - 0.15) + 1.25 \\ &= 5.9 \text{ m} \end{aligned}$$

It should be noted that for the portion of wall directly below the beam we have taken actual height to be the clear distance between the supports that is the bottom of beam and top of wall footing

$$\frac{H}{8} = \frac{5.9}{8} = 0.74$$

Thus length of wall supporting the concentrated load at a depth of 0.74 m

$$\begin{aligned} &= 0.25 + 2 \times 0.74 \times \tan 30^\circ \\ &= 0.25 + 2 \times 0.74 \times 0.577 \\ &= 0.25 + 0.85 \\ &= 1.1 \text{ m} \end{aligned}$$

Therefore stress in masonry from beam at a depth of $\frac{H}{8}$

$$\begin{aligned} &= \frac{70 \times 10^3}{20 \times 110} \\ &= 32 \text{ N/cm}^2 = 0.32 \text{ N/mm}^2 \end{aligned}$$

Stress in masonry due to self load of wall at $\frac{H}{8}$ that is 0.79 m below the beam

$$\begin{aligned} &= \frac{20 \times 10^3 \times 0.25 \times (1 + 0.5 + 0.79)}{20 \times 100} \\ &= 5.6 \text{ N/cm}^2 = 0.06 \text{ N/mm}^2 \end{aligned}$$

Therefore total stress

$$\begin{aligned} &= 0.32 + 0.06 \\ &= 0.38 \text{ N/mm}^2 \end{aligned}$$

Permissible compressive stress in masonry from SR 23

$$\begin{aligned} &= 1.06 \times k_s \\ &= 1.06 \times 0.535 \\ &= 0.57 \text{ N/mm}^2 \end{aligned}$$

Thus masonry is safe below $\frac{H}{8}$ height.

We have seen earlier that masonry is not safe in bearing under the beam. It is therefore necessary to provide a concrete bed block under the beam.

Design of concrete bed block

Through a concrete bed block, stress is assumed to spread at an angle of 45° to the vertical. Length of block should be such that compressive stress on masonry after spreading through the block reaches the permissible compressive stress value of masonry, which in this case is 0.57 N/mm^2 as worked out earlier. A simple method of working out length of block is the trial and error method.

Approximate length of block could be had from the relation

$$\begin{aligned} l \times 20 \times 0.57 &= 70 \times 10^3 \\ l &= \frac{70 \times 10^3}{20 \times 0.57} \\ &= 61 \text{ cm} \end{aligned}$$

In order to make some allowance for additional stress due to self load of masonry let us assume

length of block to be 70 cm. In that case depth of block should be (assuming angle of dispersion to be 45°)

$$\begin{aligned} &= \frac{70 - 25}{2} \\ &= 22.5 \text{ cm} \end{aligned}$$

It is desirable to adopt a depth in terms of number of brick Courses that is a multiple of nominal depth of bricks which is 7.7 cm. Thus let us make the depth to be 23 cm. We would now work out the actual stress at the bottom of this block and compare it with the permissible stress in masonry.

Stress due to beam load below the block

$$\begin{aligned} &= \frac{70 \times 10^3}{20 \times 70} \\ &= 50 \text{ N/cm}^2 \\ &= 0.5 \text{ N/mm}^2 \end{aligned}$$

Stress due to self load at the bottom of the bed block

$$\begin{aligned} &\frac{20 \times 10^3 \times 0.25(1 + 0.5 + 0.23)}{20 \times 100} \\ &= 4.33 \text{ N/cm}^2 = 0.04 \text{ N/mm}^2 \end{aligned}$$

Thus overall stress in masonry

$$\begin{aligned} &= 0.5 + 0.04 \\ &= 0.54 \text{ N/mm}^2 \end{aligned}$$

This is safe being less than permissible stress of 0.57 N/mm². Thus a concrete bed block 70 cm long and 23 cm deep of width same as thickness of wall should be provided below the beam.

Example 10 : Design of Walls of a Building with Cross Wall System of Load-bearing Construction

A 3 storeyed building as shown in Fig. E-38 has load bearing cross walls of 23 cm thickness. The building is subject to a wind pressure of 132/m². External longitudinal walls are also 23 cm thick while internal corridor walls are ½ brick thick. All walls are plastered both sides. Design the masonry for cross walls of first floor. Assume roof and floor loads (RCC slab) to be 7 kN/m². The building is without any parapet over the roof. Centre to centre height of floors is 3 m.

Solution

1) We will consider the design of a typical cross wall of first floor marked AA on the plant. Roof and floor loads borne by the typical cross walls is shown shaded on the plan in Fig. E-38. Height to width of the building equals

$$\frac{3 \times 3}{(20.5 + 0.44)} = 0.43,$$

which is much less than 2. As cross walls are

spaced 5 meter apart, in accordance with E-4.2.2.2 it is not necessary to work out wind stresses. However for the sake of illustration we will work out the stresses due to wind in the transverse direction.

2) *Loads*

Assume that roof and floor slabs are 15 cm thick. Since the building is only 3 storeyed, we would ignore the live-load reduction factor for the sake of simplicity. As structural system is based on cross wall construction, slabs are designed for one-way action so that slab load is supposed to come only on the cross walls. Since walls are plastered, joints of masonry are assumed to be raked.

$$\begin{aligned} \text{Roof/floor load per bay per floor} &= 7 \times 10^3 \times 5 \times 18.5 \\ &= 648 \text{ kN} \end{aligned}$$

$$\begin{aligned} \text{Self-load of cross wall per floor} &= 2 \times 20 \times 10^3 \times (0.22 + 0.03) \times 8 \times 3 \\ &= 240 \times 10^3 \text{ N} \\ &= 240 \text{ kN} \end{aligned}$$

$$\begin{aligned} \text{Self load of 2 corridor walls (½ brick thick) per floor per bay ignoring openings} &= 2 \times 20 \times 10^3 \times (0.105 + 0.03) \times 3 \times 5 \\ &= 81 \text{ kN} \end{aligned}$$

$$\begin{aligned} \text{Wind load per bay per floor} &= 1320 \times 5 \times 3 = 20 \times 10^3 \text{ N} \\ &= 2000 \text{ kg} \end{aligned}$$

3) *Direct Compressive Stress in Cross Wall Due to Vertical Loads*

$$\begin{aligned} \text{Total vertical load on cross walls AA of first floor at PL} &= 3(24000) + 2 \times 64800 + 2 \times 8100 \\ &= 2.18 \times 10^3 \text{ kN} \end{aligned}$$

$$\begin{aligned} \text{Area of the cross walls in plan per bay, assuming total depth of raking to be 2.0 cm.} &= 2 \times 8 \times (0.22 + 0.020) \\ &= 3.20 \text{ m}^2 \end{aligned}$$

$$\begin{aligned} \text{Thus direct Compressive stress in masonry due to vertical loads} &= \frac{2.18 \times 10^6}{3.20} \\ &= 7 \times 10^5 \text{ N/m}^2 \\ &= 0.7 \text{ N/mm}^2 \end{aligned}$$

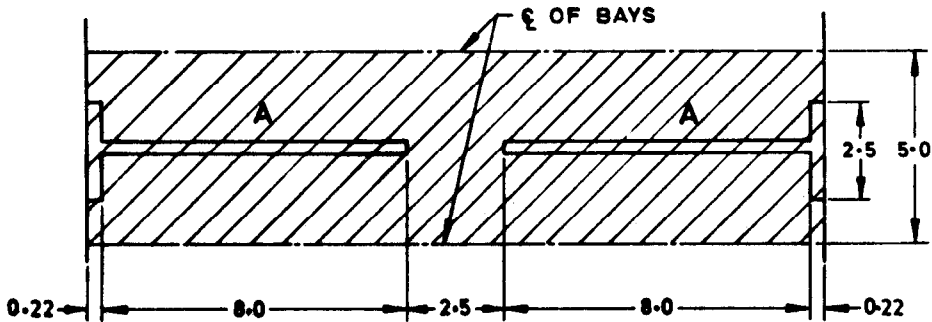
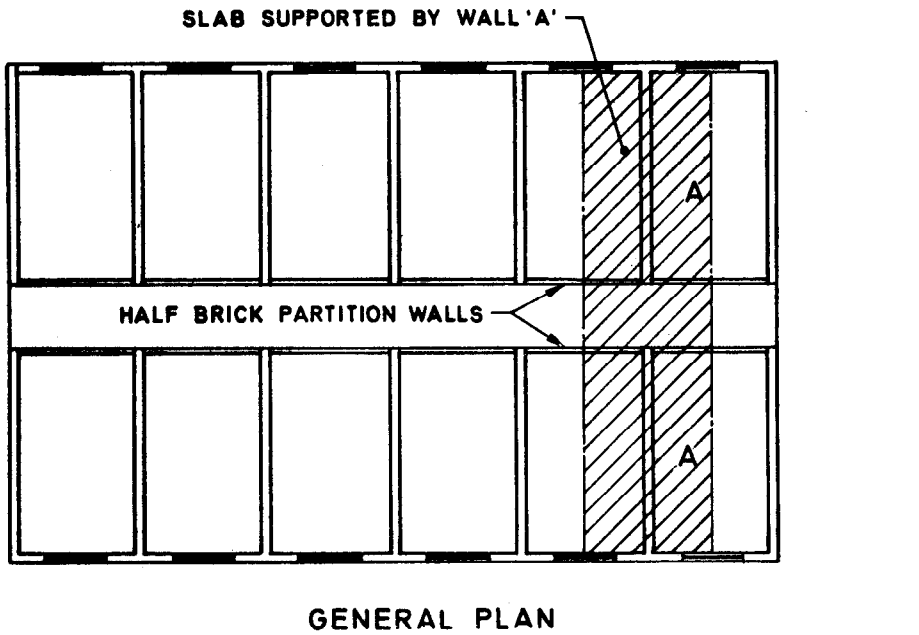

All dimensions in metres.

FIG. E-38

4) *Bending Stress Due to Wind Load*

Wind load normal to the main elevation per bay will be acting as shown in Fig. E-39.

Wind moments at plinth wall of the building per bay

$$= 10 \times 10^3 \times 3 \times 3 + 20 \times 10^3 \times 3 \times 2 + 20 \times 10^3 \times 3$$

$$= 270 \times 10^3 \text{ N.m}$$

Total wind moment in the entire building

$$= 270 \times 10^3 \times 6$$

$$= 1\,620 \text{ kN.m}$$

The above moment will be shared by various cross walls including end walls in the ratios of their respective stiffnesses, that is, moments of inertia.

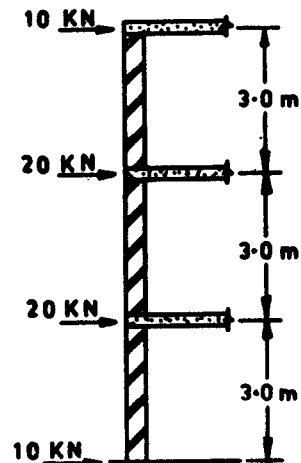

FIG. E-39•WIND FORCES ON ONE BAY

Moments of Inertia of inner cross wall (5 Nos):

In this case parts of the longitudinal wall will act as flanges to the cross walls, the maximum projecting flange length being actual distance between window openings and cross walls or 12 times the thickness of longitudinal wall or $\frac{H}{6}$ whichever is less (see 4.2.2.5 of the Code).

Distance between openings and cross wall

$$= 2.5 - 0.22$$

$$= 2.28 \text{ m}$$

12 time thickness of wall

$$= 12 \times 0.22$$

$$= 2.64 \text{ m}$$

$$H/6 = \frac{3 \times 3}{6}$$

$$= 1.5 \text{ m}$$

Thus overall effective flange width which will act along with the cross wall (see Fig. E-40) in resisting bending moment is

$$= 1.5 + 0.22$$

$$= 1.72 \text{ m}$$

Moment of inertia of cross wall AA inclusive of flanges

$$= \frac{0.22 \times (18.5)^3}{12} - \frac{0.22 \times 2.5^3}{12}$$

$$+ 2 \times 0.22 \times 1.72 \left(\frac{18.5 + 0.22}{2} \right)^2$$

$$= 116 - (\text{negligible}) + 66$$

$$= 182 \text{ m}^4$$

Moment of inertia for the end wall

In this case projecting flange length is to be limited to $6t$ or $\frac{H}{16}$, whichever is less

$$= \frac{3 \times 3}{16}$$

$$= 0.56 \text{ m}$$

Moment of Inertia (I) of one end wall

$$= \frac{0.22 \times (18.5)^3}{12} - \frac{0.22 \times 2.5^3}{12}$$

$$+ 2 \times 0.22 \times 0.76 \left(\frac{18.5 + 0.22}{2} \right)^2$$

$$= 116 - (\text{negligible}) + 29$$

$$= 145 \text{ m}^4$$

There are in all 5 cross walls and 2 end walls which are resisting the wind moment.

Thus B.M. borne by one inner cross wall AA.

$$= \frac{1\,620 \times 10^3 \times 182}{(182 \times 5 + 145 \times 2)} = 250 \times 10^3 \text{ N.m}$$

By comparison with the figure of 270 kN.m which is the wind moment per bay, it is obvious that as an approximation we could take wind on one cross wall to be equal to wind moment per bay.

Bending stress on cross wall due to wind moment

$$= \pm \frac{M y}{I}$$

$$= \pm \frac{250 \times 10^3}{182 \times 10^4} \times \left(\frac{18.5 + 0.44}{2} \right)$$

$$= \pm 0.013 \text{ N/mm}^2$$

Overall compressive stress in cross wall

$$= 0.7 \pm 0.013$$

$$= 0.713 \text{ N/mm}^2 \text{ or } 0.687 \text{ N/mm}^2$$

It is thus evident that when height/width ratio of a building is small, we need not in fact compute wind stresses in the masonry and could base our design only on direct compressive stress.

Let us now design the cross wall for overall compressive stress of 0.7 N/mm^2 as worked out above.

Slenderness ratio of wall, assuming that plinth level is 1.0 m above the top of footing

$$= \frac{h}{t}$$

$$= \frac{0.75(3.0 + 1.0)}{(0.22 - 0.025)}$$

$$= 15$$

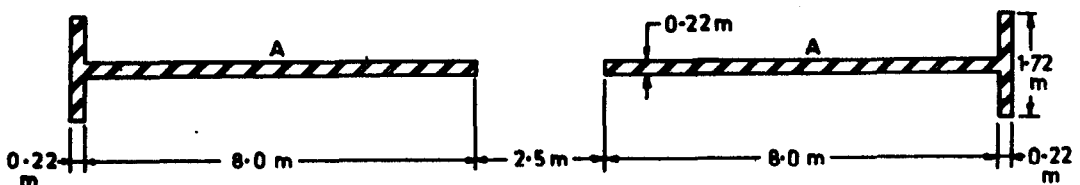

FIG. E-40 TYPICAL CROSS WALL WITH FLANGES

Stress reduction factor from Table 9 of the Code

$$= 0.76$$

Basic compress stress of masonry for unity
Shape modification factor

$$= \frac{f_c}{k_s}$$

$$= \frac{0.7}{0.76} = 0.92 \text{ N/mm}^2$$

Referring to Table 8 of the Code bricks should be of strength 10.0 N/mm² and mortar should be of grade M1.

In case of longitudinal walls, though lower grade masonry could be provided because of comparatively lighter loads, as a general rule same quality of bricks and grade of mortar are used for cross as well as longitudinal walls on one floor, since longitudinal walls are expected to contribute to the structural strength of cross walls.

Example 11 : Design of a Hall Subjected to Wind Load

A hall as shown in Fig. E-41 and of inside dimensions 10.0 m × 20.0 m with a clear height of 5.5 m up to the bottom of beam is to be constructed with load bearing masonry walls using modular bricks. Calculate thickness of walls, strength of bricks and grade of mortar for longitudinal and cross walls, assuming a wind pressure of 1 200 N/m².

Solution:

1) *Design Data/Assumptions*

Roof consists of RCC T-beams 40 cm × 80 cm with RCC slab 12 cm thick, beams being at 4.0 m centres. Roof is covered with lime concrete terrace of 15 cm average thickness.

Height of parapet = 20 cm above slab level

Plinth height = 0.5 m

Height of plinth above foundation footing

$$= 0.7 \text{ m}$$

2) *Minimum thickness of Walls*

According to 4.6.1 of the Code, maximum SR = 27, assuming cement or cement-lime mortar

Long wall

$$H = 0.7 + 5.5 + \frac{0.80}{2}$$

$$= 6.6 \text{ m}$$

(NOTE -Actual height has been reckoned from top of foundation footing up to middle of beam.)

$$h = 0.75 H = 0.75 \times 6.6 = 4.95 \text{ m}$$

$$SR = \frac{h}{t}$$

D - DOOR 1.5 × 2.5 W - WINDOW 1.5 × 2.0

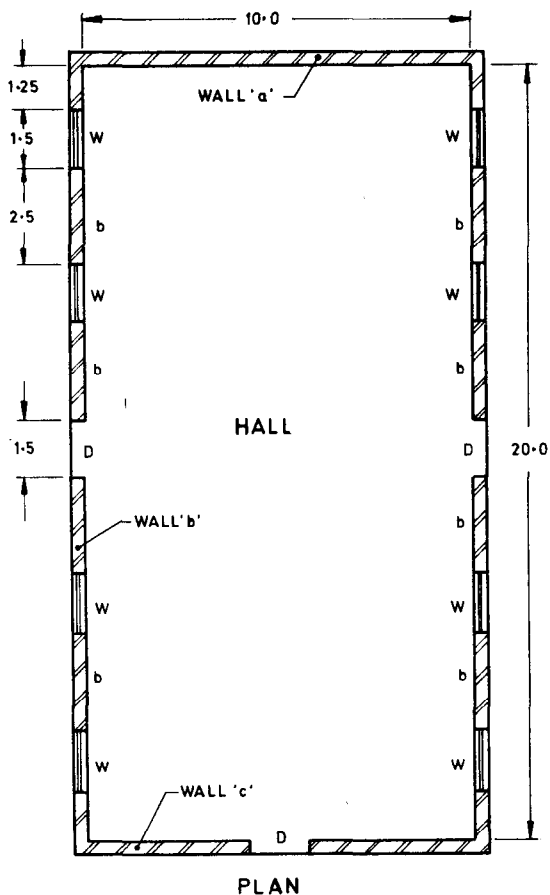

PLAN

All dimensions in metres.

FIG. E-41

$$\therefore t = \frac{h}{SR} = \frac{4.95}{27} = 18 \text{ cm}$$

In view of long spans and assuming that joints are raked to a depth of 1.0 cm on both sides adopt 1½ brick wall with actual thickness = 29 cm, that is, nominal thickness 30 cm.

Cross wall

$$H = 0.7 + 5.5 + (0.80 - 0.06)$$

(from top of footing to centre of slab)

$$= 6.94 \text{ m}$$

$$h = 0.75 H = 0.75 \times 6.94 \text{ m}$$

$$= 5.21 \text{ m}$$

$$t = \frac{h}{SR} = \frac{5.21}{27}$$

$$= 19 \text{ cm}$$

Adopt 30 cm nominal thickness for cross walls.

3) *Loads :*

Roof load

$$\text{RCC slab} = 12 \times 250 = 300 \text{ N/m}^2$$

$$\text{Terrace} = 15 \times 200 = 300 \text{ N/m}^2$$

$$\text{Live load} = \frac{1\ 500 \text{ N/m}^2}{7\ 500 \text{ N/m}^2}$$

$$\begin{aligned} \text{Self weight of beam} \\ &= \frac{40(80 - 12) \times 25\ 000}{100 \times 100} \\ &= 6\ 800 \text{ N/m} \end{aligned}$$

$$\begin{aligned} \text{Effective span of beam} \\ &= 10 + 0.3 \\ &\approx 10.3 \text{ m} \end{aligned}$$

Load on long walls

$$\begin{aligned} \text{Load from beam} &= (750 \times 4 + 680) \frac{10.3}{2} \\ &= 1\ 90\ 000 \text{ N} = 190 \text{ kN} \end{aligned}$$

Self load of wall including parapet assuming 3 cm plaster thickness. Since we will be considering combined stresses due to vertical loads and wind load, we will work out all loads at the top of foundation footing which is

$$\begin{aligned} (29 + 3) \frac{(0.7 + 5.5 + 0.8 + 0.2) \times 20 \times 10^3}{100} \\ &= 4.61 \times 10^4 \text{ N/m} \end{aligned}$$

Load on cross walls

$$\begin{aligned} \text{Slab load} &= \frac{7\ 500 \times 4}{2} = 15\ 000 \text{ N/m} \\ &= 15 \text{ kN/m} \end{aligned}$$

$$\begin{aligned} \text{Total load on wall at plinth level} \\ &= 46.1 + 15 = 61.1 \text{ kN/m} \end{aligned}$$

4) Stress in Walls Due to Vertical Loads

Longwall

2.5 m length of wall will bear weight of 4.0 m length of wall, because of openings.

∴ Stress at footing-top level due to self weight

$$\begin{aligned} &= \frac{4.61 \times 10^4 \times 4.0}{2.5 \times 26 \times 100} = 28.4 \text{ N/cm}^2 \\ &= 0.28 \text{ N/mm}^2 \end{aligned}$$

Stress due to concentrated load from beam

Load will spread on

$$\begin{aligned} b + 4t &= 0.04 + 4 \times 0.29 \\ &= 1.20 \text{ m length of wall} \end{aligned}$$

∴ Stress at plinth level due to concentrated load

$$\begin{aligned} &= \frac{1\ 90\ 000}{1.56 \times 26 \times 100} = 46 \text{ N/cm}^2 \\ &= 0.46 \text{ N/mm}^2 \end{aligned}$$

Therefore total axial at plinth level

$$\begin{aligned} &= 0.28 + 0.46 \\ &= 0.74 \text{ N/mm}^2 \end{aligned}$$

Cross wall without opening (Wall a)

$$\begin{aligned} \text{Compressive stress} &= \frac{61.1 \times 10^3}{26 \times 100} = 23.5 \text{ N/cm}^2 \\ &= 0.24 \text{ N/mm}^2 \end{aligned}$$

Cross wall with opening (Wall b)

$$\begin{aligned} \text{Compressive stress at plinth level} \\ &= \frac{61.1 \times 10^3}{(26 \times 100)} \times \frac{10}{(10 - 1.5)} = 27.6 \text{ N/cm}^2 \\ &= 0.28 \text{ N/mm}^2 \end{aligned}$$

(NOTE—The factor $\frac{10}{10 - 1.5}$ is to make allowance for increase in stress due to the door opening which is 1.5 m long.)

5) Stresses Due to Lateral Loads and Combined Stresses

i) Long walls

Since long walls are not adequately stiffened in accordance with the requirements of clause 4.2.2.2(b) of the Code and wall is longer than 8.0 m, it is necessary to work out bending stresses due to wind load in longitudinal as well as cross wall. Obviously wind load normal to the long walls will be critical and therefore we will work out bending stresses in long as well as cross walls on account of wind load normal to the long walls.

Wind load on long wall

$$\begin{aligned} \text{Wind load } P \text{ on long wall per bay} \\ &= p A \\ &= 1\ 200 \times 4 \times (5.5 + 0.8 + 0.2) \\ &= 31\ 200 \text{ N} = 31.2 \text{ kN} \end{aligned}$$

(Wind load on exposed portion of wall below plinth has been ignored)

$$\begin{aligned} \text{Total wind load for the building (5 bays)} \\ &= 31.20 \times 5 = 156 \text{ kN} \end{aligned}$$

Moments due to wind load on long wall

The walls are laterally supported at the top by RCC beams and slabs. It can be assumed that this lateral support will be adequate as a horizontal girder to transmit the wind force to the cross walls. The long wall will thus function as a propped cantilever and the maximum bending moment will be $\frac{pH}{8}$ at bottom support as shown in Fig. E-42.

$$\begin{aligned} \text{Maximum B.M. on long wall per bay} \\ &= \frac{pH}{8} \end{aligned}$$

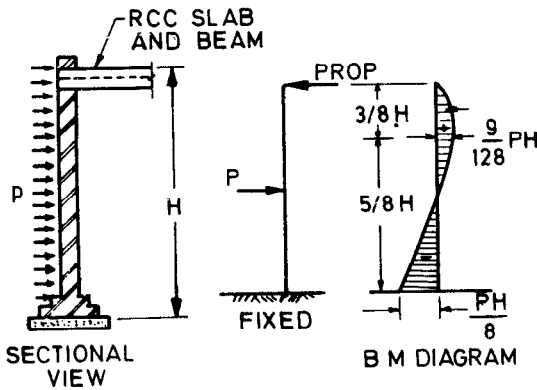

FIG. E-42

$$\begin{aligned}
 &= \frac{31\,200}{8} \times \left(0.7 + 5.5 + \frac{0.8}{2}\right) \\
 &= 31\,200 \times 6.6 \\
 &= 25\,740 \text{ N.m} \\
 &= 25.74 \text{ kN.m}
 \end{aligned}$$

We have erred on the safe side by including a small portion of height which is actually not exposed and thus not subject to any wind force.

Bending stress in long wall

$$\begin{aligned}
 f &= \frac{M}{Z} \\
 &= \frac{M \times 6}{b d^2} = \pm \frac{25.74 \times 10^3 \times 6}{4 \times 0.29^2 \times 10^4} \\
 &= \pm 46 \text{ N/cm}^2 \\
 &= \pm 0.46 \text{ N/mm}^2
 \end{aligned}$$

Combined stresses in long wall

$$\begin{aligned}
 &= \text{axial stress} + \text{bending stress} \\
 &= 0.74 \pm 0.46 = 1.20 \text{ N/mm}^2 \text{ or} \\
 &0.28 \text{ N/mm}^2 \text{ (both compression)}
 \end{aligned}$$

ii) Cross walls

Wind forces are shared by cross walls in the ratios of their stiffness. Since the cross walls are identical except for a small door opening in the middle in one wall, for practical purposes it may be assumed that wind loads are shared equally by the 2 walls.

Total wind load on a cross wall may be assumed to be acting at a plane at mid-height of the cross wall. Thus total B.M. on one cross wall

$$\begin{aligned}
 &= \frac{P}{2} \times \frac{H}{2} \\
 &= \frac{1\,56\,000 \times (0.7 + 5.5 + 0.8 + 0.2)}{2 \times 2} \\
 &= 280.8 \times 10^3 \text{ N.m}
 \end{aligned}$$

Moment of inertia of cross wall

A part of the long wall will act as a flange with the cross wall and effective overhanging length of flange (see 4.2.2.5 of the Code) will be actual length of wall up to window, that is,

$$\begin{aligned}
 &1.25 \text{ m or } 6t \text{ that is } 6 \times 0.20 \text{ or } \frac{H}{16} \text{ that is,} \\
 &\frac{0.7 + 5.5 + 0.8 + 0.2}{16} = 0.45 \text{ m}
 \end{aligned}$$

whichever is less, that is, 0.45 m. Thus *I* about neutral axis of the wall

$$\begin{aligned}
 &= \frac{0.29 \times 10^3}{12} + \frac{2(0.45 + 0.29) 0.29 \times 5.15^2}{12} \\
 &= 24 + 0.9 \\
 &= 24.9 \text{ m}^4
 \end{aligned}$$

Thus bending stresses at extreme fibres

$$\begin{aligned}
 f &= \pm \frac{M y}{I} \\
 &= \pm \frac{2\,80\,000 \times 5.29}{24.9 \times 10^4} \\
 &= \pm 6.0 \text{ N/cm}^2 \\
 &= 0.06 \text{ N/mm}^2
 \end{aligned}$$

Combined stress in cross walls

$$= \text{axial stress} + \text{bending stress}$$

In case of cross wall 'a' combined stresses are

$$= 0.24 \pm 0.06 = 0.30 \text{ N/mm}^2 \text{ or } 0.18 \text{ N/mm}^2 \text{ (both compressive)}$$

In case of cross wall 'b' combined stresses are

$$\begin{aligned}
 &= 2.8 \pm 0.6 = 2.28 \pm 0.06 \\
 &= 0.34 \text{ N/mm}^2 \text{ or } 0.22 \text{ N/mm}^2 \\
 &\text{(both compressive)}
 \end{aligned}$$

Check for shear stress in cross walls

We will consider wall 'b' which will have greater shear stress

Shear load on the cross wall

$$\begin{aligned}
 &= \frac{156 \times 10^3}{2} \\
 &= 78.0 \times 10^3 \text{ N}
 \end{aligned}$$

Section of wall being rectangular, we will assume parabolic shear distribution and maximum shear stress will be 1.5 times the average shear. Since flanges do not make any contribution for resisting shear load, maximum shear stress on wall

$$\begin{aligned}
 &= \frac{78.00 \times 10^3 \times 1.5}{0.26 \times (10^2 - 1.5) \times 10^4} \\
 &= 5.3 \text{ N/cm}^2 \\
 &= 0.05 \text{ N/mm}^2
 \end{aligned}$$

Permissible shear stress (see 5.4.3 of the Code), assuming mortar to be of M1 grade.

$f_s = 0.1 + f_d/6$ where f_d is axial compressive stress on the wall due to dead load.

f_d = stress due to self load of wall + stress due to dead load from slab

$$= \frac{61.1 \times 10^3 + 6 \times 10^3 \times 2}{26 \times 100}$$

$$= 28 \text{ N/cm}^2$$

$$= 0.28 \text{ N/mm}^2$$

Thus

$$f_s = 0.1 + \frac{0.28}{6}$$

$$= 0.14 \text{ N/mm}^2$$

Actual stress being only 0.50 N/mm^2 , wall is safe in shear. In fact since actual shear stress is about one third of permissible shear for M1 mortar, we could use M2 mortar. Thus both cross walls are safe in tension as well as shear.

6) Masonry for Walls

i) Long walls

Masonry of long walls should be designed for maximum compressive stress that is, 1.19 N/mm^2

$$\begin{aligned} \text{SR} &= \frac{h}{t} \\ &= \frac{0.75(0.7 + 5.5 + 0.4)}{0.26} \\ &= 19 \end{aligned}$$

Stress reduction factor k_s from Table 9 of the code

$$= 0.65$$

Therefore Basic compressive stress for masonry for unity

Shape modification factor

$$\begin{aligned} &= \frac{1.19}{0.65} \\ &= 1.83 \text{ N/mm}^2 \end{aligned}$$

Referring to Table 8 and Table 10, bricks should be of strength 25 N/mm^2 and mortar should be of grade H1. If bricks of this strength are not locally available it would be necessary to introduce piers under the beams so as to increase the supporting area thereby reducing stress in masonry.

ii) Masonry for cross walls

Masonry of cross wall should be designed for maximum compressive stress that is, 0.34 N/mm^2

$$\begin{aligned} \text{SR} &= \frac{h}{t} \\ &= \frac{0.75 \times (0.7 + 5.5 + 0.8 - 0.06)}{0.26} \\ &= 20 \end{aligned}$$

Stress reduction factor from Table 9

$$= 0.62$$

Basic compressive stress for unity Shape modification factor

$$= \frac{0.34}{0.62}$$

$$= 0.55 \text{ N/mm}^2$$

Referring to Tables 8 and 10 of the Code, bricks should be of strength 7.5 N/mm^2 and with Shape modification factor equal to 1.1.

Thus basic stress of masonry required

$$= \frac{0.55}{1.1} = 0.5 \text{ N/mm}^2$$

∴ Grade of mortar should be M3. However from the consideration of shear stress, we should use grade M2 mortar.

Example 12 : Design of Panel Walls

In a framed structure a panel wall (see Fig. E-43) of brickwork 23 cm thick is 4.5 m long and 3 m high (between centres of supports). If the panel is subjected to a horizontal wind pressure of 750 N/m^2 , determine the mix of mortar for the brickwork assuming:

- panel is supported at top and bottom and is free on other 2 edges,

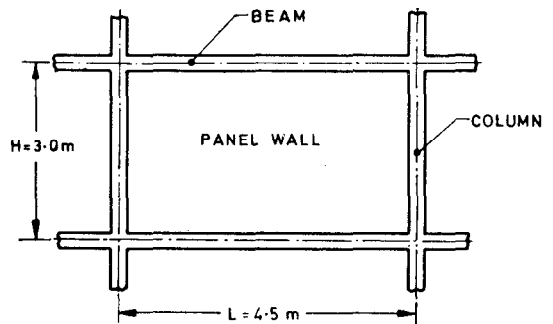

FIG. E-43 PANEL WALLS

- panel is free at the top and supported on other 3 edges, and
- panel is supported on all 4 edges.

Solution

Case (a)

In this case, panel is spanning in the vertical direction and maximum bending moment is

$$\begin{aligned} M &= \frac{PH}{8} \\ &= \frac{750 \times 3 \times 4.5 \times 3}{8} \end{aligned}$$

(see Appendix D of the Code)

$$= 3\,800 \text{ N.m}$$

$$f = \frac{M}{Z}$$

$$= \frac{3\,800 \times 6}{4.5 \times 0.22^2 \times 10^4}$$

$$= 0.11 \text{ N/mm}^2$$

Compressive stress (axial) in masonry due to self-weight at mid-height

$$= \frac{20 \times 10^3 \times 3}{10^4 \times 2}$$

$$= 3 \text{ N/cm}^2$$

$$= 0.03 \text{ N/mm}^2$$

∴ Maximum tensile stress

$$(0.11 - 0.03) = 0.08 \text{ N/mm}^2$$

If mortar used for masonry is 1 : 1 : 6 or better, tensile stress up to 0.07 N/mm^2 is permissible vide 5.6.2 of Code. It will thus be marginally safe in tension with M1 mortar. It may be clarified that even if joints are raked to serve as key for plaster, it is valid to base the design on full thickness of wall provided the wall has been plastered with mortar of grade not lower than M1.

Maximum compressive stress

$$= 0.11 + 0.03 = 0.14 \text{ N/mm}^2$$

Total shear force on panel

$$= 750 \times 4.5 \times 3$$

$$= 10\,130 \text{ N}$$

∴ Shear stress at supports

$$= \frac{10\,130}{2 \times 4.5 \times 0.22 \times 10^4}$$

$$= 0.51 \text{ N/cm}^2$$

$$= 0.005 \text{ N/mm}^2$$

This is safe being less than 0.1 N/mm^2

Case (b)

$$\frac{H}{L} \text{ Ratio} = 3/4.5$$

$$= 0.67$$

Since H/L ratio exceeds 0.3 and panel is free at top and supported on other 3 edges, maximum bending will be in the horizontal direction, and by interpolation from Table 12 of the Code it will be:

$$= 0.66 PL$$

$$= 0.66 \times 750 \times 4.5 \times 3 \times 4.5$$

$$= 3\,010 \text{ N.m}$$

Therefore tensile stress

$$= \frac{M}{Z} = \frac{3\,010 \times 6}{3 \times 0.22^2 \times 10^4} = 12.4 \text{ N/cm}^2$$

$$= 0.124 \text{ N/mm}^2$$

This is safe, being less than permissible limit of 0.14 N/mm^2 provided mortar of grade M1 or better and bricks of strength not less than 10 N/mm^2 are used.

Case (c)

In this case panel is supported on all 4 edges and $\frac{H}{L}$ ratio is

$$\frac{3}{4.5} = 0.67$$

From Table 13 of the Code (by interpolation), we get maximum bending moment M in the horizontal direction

$$= 0.038 \times 75 \times 4.5 \times 3 \times 4.5$$

$$= 1\,730 \text{ N.m.}$$

Thus the maximum tensile stress in the horizontal direction will be

$$= \frac{M}{Z}$$

$$= \frac{1\,730 \times 6}{3.0 \times 0.22^2 \times 10^4} = 7.2 \text{ N/cm}^2 = 0.072 \text{ N/mm}^2$$

$$= 0.048 \text{ N/mm}^2$$

This will be safe with mortar of M2 grade for which permissible tensile stress is 0.10 N/mm^2 for bending in the horizontal direction across bed joints.

Example 13 : Design of a Straight Free Standing Wall

A free standing brick wall 23 cm thick (see Fig. E-44) is subjected to a wind pressure of 750 N/m^2 . What should be the maximum height from consideration of stability, for mortars M1 and M2 grades.

Solution :

Code permits tension in masonry free standing walls to the extent of 0.07 N/mm^2 if mortar used is of M1 or better grade and 0.05 N/mm^2 if mortar used is of M2 grade.

Tensile stress f_t at the base of wall

$$= \frac{M}{Z} - \frac{W}{A}$$

$$= \frac{PH}{2Z} - \frac{wH \times A}{A}$$

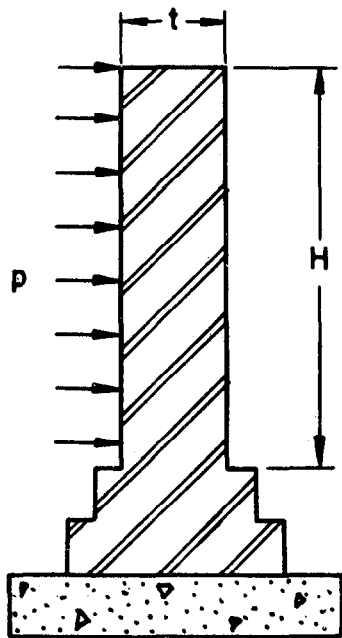

SECTIONAL ELEVATION

FIG. E-44

Considering 1 meter length of wall,

$$f_t = \frac{pH \times 6}{2 \times t^2} - wH$$

$$= \frac{3pH^2}{t^2} - wH$$

inserting value of $p = 750 \text{ N/m}^2$ and $w = 20 \times 10^3 \text{ N/m}^3$

$$\therefore f_t = \frac{2\,250\,H^2}{t^2} - 20 \times 10^3\,H$$

If mortar used is of M1 grade,

$$f_t = .07 \text{ N/mm}^2 = 70 \times 10^3 \text{ N/m}^2$$

For $t = 23 \text{ cm}$ nominal thickness, actual thickness = 22 cm

$$70 \times 10^3 = \frac{2\,250\,H^2}{0.22 \times 0.22} - 20\,000\,H$$

$$= 46\,500\,H^2 - 20\,000\,H$$

$$465\,H^2 - 200\,H - 700 = 0$$

This is a quadratic equation of the form

$ax^2 + bx + c = 0$ and its solution is

$$x = \frac{-b \pm \sqrt{b^2 - 4ac}}{2a}$$

Thus we get,

$$H = \frac{200 \pm \sqrt{200^2 + 4 \times 465 \times 700}}{2 \times 465}$$

$$= \frac{200 \pm 1\,158}{930}$$

$$= 1.46 \text{ m say } 1.5 \text{ m}$$

If we use 1 : 6 cement mortar (M2 grade)

$$f_t = 0.05 \text{ N/mm}^2$$

and from the above equation

$$50\,000 = \frac{2\,250\,H^2}{0.22 \times 0.22} - 20\,000\,H$$

$$465\,H^2 = 200\,H - 500 = 0$$

$$\therefore H = \frac{200 + \sqrt{(200)^2 + 4 \times 465 \times 500}}{2 \times 465}$$

$$= \frac{200 + 985}{930}$$

$$= 1.25 \text{ m}$$

In urban areas it is a common practice to build a 23 cm thick courtyard wall for houses in 1 : 6 cement mortar, plastered on both sides up to a height of about 2 meters. It has proved to be generally safe, because the wall is braced by cross walls.

The Code permits higher tensile stress in the case of boundary/courtyard walls at the discretion of the designer (see Note 2 of 5.4.2 of the Code). Thus if we design a 23 cm wall for a tensile stress of 0.1 N/mm^2 , as is permissible for M1 mortar, we get a safe design height of 1.7 m as follows:

$$465\,H^2 - 200\,H - 1\,000 = 0$$

$$H = \frac{200 + \sqrt{(200)^2 + 4 \times 465 \times 1\,000}}{2 \times 465}$$

$$= 1.7 \text{ m.}$$

Example 14 : Design of a Staggered Free Standing Wall

A brick masonry wall of staggered shape (see Fig. E-45) is 23 cm thick and is subject to a wind pressure 750 N/m^2 . Determine the maximum height of the wall if mortar used is: (a) 1 cement : 1 lime : 6 sand (M1 grade), (b) 1 cement : 6 sand (M2 grade).

(a) Consider module length AB of the wall which is $2.31 + 0.22 = 2.53 \text{ m}$ long. If f_t is the permissible tensile stress in masonry

$$f_t = \frac{My}{I} - \frac{W}{A}$$

$$M = p \times 2.53 \times \frac{H^2}{2}$$

$$= \frac{750 \times 2.53\,H^2}{2}$$

$$= 950\,H^2 \text{ N.m}$$

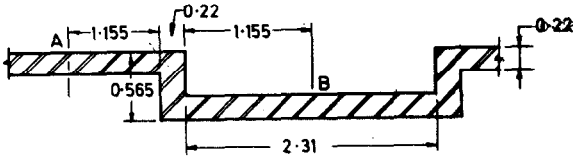

All dimensions in metres.

FIG. E-45 PLAN VIEW OF A STAGGERED WALL

I , around N.A of the wall

$$= 2 \left[1.155 \times \frac{0.22^3}{12} + 1.155 \times 0.22 \times (0.565 - 0.22)^2 \right] + \frac{0.22 \times 0.565^3}{12}$$

$$= 2 (0.001 025 + 0.007 561) + 0.003 307$$

$$= 2 \times 0.085 86 + 0.003 807$$

$$= 0.17 2 + 0.003 31$$

$$= 0.205 \text{ m}^4$$

$$y = \frac{0.565}{2}$$

$$= 0.282 \text{ m}$$

Thus inserting values in the equation:

$$f_t = \frac{My}{I} - wH$$

$$= \frac{950 H^2 \times 0.282}{0.205} - 20 000 H \text{ (N/m}^2\text{)}$$

$$= 1 310 H^2 - 2 000 H$$

Permissible value of tension for 1 : 1 : 6.

Cement mortar across bed joint

$$= 0.07 \text{ N/mm}^2 = 70 \times 10^3 \text{ N/m}^2$$

$$\therefore 700 = 131 H^2 - 200 H$$

$$131 H^2 - 200 H - 700 = 0$$

Solving this quadratic equation we get

$$H = \frac{200 + \sqrt{200^2 + 4 \times 131 \times 700}}{2 \times 131}$$

$$= \frac{200 + 638}{262}$$

$$= 3.2 \text{ metres}$$

b) If mortar used is of 1 cement : 6 sand mix (M2 grade), value of permissible tensile stress is $0.05 \text{ N/mm}^2 = 50 \times 10^3 \text{ N/m}^2$. Substituting in the above equation,

$$5 000 = 1 310 H^2 - 2 000 H$$

$$131 H^2 - 200 H - 500 = 0$$

Solving this equation for H we get

$$H = \frac{200 + \sqrt{200^2 + 4 \times 131 \times 500}}{2 \times 131}$$

$$= \frac{200 + 550}{262}$$

$$= 2.86 \text{ m say } 2.8 \text{ m}$$

NOTE—While planning and designing a free standing staggered wall, it should be borne in mind that total length of projecting flanges on either side of a rib should not exceed 6 times the flange thickness. In other words module of a staggered wall should be limited to 12 times the thickness of wall plus width of the rib or pier formed by staggering. Thus in the above example upper limit of module works out to $12 \times 0.22 + 0.22 = 2.86 \text{ m}$ as against 2.50 actually provided in the wall in question.

Example 15 : Design of a Diaphragm Type Free Standing Wall

A brick masonry wall (see Fig. E-46) is built in mortar of grade M1. Find the maximum safe height for this wall, when it is subjected to a wind velocity of 47 m/s and is located in a built up urban area. Bricks used are of format size $23 \times 11.5 \times 7.7 \text{ cm}$.

In accordance with IS 875(Part 3) : 1987, wind pressure, $p_z = 0.6 V_z^2$, where V_z stands for design wind speed

$$(= V_b k_1 k_2).$$

V_b is regional basic wind speed and k_1, k_2, k_3 are modification factors

$$k_1 \text{ (for a boundry wall)} = 0.73$$

$$k_2 = 0.91$$

$$k_3 = 1.0$$

$$\therefore p_z = 0.6 \times (47 \times 0.73 \times 0.91)^2$$

$$= 750 \text{ N/m}^2$$

Consider the diaphragm unit of length B and if H be the height of the wall in metres, then Bending Moment

$$M = \frac{pH^2}{2} = p(BH) \times \frac{H}{2} = \frac{pBH^2}{2}$$

$$B = 1.27 \text{ m and } p = 750 \text{ N/m}^2$$

$$\therefore M = \frac{750 \times 1.27 \times H^2}{2} = 476 H^2$$

$$f_t = \frac{My}{I} - \frac{W}{A}$$

$$= \frac{My}{I} - wH \dots \text{(Eqn 'X')}$$

w being the unit weight of masonry

$$I = \frac{BD^3}{12} - \frac{bd^3}{12}$$

(referring to Fig. E-46)

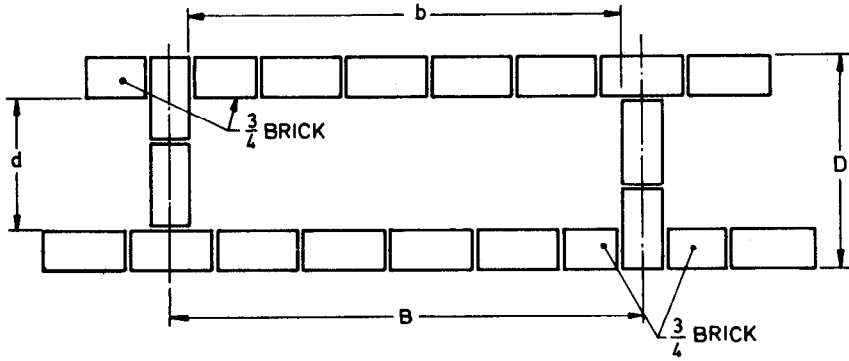

$B = 126.75$ cm, $b = 116.25$ cm

$D = 56.5$ cm, $d = 35.5$ cm

NOTE: For proper bond some bricks are $\frac{3}{4}$ size as shown in plan view of a diaphragm wall.

FIG. E-46 PLAN VIEW OF A DIAPHRAGM WALL

$D = 56.5$ cm and $d = 35.5$ cm

Taking all units in metres,

$$I = \frac{1.27 \times 0.565^3}{12} - \frac{1.16 \times 0.355^3}{12}$$

$$= 0.019 \times 0.0043$$

$$= 0.0147 \text{ m}^4$$

$$y = \frac{D}{2}$$

$$= \frac{0.565}{2}$$

$$= 0.282$$

In accordance with the Code, permissible tension in masonry with mortar M1 is

$$0.07 \text{ N/mm}^2 = 70\,000 \text{ N/m}^2$$

$$\text{and } W = 20\,000 \text{ N/m}^3$$

Thus inserting values in the above Eqn 'X' we get

$$70\,000 = \frac{476 H^2 \times 0.282}{0.0147} - 20\,000 H$$

$$= 9\,130 H^2 - 20\,000 H$$

Transposing and simplifying,

$$913 H^2 - 20\,000 H - 7\,000 = 0$$

Solving this quadratic equation we get

$$\therefore H = \frac{2\,000 + \sqrt{2\,000^2 + 4 \times 913 \times 7\,000}}{2 \times 913}$$

$$= \frac{2\,000 + 5\,437}{1\,826}$$

$$= 4.07 \text{ m} = 4.0 \text{ m (say)}$$

If mortar used is of M2 grade, $f_t = 50\,000 \text{ N/m}^2$ then we get $H = 3.6$ m.

It will be of interest to compare the economy of straight, staggered and diaphragm type free standing walls as considered for design in Examples 13, 14 and 15.

Straight Walls

Area of wall per metre length = $0.22 \times 1 = 0.22 \text{ m}^2$. This wall for a wind pressure of 750 N/m^2 can be taken to a height of 1.5 m using M1 mortar and to a height of 1.25 m using M2 mortar.

Staggered Wall

Area of wall for module length of 2.53 m

$$= 2.31 \times 0.22 + 0.22 \times 0.565$$

$$= 0.508 + 0.124$$

$$= 0.632 \text{ m}^2$$

Area per metre length

$$= \frac{0.632}{2.53}$$

$$= 0.25 \text{ m}^2$$

For the same wind pressure, this wall can be taken to height of 3.2 metres with M1 mortar and 2.8 m with M2 mortar.

Diaphragm Wall

Area for one diaphragm length

$$= 1.268 \times 0.565 - 1.163 \times 0.355$$

$$= 0.303 \text{ m}^2$$

Area per metre length

$$= \frac{0.303}{1.268}$$

$$= 0.24 \text{ m}^2$$

This wall can be built to a height of 4.0 m, with M1 mortar and to a height of 3.6 m with M2 mortar. Diaphragm walls can be used with great

advantage and economy in single storeyed tall structures for warehouses, factories and large halls, etc.

ANNEX H-2

DESIGN OF BRICK MASONRY FOR RESIDENTIAL BUILDINGS UP TO 3 STOREYS

H-2.1 Design Parameters

	Maximum Span (Short Span in Case of 2-Way Slab) m	Clear Height of Storey m	Live Load on Floors kg/cm ²
Case 1	3.00	2.70	150
Case 2	3.60	2.70	150
Case 3	3.00	2.70	200
Case 4	3.00	3.00	200
Case 5	3.60	2.70	200
Case 6	3.60	3.00	200
Case 7	4.20	2.70	200
Case 8	4.20	3.00	200

H-2.2 Assumptions

	For All Cases		
	For Cases 1, 3 and 4	For Cases 2, 5 and 6	For Cases 7 and 8
H-2.2.1 Height of plinth from ground level	0.5 m		
H-2.2.2 Height of plinth above footing top	1.0 m		
H-2.2.3 Height of parapet wall above RCC roof slab	1.0 m		
H-2.2.4 Thickness of RCC roof/floor slab	10 cm	12 cm	14 cm
H-2.2.5 Thickness of lime concrete over roof slab (average)	10 cm	12 cm	14 cm
	For All Cases		
H-2.2.6 Thickness of ceiling finish	1 cm		
H-2.2.7 Thickness of cement concrete flooring	4 cm		

H-2.2.8 Wall plastered on both sides, 3 cm total plaster thickness

H-2.2.9 Length to width ratio, span ratio of rooms 1.30

H-2.2.10 Openings in walls as percentage of area of walls in plan

- a) In external wall 45 percent
- b) In internal wall 30 percent

H-2.2.11 The bricks used in masonry are modular bricks of nominal size 20 × 10 × 10 cm.

H-2.2.12 Openings in a wall are so shaped and located that:

- a) In load bearing walls, openings do not occur within $\frac{H}{8}$ distance from a cross wall, that function as a stiffening wall, and length of cross wall is not less than $\frac{H}{6}$ (see 4.6 and Fig. 9 of the Code and also comments on 4.4 of the Code).
- b) The horizontal area of brickwork in any wall is not less than 2 000 cm².
- c) The brickwork between two consecutive openings does not become a column by definition.

NOTE -- In case area of brickwork in any wall is less than 2 000 cm² or becomes a column by definition, stress in the actual portions shall be checked by calculations.

H-2.2.13 RCC roof/floor bears fully on external masonry walls; thus eccentricity over wall has been assumed to be negligible.

H-2.2.14 The RCC slabs are designed as two-way slabs, thus loads on wall are shared accordingly.

H-2.3 Design Steps

H-2.3.1 Slenderness Ratio (SR) and Stress Factor (K_s)

Slenderness ratio and stress factor have been calculated and are given in Table E-12 for each case (see E-12).

Table E-12 Slenderness Ratio and Stress Factor

Particulars	Case 1	Case 2	Case 4	Case 6	Case 7	Case 8
	& Case 3	& Case 5				
1. Third and second storey						
a) Actual height H in m (centre to centre of structural slab)	2.85	2.87	3.15	3.17	2.89	3.19
b) Effective height $h = 0.75 H$ from Table 1 of the Code	2.14	2.15	2.36	2.18	2.17	2.39
c) $SR = \frac{h}{t}$ for $t = 19$ cm	11.3	11.3	12.4	12.5	11.4	12.6
d) Stress factor K_s for SR given above in (c) from Table 9 of the Code	0.86	0.86	0.83	0.83	0.86	0.83
2. First storey						
a) Actual height H in m (from top of footing to the centre of slab)	3.76	3.77	4.06	4.07	3.78	4.08
b) Effective height $h = 0.75 H$ according to Table 1 of the Code	2.82	2.83	3.05	3.05	2.84	3.06
c) $SR = \frac{h}{t}$ for $t = 19$ cm	14.8	14.9	16.0	16.1	14.9	16.1
d) Stress factor K_s for SR given above in (c) from Table 5 of the Code	0.76	0.76	0.73	0.73	0.76	0.73
e) $SR = \frac{h}{t}$ for $t = 29$ cm	9.7	9.8	10.5	10.5	9.8	10.6
f) Stress factor K_s for SR given above in (e) from Table 9 of the Code	0.90	0.90	0.88	0.88	0.90	0.88

H-2.3.2 Loads

H-2.3.2.1 Unit weights

For calculating the loads of different components of the building, the following unit weights of materials have been taken:

- a) RCC up to 2 percent steel = 2 500 kg/m³
- b) Lime concrete = 2 000 kg/m³
- c) Cement concrete flooring = 2 400 kg/m³
- d) Brickwork including plaster = 2 000 kg/m³

H-2.3.2.2 Load distribution factors

The RCC slab is assumed as two way slab for loading purposes. The roof/floor slab loads on the supporting walls have been worked out in accordance with 23.5 and Fig. 6 of IS 456 : 1978.

For the assumed span ratio of 1.3, the load distribution factor has been worked out in accordance with Fig. 6 of IS 456 : 1978 which is as follows:

- a) For shorter span = 0.62
- b) For longer span = 0.38

H-2.3.2.3 Unit loads of roof/floor, roof/floor load over different walls, self weight of wall of different thickness including parapet walls have been calculated and tabulated in Table E-13.

H-2.3.3 Shape Modification Factor

Assuming that modular bricks of size 20 × 10 ×

10 cm are used in brick masonry, shape modification factor for bricks of 5.0, 7.5, 10.0 and 15.0 N/mm² strength will be 1.2, 1.1, 1.1 and 1.0 respectively, in accordance with Table 10 of the Code. Thus for determining the particulars of masonry required for any situation, values of basic stress as arrived at without application of shape modification factor will be divided by the above factors and values of basic stress thus obtained, taken into consideration.

H-2.3.4 Compressive Stress in Masonry and Particulars of Requisite Masonry

Following steps have been adopted for calculation of loads and stresses for each case which have then been tabulated:

- Step (1) — Calculation of loads on external and internal walls taking into account parapet load, roof/floor load and self load of walls.
- Step (2) — Working out compressive stress in masonry assuming that there are no openings.
- Step (3) — Working out compressive stress after making allowance for openings.
- Step (4) — Working out requisite basic stress after applying stress reduction factor but without applying shape modification factor as per 5.4.1.3 of the Code.

Table E-13 Unit Loads of Roof/Floor and Walls

Particulars	Loads							
	Case 1	Case 2	Case 3	Case 4	Case 5	Case 6	Case 7	Case 8
1. <i>Dead load and live load in kg/m²:</i>								
i) Roof	625	715	625	625	715	715	805	805
ii) Floor	525	575	575	575	625	625	675	675
2. <i>Roof load on walls in kg/m:</i>								
i) External wall	600	830	600	600	830	830	1 080	1 080
ii) Internal wall	1 200	1 650	1 200	1 200	1 650	1 650	2 170	2 170
3. <i>Floor load on walls in kg/m:</i>								
i) External wall	510	660	550	550	720	720	910	910
ii) Internal wall	1 010	1 330	1 110	1 110	1 440	1 440	1 810	1 810
4. <i>Self weight of wall in kg/m per storey (including 3 cm thick plastering):</i>								
i) For 19 cm thick wall	1 250	1 260	1 250	1 390	1 260	1 400	1 270	1 400
ii) For 29 cm thick wall	1 820	1 840	1 820	2 020	1 840	2 030	1 850	2 040
5. <i>Self weight of parapet wall (19 cm thick) in kg/m (including 3 cm thick plastering)</i>	440	440	440	440	440	440	440	440

Step (5)—Working out values of requisite basic stress after applying shape modification factor.

Step (6)—Determining the masonry requirements for triple, double and single storey buildings with reference to Table 8 of the Code.

H-2.3.5 Important notes in regard to tables for all cases are given below:

- Figures have been rounded off suitably to simplify calculations.
- The symbols *FL1*, *FL2* and *FL3* have been used to indicate Floor 1 (first floor), Floor 2 (second floor) and Floor 3 (third floor) respectively in accordance with IS 2332 : 1972. Here, the floor '1' has been defined as the lowest floor in the building with direct entrance from the road.
- For the sake of convenience of reference, the brick masonry requirement has been designated symbolically in the tables. For example, 20-7-M2 means masonry with 20 cm thick wall using bricks with minimum crushing strength of 7 N/mm² and mortar Type M2. Standard types of mortar have been given for different mix ratios of cement, lime and sand in Table 1 of the Code.
- No deductions in self weight of walls due to openings and no reduction in live loads have been made in the calculations since design calculations for masonry cannot be very

precise, thus that refinement is not called for.

- In case of first storey *SR* applicable to that storey wall is based on height from top of foundation footing to centre of floor slab. Since, we are increasing the stresses due to openings and openings start from floor 1 level, we get the maximum stress at floor 1 level. Below that level, as, there are no openings, loads on walls will start dispersing and thus, in spite of increase in dead load of masonry, no increase in stress will take place below floor 1 level unless the percentage of openings taken into consideration is very small. Thus stresses in case of first storey have been calculated at floor 1 level.
- No provision has been made for any wind force in the design calculations and it has been assumed that the building as a whole is stable against all loads.
- No allowance has been made for seismic forces and, therefore, when applying these results for structures in seismic zones other than I and II, strengthening measures as given in IS 4326 : 1976 shall be adopted. (see 6.1.2 of the Code).
- In marginal cases, actual stress (basic) may exceed the permissible stress by a maximum of 10 percent, provided sufficient precautions are taken about the quality of materials and workmanship and work is done under good technical supervision. Alternatively, percentage of openings in walls may be reduced suitably to bring down the actual stress to permissible limits.

Case 1 Loads and Stresses

Particulars (1)	External Wall		Internal Wall		Remarks (6)
	Individual Load	Progressive Load	Individual Load	Progressive Load	
	kg/m	kg/m	kg/m	kg/m	
(2)	(3)	(4)	(5)	(6)	
Parapet Wall	440	440	—	—	
Roof	600	1 040	1 200	1 200	
Third storey wall	1 250	2 290	1 250	2 450	
Floor 3	510	2 800	1 010	3 460	
Second storey wall	1 250	4 050	1 250	4 710	
Floor 2	510	4 560	1 010	5 720	
First storey wall	1 250	5 810	1 250	6 970	
		kg/cm ²		kg/cm ²	
Compressive stress in masonry wall without openings	FL 3	$\frac{2\,290}{19 \times 100} = 1.21$		$\frac{2\,450}{19 \times 100} = 1.29$	
	FL 2	$\frac{4\,050}{19 \times 100} = 2.13$		$\frac{4\,710}{19 \times 100} = 2.48$	
	FL 1	$\frac{5\,810}{19 \times 100} = 3.06$		$\frac{6\,970}{19 \times 100} = 3.67$	
Compressive stress in masonry wall with openings	FL 3	$\frac{1.21}{0.55} = 2.20$		$\frac{1.29}{0.70} = 1.84$	
	FL 2	$\frac{2.13}{0.55} = 3.87$		$\frac{2.48}{0.70} = 3.54$	
	FL 1	$\frac{3.06}{0.55} = 5.56$		$\frac{3.67}{0.70} = 5.24$	
<i>For Three-Storeyed Building</i>					
Basic stress of requisite masonry without application of shape modification factor	FL 3	$\frac{2.20}{0.86} = 2.56$		$\frac{1.84}{0.86} = 2.14$	$K_s = 0.86$
	FL 2	$\frac{3.87}{0.86} = 4.50$		$\frac{3.54}{0.86} = 4.12$	$K_s = 0.86$
	FL 1	$\frac{5.56}{0.76} = 7.32$		$\frac{5.24}{0.76} = 6.89$	$K_s = 0.76$
Basic stress of requisite masonry after application of shape modification factor	FL 3	$\frac{2.56}{1.2} = 2.1$		$\frac{2.14}{1.2} = 1.8$	
	FL 2	$\frac{4.50}{1.1} = 4.1$		$\frac{4.12}{1.1} = 3.7$	
	FL 1	$\frac{7.32}{1.1} = 6.7$		$\frac{6.89}{1.1} = 6.3$	
Masonry requirements	FL 3	20-3.5-L2		20-3.5-L2	
	FL 2	20-5.0-M3		20-5.0-M3	
	FL 1	20-7.5-M1		20-7.5-M1	

(Continued)

Case 1—Concluded

Particulars		External Wall		Internal Wall		Remarks
<i>For Two-Storeyed Building</i>						
			kg/cm ²		kg/cm ²	
Basic stress of requisite masonry without application of shape modification factor	FL 2	$\frac{2.20}{0.86}$	= 2.56	$\frac{1.84}{0.86}$	= 2.14	$K_s = 0.86$
	FL 1	$\frac{3.87}{0.76}$	= 5.09	$\frac{3.54}{0.76}$	= 4.66	$K_s = 0.76$
Basic stress of requisite masonry after application of shape modification factor	FL 2	$\frac{2.56}{1.2}$	= 1.1	$\frac{2.14}{1.2}$	= 1.8	
	FL 1	$\frac{5.09}{1.1}$	= 4.6	$\frac{4.66}{1.1}$	= 4.2	
Masonry requirements	FL 2	20-3.5-L2		20-3.5-L2		
	FL 1	20-5.0-M1		20-5.0-M2		
<i>For One-Storeyed Building</i>						
Basic stress of requisite masonry without application of shape modification factor	FL 1	$\frac{2.20}{0.76}$	= 2.89	$\frac{1.84}{0.76}$	= 2.42	$K_s = 0.76$
	FL 1	$\frac{2.89}{1.2}$	= 2.4	$\frac{2.42}{1.2}$	= 2.0	
Masonry requirements	FL 1	20-3.5-L2		20-3.5-L2		

Case 2 Loads and Stresses

Particulars	External Wall		Internal Wall		Remarks
	Individual Load	Progressive Load	Individual Load	Progressive Load	
(1)	kg/m	kg/m	kg/m	kg/m	(6)
(1)	(2)	(3)	(4)	(5)	(6)
Parapet Wall	440	440	—	—	
Roof	830	1 270	1 650	1 650	
Third storey wall	1 260	2 530	1 260	2 910	
Floor 3	660	3 190	1 330	4 240	
Second storey wall	1 260	4 450	1 260	5 500	
Floor 2	660	5 110	1 330	6 830	
First storey wall	1 260	6 370	1 260	8 090	
		kg/cm ²		kg/cm ²	
Compressive stress in masonry wall without openings	<i>FL 3</i>	$\frac{2\ 530}{19 \times 100} = 1.33$	$\frac{2\ 910}{19 \times 100} = 1.53$		
	<i>FL 2</i>	$\frac{4\ 450}{19 \times 100} = 2.34$	$\frac{5\ 500}{19 \times 100} = 2.89$		
	<i>FL 1</i>	$\frac{6\ 370}{19 \times 100} = 3.35$	$\frac{8\ 090}{19 \times 100} = 4.26$		
Compressive stress in masonry wall with openings	<i>FL 3</i>	$\frac{1.33}{0.55} = 2.42$	$\frac{1.53}{0.70} = 2.19$		
	<i>FL 2</i>	$\frac{2.34}{0.55} = 4.25$	$\frac{2.89}{0.70} = 4.13$		
	<i>FL 1</i>	$\frac{3.35}{0.55} = 6.09$	$\frac{4.26}{0.70} = 6.09$		
<i>For Three-Storeyed Building</i>					
Basic stress of requisite masonry without application of shape modification factor	<i>FL 3</i>	$\frac{2.42}{0.86} = 2.81$	$\frac{2.19}{0.86} = 2.55$		$K_s = 0.86$
	<i>FL 2</i>	$\frac{4.25}{0.86} = 4.94$	$\frac{4.13}{0.86} = 4.80$		$K_s = 0.86$
	<i>FL 1</i>	$\frac{6.09}{0.76} = 8.01$	$\frac{6.09}{0.76} = 8.01$		$K_s = 0.76$
Basic stress of requisite masonry after application of shape modification factor	<i>FL 3</i>	$\frac{2.81}{1.2} = 2.3$	$\frac{2.55}{1.2} = 2.1$		
	<i>FL 2</i>	$\frac{4.94}{1.1} = 4.5$	$\frac{4.80}{1.1} = 4.4$		
	<i>FL 1</i>	$\frac{8.01}{1.1} = 7.3$	$\frac{8.01}{1.1} = 7.3$		
Masonry requirements	<i>FL 3</i>	20-3.5-L2	20-3.5-L2		
	<i>FL 2</i>	20-5.0-M1	20-5.0-M2		
	<i>FL 1</i>	20-7.5-M1	20-7.5-M1		

(Continued)

Case 2—Concluded

Particulars		External Wall		Internal Wall		Remarks
<i>For Two-Storeyed Building</i>						
			kg/cm ²		kg/cm ²	
Basic stress of requisite masonry without application of shape modification factor	FL 2	$\frac{2.42}{0.86}$	= 2.81	$\frac{2.19}{0.86}$	= 2.55	$K_s = 0.86$
	FL 1	$\frac{4.25}{0.76}$	= 5.59	$\frac{4.13}{0.76}$	= 5.43	$K_s = 0.76$
Basic stress of requisite masonry after application of shape modification factor	FL 2	$\frac{2.81}{1.2}$	= 2.3	$\frac{2.55}{1.2}$	= 2.1	
	FL 1	$\frac{5.59}{1.1}$	= 5.1	$\frac{5.43}{1.1}$	= 4.9	
Masonry requirements	FL 2	20-3.5-L2		20-3.5-L2		
	FL 1	20-5.0-M1		20-5.0-M1		
<i>For One-Storeyed Building</i>						
Basic stress of requisite masonry without application of shape modification factor	FL 1	$\frac{2.42}{0.76}$	= 3.18	$\frac{2.19}{0.76}$	= 2.88	$K_s = 0.76$
	FL 1	$\frac{3.18}{1.2}$	= 2.65	$\frac{2.88}{1.2}$	= 2.4	
Masonry requirements	FL 1	20-3.5-L2		20-3.5-L2		

Case 3 Loads and Stresses

Particulars	External Wall		Internal Wall		Remarks
	Individual Load	Progressive Load	Individual Load	Progressive Load	
	kg/m	kg/m	kg/m	kg/m	
(1)	(2)	(3)	(4)	(5)	(6)
Parapet Wall	440	440	—	—	
Roof	600	1 040	1 200	1 200	
Third storey wall	1 250	2 290	1 250	2 450	
Floor 3	550	2 840	1 110	3 560	
Second storey wall	1 250	4 090	1 250	4 810	
Floor 2	550	4 640	1 110	5 920	
First storey wall	1 250	5 890	1 250	7 170	
		kg/cm ²		kg/cm ²	
Compressive stress in masonry wall without openings	<i>FL 3</i>	$\frac{2\ 290}{19 \times 100} = 1.21$		$\frac{2\ 450}{19 \times 100} = 1.29$	
	<i>FL 2</i>	$\frac{4\ 090}{19 \times 100} = 2.15$		$\frac{4\ 810}{19 \times 100} = 2.53$	
	<i>FL 1</i>	$\frac{5\ 890}{19 \times 100} = 3.10$		$\frac{7\ 170}{19 \times 100} = 3.77$	
Compressive stress in masonry wall with openings	<i>FL 3</i>	$\frac{1.21}{0.55} = 2.20$		$\frac{1.29}{0.70} = 1.84$	
	<i>FL 2</i>	$\frac{2.15}{0.55} = 3.91$		$\frac{2.53}{0.70} = 3.61$	
	<i>FL 1</i>	$\frac{3.10}{0.55} = 5.64$		$\frac{3.77}{0.70} = 5.39$	
For Three-Storeyed Building					
Basic stress of requisite masonry without application of shape modification factor	<i>FL 3</i>	$\frac{2.20}{0.86} = 2.56$		$\frac{1.84}{0.86} = 2.14$	$K_s = 0.86$
	<i>FL 2</i>	$\frac{3.91}{0.86} = 4.55$		$\frac{3.61}{0.86} = 4.20$	$K_s = 0.86$
	<i>FL 1</i>	$\frac{5.64}{0.76} = 7.42$		$\frac{5.39}{0.76} = 7.09$	$K_s = 0.76$
Basic stress of requisite masonry after application of shape modification factor	<i>FL 3</i>	$\frac{2.56}{1.2} = 1.1$		$\frac{2.14}{1.2} = 1.8$	
	<i>FL 2</i>	$\frac{4.55}{1.1} = 4.1$		$\frac{4.20}{1.1} = 3.8$	
	<i>FL 1</i>	$\frac{7.42}{1.1} = 6.7$		$\frac{7.09}{1.1} = 6.5$	
Masonry requirements	<i>FL 3</i>	20-3.5-L2		20-3.5-L2	
	<i>FL 2</i>	20-5.0-M3		20-5.0-M3	
	<i>FL 1</i>	20-7.5-M1		20-7.5-M1	

(Continued)

Case 3—Concluded

Particulars		External Wall		Internal Wall		Remarks
<i>For Two-Storeyed Building</i>						
			kg/cm ²		kg/cm ²	
Basic stress of requisite masonry without application of shape modification factor	FL 2	$\frac{2.20}{0.86}$	= 2.56	$\frac{1.84}{0.86}$	= 2.14	$K_s = 0.86$
	FL 1	$\frac{3.91}{0.76}$	= 5.15	$\frac{3.61}{0.76}$	= 4.75	$K_s = 0.76$
Basic stress of requisite masonry after application of shape modification factor	FL 2	$\frac{2.56}{1.2}$	= 2.1	$\frac{2.14}{1.2}$	= 1.8	
	FL 1	$\frac{5.15}{1.1}$	= 4.7	$\frac{4.75}{1.1}$	= 4.3	
Masonry requirements	FL 2	20-3.5-L2		20-3.5-L2		
	FL 1	20-5.0-M1		20-5.0-M2		
<i>For One-Storeyed Building</i>						
Basic stress of requisite masonry without application of shape modification factor	FL 1	$\frac{2.20}{0.76}$	= 2.89	$\frac{1.84}{0.76}$	= 2.42	$K_s = 0.76$
	FL 1	$\frac{2.89}{1.2}$	= 2.4	$\frac{2.42}{1.2}$	= 2.0	
Masonry requirements	FL 1	20-3.5-L2		20-3.5-L2		

Case 4 Loads and Stresses

Particulars (1)	External Wall		Internal Wall		Remarks (6)
	Individual Load	Progressive Load	Individual Load	Progressive Load	
	kg/m (2)	kg/m (3)	kg/m (4)	kg/m (5)	
Parapet Wall	440	440	—	—	
Roof	600	1 040	1 200	1 200	
Third storey wall	1 390	2 430	1 390	2 590	
Floor 3	550	2 980	1 110	3 700	
Second storey wall	1 390	4 370	1 390	5 090	
Floor 2	550	4 920	1 110	6 200	
First storey wall	1 390	6 310	1 390	7 590	
		kg/cm ²		kg/cm ²	
Compressive stress in masonry wall without openings	<i>FL 3</i>	$\frac{2\,430}{19 \times 100} = 1.28$		$\frac{2\,590}{19 \times 100} = 1.36$	
	<i>FL 2</i>	$\frac{4\,370}{19 \times 100} = 2.30$		$\frac{5\,090}{19 \times 100} = 2.68$	
	<i>FL 1</i>	$\frac{6\,310}{19 \times 100} = 3.32$		$\frac{7\,590}{19 \times 100} = 3.99$	
Compressive stress in masonry wall with openings	<i>FL 3</i>	$\frac{1.28}{0.55} = 2.33$		$\frac{1.36}{0.70} = 1.94$	
	<i>FL 2</i>	$\frac{2.30}{0.55} = 4.18$		$\frac{2.68}{0.70} = 3.83$	
	<i>FL 1</i>	$\frac{3.32}{0.55} = 6.04$		$\frac{3.99}{0.70} = 5.70$	
<i>For Three-Storeyed Building</i>					
Basic stress of requisite masonry without application of shape modification factor	<i>FL 3</i>	$\frac{2.33}{0.83} = 2.81$		$\frac{1.94}{0.83} = 2.34$	$K_s = 0.83$
	<i>FL 2</i>	$\frac{4.18}{0.83} = 5.04$		$\frac{3.83}{0.83} = 4.61$	$K_s = 0.83$
	<i>FL 1</i>	$\frac{6.04}{0.73} = 8.27$		$\frac{5.70}{0.73} = 7.81$	$K_s = 0.73$
Basic stress of requisite masonry after application of shape modification factor	<i>FL 3</i>	$\frac{2.81}{1.2} = 2.3$		$\frac{2.34}{1.2} = 2.0$	
	<i>FL 2</i>	$\frac{5.04}{1.1} = 4.6$		$\frac{4.61}{1.1} = 4.2$	
	<i>FL 1</i>	$\frac{8.27}{1.1} = 7.5$		$\frac{7.81}{1.1} = 7.1$	
Masonry requirements	<i>FL 3</i>	20-3.5-L3		20-3.5-L2	
	<i>FL 2</i>	20-5.0-M1		20-5.0-M2	
	<i>FL 1</i>	20-7.5-H1		20-7.5-M1	

(Continued)

Case 4—Concluded

Particulars		External Wall		Internal Wall		Remarks
<i>For Two-Storeyed Building</i>						
			kg/cm ²		kg/cm ²	
Basic stress of requisite masonry without application of shape modification factor	FL 2	$\frac{2.33}{0.83}$	= 2.81	$\frac{1.94}{0.83}$	= 2.34	$K_s = 0.83$
	FL 1	$\frac{4.18}{0.73}$	= 5.73	$\frac{3.83}{0.73}$	= 5.25	$K_s = 0.73$
Basic stress of requisite masonry after application of shape modification factor	FL 2	$\frac{2.81}{1.2}$	= 2.3	$\frac{2.34}{1.2}$	= 1.2	
	FL 1	$\frac{5.73}{1.1}$	= 5.2	$\frac{5.25}{1.1}$	= 4.8	
Masonry requirements	FL 2	20-3.5-L2		20-3.5-L2		
	FL 1	20-7.5-L1		20-5.0-M1		
<i>For One-Storeyed Building</i>						
Basic stress of requisite masonry without application of shape modification factor	FL 1	$\frac{2.33}{0.73}$	= 3.19	$\frac{1.94}{0.73}$	= 2.66	$K_s = 0.73$
Basic stress of requisite masonry after application of shape modification factor	FL 1	$\frac{3.19}{1.2}$	= 2.7	$\frac{2.66}{1.2}$	= 2.2	
Masonry requirements	FL 1	20-3.5-M2		20-3.5-L2		

Case 5 Loads and Stresses

Particulars	External Wall		Internal Wall		Remarks
	Individual Load	Progressive Load	Individual Load	Progressive Load	
(1)	kg/m	kg/m	kg/m	kg/m	(6)
(2)	(3)	(4)	(5)		
Parapet Wall	440	440	—	—	
Roof	830	1 270	1 650	1 650	
Third storey wall	1 260	2 530	1 260	2 910	
Floor 3	720	3 250	1 440	4 350	
Second storey wall	1 260	4 510	1 260	5 610	
Floor 2	720	5 230	1 440	7 050	
First storey wall	1 260	6 490	1 260	8 310	
		kg/cm ²		kg/cm ²	
Compressive stress in masonry wall without openings	FL 3	$\frac{2\,530}{19 \times 100} = 1.33$		$\frac{2\,910}{19 \times 100} = 1.53$	
	FL 2	$\frac{4\,510}{19 \times 100} = 2.37$		$\frac{5\,610}{19 \times 100} = 2.95$	
	FL 1	$\frac{6\,490}{19 \times 100} = 3.42$		$\frac{8\,310}{19 \times 100} = 4.37$	
Compressive stress in masonry wall with openings	FL 3	$\frac{1.33}{0.55} = 2.42$		$\frac{1.53}{0.70} = 2.19$	
	FL 2	$\frac{2.37}{0.55} = 4.31$		$\frac{2.95}{0.70} = 4.21$	
	FL 1	$\frac{3.42}{0.55} = 6.22$		$\frac{4.37}{0.70} = 6.24$	
<i>For Three-Storeyed Building</i>					
Basic stress of requisite masonry without application of shape modification factor	FL 3	$\frac{2.42}{0.86} = 2.81$		$\frac{2.19}{0.86} = 2.55$	$K_s = 0.86$
	FL 2	$\frac{4.31}{0.86} = 5.01$		$\frac{4.21}{0.86} = 4.90$	$K_s = 0.86$
	FL 1	$\frac{6.22}{0.76} = 8.18$		$\frac{6.24}{0.76} = 8.21$	$K_s = 0.76$
Basic stress of requisite masonry after application of shape modification factor	FL 3	$\frac{2.81}{1.2} = 2.3$		$\frac{2.55}{1.2} = 2.1$	
	FL 2	$\frac{5.01}{1.1} = 4.6$		$\frac{4.90}{1.1} = 4.5$	
	FL 1	$\frac{8.18}{1.1} = 7.4$		$\frac{8.21}{1.1} = 7.5$	
Masonry requirements	FL 3	20-3.5-L2		20-3.5-L2	
	FL 2	20-5.0-M1		20-5.0-M1	
	FL 1	20-7.5-M1		20-7.5-H2	

(Continued)

Case 5—Concluded

Particulars		External Wall		Internal Wall		Remarks
<i>For Two-Storeyed Building</i>						
			kg/cm ²		kg/cm ²	
Basic stress of requisite masonry without application of shape modification factor	FL 2	$\frac{2.42}{0.86}$	= 2.81	$\frac{2.19}{0.86}$	= 2.55	$K_s = 0.86$
	FL 1	$\frac{4.31}{0.76}$	= 5.67	$\frac{4.21}{0.76}$	= 5.54	$K_s = 0.76$
Basic stress of requisite masonry after application of shape modification factor	FL 2	$\frac{2.81}{1.2}$	= 2.3	$\frac{2.55}{1.2}$	= 2.1	
	FL 1	$\frac{5.67}{1.1}$	= 5.2	$\frac{5.54}{1.1}$	= 5.0	
Masonry requirements	FL 2	20-3.5-L2		20-3.5-L2		
	FL 1	20-7.5-L1		20-5.0-M1		
<i>For One-Storeyed Building</i>						
Basic stress of requisite masonry without application of shape modification factor	FL 1	$\frac{2.42}{0.76}$	= 3.18	$\frac{2.19}{0.76}$	= 2.88	$K_s = 0.76$
Basic stress of requisite masonry after application of shape modification factor	FL 1	$\frac{3.18}{1.2}$	= 2.7	$\frac{2.88}{1.2}$	= 2.4	
Masonry requirements	FL 1	20-3.5-M2		20-3.5-L2		

Case 6 Loads and Stresses

Particulars (1)	External Wall		Internal Wall		Remarks (6)
	Individual Load	Progressive Load	Individual Load	Progressive Load	
	kg/m (2)	kg/m (3)	kg/m (4)	kg/m (5)	
Parapet Wall	440	440	—	—	
Roof	830	1 270	1 650	1 650	
Third storey wall	1 400	2 670	1 400	3 050	
Floor 3	720	3 390	1 440	4 490	
Second storey wall	1 400	4 790	1 400	5 890	
Floor 2	720	5 510	1 440	7 330	
First storey wall	1 400	6 910	1 400	8 730	
		kg/cm ²		kg/cm ²	
Compressive stress in masonry wall without openings	<i>FL 3</i>	$\frac{2\ 670}{19 \times 100} =$	1.41	$\frac{3\ 050}{19 \times 100} =$	1.61
	<i>FL 2</i>	$\frac{4\ 790}{19 \times 100} =$	2.52	$\frac{5\ 890}{19 \times 100} =$	3.10
	<i>FL 1</i>	$\frac{6\ 910}{19 \times 100} =$	3.64	$\frac{8\ 730}{19 \times 100} =$	4.59
Compressive stress in masonry wall with openings	<i>FL 3</i>	$\frac{1.41}{0.55} =$	2.56	$\frac{1.61}{0.70} =$	2.30
	<i>FL 2</i>	$\frac{2.52}{0.55} =$	4.58	$\frac{3.10}{0.70} =$	4.43
	<i>FL 1</i>	$\frac{3.64}{0.55} =$	6.62	$\frac{4.59}{0.70} =$	6.56
<i>For Three-Storeyed Building</i>					
Basic stress of requisite masonry without application of shape modification factor	<i>FL 3</i>	$\frac{2.56}{0.83} =$	3.08	$\frac{2.30}{0.83} =$	2.77 $K_s = 0.83$
	<i>FL 2</i>	$\frac{4.58}{0.83} =$	5.52	$\frac{4.43}{0.83} =$	5.34 $K_s = 0.83$
	<i>FL 1</i>	$\frac{6.62}{0.73} =$	9.07	$\frac{6.56}{0.73} =$	8.97 $K_s = 0.73$
Basic stress of requisite masonry after application of shape modification factor	<i>FL 3</i>	$\frac{3.08}{1.2} =$	2.6	$\frac{2.77}{1.2} =$	2.3
	<i>FL 2</i>	$\frac{5.52}{1.1} =$	5.0	$\frac{5.34}{1.1} =$	4.9
	<i>FL 1</i>	$\frac{9.07}{1.1} =$	8.25	$\frac{8.97}{1.1} =$	8.2
Masonry requirements	<i>FL 3</i>	20-3.5-M2		20-3.5-M2	
	<i>FL 2</i>	20-5.0-M1		20-5.0-M1	
	<i>FL 1</i>	20-10-M1		20-10-M1	

(Continued)

Case 6—Concluded

Particulars		External Wall		Internal Wall		Remarks
<i>For Two-Storeyed Building</i>						
			kg/cm ²		kg/cm ²	
Basic stress of requisite masonry without application of shape modification factor	FL 2	$\frac{2.56}{0.83}$	= 3.08	$\frac{2.30}{0.83}$	= 2.77	$K_s = 0.83$
	FL 1	$\frac{4.58}{0.73}$	= 6.27	$\frac{4.43}{0.73}$	= 6.07	$K_s = 0.73$
Basic stress of requisite masonry after application of shape modification factor	FL 2	$\frac{3.08}{1.2}$	= 2.6	$\frac{2.77}{1.2}$	= 2.3	
	FL 1	$\frac{6.27}{1.1}$	= 5.7	$\frac{6.07}{1.1}$	= 5.5	
Masonry requirements	FL 2	20-3.5-M2		20-3.5-L2		
	FL 1	20-7.5-M3		20-7.5-M3		
<i>For One-Storeyed Building</i>						
Basic stress of requisite masonry without application of shape modification factor	FL 1	$\frac{2.56}{0.73}$	= 3.51	$\frac{2.30}{0.73}$	= 3.15	$K_s = 0.73$
	FL 1	$\frac{3.51}{1.1}$	= 2.9	$\frac{3.15}{1.2}$	= 2.6	
Masonry requirements	FL 1	20-3.5-M2		20-3.5-M2		

Case 7 Loads and Stresses

Particulars	External Wall		Internal Wall		Remarks
	Individual Load	Progressive Load	Individual Load	Progressive Load	
(1)	kg/m	kg/m	kg/m	kg/m	(6)
(2)	(3)	(4)	(5)		
Parapet Wall	440	440	—	—	
Roof	1 080	1 520	2 170	2 170	
Third storey wall	1 270	2 790	1 270	3 440	
Floor 3	910	3 700	1 810	5 250	
Second storey wall	1 270	4 970	1 270	6 520	
Floor 2	910	5 880	1 810	8 330	
First storey wall	1 270	7 150	1 270	9 600	
		kg/cm ²		kg/cm ²	
Compressive stress in masonry wall without openings	FL 3	$\frac{2\ 790}{19 \times 100} = 1.47$		$\frac{3\ 440}{19 \times 100} = 1.81$	
	FL 2	$\frac{4\ 970}{19 \times 100} = 2.62$		$\frac{6\ 520}{19 \times 100} = 3.43$	
	FL 1	$\frac{7\ 150}{19 \times 100} = 3.76$		$\frac{9\ 600}{19 \times 100} = 5.05$	
Compressive stress in masonry wall with openings	FL 3	$\frac{1.47}{0.55} = 2.67$		$\frac{1.81}{0.70} = 2.59$	
	FL 2	$\frac{2.62}{0.55} = 4.76$		$\frac{3.43}{0.70} = 4.90$	
	FL 1	$\frac{3.76}{0.55} = 6.84$		$\frac{5.05}{0.70} = 7.21$	
<i>For Three-Storeyed Building</i>					
Basic stress of requisite masonry without application of shape modification factor	FL 3	$\frac{2.67}{0.86} = 3.10$		$\frac{2.59}{0.86} = 3.01$	$K_s = 0.86$
	FL 2	$\frac{4.76}{0.86} = 5.53$		$\frac{4.90}{0.86} = 5.70$	$K_s = 0.86$
	FL 1	$\frac{6.84}{0.76} = 9.0$		$\frac{7.21}{0.76} = 9.49$	$K_s = 0.76$
Basic stress of requisite masonry after application of shape modification factor	FL 3	$\frac{3.10}{1.2} = 2.6$		$\frac{3.01}{1.2} = 2.5$	
	FL 2	$\frac{5.53}{1.1} = 5.0$		$\frac{5.70}{1.1} = 5.2$	
	FL 1	$\frac{9.0}{1.1} = 8.2$		$\frac{9.49}{1.1} = 8.6$	
Masonry requirements	FL 3	20-3.5-M2		20-3.5-L2	
	FL 2	20-5.0-M1		20-7.5-L1	
	FL 1	20-10-M1		20-10-M1	

(Continued)

Case 7—Concluded

Particulars		External Wall		Internal Wall		Remarks
<i>For Two-Storeyed Building</i>						
			kg/cm ²		kg/cm ²	
Basic stress of requisite masonry without application of shape modification factor	FL 2	$\frac{2.67}{0.86}$	= 3.10	$\frac{2.59}{0.86}$	= 3.01	$K_s = 0.86$
	FL 1	$\frac{4.76}{0.76}$	= 6.26	$\frac{4.90}{0.76}$	= 6.45	$K_s = 0.76$
Basic stress of requisite masonry after application of shape modification factor	FL 2	$\frac{3.10}{1.2}$	= 2.6	$\frac{3.01}{1.2}$	= 2.5	
	FL 1	$\frac{6.26}{1.1}$	= 5.7	$\frac{6.45}{1.1}$	= 5.9	
Masonry requirements	FL 2	20-3.5-M2		20-3.5-L2		
	FL 1	20-7.5-M2		20-7.5-M2		
<i>For One-Storeyed Building</i>						
Basic stress of requisite masonry without application of shape modification factor	FL 1	$\frac{2.67}{0.76}$	= 3.51	$\frac{2.59}{0.76}$	= 3.40	$K_s = 0.76$
	FL 1	$\frac{3.51}{1.2}$	= 2.9	$\frac{3.40}{1.2}$	= 2.8	
Masonry requirements	FL 1	20-3.5-M2		20-3.5-M2		

Case 8 Loads and Stresses

Particulars (1)	External Wall		Internal Wall		Remarks (6)
	Individual Load	Progressive Load	Individual Load	Progressive Load	
	kg/m	kg/m	kg/m	kg/m	
Parapet wall	440	440	—	—	
Roof	1 080	1 520	2 170	2 170	
Third storey wall	1 400	2 920	1 400	3 570	
Floor 3	910	3 830	1 810	5 380	
Second storey wall	1 400	5 230	1 400	6 780	
Floor 2	910	6 140	1 810	8 590	
First storey wall	1 400	7 540	1 400	9 990	
First storey wall*	2 040	8 180	2 040	10 630	
		kg/cm ²		kg/cm ²	
Compressive stress in masonry wall without openings	FL 3	$\frac{2\,920}{19 \times 100} = 1.54$		$\frac{3\,570}{19 \times 100} = 1.88$	
	FL 2	$\frac{5\,230}{19 \times 100} = 2.75$		$\frac{6\,780}{19 \times 100} = 3.57$	
	FL 1	$\frac{7\,540}{19 \times 100} = 3.97$		$\frac{9\,990}{19 \times 100} = 5.27$	
	FL 1*	$\frac{8\,180}{29 \times 100} = 2.82$		$\frac{10\,630}{29 \times 100} = 3.67$	
Compressive stress in masonry wall with openings	FL 3	$\frac{1.54}{0.55} = 2.80$		$\frac{1.88}{0.70} = 2.69$	
	FL 2	$\frac{2.75}{0.55} = 5.00$		$\frac{3.57}{0.70} = 5.10$	
	FL 1	$\frac{3.97}{0.55} = 7.22$		$\frac{5.26}{0.70} = 7.51$	
	FL 1*	$\frac{2.82}{0.55} = 5.13$		$\frac{3.67}{0.70} = 6.67$	
<i>For Three-Storeyed Building</i>					
Basic stress of requisite masonry without application of shape modification factor	FL 3	$\frac{2.80}{0.83} = 3.37$		$\frac{2.69}{0.83} = 3.24$	$K_s = 0.83$
	FL 2	$\frac{5.00}{0.83} = 6.02$		$\frac{5.10}{0.83} = 6.15$	$K_s = 0.83$
	FL 1	$\frac{7.22}{0.73} = 9.89$		$\frac{7.51}{0.73} = 10.29$	$K_s = 0.73$
	FL 1*	$\frac{5.13}{0.88} = 5.83$		$\frac{6.67}{0.88} = 7.58$	$K_s = 0.88$

(Continued)

Case 8—Concluded

Particulars		External Wall		Internal Wall		Remarks
			kg/cm ²		kg/cm ²	
Basic stress of requisite masonry after application of shape modification factor	FL 3	$\frac{3.37}{1.2}$	= 2.8	$\frac{3.24}{1.2}$	= 2.7	
	FL 2	$\frac{6.02}{1.1}$	= 5.5	$\frac{6.15}{1.1}$	= 5.6	
	FL 1	$\frac{9.89}{1.1}$	= 9.0	$\frac{10.29}{1.1}$	= 9.4	
	FL 1*	$\frac{5.83}{1.1}$	= 5.8	$\frac{7.58}{1.1}$	= 6.9	
Masonry requirements	FL 3	20-3.5-M2		20-3.5-M2		
	FL 2	20-7.5-M3		20-7.5-M3		
	FL 1	20-10-M1		20-10-M1		
	FL 1*	30-7.5-M2		30-7.5-M1		

For Two-Storeyed Building

Basic stress of requisite masonry without application of shape modification factor	FL 2	$\frac{2.80}{0.83}$	= 3.37	$\frac{2.69}{0.83}$	= 3.24	$K_s = 0.83$
	FL 1	$\frac{5.00}{0.73}$	= 6.85	$\frac{5.10}{0.73}$	= 6.99	$K_s = 0.73$
Basic stress of requisite masonry after application of shape modification factor	FL 2	$\frac{3.37}{1.2}$	= 2.8	$\frac{3.24}{1.2}$	= 2.7	
	FL 1	$\frac{6.85}{1.1}$	= 6.2	$\frac{6.99}{1.1}$	= 6.4	
Masonry requirements	FL 2	20-3.5-M2		20-3.5-M1		
	FL 1	20-7.5-M1		20-7.5-M1		

For One-Storeyed Building

Basic stress of requisite masonry without application of shape modification factor	FL 1	$\frac{2.80}{0.73}$	= 3.84	$\frac{2.69}{0.73}$	= 3.68	$K_s = 0.73$
Basic stress of requisite masonry after application of shape modification factor	FL 1	$\frac{3.84}{1.1}$	= 3.5	$\frac{3.68}{1.1}$	= 3.4	
Masonry requirements	FL 1	20-3.5-M2		20-3.5-M2		

*Loads, stresses and masonry requirements for 1½ brick, 30 cm thick wall.

Table E-14 Design Results of Brick Masonry Walls for Residential Building Up to 3 Storeys

Sl No.	Span (m)	Storey Height (m)	Live Load (kg/m)	Storey Level	Three Storeyed Building		Double Storeyed Building		Single Storey Building	
					Internal Wall	External Wall	Internal Wall	External Wall	Internal Wall	External Wall
1.	3.0	2.7	150	FL 3	20-3.5-L2	20-3.5-L2				
				FL 2	20-5.0-M3	20-5.0-M3	20-3.5-L2	20-3.5-L2		
				FL 1	20-7.5-M1	20-7.5-M1	20-5.0-M2	20-5.0-M1	20-3.5-L2	20-3.5-L2
2.	3.6	2.7	150	FL 3	20-3.5-L2	20-3.5-L2				
				FL 2	20-5.0-M2	20-5.0-M2	20-3.5-L2	20-3.5-L2		
				FL 1	20-7.5-M1	20-7.5-M1	20-5.0-M1	20-5.0-M1	20-3.5-L2	20-3.5-L2
3.	3.0	2.7	200	FL 3	20-3.5-L2	20-3.5-L2				
				FL 2	20-5.0-M3	20-5.0-M2	20-3.5-L2	20-3.5-L2		
				FL 1	20-7.5-M1	20-7.5-M1	20-5.0-M2	20-5.0-M1	20-3.5-L2	20-3.5-L2
4.	3.0	3.0	200	FL 3	20-3.5-L2	20-3.5-L2				
				FL 2	20-5.0-M2	20-5.0-M1	20-3.5-L2	20-3.5-L2		
				FL 1	20-7.5-M1	20-7.5-H1	20-5.0-M1	20-7.5-L1	20-3.5-L2	20-3.5-M2
5.	3.6	2.7	200	FL 3	20-3.5-L2	20-3.5-L2				
				FL 2	20-5.0-M1	20-5.0-M1	20-3.5-L2	20-3.5-L2		
				FL 1	20-10-M3	20-7.5-M1	20-5.0-M1	20-7.5-L1	20-3.5-L2	20-3.5-M2
6.	3.6	3.0	200	FL 3	20-3.5-M2	20-3.5-M2				
				FL 2	20-5.0-M1	20-5.0-M1	20-3.5-L2	20-3.5-M2		
				FL 1	20-10-M1	20-10-M1	20-7.5-M3	20-7.5-M3	20-3.5-M2	20-3.5-M2
7.	4.2	2.7	200	FL 3	20-3.5-L2	20-3.5-M2				
				FL 2	20-7.5-L1	20-5.0-M1	20-3.5-L2	20-3.5-M2		
				FL 1	20-10-M1	20-10-M1	20-7.5-M2	20-7.5-M2	20-3.5-M2	20-3.5-M2
8.	4.2	3.0	200	FL 3	20-3.5-M2	20-3.5-M2				
				FL 2	20-7.5-M3	20-7.5-M3	20-3.5-M1	20-3.5-M2		
				FL 1	20-10-M1 or 30-7.5-M2	20-10-M1 or 30-7.5-M2	20-7.5-M1	20-7.5-M1	20-3.5-M2	20-3.5-M2

Table E-15 Design Results of Brick Masonry Walls for Residential Buildings Up to 3 Storeys (Using Conventional Bricks*)

Sl No.	Span (m)	Storey Height (m)	Live Load (kg/m)	Storey Level	Three Storeyed Building		Double Storeyed Building		Single Storey Building	
					Internal Wall	External Wall	Internal Wall	External Wall	Internal Wall	External Wall
(1)	(2)	(3)	(4)	(5)	(6)	(7)	(8)	(9)	(10)	(11)
1.	3.0	2.7	150	FL 3	23-3.5-L2	23-3.5-L2				
				FL 2	23-5.0-L1	23-5.0-M3	23-3.5-L2	23-3.5-L2		
				FL 1	23-7.5-M2	23-7.5-M1	23-5.0-M3	23-5.0-M2	23-3.5-L2	23-3.5-L2
2.	3.6	2.7	150	FL 3	23-3.5-L2	23-3.5-L2				
				FL 2	23-5.0-M3	23-5.0-M2	23-3.5-L2	23-3.5-L2		
				FL 1	23-7.5-M1	23-7.5-M1	23-5.0-M1	23-5.0-M1	23-3.5-L2	23-3.5-M2
3.	3.0	2.7	200	FL 3	23-3.5-L2	23-3.5-L2				
				FL 2	23-5.0-L1	23-5.0-M3	23-3.5-L2	23-3.5-L2		
				FL 1	23-7.5-M2	23-7.5-M1	23-5.0-M3	23-5.0-M1	23-3.5-L2	23-3.5-L2
4.	3.0	3.0	200	FL 3	23-3.5-L2	23-3.5-L2				
				FL 2	23-5.0-M3	23-5.0-M1	23-3.5-L2	23-3.5-L2		
				FL 1	23-7.5-M1	23-7.5-M1	23-5.0-M2	23-5.0-M1	23-3.5-M2	23-3.5-L2
5.	3.6	2.7	200	FL 3	23-3.5-L2	23-3.5-L2				
				FL 2	23-5.0-M2	23-5.0-M2	23-3.5-L2	23-3.5-L2		
				FL 1	23-7.5-M1	23-7.5-M1	23-5.0-M1	23-5.0-M1	23-3.5-L2	23-3.5-M2

(Continued)

Table E-15 — Concluded

(1)	(2)	(3)	(4)	(5)	(6)	(7)	(8)	(9)	(10)	(11)
6.	3.6	3.0	200	FL 3	23-3.5-L2	23-3.5-M1				
				FL 2	23-5.0-M1	23-5.0-M1	23-3.5-L2	23-3.5-M2		
				FL 1	23-7.5-M1	23-10.0-M2	23-5.0-M1	23-7.5-L1	23-3.5-M2	23-3.5-M2
7.	4.2	2.7	200	FL 3	23-3.5-M2	23-3.5-M2				
				FL 2	23-5.0-M1	23-5.0-M1	23-3.5-M2	23-3.5-M2		
				FL 1	23-10-M2	23-10-M2	23-7.5-M1	23-7.5-L1	23-3.5-M2	23-3.5-M2
8.	4.2	3.0	200	FL 3	23-3.5-M2	23-3.5-M2				
				FL 2	23-7.5-L1	23-7.5-L1	23-3.5-M2	23-3.5-M2		
				FL 1	23-10-M1	23-10-M1	23-7.5-M2	23-7.5-M2	23-3.5-M2	23-3.5-M2

*Without giving detailed calculations.

ANNEX H-3

DESIGN OF BRICK MASONRY FOR OFFICE BUILDINGS UP TO 3 STOREYS

H-3.1 Design Parameters

	Maximum Span (Short Span in Case of 2-Way Slab) m	Width of Corridor m	Clear Height of Storey m	Live Load on Floors kg/m ²
Case 1	3.60	1.50	3.00	250
Case 2	3.60	1.50	3.00	400
Case 3	3.60	1.50	3.30	250
Case 4	3.60	1.50	3.30	400
Case 5	4.50	1.80	3.00	250
Case 6	4.50	1.80	3.00	400
Case 7	4.50	1.80	3.30	250
Case 8	4.50	1.80	3.30	400
Case 9	5.40	2.10	3.00	250
Case 10	5.40	2.10	3.00	400
Case 11	5.40	2.10	3.30	250
Case 12	5.40	2.10	3.30	400

H-3.1.1 Typical plan of the office building at all floors has been shown in Fig. E-47.

H-3.2 Assumptions

	For All Cases
H-3.2.1 Height of plinth from ground level	0.5 m
H-3.2.2 Height of plinth above footing top	1.0 m

H-3.2.3 Height of parapet wall above roof slab

	For Cases 1 to 4	For Cases 5 to 8	For Cases 9 to 12
H-3.2.4 Thickness of RCC roof/floor slab	11 cm	14 cm	17 cm

H-3.2.5 Thickness of lime concrete over roof slab (average)

H-3.2.6 Thickness of ceiling finish

H-3.2.7 Thickness of lime concrete cushion under flooring

H-3.2.8 Thickness of cement concrete flooring

H-3.2.9 Wall plastered on both sides, total plaster thickness

H-3.2.10 Length to width ratio, that is, span ratio of rooms

	For All Cases	For Cases 1 to 4	For Cases 5 to 8	For Cases 9 to 12
H-3.2.11 Openings in walls as percentage of wall area in plan:				
a) In wall A (external), percent		50	50	50
b) In wall B, percent		25	20	15
c) In wall C, percent		30	25	20

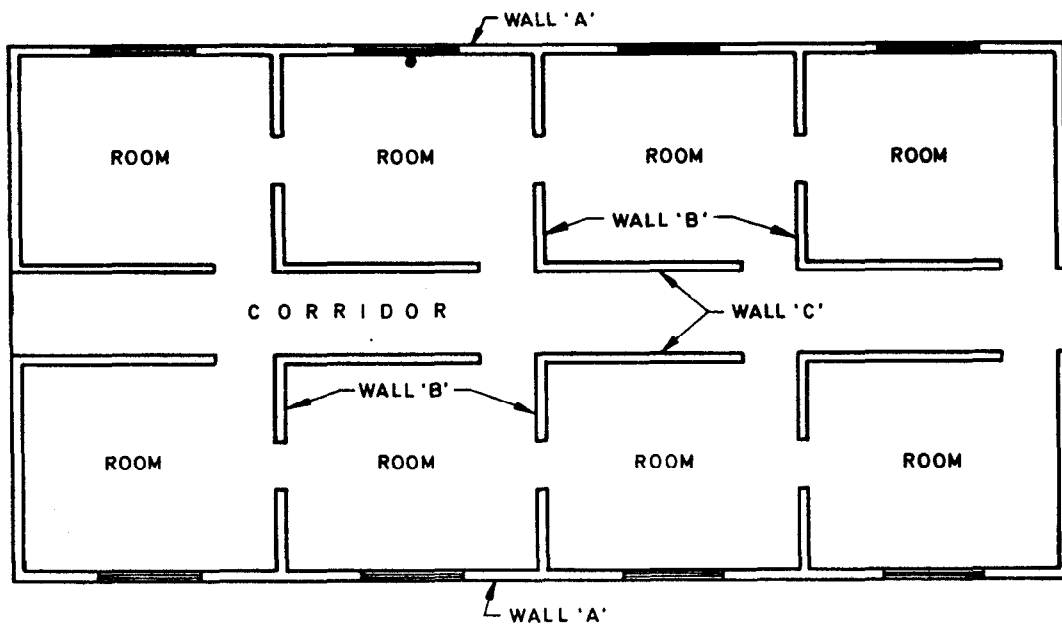

Wall 'A'—External longitudinal wall
 Wall 'B'—Internal cross walls
 Wall 'C'—Internal longitudinal walls

FIG. E-47 TYPICAL PLAN OF OFFICE BUILDING AT ALL FLOORS

H-3.2.12 The bricks used in masonry are modular bricks of nominal size 20 × 10 × 10 cm.

H-3.2.13 Openings in a wall are so shaped and located that:

- in load bearing walls, openings do not occur within $H/8$ distance from a cross wall that provides stiffening to the wall, and length of cross wall is not less than $H/6$ (see 4.6 and Fig. 9 of the Code and also comments on 4.4 of the Code).
- the horizontal area of brickwork in any wall is less than 2 000 cm²; and
- the brickwork between two consecutive openings does not become a column by definition.

NOTE—In case area of brickwork in any wall openings is less than 2 000 cm² or becomes a column by definition, stress in the actual portion shall be checked by calculation.

H-3.2.14 RCC roof/floor bears fully on external masonry walls. So, eccentricity over wall has been assumed to be negligible.

H-3.2.15 The RCC slab is assumed to have been designed as two-way for loading purpose.

H-3.3 Design Steps

H-3.3.1 Slenderness Ratio (SR) and Stress Factor (K_s)

Slenderness ratio and stress factor have been

calculated and are given in Table E-16 for each case (see E-16).

H-3.3.2 Loads

H-3.3.2.1 Unit weights

For calculating the loads of different components of the building, the following unit weights of materials have been taken:

- RCC up to 2 percent steel = 2 500 kg/m³
- Lime concrete = 2 000 kg/m³
- Cement concrete flooring = 2 400 kg/m³
- Brickwork including plaster = 2 000 kg/m³

H-3.3.2.2 Load distribution factors

The RCC slab is assumed as two-way slab for loading purposes. The roof/floor slab loads on the supporting walls have been worked out in accordance with 23.5 and Fig. 6 of IS 456 : 1978.

For assumed span ratios (see H-3.2.10, the load distribution factors have been worked out in accordance with the above referred figure which are as follows:

	For Cases 1 to 4	For Cases 5 to 8	For Cases 9 to 12
--	------------------	------------------	-------------------

- For shorter span 0.60 0.63 0.64
- For longer span 0.40 0.37 0.36

H-3.3.2.3 Unit loads of roof/floor, roof/floor load over different walls, self weight of walls of

Table E-16 Slenderness Ratio and Stress Factors

Particulars	Cases	Cases	Cases	Cases	Cases	Cases
	1 and 2	3 and 4	5 and 6	7 and 8	9 and 10	11 and 12
1. Third and second storey						
a) Actual height H in m (centre to centre of structural slab)	3.24	3.54	3.27	3.57	3.30	3.60
b) Effective height $h = 0.75 H$ from Table 1 of the Code	2.43	2.66	2.45	2.68	2.48	2.70
c) $SR = \frac{h}{t}$ for $t = 19$ cm	12.8	14.0	12.9	14.1	13.0	14.2
d) Stress factor K_s for SR given above in (c) from Table 9 of the Code	0.82	0.78	0.81	0.78	0.81	0.78
2. For first storey						
a) Actual height H in m (from top of footing to the centre of slab)	4.07	4.37	4.08	4.38	4.10	4.40
b) Effective height $h = 0.75 H$ from Table 1 of the Code	3.05	3.28	3.06	3.29	3.08	3.30
c) $SR = \frac{h}{t}$ for $t = 19$ cm	16.1	17.3	16.1	17.3	16.2	17.4
d) Stress factor K_s for SR given above in (c) from Table 9 of the Code	0.73	0.69	0.73	0.69	0.72	0.69
e) $SR = \frac{h}{t}$ for $t = 29$ cm	10.5	11.3	10.6	11.3	10.6	11.4
f) Stress factor K_s for SR given above in (e) from Table 5 of the Code	0.88	0.86	0.88	0.86	0.88	0.86

different thicknesses including parapet walls have been calculated and tabulated in Table E-17.

H-3.3.3 Shape Modification Factor

Assuming that modular brick of size $20 \times 10 \times 10$ cm are used in brick masonry, shape modification factor for bricks of 5.0, 7.5, 10.0 and 15.0

N/mm², strength will be 1.2, 1.1, 1.1 and 1.0 respectively in accordance with Table 8 of the Code. Thus for determining the particulars of masonry required for any situation, values of basic stress as arrived at without application of shape modification factor will be divided by the above factors and values of basic stress thus obtained are taken into consideration.

Table E-17 Unit Loads of Roof/Floor and Walls

Particulars	Loads											
	Case 1	Case 2	Case 3	Case 4	Case 5	Case 6	Case 7	Case 8	Case 9	Case 10	Case 11	Case 12
1. Dead load and live load in kg/m²:												
i) Roof	650	650	650	650	765	765	765	765	880	880	880	880
ii) Room floor	810	960	810	960	885	1035	885	1035	960	1110	960	1110
iii) Corridor floor	1060	1060	1060	1060	1135	1135	1135	1135	1210	1210	1210	1210
2. Roof load on walls in kg/m:												
i) Wall A	610	610	610	610	880	880	880	880	1220	1220	1220	1220
ii) Wall B	1480	1480	1480	1480	2260	2260	2260	2260	3150	3150	3150	3150
iii) Wall C	1160	1160	1160	1160	1640	1640	1640	1640	2230	2230	2230	2230
3. Floor load on walls in kg/m:												
i) Wall A	760	900	760	900	1010	1190	1010	1190	1330	1540	1330	1540
ii) Wall B	1840	2180	1840	2180	2610	3060	2610	3060	3430	3970	3430	3970
iii) Wall C	1660	1800	1660	1800	2140	2310	2140	2310	2710	2920	2710	2920
4. Self weight of wall in kg/m per storey (including 3 cm thick plastering):												
i) For 19 cm thick wall	1430	1430	1560	1560	1440	1440	1570	1570	1450	1450	1580	1580
i) For 29 cm thick wall	1960	1960	2150	2150	1970	1970	2160	2160	1980	1980	2170	2170
5. Self weight of parapet wall (19 cm thick) in kg/m (including 3 cm thick plastering)												
	440	440	440	440	440	440	440	440	440	440	440	440

H-3.3.4 Compressive Stress in Masonry and Particulars of Requisite Masonry

Following steps have been adopted for calculations of loads and stresses for each case which have then been tabulated:

Step (1)—Calculation of loads on external and internal walls taking into account parapet wall load, roof/floor load and self-load of walls.

Step (2)—Working out compressive stress in masonry assuming that there are no openings.

Step (3)—Working out compressive stress after making allowance for openings.

Step (4)—Working out requisite basic stress after applying stress reduction factor but without applying shape modification factor.

Step (5)—Working out values of requisite basic stress after applying shape modification factor.

Step (6)—Determining the masonry requirements for triple, double and single storeyed buildings with reference to Table 8 of the Code.

Important notes in regard to tables for all cases are given below:

- a) Figures have been rounded off suitably to simplify calculations.
- b) The symbols *FL 1*, *FL 2* and *FL 3* have been used to indicate Floor 1 (first floor), Floor 2 (second floor) and Floor 3 (third floor respectively in accordance with IS 2332 : 1972 'Nomenclature of floors and storeys'. Here, the 'floor 1' has been defined as the lowest floor in the building with direct entrance from the road.
- c) For the sake of convenience of reference, the brick masonry requirement has been designated symbolically in the tables. For example, 20-7-M2 means masonry with

20 cm thick wall using bricks with minimum crushing strength of 7 N/mm² and mortar of type M2. Standard Types of mortar have been given for different mix ratios of cement, lime and sand in Table 1 of the Code.

- d) No deductions in self weight of walls due to openings and no reduction in live loads have been made in the calculations since design calculations for masonry cannot be very precise on account of a number of assumptions and thus that refinement is not needed.
- e) In case of first storey, SR applicable to that storey wall is based on height from top of foundations footing to centre of floor slab. Since, we are increasing the stresses due to openings which start from floor 1 level or higher than floor 1 level, we get the maximum stress at floor 1 level. Below that level, as there are no openings, loads on walls will start dispersing and thus in spite of increase in dead load of masonry, no increase in stress will take place below the floor 1 level, unless the percentage of openings taken into consideration is very small. Thus, stresses in case of first storey have been calculated at floor 1 level.
- f) No provision has been made for any wind force in the design calculation, and it has been assumed that the building as a whole is stable against all loads.
- g) No allowance has been made for seismic forces and, therefore, when applying these results for structures in seismic regions other than I and II, strengthening measures as given in IS 4326 : 1976 shall be adopted (see 6.1.2 of the Code).
- h) In marginal cases, actual stress (basic) may exceed the permissible stress by a maximum of 10 percent provided sufficient precautions are taken about the quality of materials and workmanship, and work is done under good technical supervision. Alternatively, percentage of openings in walls may be reduced suitably to bring down the actual stress to permissible limits.

Case 1 Loads and Stresses

Particulars (1)	Wall A		Wall B		Wall C		Remarks (8)
	Individual Load	Progressive Load	Individual Load	Progressive Load	Individual Load	Progressive Load	
	kg/m	kg/m	kg/m	kg/m	kg/m	kg/m	
(2)	(3)	(4)	(5)	(6)	(7)		(8)
Parapet wall	440	440	—	—	—	—	
Roof	610	1 050	1 480	1 480	1 160	1 160	
Third storey wall	1 430	2 480	1 430	2 910	1 430	2 590	
Floor 3	760	3 240	1 840	4 750	1 660	4 250	
Second storey wall	1 430	4 670	1 430	6 180	1 430	5 680	
Floor 2	760	5 430	1 840	8 020	1 660	7 340	
First storey wall	1 430	6 860	1 430	9 450	1 430	8 770	
First storey wall*	1 960	7 390	1 960	9 980	1 960	9 300	
		kg/cm ²		kg/cm ²		kg/cm ²	
Compressive stress in masonry wall without openings	FL 3	$\frac{2\,480}{19 \times 100} = 1.31$		$\frac{2\,910}{19 \times 100} = 1.53$		$\frac{2\,590}{19 \times 100} = 1.36$	
	FL 2	$\frac{4\,670}{19 \times 100} = 2.46$		$\frac{6\,180}{19 \times 100} = 3.25$		$\frac{5\,680}{19 \times 100} = 2.99$	
	FL 1	$\frac{6\,860}{19 \times 100} = 3.61$		$\frac{9\,450}{19 \times 100} = 4.97$		$\frac{8\,770}{19 \times 100} = 4.62$	
	FL 1*	$\frac{7\,390}{29 \times 100} = 2.55$		$\frac{9\,980}{29 \times 100} = 3.44$		$\frac{9\,300}{29 \times 100} = 3.2$	
Compressive stress in masonry wall with openings	FL 3	$\frac{1.31}{0.50} = 2.62$		$\frac{1.53}{0.75} = 2.04$		$\frac{1.36}{0.70} = 1.94$	
	FL 2	$\frac{2.46}{0.50} = 4.92$		$\frac{3.25}{0.75} = 4.33$		$\frac{2.99}{0.70} = 4.27$	
	FL 1	$\frac{3.61}{0.50} = 7.22$		$\frac{4.97}{0.75} = 6.63$		$\frac{4.62}{0.70} = 6.60$	
	FL 1*	$\frac{2.55}{0.50} = 5.10$		$\frac{3.44}{0.75} = 4.59$		$\frac{3.21}{0.70} = 4.59$	
<i>For Three-Storeyed Building</i>							
Basic stress of requisite masonry without application of shape modification factor	FL 3	$\frac{2.62}{0.82} = 3.20$		$\frac{2.04}{0.82} = 2.49$		$\frac{1.94}{0.82} = 2.37$	$K_s = 0.82$
	FL 2	$\frac{4.92}{0.82} = 6.00$		$\frac{4.33}{0.82} = 5.28$		$\frac{4.27}{0.82} = 5.21$	$K_s = 0.82$
	FL 1	$\frac{7.22}{0.73} = 9.89$		$\frac{6.63}{0.73} = 9.08$		$\frac{6.60}{0.73} = 9.04$	$K_s = 0.73$
	FL 1*	$\frac{5.10}{0.88} = 5.80$		$\frac{4.59}{0.88} = 5.20$		$\frac{4.59}{0.88} = 5.22$	$K_s = 0.88$
Basic stress of requisite masonry after application of shape modification factor	FL 3	$\frac{2.62}{1.2} = 2.2$		$\frac{2.49}{1.2} = 2.1$		$\frac{2.37}{1.2} = 2.0$	
	FL 2	$\frac{6.00}{1.1} = 5.5$		$\frac{3.28}{1.1} = 4.8$		$\frac{5.21}{1.1} = 4.7$	
	FL 1	$\frac{9.89}{1.1} = 10.0$		$\frac{9.08}{1.1} = 8.3$		$\frac{9.04}{1.1} = 8.2$	
	FL 1*	$\frac{5.80}{1.1} = 5.3$		$\frac{5.22}{1.1} = 4.8$		$\frac{5.22}{1.1} = 4.8$	

(Continued)

Case 1 — Concluded

Particulars		Wall A	Wall B	Wall C	Remarks
		kg/cm ²	kg/cm ²	kg/cm ²	
Masonry requirements	FL 3	20-3.5-L2	20-3.5-L2	20-3.5-L2	
	FL 2	20-7.5-M3	20-5.0-M1	20-5.0-M2	
	FL 1	20-10-H1	20-10-M2	20-10-M2	
	FL 1*	30-7.5-L1	30-5.0-M1	30-5.0-M1	
<i>For Two-Storeyed Building</i>					
Basic stress of requisite masonry without application of shape modification factor	FL 2	$\frac{2.62}{0.82} = 3.20$	$\frac{2.04}{0.82} = 2.49$	$\frac{1.94}{0.82} = 2.37$	$K_s = 0.82$
	FL 1	$\frac{4.92}{0.73} = 6.74$	$\frac{4.33}{0.73} = 5.93$	$\frac{4.27}{0.73} = 5.85$	$K_s = 0.73$
Basic stress of requisite masonry after application of shape modification factor	FL 2	$\frac{3.20}{1.2} = 2.7$	$\frac{2.49}{1.2} = 2.1$	$\frac{2.37}{1.2} = 2.0$	
	FL 1	$\frac{6.74}{1.1} = 6.1$	$\frac{5.93}{1.1} = 5.4$	$\frac{5.85}{1.1} = 5.3$	
Masonry requirements	FL 2	20-3.5-M2	20-3.5-L2	20-3.5-L2	
	FL 1	20-7.5-M1	20-7.5-M3	20-7.5-L1	
<i>For One-Storeyed Building</i>					
Basic stress of requisite masonry without application of shape modification factor	FL 1	$\frac{2.62}{0.73} = 3.57$	$\frac{2.04}{0.73} = 2.79$	$\frac{1.94}{0.73} = 2.66$	$K_s = 0.73$
Basic stress of requisite masonry after application of shape modification factor	FL 1	$\frac{3.57}{1.1} = 3.3$	$\frac{2.79}{1.1} = 2.5$	$\frac{2.66}{1.2} = 2.2$	
Masonry requirements	FL 1	20-3.5-M2	20-3.5-L2	20-3.5-L2	

*Loads, stresses and masonry requirements for 1½ brick, 30 cm thick wall.

Case 2 Loads and Stresses

Particulars (1)	Wall A		Wall B		Wall C		Remarks (8)
	Individual Load	Progressive Load	Individual Load	Progressive Load	Individual Load	Progressive Load	
	kg/m	kg/m	kg/m	kg/m	kg/m	kg/m	
Parapet wall	440	440	—	—	—	—	
Roof	610	1 050	1 480	1 480	1 160	1 160	
Third storey wall	1 430	2 480	1 430	2 910	1 430	2 590	
Floor 3	900	3 380	2 180	5 090	1 800	4 390	
Second storey wall	1 430	4 810	1 430	6 520	1 430	5 820	
Floor 2	900	5 710	2 180	8 700	1 800	7 620	
First storey wall	1 430	7 140	1 430	10 130	1 430	9 050	
First storey wall*	1 960	7 670	1 960	10 660	1 960	9 580	
		kg/cm ²		kg/cm ²		kg/cm ²	
Compressive stress in masonry wall without openings	FL 3	$\frac{2\ 480}{19 \times 100} = 1.31$		$\frac{2\ 910}{19 \times 100} = 1.53$		$\frac{2\ 590}{19 \times 100} = 1.36$	
	FL 2	$\frac{4\ 810}{19 \times 100} = 2.53$		$\frac{6\ 520}{19 \times 100} = 3.43$		$\frac{5\ 820}{19 \times 100} = 3.06$	
	FL 1	$\frac{7\ 140}{19 \times 100} = 3.76$		$\frac{10\ 130}{19 \times 100} = 5.33$		$\frac{9\ 050}{19 \times 100} = 4.76$	
	FL 1*	$\frac{7\ 670}{29 \times 100} = 2.64$		$\frac{10\ 660}{29 \times 100} = 3.68$		$\frac{9\ 580}{29 \times 100} = 3.30$	
Compressive stress in masonry wall with openings	FL 3	$\frac{1.31}{0.50} = 2.62$		$\frac{1.53}{0.75} = 2.04$		$\frac{1.36}{0.70} = 1.94$	
	FL 2	$\frac{2.53}{0.50} = 5.06$		$\frac{3.43}{0.75} = 4.57$		$\frac{3.06}{0.70} = 4.37$	
	FL 1	$\frac{3.76}{0.50} = 7.52$		$\frac{5.33}{0.75} = 7.11$		$\frac{4.76}{0.70} = 6.80$	
	FL 1*	$\frac{2.64}{0.50} = 5.28$		$\frac{3.68}{0.75} = 4.91$		$\frac{3.30}{0.70} = 4.71$	
<i>For Three-Storeyed Building</i>							
Basic stress of requisite masonry without application of shape modification factor	FL 3	$\frac{2.62}{0.82} = 3.20$		$\frac{2.04}{0.82} = 2.49$		$\frac{1.94}{0.82} = 2.37$	$K_s = 0.82$
	FL 2	$\frac{5.06}{0.82} = 6.17$		$\frac{4.57}{0.82} = 5.57$		$\frac{4.37}{0.82} = 5.33$	$K_s = 0.82$
	FL 1	$\frac{7.52}{0.73} = 10.30$		$\frac{7.11}{0.73} = 9.74$		$\frac{6.80}{0.73} = 9.32$	$K_s = 0.73$
	FL 1*	$\frac{5.28}{0.88} = 6.00$		$\frac{4.91}{0.88} = 5.58$		$\frac{4.71}{0.88} = 5.35$	$K_s = 0.88$
Basic stress of requisite masonry after application of shape modification factor	FL 3	$\frac{3.20}{1.2} = 2.7$		$\frac{2.49}{1.2} = 2.1$		$\frac{2.37}{1.2} = 2.0$	
	FL 2	$\frac{6.17}{1.1} = 5.6$		$\frac{5.57}{1.1} = 5.1$		$\frac{5.33}{1.1} = 4.9$	
	FL 1	$\frac{10.30}{1.0} = 10.3$		$\frac{9.74}{1.1} = 8.9$		$\frac{9.32}{1.1} = 8.5$	
	FL 1*	$\frac{6.00}{1.1} = 5.5$		$\frac{5.58}{1.1} = 5.1$		$\frac{5.35}{1.1} = 4.9$	

(Continued)

Case 2—Concluded

Particulars		Wall A	Wall B	Wall C	Remarks
		kg/cm ²	*kg/cm ²	kg/cm ²	
Masonry requirements	FL 3	20-3.5-M2	20-3.5-L2	20-3.5-L2	
	FL 2	20-7.5-M3	20-5.0-M1	20-5.0-M1	
	FL 1	20-12.5-M1	20-10-M1	20-10-M1	
	FL 1*	30-7.5-M3	30-5.0-M1	30-5.0-M1	
<i>For Two-Storeyed Building</i>					
Basic stress of requisite masonry without application of shape modification factor	FL 2	$\frac{2.62}{0.82} = 3.20$	$\frac{2.04}{0.82} = 2.49$	$\frac{1.94}{0.82} = 2.37$	$K_s = 0.82$
	FL 1	$\frac{5.06}{0.73} = 6.93$	$\frac{4.37}{0.73} = 6.26$	$\frac{4.37}{0.73} = 5.99$	$K_s = 0.73$
Basic stress of requisite masonry after application of shape modification factor	FL 2	$\frac{3.20}{1.2} = 2.7$	$\frac{2.49}{1.2} = 2.1$	$\frac{2.37}{1.2} = 2.0$	
	FL 1	$\frac{6.93}{1.1} = 6.3$	$\frac{6.26}{1.1} = 5.7$	$\frac{5.99}{1.1} = 5.5$	
Masonry requirements	FL 2	20-3.5-M2	20-3.5-L2	20-3.5-L2	
	FL 1	20-7.5-M1	20-7.5-M3	20-7.5-M3	
<i>For One-Storeyed Building</i>					
Basic stress of requisite masonry without application of shape modification factor	FL 1	$\frac{2.62}{0.73} = 3.59$	$\frac{2.04}{0.73} = 2.79$	$\frac{1.94}{0.73} = 2.66$	$K_s = 0.73$
Basic stress of requisite masonry after application of shape modification factor	FL 1	$\frac{3.59}{1.1} = 3.3$	$\frac{2.79}{1.1} = 2.5$	$\frac{2.66}{1.2} = 2.2$	
Masonry requirements	FL 1	20-3.5-M2	20-3.5-L2	20-3.5-L2	

*Loads, stresses and masonry requirements for 1½ brick, 30 cm thick wall.

Case 3 Loads and Stresses

Particulars (1)	Wall A		Wall B		Wall C		Remarks (8)
	Individual Load	Progressive Load	Individual Load	Progressive Load	Individual Load	Progressive Load	
	kg/m	kg/m	kg/m	kg/m	kg/m	kg/m	
	(2)	(3)	(4)	(5)	(6)	(7)	
Parapet wall	440	440	—	—	—	—	
Roof	610	1 050	1 480	1 480	1 160	1 160	
Third storey wall	1 560	2 610	1 560	3 040	1 560	2 720	
Floor 3	760	3 370	1 840	4 880	1 660	4 380	
Second storey wall	1 560	4 930	1 560	6 440	1 560	5 940	
Floor 2	760	5 690	1 840	8 280	1 660	7 600	
First storey wall	1 560	7 250	1 560	9 840	1 560	9 160	
First storey wall*	2 150	7 840	2 150	10 430	2 150	9 750	
		kg/cm ²		kg/cm ²		kg/cm ²	
Compressive stress in masonry wall without openings	FL 3	$\frac{2\ 610}{19 \times 100} = 1.37$		$\frac{3\ 040}{19 \times 100} = 1.60$		$\frac{2\ 720}{19 \times 100} = 1.43$	
	FL 2	$\frac{4\ 930}{19 \times 100} = 2.59$		$\frac{6\ 440}{19 \times 100} = 3.39$		$\frac{5\ 940}{19 \times 100} = 3.13$	
	FL 1	$\frac{7\ 250}{19 \times 100} = 3.82$		$\frac{9\ 840}{19 \times 100} = 5.18$		$\frac{9\ 160}{19 \times 100} = 4.82$	
	FL 1*	$\frac{7\ 840}{29 \times 100} = 2.70$		$\frac{10\ 430}{29 \times 100} = 3.60$		$\frac{9\ 750}{29 \times 100} = 3.36$	
Compressive stress in masonry wall with openings	FL 3	$\frac{1.37}{0.50} = 2.74$		$\frac{1.60}{0.75} = 2.16$		$\frac{1.43}{0.70} = 2.04$	
	FL 2	$\frac{2.59}{0.50} = 5.18$		$\frac{3.39}{0.75} = 4.52$		$\frac{3.13}{0.70} = 4.47$	
	FL 1	$\frac{3.82}{0.50} = 7.64$		$\frac{5.18}{0.75} = 6.91$		$\frac{4.82}{0.70} = 6.89$	
	FL 1*	$\frac{2.70}{0.50} = 5.40$		$\frac{3.60}{0.75} = 4.80$		$\frac{3.36}{0.70} = 4.80$	
<i>For Three-Storeyed Building</i>							
Basic stress of requisite masonry without application of shape modification factor	FL 3	$\frac{2.74}{0.78} = 3.51$		$\frac{2.16}{0.78} = 2.77$		$\frac{2.04}{0.78} = 2.62$	$K_s = 0.78$
	FL 2	$\frac{5.18}{0.78} = 6.64$		$\frac{4.52}{0.78} = 5.79$		$\frac{4.47}{0.78} = 5.73$	$K_s = 0.78$
	FL 1	$\frac{7.64}{0.69} = 11.07$		$\frac{6.91}{0.69} = 10.01$		$\frac{6.89}{0.69} = 9.99$	$K_s = 0.69$
	FL 1*	$\frac{5.40}{0.86} = 6.28$		$\frac{4.80}{0.86} = 5.58$		$\frac{4.80}{0.86} = 5.58$	$K_s = 0.86$
Basic stress of requisite masonry after application of shape modification factor	FL 3	$\frac{3.51}{1.2} = 2.9$		$\frac{2.77}{1.2} = 2.3$		$\frac{2.62}{1.2} = 2.2$	
	FL 2	$\frac{6.67}{1.1} = 6.0$		$\frac{5.79}{1.1} = 5.3$		$\frac{5.73}{1.1} = 5.2$	
	FL 1	$\frac{11.07}{1.0} = 11.1$		$\frac{10.01}{1.0} = 10.0$		$\frac{9.99}{1.0} = 10.0$	
	FL 1*	$\frac{6.28}{1.1} = 5.7$		$\frac{5.58}{1.1} = 5.1$		$\frac{5.58}{1.1} = 5.1$	

(Continued)

Case 3—Concluded

Particulars		Wall A	Wall B	Wall C	Remarks
		kg/cm ²	kg/cm ²	kg/cm ²	
Masonry requirements	FL 3	20-3.5-M2	20-3.5-L2	20-3.5-L2	
	FL 2	20-7.5-M2	20-7.5-L1	20-7.5-L1	
	FL 1	20-12.5-H1	20-10-H1	20-10-H1	
	FL 1*	30-7.5-M2	30-7.5-L1	30-7.5-L1	
<i>For Two-Storeyed Building</i>					
Basic stress of requisite masonry without application of shape modification factor	FL 2	$\frac{2.74}{0.78} = 3.51$	$\frac{2.16}{0.78} = 2.76$	$\frac{2.04}{0.78} = 2.02$	$K_s = 0.78$
	FL 1	$\frac{5.18}{0.69} = 7.51$	$\frac{4.52}{0.69} = 6.55$	$\frac{4.47}{0.69} = 6.48$	$K_s = 0.69$
Basic stress of requisite masonry after application of shape modification factor	FL 2	$\frac{3.51}{1.2} = 2.9$	$\frac{2.76}{1.2} = 2.3$	$\frac{2.62}{1.2} = 2.2$	
	FL 1	$\frac{7.51}{1.1} = 6.8$	$\frac{6.55}{1.1} = 6.0$	$\frac{6.48}{1.1} = 5.9$	
Masonry requirements	FL 2	20-3.5-M2	20-3.5-L2	20-3.5-L2	
	FL 1	20-7.5-M1	20-7.5-M2	20-7.5-M2	
<i>For One-Storeyed Building</i>					
Basic stress of requisite masonry without application of shape modification factor	FL 1	$\frac{2.74}{0.69} = 4.0$	$\frac{2.16}{0.69} = 3.0$	$\frac{2.04}{0.69} = 3.0$	$K_s = 0.69$
Basic stress of requisite masonry after application of shape modification factor	FL 1	$\frac{4.0}{1.1} = 3.6$	$\frac{3.1}{1.2} = 2.6$	$\frac{3.0}{1.2} = 2.5$	
Masonry requirements	FL 1	20-5.0-L1	20-3.5-M2	20-3.5-L2	

*Loads, stresses and masonry requirements for 1½ brick, 30 cm thick wall.

Case 4 Loads and Stresses

Particulars (1)	Wall A		Wall B		Wall C		Remarks (8)
	Individual Load	Progressive Load	Individual Load	Progressive Load	Individual Load	Progressive Load	
	kg/m (2)	kg/m (3)	kg/m (4)	kg/m (5)	kg/m (6)	kg/m (7)	
Parapet wall	440	440	—	—	—	—	
Roof	610	1 050	1 480	1 480	1 160	1 160	
Third storey wall	1 560	2 610	1 560	3 040	1 560	2 720	
Floor 3	900	3 510	2 180	5 220	1 800	4 520	
Second storey wall	1 560	5 070	1 560	6 780	1 560	6 080	
Floor 2	900	5 970	2 180	8 960	1 800	7 880	
First storey wall	1 560	7 530	1 560	10 520	1 560	9 440	
First storey wall*	2 150	8 120	2 150	11 110	2 150	10 030	
		kg/cm ²		kg/cm ²		kg/cm ²	
Compressive stress in masonry wall without openings	FL 3	$\frac{2\ 610}{19 \times 100} = 1.37$	$\frac{3\ 040}{19 \times 100} = 1.60$	$\frac{2\ 720}{19 \times 100} = 1.43$			
	FL 2	$\frac{5\ 070}{19 \times 100} = 2.67$	$\frac{6\ 780}{19 \times 100} = 3.57$	$\frac{6\ 080}{19 \times 100} = 3.20$			
	FL 1	$\frac{7\ 530}{19 \times 100} = 3.96$	$\frac{10\ 520}{19 \times 100} = 5.54$	$\frac{9\ 440}{19 \times 100} = 4.97$			
	FL 1*	$\frac{8\ 120}{29 \times 100} = 2.80$	$\frac{11\ 110}{29 \times 100} = 3.83$	$\frac{10\ 030}{29 \times 100} = 3.46$			
Compressive stress in masonry wall with openings	FL 3	$\frac{1.37}{0.50} = 2.74$	$\frac{1.60}{0.75} = 2.16$	$\frac{1.43}{0.70} = 2.04$			
	FL 2	$\frac{2.67}{0.50} = 5.34$	$\frac{3.57}{0.75} = 4.76$	$\frac{3.20}{0.70} = 4.57$			
	FL 1	$\frac{3.96}{0.50} = 7.92$	$\frac{5.54}{0.75} = 7.39$	$\frac{4.97}{0.70} = 7.10$			
	FL 1*	$\frac{2.80}{0.50} = 5.60$	$\frac{3.83}{0.75} = 5.11$	$\frac{3.46}{0.70} = 4.94$			
<i>For Three-Storeyed Building</i>							
Basic stress of requisite masonry without application of shape modification factor	FL 3	$\frac{2.74}{0.78} = 3.54$	$\frac{2.16}{0.78} = 2.77$	$\frac{2.04}{0.78} = 2.62$	$K_s = 0.78$		
	FL 2	$\frac{5.34}{0.78} = 6.59$	$\frac{4.76}{0.78} = 6.10$	$\frac{4.57}{0.78} = 5.86$	$K_s = 0.78$		
	FL 1	$\frac{7.92}{0.69} = 11.48$	$\frac{7.39}{0.69} = 10.71$	$\frac{7.10}{0.69} = 10.29$	$K_s = 0.69$		
	FL 1*	$\frac{5.60}{0.86} = 6.51$	$\frac{5.11}{0.86} = 5.94$	$\frac{4.94}{0.86} = 5.74$	$K_s = 0.86$		
Basic stress of requisite masonry after application of shape modification factor	FL 3	$\frac{3.54}{1.2} = 2.9$	$\frac{2.77}{1.2} = 2.3$	$\frac{2.62}{1.2} = 2.2$			
	FL 2	$\frac{6.59}{1.1} = 6.0$	$\frac{6.10}{1.1} = 5.5$	$\frac{5.86}{1.1} = 5.3$			
	FL 1	$\frac{11.48}{1.0} = 10.4$	$\frac{10.71}{1.0} = 9.7$	$\frac{10.29}{1.0} = 9.4$			
	FL 1*	$\frac{6.51}{1.1} = 5.9$	$\frac{5.94}{1.1} = 5.4$	$\frac{5.74}{1.1} = 5.2$			

(Continued)

Case 4—Concluded

Particulars		Wall A	Wall B	Wall C	Remarks
		kg/cm ²	kg/cm ²	kg/cm ²	
Masonry requirements	FL 3	20-3.5-M2	20-3.5-L2	20-3.5-L2	
	FL 2	20-7.5-M2	20-7.5-M3	20-7.5-L1	
	FL 1	20-12.5-M1	20-10-M1	20-10-M1	
	FL 1*	30-7.5-M2	30-7.5-M1	30-7.5-L1	
<i>For Two-Storeyed Building</i>					
Basic stress of requisite masonry without application of shape modification factor	FL 2	$\frac{2.74}{0.78} = 3.51$	$\frac{2.16}{0.78} = 2.77$	$\frac{2.04}{0.78} = 2.62$	$K_s = 0.78$
	FL 1	$\frac{5.34}{0.69} = 7.74$	$\frac{4.76}{0.69} = 6.90$	$\frac{4.57}{0.69} = 6.62$	$K_s = 0.69$
Basic stress of requisite masonry after application of shape modification factor	FL 2	$\frac{3.51}{1.2} = 2.9$	$\frac{2.77}{1.2} = 2.3$	$\frac{2.62}{1.2} = 2.2$	
	FL 1	$\frac{7.74}{1.1} = 7.0$	$\frac{6.90}{1.1} = 6.3$	$\frac{6.62}{1.1} = 6.0$	
Masonry requirements	FL 2	20-3.5-M2	20-3.5-L1	20-3.5-L1	
	FL 1	20-7.5-M1	20-7.5-M1	20-7.5-M2	
<i>For One-Storeyed Building</i>					
Basic stress of requisite masonry without application of shape modification factor	FL 1	$\frac{2.74}{0.69} = 3.97$	$\frac{2.16}{0.69} = 3.13$	$\frac{2.04}{0.69} = 2.96$	$K_s = 0.69$
	FL 1	$\frac{3.97}{1.1} = 3.6$	$\frac{3.13}{1.2} = 2.6$	$\frac{2.96}{1.2} = 2.5$	
Masonry requirements	FL 1	20-5-L1	20-3.5-M2	20-3.5-L2	

*Loads, stresses and masonry requirements for 1½ brick, 30 cm thick wall.

Case 5 Loads and Stresses

Particulars (1)	Wall A		Wall B		Wall C		Remarks (8)
	Individual Load	Progressive Load	Individual Load	Progressive Load	Individual Load	Progressive Load	
	kg/m	kg/m	kg/m	kg/m	kg/m	kg/m	
(2)	(3)	(4)	(5)	(6)	(7)		
Parapet wall	440	440	—	—	—	—	
Roof	880	1 320	2 260	2 260	1 640	1 640	
Third storey wall	1 440	2 760	1 440	3 700	1 440	3 080	
Floor 3	1 010	3 770	2 610	6 310	2 140	5 220	
Second storey wall	1 440	5 210	1 440	7 750	1 440	6 660	
Floor 2	1 010	6 220	2 610	10 360	2 140	8 800	
First storey wall	1 440	7 660	1 440	1 800	1 440	10 240	
First storey wall*	1 970	8 190	1 970	12 330	1 970	10 770	
		kg/cm ²		kg/cm ²		kg/cm ²	
Compressive stress in masonry wall without openings	FL 3	$\frac{2\ 760}{19 \times 100} = 1.45$	$\frac{3\ 700}{19 \times 100} = 1.95$	$\frac{3\ 700}{19 \times 100} = 1.95$	$\frac{3\ 080}{19 \times 100} = 1.62$	$\frac{3\ 080}{19 \times 100} = 1.62$	
	FL 2	$\frac{5\ 210}{19 \times 100} = 2.74$	$\frac{7\ 750}{19 \times 100} = 4.08$	$\frac{7\ 750}{19 \times 100} = 4.08$	$\frac{6\ 660}{19 \times 100} = 3.51$	$\frac{6\ 660}{19 \times 100} = 3.51$	
	FL 1	$\frac{7\ 660}{19 \times 100} = 4.03$	$\frac{11\ 800}{19 \times 100} = 6.21$	$\frac{11\ 800}{19 \times 100} = 6.21$	$\frac{10\ 240}{19 \times 100} = 5.39$	$\frac{10\ 240}{19 \times 100} = 5.39$	
	FL 1*	$\frac{8\ 190}{29 \times 100} = 2.82$	$\frac{12\ 330}{29 \times 100} = 4.25$	$\frac{12\ 330}{29 \times 100} = 4.25$	$\frac{10\ 770}{29 \times 100} = 3.71$	$\frac{10\ 770}{29 \times 100} = 3.71$	
Compressive stress in masonry wall with openings	FL 3	$\frac{1.45}{0.50} = 2.90$	$\frac{1.95}{0.80} = 2.44$	$\frac{1.95}{0.80} = 2.44$	$\frac{1.62}{0.75} = 2.16$	$\frac{1.62}{0.75} = 2.16$	
	FL 2	$\frac{2.74}{0.50} = 5.48$	$\frac{4.08}{0.80} = 5.10$	$\frac{4.08}{0.80} = 5.10$	$\frac{3.51}{0.75} = 4.68$	$\frac{3.51}{0.75} = 4.68$	
	FL 1	$\frac{4.03}{0.50} = 8.06$	$\frac{6.21}{0.80} = 7.76$	$\frac{6.21}{0.80} = 7.76$	$\frac{5.39}{0.75} = 7.19$	$\frac{5.39}{0.75} = 7.19$	
	FL 1*	$\frac{2.82}{0.50} = 5.64$	$\frac{4.25}{0.80} = 5.31$	$\frac{4.25}{0.80} = 5.31$	$\frac{3.71}{0.75} = 4.95$	$\frac{3.71}{0.75} = 4.95$	
<i>For Three-Storeyed Building</i>							
Basic stress of requisite masonry without application of shape modification factor	FL 3	$\frac{2.90}{0.81} = 3.58$	$\frac{2.44}{0.81} = 3.01$	$\frac{2.44}{0.81} = 3.01$	$\frac{2.16}{0.81} = 2.67$	$\frac{2.16}{0.81} = 2.67$	$K_s = 0.81$
	FL 2	$\frac{5.48}{0.81} = 6.77$	$\frac{5.10}{0.81} = 6.30$	$\frac{5.10}{0.81} = 6.30$	$\frac{4.68}{0.81} = 5.78$	$\frac{4.68}{0.81} = 5.78$	$K_s = 0.81$
	FL 1	$\frac{8.06}{0.73} = 11.04$	$\frac{7.76}{0.73} = 10.63$	$\frac{7.76}{0.73} = 10.63$	$\frac{7.19}{0.73} = 9.85$	$\frac{7.19}{0.73} = 9.85$	$K_s = 0.73$
	FL 1*	$\frac{5.64}{0.88} = 6.41$	$\frac{5.31}{0.88} = 6.03$	$\frac{5.31}{0.88} = 6.03$	$\frac{4.94}{0.88} = 5.62$	$\frac{4.94}{0.88} = 5.62$	$K_s = 0.88$
Basic stress of requisite masonry after application of shape modification factor	FL 3	$\frac{0.58}{1.2} = 3.0$	$\frac{3.01}{1.2} = 2.5$	$\frac{3.01}{1.2} = 2.5$	$\frac{2.67}{1.2} = 2.2$	$\frac{2.67}{1.2} = 2.2$	
	FL 2	$\frac{6.77}{1.1} = 6.2$	$\frac{6.30}{1.1} = 5.7$	$\frac{6.30}{1.1} = 5.7$	$\frac{5.78}{1.1} = 5.3$	$\frac{5.78}{1.1} = 5.3$	
	FL 1	$\frac{11.04}{1.0} = 11.0$	$\frac{10.63}{1.0} = 10.6$	$\frac{10.63}{1.0} = 10.6$	$\frac{9.85}{1.1} = 9.0$	$\frac{9.85}{1.1} = 9.0$	
	FL 1*	$\frac{6.41}{1.1} = 5.8$	$\frac{6.03}{1.1} = 5.5$	$\frac{6.03}{1.1} = 5.5$	$\frac{5.62}{1.1} = 5.1$	$\frac{5.62}{1.1} = 5.1$	

(Continued)

Case 5—Concluded

Particulars		Wall A	Wall B	Wall C	Remarks
		kg/cm ²	kg/cm ²	kg/cm ²	
Masonry requirements	FL 3	20-3.5-M2	20-3.5-L2	20-3.5-L2	
	FL 2	20-7.5-M1	20-7.5-M3	20-7.5-L1	
	FL 1	20-12.5-H2	20-12.5-M1	20-10-M1	
	FL 1*	30-7.5-M2	30-7.5-M3	30-7.5-L1	

For Two-Storeyed Building

Basic stress of requisite masonry without application of shape modification factor	FL 2	$\frac{2.90}{0.81} = 3.58$	$\frac{2.44}{0.81} = 3.01$	$\frac{2.16}{0.81} = 2.67$	$K_s = 0.81$
	FL 1	$\frac{5.48}{0.73} = 7.51$	$\frac{5.10}{0.73} = 7.0$	$\frac{4.68}{0.73} = 6.41$	$K_s = 0.73$
Basic stress of requisite masonry after application of shape modification factor	FL 2	$\frac{3.58}{1.2} = 3.0$	$\frac{3.01}{1.2} = 2.5$	$\frac{2.67}{1.2} = 2.2$	
	FL 1	$\frac{7.51}{1.1} = 6.8$	$\frac{7.0}{1.1} = 6.4$	$\frac{6.41}{1.1} = 5.8$	
Masonry requirements	FL 2	20-3.5-M2	20-3.5-L2	20-3.5-L2	
	FL 1	20-7.5-M1	20-7.5-M1	20-7.5-M2	

For One-Storeyed Building

Basic stress of requisite masonry without application of shape modification factor	FL 1	$\frac{2.90}{0.73} = 3.97$	$\frac{2.44}{0.73} = 3.34$	$\frac{2.16}{0.73} = 2.96$	$K_s = 0.73$
Basic stress of requisite masonry after application of shape modification factor	FL 1	$\frac{3.97}{1.1} = 3.6$	$\frac{3.34}{1.2} = 2.8$	$\frac{2.96}{1.2} = 2.5$	
Masonry requirements	FL 1	20-5-L1	20-3.5-M2	20-3.5-L2	

*Loads, stresses and masonry requirements for 1½ brick, 30 cm thick wall.

Case 6 Loads and Stresses

Particulars (1)	Wall A		Wall B		Wall C		Remarks (8)
	Individual Load	Progressive Load	Individual Load	Progressive Load	Individual Load	Progressive Load	
	kg/m	kg/m	kg/m	kg/m	kg/m	kg/m	
Parapet wall	440	440	—	—	—	—	
Roof	880	1 320	2 260	2 260	1 640	1 640	
Third storey wall	1 440	2 760	1 440	3 700	1 440	3 080	
Floor 3	1 190	3 950	3 060	6 760	2 310	5 390	
Second storey wall	1 440	5 390	1 440	8 200	1 440	6 830	
Floor 2	1 190	6 580	3 060	11 260	2 310	9 140	
First storey wall	1 440	8 020	1 440	12 700	1 440	10 580	
First storey wall*	1 970	8 550	1 970	13 230	1 970	11 110	
		kg/cm ²		kg/cm ²		kg/cm ²	
Compressive stress in masonry wall without openings	FL 3	$\frac{2\ 760}{19 \times 100} = 1.45$		$\frac{3\ 700}{19 \times 100} = 1.95$		$\frac{3\ 080}{19 \times 100} = 1.62$	
	FL 2	$\frac{5\ 390}{19 \times 100} = 2.84$		$\frac{8\ 200}{19 \times 100} = 4.32$		$\frac{6\ 830}{19 \times 100} = 3.59$	
	FL 1	$\frac{8\ 020}{19 \times 100} = 4.22$		$\frac{12\ 700}{19 \times 100} = 6.68$		$\frac{10\ 580}{19 \times 100} = 5.57$	
	FL 1*	$\frac{8\ 550}{29 \times 100} = 2.95$		$\frac{13\ 230}{29 \times 100} = 4.56$		$\frac{11\ 110}{29 \times 100} = 3.83$	
Compressive stress in masonry wall with openings	FL 3	$\frac{1.45}{0.50} = 2.90$		$\frac{1.95}{0.80} = 2.44$		$\frac{1.62}{0.75} = 2.16$	
	FL 2	$\frac{2.84}{0.50} = 5.68$		$\frac{4.32}{0.80} = 5.40$		$\frac{3.59}{0.75} = 4.79$	
	FL 1	$\frac{4.22}{0.50} = 8.44$		$\frac{6.68}{0.80} = 8.35$		$\frac{5.57}{0.75} = 7.43$	
	FL 1*	$\frac{2.95}{0.50} = 5.90$		$\frac{4.56}{0.80} = 5.70$		$\frac{3.83}{0.75} = 5.11$	
<i>For Three-Storeyed Building</i>							
Basic stress of requisite masonry without application of shape modification factor	FL 3	$\frac{2.90}{0.81} = 3.58$		$\frac{2.44}{0.81} = 3.01$		$\frac{2.16}{0.81} = 2.67$	$K_s = 0.81$
	FL 2	$\frac{5.68}{0.81} = 7.01$		$\frac{5.40}{0.81} = 6.67$		$\frac{4.79}{0.81} = 5.91$	$K_s = 0.81$
	FL 1	$\frac{8.44}{0.73} = 11.56$		$\frac{8.35}{0.73} = 11.44$		$\frac{7.43}{0.73} = 10.18$	$K_s = 0.73$
	FL 1*	$\frac{5.90}{0.88} = 6.70$		$\frac{5.70}{0.88} = 6.48$		$\frac{5.11}{0.88} = 5.81$	$K_s = 0.88$
Basic stress of requisite masonry after application of shape modification factor	FL 3	$\frac{3.58}{1.2} = 3.0$		$\frac{3.01}{1.2} = 2.5$		$\frac{2.67}{1.2} = 2.2$	
	FL 2	$\frac{7.01}{1.1} = 6.4$		$\frac{6.67}{1.1} = 6.1$		$\frac{5.91}{1.1} = 5.4$	
	FL 1	$\frac{11.56}{1.0} = 11.6$		$\frac{11.44}{1.0} = 11.4$		$\frac{10.18}{1.0} = 10.2$	
	FL 1*	$\frac{6.70}{1.1} = 6.1$		$\frac{6.48}{1.1} = 5.9$		$\frac{5.81}{1.1} = 5.3$	

(Continued)

Case 6—Concluded

Particulars		Wall A	Wall B	Wall C	Remarks
		kg/cm ²	kg/cm ²	kg/cm ²	
Masonry requirements	FL 3	20-3.5-M2	20-3.5-L2	20-3.5-L2	
	FL 2	20-7.5-M1	20-7.5-M1	20-7.5-L1	
	FL 1	20-12.5-H1	20-12.5-H1	20-12.5-H1	
	FL 1*	30-7.5-M1	30-7.5-M2	30-7.5-L1	
<i>For Two-Storeyed Building</i>					
Basic stress of requisite masonry without application of shape modification factor	FL 2	$\frac{2.90}{0.81} = 3.58$	$\frac{2.44}{0.81} = 3.01$	$\frac{2.16}{0.81} = 2.67$	$K_s = 0.81$
	FL 1	$\frac{5.68}{0.73} = 7.78$	$\frac{5.40}{0.73} = 7.40$	$\frac{4.79}{0.73} = 6.56$	$K_s = 0.73$
Basic stress of requisite masonry after application of shape modification factor	FL 2	$\frac{3.58}{1.2} = 3.0$	$\frac{3.01}{1.2} = 2.5$	$\frac{2.67}{1.2} = 2.2$	
	FL 1	$\frac{7.78}{1.1} = 7.1$	$\frac{7.40}{1.1} = 6.7$	$\frac{6.56}{1.1} = 6.0$	
Masonry requirements	FL 2	20-3.5-M2	20-3.5-L2	20-3.5-L2	
	FL 1	20-7.5-M1	20-7.5-M1	20-7.5-M2	
<i>For One-Storeyed Building</i>					
Basic stress of requisite masonry without application of shape modification factor	FL 1	$\frac{2.90}{0.73} = 3.97$	$\frac{2.44}{0.73} = 3.34$	$\frac{2.16}{0.73} = 2.96$	$K_s = 0.73$
Basic stress of requisite masonry after application of shape modification factor	FL 1	$\frac{3.97}{1.1} = 3.6$	$\frac{3.34}{1.2} = 2.8$	$\frac{2.96}{1.2} = 2.5$	
Masonry requirements	FL 1	20-5.0-L1	20-3.5-M2	20-3.5-L2	

*Loads, stresses and masonry requirements for 1½ brick, 30 cm thick wall.

Case 7 Loads and Stresses

Particulars	Wall A		Wall B		Wall C		Remarks
	Individual Load	Progressive Load	Individual Load	Progressive Load	Individual Load	Progressive Load	
	kg/m	kg/m	kg/m	kg/m	kg/m	kg/m	
(1)	(2)	(3)	(4)	(5)	(6)	(7)	(8)
Parapet wall	440	440	—	—	—	—	
Roof	880	1 320	2 260	1 640	1 640	1 640	
Third storey wall	1 570	2 890	1 570	3 830	1 570	3 210	
Floor 3	1 010	3 900	2 610	6 440	2 140	5 350	
Second storey wall	1 570	5 470	1 570	8 010	1 570	6 920	
Floor 2	1 010	6 480	2 610	10 620	2 140	9 060	
First storey wall	1 570	8 050	1 570	12 190	1 570	10 630	
First storey wall*	2 160	8 640	2 160	12 780	2 160	11 220	
		kg/cm ²		kg/cm ²		kg/cm ²	
Compressive stress in masonry wall without openings	FL 3	$\frac{2\ 890}{19 \times 100} = 1.52$		$\frac{3\ 830}{19 \times 100} = 2.02$		$\frac{3\ 210}{19 \times 100} = 1.69$	
	FL 2	$\frac{5\ 470}{19 \times 100} = 2.88$		$\frac{8\ 010}{19 \times 100} = 4.22$		$\frac{6\ 920}{19 \times 100} = 3.64$	
	FL 1	$\frac{8\ 050}{19 \times 100} = 4.24$		$\frac{12\ 190}{19 \times 100} = 6.42$		$\frac{10\ 630}{19 \times 100} = 5.59$	
	FL 1*	$\frac{8\ 640}{29 \times 100} = 2.98$		$\frac{12\ 780}{29 \times 100} = 4.41$		$\frac{11\ 220}{29 \times 100} = 3.87$	
Compressive stress in masonry wall with openings	FL 3	$\frac{1.52}{0.50} = 3.04$		$\frac{2.02}{0.80} = 2.53$		$\frac{1.69}{0.75} = 2.25$	
	FL 2	$\frac{2.88}{0.50} = 5.76$		$\frac{4.22}{0.80} = 5.28$		$\frac{3.64}{0.75} = 4.85$	
	FL 1	$\frac{4.24}{0.50} = 8.48$		$\frac{6.42}{0.80} = 8.03$		$\frac{5.59}{0.75} = 7.45$	
	FL 1*	$\frac{2.98}{0.50} = 5.96$		$\frac{4.41}{0.80} = 5.51$		$\frac{3.87}{0.75} = 5.16$	
<i>For Three-Storeyed Building</i>							
Basic stress of requisite masonry without application of shape modification factor	FL 3	$\frac{3.04}{0.78} = 3.89$		$\frac{2.53}{0.78} = 3.24$		$\frac{2.25}{0.78} = 2.88$	$K_s = 0.78$
	FL 2	$\frac{5.76}{0.78} = 7.38$		$\frac{5.28}{0.78} = 6.77$		$\frac{4.85}{0.78} = 6.22$	$K_s = 0.78$
	FL 1	$\frac{8.48}{0.69} = 12.29$		$\frac{8.03}{0.69} = 11.64$		$\frac{7.45}{0.69} = 10.80$	$K_s = 0.69$
	FL 1*	$\frac{5.96}{0.86} = 6.93$		$\frac{5.51}{0.86} = 6.41$		$\frac{5.16}{0.86} = 6.0$	$K_s = 0.86$
Basic stress of requisite masonry after application of shape modification factor	FL 3	$\frac{3.89}{1.2} = 3.24$		$\frac{3.24}{1.2} = 2.7$		$\frac{2.88}{1.2} = 2.4$	
	FL 2	$\frac{7.38}{1.1} = 6.7$		$\frac{6.77}{1.1} = 6.2$		$\frac{6.22}{1.1} = 5.7$	
	FL 1	$\frac{12.29}{1.0} = 12.3$		$\frac{11.64}{1.0} = 11.6$		$\frac{10.80}{1.0} = 10.8$	
	FL 1*	$\frac{6.93}{1.1} = 6.3$		$\frac{6.41}{1.1} = 5.8$		$\frac{6.0}{1.1} = 5.5$	

(Continued)

Case 7—Concluded

Particulars		Wall A		Wall B		Wall C	Remarks
		kg/cm ²		kg/cm ²		kg/cm ²	
Masonry requirements	FL 3	20-3.5-L1		20-3.5-M2		20-3.5-L2	
	FL 2	20-7.5-M1		20-7.5-M3		20-7.5-M2	
	FL 1	20-15-H1		20-12.5-H1		20-12.5-M1	
	FL 1*	30-7.5-M1		30-7.5-M2		30-7.5-M3	
<i>For Two-Storeyed Building</i>							
Basic stress of requisite masonry without application of shape modification factor	FL 2	$\frac{3.04}{0.78}$	= 3.90	$\frac{2.53}{0.78}$	= 3.24	$\frac{2.25}{0.78}$	= 2.88 $K_s = 0.78$
	FL 1	$\frac{5.76}{0.69}$	= 8.35	$\frac{5.28}{0.69}$	= 7.65	$\frac{4.85}{0.69}$	= 7.03 $K_s = 0.69$
Basic stress of requisite masonry after application of shape modification factor	FL 2	$\frac{3.90}{1.2}$	= 3.25	$\frac{3.24}{1.2}$	= 2.7	$\frac{2.88}{1.2}$	= 2.4
	FL 1	$\frac{8.35}{1.1}$	= 7.6	$\frac{7.65}{1.1}$	= 7.0	$\frac{7.03}{1.1}$	= 6.4
Masonry requirements	FL 2	20-3.5-M2		20-3.5-M2		20-3.5-L2	
	FL 1	20-7.5-H1		20-7.5-M1		20-7.5-M1	
<i>For One-Storeyed Building</i>							
Basic stress of requisite masonry without application of shape modification factor	FL 1	$\frac{3.04}{0.63}$	= 4.41	$\frac{2.53}{0.69}$	= 3.67	$\frac{2.25}{0.69}$	= 3.26 $K_s = 0.69$
Basic stress of requisite masonry after application of shape modification factor	FL 1	$\frac{4.41}{1.2}$	= 3.63	$\frac{3.67}{1.2}$	= 3.06	$\frac{3.26}{1.1}$	= 2.72
Masonry requirements	FL 1	20-5.0-M3		20-3.5-M2		20-3.5-M2	

*Loads, stresses and masonry requirements for 1½ brick, 30 cm thick wall.

Case 8 Loads and Stresses

Particulars (1)	Wall A		Wall B		Wall C		Remarks (8)
	Individual Load	Progressive Load	Individual Load	Progressive Load	Individual Load	Progressive Load	
	kg/m (2)	kg/m (3)	kg/m (4)	kg/m (5)	kg/m (6)	kg/m (7)	
Parapet wall	440	440	—	—	—	—	
Roof	880	1 320	2 260	2 260	1 640	1 640	
Third storey wall	1 570	2 890	1 570	3 830	1 570	3 210	
Floor 3	1 190	4 080	4 060	6 890	2 310	5 520	
Second storey wall	1 570	5 650	1 570	8 460	1 570	7 090	
Floor 2	1 190	6 840	3 060	11 520	2 310	9 400	
First storey wall	1 570	8 410	1 570	13 090	1 570	10 970	
First storey wall*	2 160	9 000	2 160	13 680	2 160	11 560	
		kg/cm ²		kg/cm ²		kg/cm ²	
Compressive stress in masonry wall without openings	FL 3	$\frac{2\ 890}{19 \times 100} = 1.52$	$\frac{3\ 830}{19 \times 100} = 2.02$	$\frac{3\ 210}{19 \times 100} = 1.69$			
	FL 2	$\frac{5\ 650}{19 \times 100} = 2.97$	$\frac{8\ 460}{19 \times 100} = 4.45$	$\frac{7\ 090}{19 \times 100} = 3.73$			
	FL 1	$\frac{8\ 410}{19 \times 100} = 4.43$	$\frac{13\ 090}{19 \times 100} = 6.89$	$\frac{10\ 970}{19 \times 100} = 5.77$			
	FL 1*	$\frac{9\ 000}{29 \times 100} = 3.10$	$\frac{13\ 680}{29 \times 100} = 4.72$	$\frac{11\ 560}{29 \times 100} = 3.99$			
Compressive stress in masonry wall with openings	FL 3	$\frac{1.52}{0.50} = 30.4$	$\frac{2.02}{0.80} = 2.53$	$\frac{1.69}{0.75} = 2.25$			
	FL 2	$\frac{2.97}{0.50} = 5.94$	$\frac{4.45}{0.80} = 5.56$	$\frac{3.73}{0.75} = 4.97$			
	FL 1	$\frac{4.43}{0.50} = 8.86$	$\frac{6.89}{0.80} = 8.61$	$\frac{5.77}{0.75} = 7.69$			
	FL 1*	$\frac{3.10}{0.50} = 6.20$	$\frac{4.72}{0.80} = 5.90$	$\frac{3.99}{0.75} = 5.32$			
<i>For Three-Storeyed Building</i>							
Basic stress of requisite masonry without application of shape modification factor	FL 3	$\frac{3.04}{0.78} = 3.90$	$\frac{2.53}{0.78} = 3.24$	$\frac{2.25}{0.78} = 2.88$	$K_s = 0.78$		
	FL 2	$\frac{5.94}{0.78} = 7.62$	$\frac{5.56}{0.78} = 7.13$	$\frac{4.97}{0.78} = 6.37$	$K_s = 0.78$		
	FL 1	$\frac{8.86}{0.69} = 12.84$	$\frac{8.61}{0.69} = 12.45$	$\frac{7.69}{0.69} = 11.14$	$K_s = 0.69$		
	FL 1*	$\frac{6.20}{0.86} = 7.21$	$\frac{5.90}{0.86} = 6.86$	$\frac{5.32}{0.86} = 6.19$	$K_s = 0.86$		
Basic stress of requisite masonry after application of shape modification factor	FL 3	$\frac{3.40}{1.2} = 3.35$	$\frac{3.24}{1.2} = 2.7$	$\frac{2.83}{1.2} = 2.4$			
	FL 2	$\frac{7.62}{1.1} = 6.9$	$\frac{7.13}{1.1} = 6.5$	$\frac{6.37}{1.1} = 5.8$			
	FL 1	$\frac{12.84}{1.0} = 12.8$	$\frac{12.45}{1.0} = 12.5$	$\frac{11.14}{1.0} = 11.1$			
	FL 1*	$\frac{7.21}{1.1} = 6.6$	$\frac{0.86}{1.1} = 6.2$	$\frac{6.19}{1.1} = 5.6$			

(Continued)

Case 8—Concluded

Particulars		Wall A		Wall B		Wall C	Remarks
		kg/cm ²		kg/cm ²		kg/cm ²	
Masonry requirements	FL 3	20-3.5-M2		20-3.5-M2		20-3.5-L2	
	FL 2	20-7.5-M1		20-7.5-M1		20-7.5-M2	
	FL 1	20-15.0-H1		20-15.0-H1		20-12.5-H2	
	FL 1*	30-7.5-M1		30-7.5-M1		30-7.5-M3	

For Two-Storeyed Building

Basic stress of requisite masonry without application of shape modification factor	FL 2	$\frac{3.04}{0.78} = 3.89$		$\frac{2.53}{0.78} = 3.24$		$\frac{2.25}{0.78} = 2.88$	$K_s = 0.78$
	FL 1	$\frac{5.94}{0.69} = 8.61$		$\frac{5.56}{0.69} = 8.06$		$\frac{4.97}{0.69} = 7.20$	$K_s = 0.69$
Basic stress of requisite masonry after application of shape modification factor	FL 2	$\frac{3.40}{1.1} = 3.25$		$\frac{2.24}{1.2} = 2.7$		$\frac{2.28}{1.2} = 2.4$	
	FL 1	$\frac{8.61}{1.1} = 7.8$		$\frac{8.06}{1.1} = 7.3$		$\frac{7.20}{1.1} = 6.5$	
Masonry requirements	FL 2	20-3.5-M2		20-3.5-M2		20-3.5-L2	
	FL 1	20-10-M2		20-7.5-M1		20-7.5-M1	

For One-Storeyed Building

Basic stress of requisite masonry without application of shape modification factor	FL 1	$\frac{3.04}{0.69} = 4.41$		$\frac{2.53}{0.69} = 3.67$		$\frac{2.25}{0.69} = 3.26$	$K_s = 0.69$
	FL 1	$\frac{4.41}{1.2} = 3.68$		$\frac{3.67}{1.2} = 3.06$		$\frac{3.26}{1.2} = 2.72$	
Masonry requirements	FL 1	20-5.0-M3		20-3.5-M2		20-3.5-M2	

*Loads, stresses and masonry requirements for 1½ brick, 30 cm thick wall.

Case 9 Loads and Stresses

Particulars (1)	Wall A		Wall B		Wall C		Remarks (8)
	Individual Load	Progressive Load	Individual Load	Progressive Load	Individual Load	Progressive Load	
	kg/m (2)	kg/m (3)	kg/m (4)	kg/m (5)	kg/m (6)	kg/m (7)	
Parapet wall	440	440	—	—	—	—	
Roof	1 220	1 660	3 150	3 150	2 230	2 230	
Third storey wall	1 450	3 110	1 450	4 600	1 450	3 680	
Floor 3	1 330	4 440	3 430	8 030	2 710	6 390	
Second storey wall	1 450	5 890	1 450	9 480	1 450	7 840	
Floor 2	1 330	7 220	3 430	12 910	2 710	10 550	
First storey wall	1 450	8 670	1 450	14 360	1 450	12 000	
First storey wall*	1 980	9 200	1 980	14 980	1 980	12 530	
		kg/cm ²		kg/cm ²		kg/cm ²	
Compressive stress in masonry wall without openings	FL 3	$\frac{3\ 110}{19 \times 100} = 1.64$		$\frac{4\ 600}{19 \times 100} = 2.42$		$\frac{3\ 680}{19 \times 100} = 1.94$	
	FL 2	$\frac{5\ 890}{19 \times 100} = 3.10$		$\frac{9\ 480}{19 \times 100} = 4.99$		$\frac{7\ 840}{19 \times 100} = 4.13$	
	FL 1	$\frac{8\ 670}{19 \times 100} = 4.56$		$\frac{14\ 360}{19 \times 100} = 7.56$		$\frac{12\ 000}{19 \times 100} = 6.32$	
	FL 1*	$\frac{9\ 200}{29 \times 100} = 3.17$		$\frac{14\ 890}{29 \times 100} = 5.13$		$\frac{12\ 530}{29 \times 100} = 4.32$	
Compressive stress in masonry wall with openings	FL 3	$\frac{1.64}{0.50} = 3.28$		$\frac{2.42}{0.85} = 2.85$		$\frac{1.94}{0.80} = 2.43$	
	FL 2	$\frac{3.10}{0.50} = 6.20$		$\frac{4.99}{0.85} = 5.87$		$\frac{4.13}{0.80} = 5.16$	
	FL 1	$\frac{4.56}{0.50} = 9.12$		$\frac{7.56}{0.85} = 8.89$		$\frac{6.32}{0.80} = 7.90$	
	FL 1*	$\frac{3.17}{0.50} = 6.34$		$\frac{5.13}{0.85} = 6.04$		$\frac{4.32}{0.80} = 5.40$	
<i>For Three-Storeyed Building</i>							
Basic stress of requisite masonry without application of shape modification factor	FL 3	$\frac{3.28}{0.81} = 4.05$		$\frac{2.85}{0.81} = 3.52$		$\frac{2.43}{0.81} = 3.0$	$K_s = 0.81$
	FL 2	$\frac{6.20}{0.81} = 7.65$		$\frac{5.87}{0.81} = 7.25$		$\frac{5.16}{0.81} = 6.37$	$K_s = 0.81$
	FL 1	$\frac{9.12}{0.72} = 12.67$		$\frac{8.89}{0.72} = 12.35$		$\frac{7.90}{0.72} = 10.97$	$K_s = 0.72$
	FL 1*	$\frac{6.34}{0.88} = 7.20$		$\frac{6.04}{0.88} = 6.86$		$\frac{5.40}{0.88} = 6.14$	$K_s = 0.88$
Basic stress of requisite masonry after application of shape modification factor	FL 3	$\frac{4.05}{1.2} = 3.4$		$\frac{3.52}{1.2} = 2.9$		$\frac{3.0}{1.2} = 2.5$	
	FL 2	$\frac{7.65}{1.1} = 7.0$		$\frac{7.25}{1.1} = 6.6$		$\frac{6.37}{1.1} = 5.8$	
	FL 1	$\frac{12.67}{1.0} = 12.7$		$\frac{12.35}{1.0} = 12.4$		$\frac{10.97}{1.0} = 11.0$	
	FL 1*	$\frac{7.20}{1.1} = 6.5$		$\frac{6.86}{1.1} = 6.2$		$\frac{6.14}{1.1} = 5.6$	

(Continued)

Case 9—Concluded

Particulars		Wall A	Wall B	Wall C	Remarks
		kg/cm ²	kg/cm ²	kg/cm ²	
Masonry requirements	FL 3	20-3.5-M2	20-3.5-M2	20-3.5-L2	
	FL 2	20-7.5-M1	20-7.5-M1	20-7.5-M2	
	FL 1	20-15.0-H1	20-15.0-H1	20-12.5-H2	
	FL 1*	30-7.5-M1	30-7.5-M2	30-7.5-M3	
<i>For Two-Storeyed Building</i>					
Basic stress of requisite masonry without application of shape modification factor	FL 2	$\frac{3.28}{0.81} = 4.05$	$\frac{2.85}{0.81} = 3.52$	$\frac{2.43}{0.81} = 3.0$	$K_s = 0.81$
	FL 1	$\frac{6.20}{0.72} = 8.61$	$\frac{5.87}{0.72} = 8.16$	$\frac{5.16}{0.72} = 7.17$	$K_s = 0.72$
Basic stress of requisite masonry after application of shape modification factor	FL 2	$\frac{4.05}{1.2} = 3.33$	$\frac{3.52}{1.2} = 2.9$	$\frac{3.0}{1.2} = 2.6$	
	FL 1	$\frac{8.61}{1.1} = 7.8$	$\frac{8.16}{1.1} = 7.4$	$\frac{7.17}{1.1} = 6.5$	
Masonry requirements	FL 2	20-3.5-M2	20-3.5-M2	20-3.5-L2	
	FL 1	20-10-M2	20-7.5-M1	20-7.5-M1	
<i>For One-Storeyed Building</i>					
Basic stress of requisite masonry without application of shape modification factor	FL 1	$\frac{3.28}{0.72} = 4.56$	$\frac{2.85}{0.72} = 3.96$	$\frac{2.43}{0.72} = 3.37$	$K_s = 0.72$
Basic stress of requisite masonry after application of shape modification factor	FL 1	$\frac{4.36}{1.2} = 3.8$	$\frac{3.96}{1.2} = 3.3$	$\frac{2.37}{1.2} = 2.8$	
Masonry requirements	FL 1	20-5.0-M3	20-3.5-M2	20-3.5-M2	

*Loads, stresses and masonry requirements for 1½ brick, 30 cm thick wall.

Case 10 Loads and Stresses

Particulars (1)	Wall A		Wall B		Wall C		Remarks (8)
	Individual Load	Progressive Load	Individual Load	Progressive Load	Individual Load	Progressive Load	
	kg/m	kg/m	kg/m	kg/m	kg/m	kg/m	
Parapet wall	440	440	—	—	—	—	
Roof	1 220	1 660	3 150	3 150	2 230	2 230	
Third storey wall	1 450	3 110	1 450	4 600	1 450	3 680	
Floor 3	1 540	4 650	3 970	8 570	2 920	6 600	
Second storey wall	1 450	6 100	1 450	10 020	1 450	8 050	
Floor 2	1 540	7 640	3 970	13 990	2 920	10 970	
First storey wall	1 450	9 090	1 450	15 440	1 450	12 420	
First storey wall*	1 980	9 620	1 980	15 970	1 980	12 950	
		kg/cm ²		kg/cm ²		kg/cm ²	
Compressive stress in masonry wall without openings	FL 3	$\frac{3\ 110}{19 \times 100} = 1.64$		$\frac{4\ 600}{19 \times 100} = 2.42$		$\frac{3\ 680}{19 \times 100} = 1.94$	
	FL 2	$\frac{6\ 100}{19 \times 100} = 3.21$		$\frac{10\ 020}{19 \times 100} = 5.27$		$\frac{8\ 050}{19 \times 100} = 4.24$	
	FL 1	$\frac{9\ 090}{19 \times 100} = 4.78$		$\frac{15\ 440}{19 \times 100} = 8.13$		$\frac{12\ 420}{19 \times 100} = 6.54$	
	FL 1*	$\frac{9\ 620}{29 \times 100} = 3.32$		$\frac{15\ 970}{29 \times 100} = 5.51$		$\frac{12\ 950}{29 \times 100} = 4.47$	
Compressive stress in masonry wall with openings	FL 3	$\frac{1.64}{0.50} = 3.28$		$\frac{2.42}{0.85} = 2.85$		$\frac{1.94}{0.80} = 2.43$	
	FL 2	$\frac{3.21}{0.50} = 6.42$		$\frac{5.27}{0.85} = 6.20$		$\frac{4.24}{0.80} = 5.30$	
	FL 1	$\frac{4.78}{0.50} = 9.56$		$\frac{8.13}{0.85} = 9.56$		$\frac{6.54}{0.80} = 8.18$	
	FL 1*	$\frac{3.32}{0.50} = 6.64$		$\frac{5.51}{0.85} = 6.48$		$\frac{4.47}{0.80} = 5.59$	
<i>For Three-Storeyed Building</i>							
Basic stress of requisite masonry without application of shape modification factor	FL 3	$\frac{3.28}{0.81} = 4.05$		$\frac{2.85}{0.81} = 3.52$		$\frac{2.43}{0.81} = 3.0$	$K_s = 0.81$
	FL 2	$\frac{6.42}{0.81} = 7.93$		$\frac{6.20}{0.81} = 7.65$		$\frac{5.30}{0.81} = 6.54$	$K_s = 0.81$
	FL 1	$\frac{9.56}{0.72} = 13.28$		$\frac{9.56}{0.72} = 13.19$		$\frac{8.18}{0.72} = 11.36$	$K_s = 0.72$
	FL 1*	$\frac{6.64}{0.88} = 7.55$		$\frac{6.48}{0.88} = 7.36$		$\frac{5.59}{0.88} = 6.35$	$K_s = 0.88$
Basic stress of requisite masonry after application of shape modification factor	FL 3	$\frac{4.05}{1.2} = 3.175$		$\frac{3.52}{1.2} = 2.9$		$\frac{3.0}{1.2} = 2.5$	
	FL 2	$\frac{7.93}{1.1} = 7.2$		$\frac{7.65}{1.1} = 7.0$		$\frac{6.54}{1.1} = 5.9$	
	FL 1	$\frac{13.28}{1.0} = 13.3$		$\frac{13.19}{1.0} = 13.2$		$\frac{11.36}{1.0} = 11.4$	
	FL 1*	$\frac{7.55}{1.1} = 6.9$		$\frac{7.36}{1.1} = 6.7$		$\frac{6.35}{1.1} = 5.8$	

(Continued)

Case 10—Concluded

Particulars		Wall A		Wall B		Wall C	Remarks
		kg/cm ²		kg/cm ²		kg/cm ²	
Masonry requirements	FL 1	20-3.5-M2		20-3.5-M2		20-3.5-L2	
	FL 2	20-7.5-M1		20-7.5-M1		20-7.5-M2	
	FL 3*	30-7.5-M1		30-7.5-M1		30-7.5-M2	
<i>For Two-Storeyed Building</i>							
Basic stress of requisite masonry without application of shape modification factor	FL 2	$\frac{3.28}{0.81}$	= 4.05	$\frac{2.85}{0.81}$	= 3.52	$\frac{2.43}{0.81}$	= 3.0 $K_s = 0.81$
	FL 1	$\frac{6.42}{0.72}$	= 8.92	$\frac{6.20}{0.72}$	= 8.61	$\frac{5.30}{0.72}$	= 7.36 $K_s = 0.72$
Basic stress of requisite masonry after application of shape modification factor	FL 2	$\frac{4.05}{1.2}$	= 3.38	$\frac{3.52}{1.2}$	= 2.9	$\frac{3.0}{1.2}$	= 2.5
	FL 1	$\frac{8.92}{1.1}$	= 8.1	$\frac{8.61}{1.1}$	= 7.8	$\frac{7.30}{1.1}$	= 6.7
Masonry requirements	FL 2	20-5.0-M3		20-3.5-M2		20-3.5-L2	
	FL 1	20-10-M2		20-10-M2		20-7.5-M1	
<i>For One-Storeyed Building</i>							
Basic stress of requisite masonry without application of shape modification factor	FL 1	$\frac{3.28}{0.72}$	= 4.56	$\frac{2.85}{0.72}$	= 3.96	$\frac{2.43}{0.72}$	= 3.37 $K_s = 0.72$
Basic stress of requisite masonry after application of shape modification factor	FL 1	$\frac{4.56}{1.2}$	= 3.8	$\frac{3.96}{1.2}$	= 3.3	$\frac{3.37}{1.2}$	= 2.80
Masonry requirements	FL 1	20-5.0-M3		20-3.5-M2		20-3.5-M2	

*Loads, stresses and masonry requirements for 1½ brick, 30 cm thick wall.

Case 11 Loads and Stresses

Particulars	Wall A		Wall B		Wall C		Remarks
	Individual Load	Progressive Load	Individual Load	Progressive Load	Individual Load	Progressive Load	
	kg/m	kg/m	kg/m	kg/m	kg/m	kg/m	
(1)	(2)	(3)	(4)	(5)	(6)	(7)	(8)
Parapet wall	440	440	—	—	—	—	
Roof	1 220	1 660	3 150	3 150	2 230	2 230	
Third storey wall	1 580	3 240	1 580	4 730	1 580	3 810	
Floor 3	1 330	4 570	3 430	8 160	2 710	6 520	
Second storey wall	1 580	6 150	1 580	9 740	1 580	8 100	
Floor 2	1 330	7 480	3 430	13 170	2 710	10 810	
First storey wall	1 580	9 060	1 580	14 750	1 580	12 390	
First storey wall*	2 170	9 650	2 170	15 340	2 170	12 980	
		kg/cm ²		kg/cm ²		kg/cm ²	
Compressive stress in masonry wall without openings	FL 3	$\frac{3\ 240}{19 \times 100} = 1.71$	FL 3	$\frac{4\ 730}{19 \times 100} = 2.49$	FL 3	$\frac{3\ 810}{19 \times 100} = 2.01$	
	FL 2	$\frac{6\ 150}{19 \times 100} = 3.24$	FL 2	$\frac{9\ 740}{19 \times 100} = 5.13$	FL 2	$\frac{8\ 100}{19 \times 100} = 4.26$	
	FL 1	$\frac{9\ 060}{19 \times 100} = 4.77$	FL 1	$\frac{14\ 750}{19 \times 100} = 7.76$	FL 1	$\frac{12\ 390}{19 \times 100} = 6.52$	
	FL 1*	$\frac{9\ 650}{29 \times 100} = 3.33$	FL 1*	$\frac{15\ 340}{29 \times 100} = 5.29$	FL 1*	$\frac{12\ 980}{19 \times 100} = 4.48$	
Compressive stress in masonry wall with openings	FL 3	$\frac{1.71}{0.50} = 3.42$	FL 3	$\frac{2.49}{0.85} = 2.93$	FL 3	$\frac{2.01}{0.80} = 2.51$	
	FL 2	$\frac{3.24}{0.50} = 6.48$	FL 2	$\frac{5.13}{0.85} = 6.04$	FL 2	$\frac{4.26}{0.80} = 5.33$	
	FL 1	$\frac{4.77}{0.50} = 9.54$	FL 1	$\frac{7.76}{0.85} = 9.13$	FL 1	$\frac{6.52}{0.80} = 8.15$	
	FL 1*	$\frac{3.33}{0.50} = 6.66$	FL 1*	$\frac{5.29}{0.85} = 6.22$	FL 1*	$\frac{4.48}{0.80} = 5.60$	
<i>For Three-Storeyed Building</i>							
Basic stress of requisite masonry without application of shape modification factor	FL 3	$\frac{3.42}{0.78} = 4.38$	FL 3	$\frac{2.93}{0.78} = 3.76$	FL 3	$\frac{2.51}{0.78} = 3.22$	$K_s = 0.78$
	FL 2	$\frac{6.48}{0.78} = 8.31$	FL 2	$\frac{6.04}{0.78} = 7.74$	FL 2	$\frac{5.33}{0.78} = 6.83$	$K_s = 0.78$
	FL 1	$\frac{9.54}{0.69} = 13.82$	FL 1	$\frac{9.13}{0.69} = 13.23$	FL 1	$\frac{8.15}{0.69} = 11.81$	$K_s = 0.69$
	FL 1*	$\frac{6.66}{0.86} = 7.74$	FL 1*	$\frac{6.22}{0.86} = 7.23$	FL 1*	$\frac{5.60}{0.86} = 6.51$	$K_s = 0.86$
Basic stress of requisite masonry after application of shape modification factor	FL 3	$\frac{4.38}{1.2} = 3.65$	FL 3	$\frac{3.76}{1.2} = 3.13$	FL 3	$\frac{3.22}{1.2} = 2.7$	
	FL 2	$\frac{8.31}{1.1} = 7.6$	FL 2	$\frac{7.74}{1.1} = 7.0$	FL 2	$\frac{6.83}{1.1} = 6.2$	
	FL 1	$\frac{13.82}{1.0} = 13.8$	FL 1	$\frac{13.23}{1.0} = 13.2$	FL 1	$\frac{11.81}{1.0} = 11.8$	
	FL 1*	$\frac{7.74}{1.1} = 7.0$	FL 1*	$\frac{7.23}{1.1} = 6.6$	FL 1*	$\frac{6.51}{1.1} = 5.9$	

(Continued)

Case 11—Concluded

Particulars		Wall A		Wall B		Wall C	Remarks
		kg/cm ²		kg/cm ²		kg/cm ²	
Masonry requirements	FL 3	20-5.0-M3		20-3.5-M2		20-3.5-M2	
	FL 2	20-10-M3		20-7.5-M1		20-7.5-M1	
	FL 1*	30-7.5-M1		30-7.5-M1		30-7.5-M2	

For Two-Storeyed Building

Basic stress of requisite masonry without application of shape modification factor	FL 2	$\frac{3.42}{0.78} = 4.38$		$\frac{2.93}{0.78} = 3.76$		$\frac{2.51}{0.78} = 3.22$	$K_s = 0.78$
	FL 1	$\frac{6.48}{0.69} = 9.39$		$\frac{6.04}{0.69} = 8.75$		$\frac{5.33}{0.69} = 7.72$	$K_s = 0.69$
Basic stress of requisite masonry after application of shape modification factor	FL 2	$\frac{4.38}{1.2} = 3.65$		$\frac{3.76}{1.2} = 3.13$		$\frac{3.22}{1.2} = 2.7$	
	FL 1	$\frac{9.39}{1.1} = 8.5$		$\frac{8.75}{1.1} = 8.0$		$\frac{7.72}{1.1} = 7.0$	
Masonry requirements	FL 2	20-5.0-M3		20-3.5-M2		20-3.5-M2	
	FL 1	20-10-M1		20-10-M2		20-7.5-M1	

For One-Storeyed Building

Basic stress of requisite masonry without application of shape modification factor	FL 1	$\frac{3.42}{0.69} = 4.96$		$\frac{2.93}{0.69} = 4.25$		$\frac{2.51}{0.69} = 3.63$	$K_s = 0.69$
	FL 1	$\frac{4.98}{1.2} = 4.15$		$\frac{4.25}{1.2} = 3.54$		$\frac{3.63}{1.2} = 3.03$	
Masonry requirements	FL 1	20-5.0-M2		20-3.5-M2		20-3.5-M2	

*Loads, stresses and masonry requirements for 1½ brick, 30 cm thick wall.

Case 12 Loads and Stresses

Particulars (1)	Wall A		Wall B		Wall C		Remarks (8)
	Individual Load	Progressive Load	Individual Load	Progressive Load	Individual Load	Progressive Load	
	kg/m (2)	kg/m (3)	kg/m (4)	kg/m (5)	kg/m (6)	kg/m (7)	
Parapet wall	440	440	—	—	—	—	
Roof	1 220	1 660	3 150	3 150	2 230	2 230	
Third storey wall	1 580	3 240	1 580	4 730	1 580	3 810	
Floor 3	1 540	4 780	3 970	8 700	2 920	6 730	
Second storey wall	1 580	6 360	1 580	10 280	1 580	8 310	
Floor 2	1 540	7 900	3 970	14 250	2 920	11 230	
First storey wall	1 580	9 480	1 580	15 830	1 580	12 810	
First storey wall*	2 170	10 070	2 170	16 420	2 170	13 400	

		kg/cm ²		kg/cm ²		kg/cm ²
Compressive stress in masonry wall without openings	FL 3	$\frac{3\ 240}{19 \times 100} = 1.71$		$\frac{4\ 730}{19 \times 100} = 2.49$		$\frac{3\ 810}{19 \times 100} = 2.01$
	FL 2	$\frac{6\ 360}{19 \times 100} = 3.35$		$\frac{10\ 280}{19 \times 100} = 5.41$		$\frac{8\ 310}{19 \times 100} = 4.37$
	FL 1	$\frac{9\ 480}{19 \times 100} = 4.99$		$\frac{15\ 830}{19 \times 100} = 8.33$		$\frac{12\ 810}{19 \times 100} = 6.74$
	FL 1*	$\frac{10\ 070}{29 \times 100} = 3.47$		$\frac{16\ 420}{29 \times 100} = 5.66$		$\frac{13\ 400}{29 \times 100} = 4.62$
Compressive stress in masonry wall with openings	FL 3	$\frac{1.71}{0.50} = 3.42$		$\frac{2.49}{0.85} = 2.93$		$\frac{2.01}{0.80} = 2.51$
	FL 2	$\frac{3.35}{0.50} = 6.70$		$\frac{5.41}{0.85} = 6.36$		$\frac{4.37}{0.80} = 5.46$
	FL 1	$\frac{4.99}{0.50} = 9.98$		$\frac{8.33}{0.85} = 9.80$		$\frac{6.74}{0.80} = 8.43$
	FL 1*	$\frac{3.47}{0.50} = 6.94$		$\frac{5.66}{0.85} = 6.66$		$\frac{4.62}{0.80} = 5.78$

For Three-Storeyed Building

Basic stress of requisite masonry without application of shape modification factor	FL 3	$\frac{3.42}{0.78} = 4.38$		$\frac{2.93}{0.78} = 3.76$		$\frac{2.51}{0.78} = 3.22$	$K_s = 0.78$
	FL 2	$\frac{6.70}{0.78} = 8.59$		$\frac{6.36}{0.78} = 8.15$		$\frac{5.46}{0.78} = 7.0$	$K_s = 0.78$
	FL 1	$\frac{9.98}{0.69} = 14.46$		$\frac{9.80}{0.69} = 14.20$		$\frac{8.43}{0.69} = 12.22$	$K_s = 0.69$
	FL 1*	$\frac{6.94}{0.86} = 8.07$		$\frac{6.66}{0.86} = 7.74$		$\frac{5.78}{0.86} = 6.72$	$K_s = 0.86$
Basic stress of requisite masonry after application of shape modification factor	FL 3	$\frac{4.38}{1.2} = 3.65$		$\frac{3.76}{1.2} = 3.13$		$\frac{3.22}{1.2} = 2.7$	
	FL 2	$\frac{8.59}{1.1} = 7.8$		$\frac{8.15}{1.1} = 7.4$		$\frac{7.0}{1.1} = 6.4$	
	FL 1	$\frac{14.46}{1.0} = 14.5$		$\frac{14.20}{1.0} = 14.2$		$\frac{12.22}{1.0} = 12.2$	
	FL 1*	$\frac{8.1}{1.1} = 7.3$		$\frac{7.74}{1.1} = 7.0$		$\frac{6.72}{1.1} = 6.1$	

(Continued)

Case 12 — Concluded

Particulars		Wall A	Wall B	Wall C	Remarks
		kg/cm ²	kg/cm ²	kg/cm ²	
Masonry requirements	FL 3	20-5.0-M3	20-3.5-M2	20-3.5-M2	
	FL 2	20-10-M3	20-7.5-M1	20-7.5-M1	
	FL 1*	30-7.5-M1	30-7.5-M1	30-7.5-M2	
<i>For Two-Storeyed Building</i>					
Basic stress of requisite masonry without application of shape modification factor	FL 2	$\frac{3.42}{0.78} = 4.38$	$\frac{2.93}{0.78} = 3.76$	$\frac{2.51}{0.78} = 3.22$	$K_s = 0.78$
	FL 1	$\frac{6.70}{0.69} = 9.71$	$\frac{6.36}{0.69} = 9.22$	$\frac{5.46}{0.69} = 7.91$	$K_s = 0.69$
Basic stress of requisite masonry after application of shape modification factor	FL 2	$\frac{4.38}{1.2} = 3.65$	$\frac{3.76}{1.2} = 3.13$	$\frac{3.22}{1.2} = 2.7$	
	FL 1	$\frac{9.71}{1.0} = 9.7$	$\frac{9.22}{1.1} = 8.44$	$\frac{7.91}{1.1} = 7.2$	
Masonry requirements	FL 2	20-5.0-M3	20-3.5-M2	20-3.5-M2	
	FL 1	20-10-M1	20-10-M1	20-7.5-M1	
<i>For One-Storeyed Building</i>					
Basic stress of requisite masonry without application of shape modification factor	FL 1	$\frac{3.42}{0.69} = 4.96$	$\frac{2.93}{0.69} = 4.25$	$\frac{2.51}{0.69} = 3.64$	$K_s = 0.69$
Basic stress of requisite masonry after application of shape modification factor	FL 1	$\frac{4.96}{1.2} = 4.13$	$\frac{4.25}{1.2} = 3.54$	$\frac{3.64}{1.2} = 3.03$	
Masonry requirements	FL 1	20-5.0-M2	20-3.5-M2	20-3.5-M2	

*Loads, stresses and masonry requirements for 1½ brick, 30 cm thick wall.

Table E-18 Design Results of Brick Masonry Walls for Office Buildings Up to 3 Storeys

Sl No.	Span (m)	Storey Height (m)	Live Load (kg/m)	Storey Level	Three Storeyed Building		Double Storeyed Building		Single Storey Building	
					Internal Wall (6)	External Wall (7)	Internal Wall (8)	External Wall (9)	Internal Wall (10)	External Wall (11)
1.	3.6	3.0	250	FL 3 FL 2 FL 1	20-3.5-L2 20-5.0-M2 20-10-M1	20-3.5-L2 20-7.5-M3 20-10-H1 or 30-7.5-L1	20-3.5-L2 20-7.5-L1	20-3.5-M2 20-7.5-M1	20-3.5-L2	20-3.5-M2
2.	3.6	3.0	400	FL 3 FL 2 FL 1	20-3.5-L2 20-5.0-M1 20-10-M1	20-3.5-M2 20-7.5-M3 20-12.5-H1 or 30-7.5-M3	20-3.5-L2 20-7.5-M3	20-3.5-M2 20-7.5-M1	20-3.5-L2	20-3.5-M2
3.	3.6	3.30	250	FL 3 FL 2 FL 1	20-3.5-L2 20-7.5-L1 20-10-H1 or 30-7.5-L1	20-3.5-M2 20-7.5-M1 20-12.5-H1 or 30-7.5-M2	20-3.5-L2 20-7.5-M2	20-3.5-M2 20-7.5-M1	20-3.5-M2	20-5.0-L1
4.	3.6	3.30	400	FL 3 FL 2 FL 1	20-3.5-L2 20-7.5-M3 20-10-M1 or 30-7.5-M1	20-3.5-M2 20-7.5-M1 20-12.5-M1 or 30-7.5-M2	20-3.5-L1 20-7.5-M1	20-3.5-M2 20-7.5-M1	20-3.5-M2	20-5.0-L1
5.	4.5	3.0	250	FL 3 FL 2 FL 1	20-3.5-L2 20-7.5-M3 20-12.5-M1 or 30-7.5-M3	20-3.5-M2 20-7.5-M1 20-12.5-M1 or 30-7.5-M2	20-3.5-L2 20-7.5-M1	20-3.5-M2 20-7.5-M1	20-3.5-M2	20-5.0-L1
6.	4.5	3.0	400	FL 3 FL 2 FL 1	20-3.5-L2 20-7.5-M1 20-12.5-H1 or 30-7.5-M2	20-3.5-M2 20-7.5-M1 20-12.5-H1 or 30-7.5-M1	20-3.5-L2 20-7.5-M1	20-3.5-M2 20-7.5-M1	20-3.5-M2	20-5.0-L1
7.	4.5	3.30	250	FL 3 FL 2 FL 1 FL 1*	20-3.5-M2 20-7.5-M1 20-12.5-H1 or 30-7.5-M2	20-3.5-M2 20-7.5-M1 20-15-H1 or 30-7.5-M1	20-3.5-M2 20-7.5-M1	20-3.5-M2 20-7.5-H1	20-3.5-M2	20-5.0-M3
8.	4.5	3.30	400	FL 3 FL 2 FL 1 FL 1*	20-3.5-M2 20-7.5-M1 20-15.0-H1 or 30-7.5-M1	20-3.5-M2 20-7.5-M1 20-15.0-H1 or 30-7.5-M1	20-3.5-M2 20-7.5-M1	20-3.5-M2 20-10-M2	20-3.5-M2	20-5.0-M3

(Continued)

Table E-18 — Concluded

(1)	(2)	(3)	(4)	(5)	(6)	(7)	(8)	(9)	(10)	(11)
9.	5.40	3.00	250	FL 3	20-3.5-M2	20-3.5-M2				
				FL 2	20-7.5-M1	20-7.5-M1	20-3.5-M2	20-3.5-M2		
				FL 1	20-15.0-H1 or	20-15.0-H1 or	20-7.5-M1	20-10-M2	20-3.5-M2	20-5.0-M3
				FL 1*	30-7.5-M1	30-7.5-M1				
10.	5.40	3.00	400	FL 3	20-3.5-M2	20-3.5-M2				
				FL 2	20-7.5-M1	20-7.5-M1	20-3.5-M2	20-3.5-M3		
				FL 1	—	—	20-10-M2	20-10.0-M2	20-3.5-M2	20-5.0-M3
				FL 1*	30-7.5-M1	30-7.5-M1				
11.	5.40	3.30	250	FL 3	20-3.5-M2	20-5.0-M3				
				FL 2	20-7.5-M1	20-10-M2	20-3.5-M2	20-5.0-M3		
				FL 1	—	—	20-10-M2	20-10-M1	20-3.5-M2	20-3.5-M2
				FL 1*	30-7.5-M1	30-7.5-M1				
12.	5.40	3.30	400	FL 3	20-5.5-M2	20-5.0-M3				
				FL 2	20-7.5-M1	20-10-M2	20-5.0-M3	20-3.5-M2		
				FL 1	—	—	20-10.0-M1	20-10-M1	20-3.5-M2	20-5.0-M2
				FL 1*	30-7.5-M1	30-7.5-M1				

**Table E-19 Design Results of Brick Masonry Walls for Office Building Up to 3 Storeys
(Using Conventional* Bricks)**

Sl No.	Span (m)	Storey Height (m)	Live Load (kg/m ²)	Storey Level	Three Storeyed Building		Double Storeyed Building		Single Storey Building	
					Internal Wall	External Wall	Internal Wall	External Wall	Internal Wall	External Wall
1.	3.6	3.00	250	FL 3	23-3.5-M2	23-3.5-L2				
				FL 2	23-7.5-L1	23-5.0-M2	23-3.5-M2	23-3.5-L2		
				FL 1	23-10-M1	23-7.5-H1	23-7.5-M2	23-5-M1	23-3.5-M2	23-3.5-L2
2.	3.6	3.00	400	FL 3	23-3.5-M2	23-3.5-L2				
				FL 2	23-7.5-M3	23-5-M1	23-3.5-M2	23-3.5-L2		
				FL 1	23-10-M1	23-10-M2	23-7.5-M2	23-7.5-L1	23-3.5-M2	23-3.5-L2
3.	3.6	3.30	250	FL 3	23-3.5-M2	23-3.5-L2				
				FL 2	23-7.5-M2	23-5.0-M1	23-3.5-M2	23-3.5-L2		
				FL 1	23-10-M1	23-10-M2	23-7.5-M1	23-7.5-L1	23-3.5-M2	23-3.5-L2
4.	3.6	3.3	400	FL 3	23-3.5-M2	23-3.5-L2				
				FL 2	23-7.5-M2	23-7.5-L1	23-3.5-M2	23-3.5-L2		
				FL 1	23-10-H2	23-10-M1	23-7.5-M1	23-7.5-M3	23-3.5-M2	23-3.5-L2
5.	4.5	3.0	250	FL 3	23-3.5-M2	23-3.5-M2				
				FL 2	23-7.5-M1	23-7.5-M2	23-3.5-M2	23-3.5-M2		
				FL 1	23-10-M1	23-10-M1	23-7.5-M1	23-7.5-M1	23-3.5-M2	23-3.5-M2
6.	4.5	3.0	400	FL 3	23-3.5-M2	23-3.5-M2				
				FL 2	23-7.5-M1	23-7.5-M1	23-3.5-M2	23-3.5-M2		
				FL 1	23-10-H1 or 34.5-7.5-M1	34.5-7.5-M1	23-7.5-M1	23-3.5-M1	23-3.5-M2	23-3.5-M2
7.	4.5	3.3	250	FL 3	23-3.5-M2	23-3.5-M2				
				FL 2	23-7.5-M1	23-7.5-M1	23-3.5-M2	23-3.5-M2		
				FL 1	34.5-7.5-M1	23-10.0-M1	23-7.5-M1	23-7.5-M1	23-5.0-M3	23-3.5-M2
8.	4.5	3.3	400	FL 3	23-3.5-M2	23-3.5-M2				
				FL 2	23-7.5-M1	23-7.5-M1	23-3.5-M2	23-3.5-M2		
				FL 1	34.5-7.5-M1	34.5-7.5-M1	23-7.5-M1	23-7.5-M1	23-3.5-M2	23-3.5-M2
9.	5.1	3.0	250	FL 3	23-5.0-L1	23-3.5-M2				
				FL 2	23-7.5-M1	23-7.5-M1	23-7.5-L2	23-3.5-M2		
				FL 1	34.5-7.5-M1	34.5-7.5-M1	23-3.5-M1	23-7.5-M1	23-3.5-L2	23-3.5-M2
10.	5.4	3.0	400	FL 3	23-5.0-L1	23-3.5-M2				
				FL 2	23-7.5-M1	23-7.5-M1	23-5.0-L1	23-3.5-M2		
				FL 1	34.5-7.5-M1	34.5-7.5-M1	23-10-M2	23-7.5-M1	23-5.0-M3	23-3.5-M2
11.	5.4	3.3	250	FL 3	23-5.0-M3	23-3.5-M2				
				FL 2	23-7.5-M1	23-7.5-M1	23-5.0-M3	23-3.5-M2		
				FL 1	34.5-7.5-M1	34.5-7.5-M1	23-10-M2	23-10-M2	23-5.0-M2	23-5.0-M3
12.	5.4	3.3	400	FL 3	23-5.0-M3	23-3.5-M2				
				FL 2	23-10-M2	23-7.5-M1	23-5.0-M3	23-3.5-M2		
				FL 1	34.5-10-M2	23-7.5-M1	23-10-M1	23-10-M2	23-5.0-M2	23-5.0-M3

*Bricks of nominal size 23 cm × 11.5 cm × 7.7 cm.

ANNEX H-4

NOTATIONS, SYMBOLS AND ABBREVIATIONS

H-4.1 Notations, Symbols and Abbreviations from the Code are reproduced below along with additions used in the handbook for ready reference.

NOTE—When any Notation has more than one meaning its intended meaning will be with reference to the context.

A	= Hydraulic lime
A	= Area of a Section
b	= Width of a rectangular Section or Width of bearing of a vertical load
B	= Semi-hydraulic lime
BM	= Bending moment
C	= Fat lime
d	= Depth of a rectangular Section
DL	= Dead load
DPC	= Damp proof course
e	= Eccentricity as distance from centroid
\bar{e}	= Resultant eccentricity as distance from centroid
f	= Stress (either compressive or tensile)
f_b	= Basic compressive stress
f_c	= Compressive stress/Permissible compressive stress
f_d	= Compressive stress due to dead loads
f_m	= Compressive strength of a masonry as per prism test
f_s	= Shear permissible stress
f_t	= Tensile stress
GL	= Ground level
H	= Actual height between lateral Supports or Total wall height above the level being analysed
H'	= Height of an opening
H1, H2	= High strength mortars
h	= Effective height of a masonry element between lateral supports
I	= Moment of inertia
k_a	= Area reduction factor
k_p	= Shape modification factor
k_s	= Stress reduction factor
k_n	= Stiffening co-efficient of a wall
L	= Actual length of a masonry wall
l	= Effective length of a masonry wall
LL	= Live load
L1 L2 L3	= Low strength mortars
M	= Moment
M1 M2 M3	= Medium strength mortars
NA	= Neutral axis
p	= Unit wind pressure/Lateral load
P	= Total wind force/Horizontal load
PL	= Plinth level
RS	= Rolled steel
RCC	= Reinforced cement concrete
SR	= Slenderness ratio
S_p	= Spacing of piers/Buttresses/Cross walls
t	= Actual thickness
t_e	= Effective thickness
t_p	= Thickness of pier
t_w	= Thickness of wall

W	= Vertical load/Weight or Resultant load
W_1	= Axial load
W_2	= Eccentric load
W_p	= Width of piers/Buttresses/Cross walls
Y	= Distance of extreme fibre of a section from neutral axis
Z	= Modulus of a section
μ	= Ratio of flexural strength of wall in the vertical direction to that in the horizontal direction

REFERENCES

1. Proceedings of the International Conference on Planning and Design of Tall Buildings, Lehigh University, 1973. Volume III Structural Design of Tall Concrete and Masonry Buildings. American Society of Civil Engineers, New York.
2. CP 111 : Part 2 : 1970 Structural Recommendation for Load Bearing Walls. Metric Units. British Standards Institution.
3. Masonry Designs for Building - National Standard of Canada CAN3-S304-M84.
4. Recommended Practice for Engineered Brick Masonry, 1969. Brick Institute of America, Virginia.
5. IS 2250 : 1981 Code of Practice for Preparation and Use of Mortars.
6. Building Research Station Digest 61 (Second Series). Strength of Brickwork, Blockwork and Concrete Walls.
7. Proceedings of the Second International Brick Masonry Conference held in Stoke-on-Trent, England 1970.
8. AS 1640 : 1974 SAA Brickwork Code (Metric Units). Standards Association of Australia.
9. BS 5628 : Part 1 : 1978 Code of Practice for Structural Use of Masonry: Part 2 Unreinforced Masonry. British Standards Institution.
10. Monk, C. B. Jr., Old and New Research on Clay Masonry Bearing Wall. First National Brick and Tile Bearing Walls Conference (May 1965), Pittsburg.
11. ISO—Third Working Draft Part I—1987 Code of Practice for Structural use of Unreinforced Masonry International Organisation for Standardization.
12. CP 121 : Part 1 : 1973 Code of Practice for Walling: Part 1 Brick and Block Masonry. British Standards Institution.
13. Brick Diaphragm Walls in Tall Single Storey Buildings by W. G. Curtin and G. Shaw.
14. IS 1641 to IS : 1648 Code of Practice for Fire Safety of Buildings.
15. IS 3792-1978 Guide for Heat Insulation of Non-Industrial Buildings.
16. IS 1950 : 1962 Code of Practice for Sound Insulation of Non-Industrial Buildings.
17. IS 2212 : 1962 Code of Practice for Brick Work.
18. HANDRY (A W). Workmanship Factors in Brickwork Strength, BDA Technical Volume 1, No. 6; 1973.
19. THOMAS (K) and KERFF (JOA). Design of Free Standing Brickwalls. BOA Technical Note Volume 1, No. 5; July 1972.
20. DIN 1053/1 Brick Calculation and Construction Deutsche-1974.

PART 2
MASONRY CONSTRUCTION
PRACTICE

As in the Original Standard, this Page is Intentionally Left Blank

SECTION 1

1 GENERAL**1.1 Introduction**

Masonry is one of the main items of construction in a building and needs careful consideration. It comprises masonry units such as brick, stone, concrete block laid in mortar. There is a large variety of units and a number of different types and grades of mortars that are used in masonry. Architects and Engineers should have good knowledge of properties of units and mortars so as to be able to choose an appropriate combination of the two, to meet the requirements for a particular situation. Similarly, field engineers should have good knowledge of the construction practices and techniques so that masonry effectively serves the purpose for which it is intended.

1.2 Materials**1.2.1 Specifications**

Materials used in masonry are covered, with regard to their specifications, in a number of Indian Standards as given in the List of References and Bibliography at the end. Information in a summarised form could be found in "SP : 21 Summaries of Indian Standards for Building Materials".

1.2.2 Stacking and Storage

1.2.2.1 It is necessary that materials for construction are stacked and stored at site in a planned manner so as to minimise chances of deterioration and to facilitate subsequent handling for construction. Detailed recommendations in this regard are contained in 'IS 4082 : 1977 Recommendations on Stacking and Storage of Construction Materials at Site'. Summary of recommendations (with minor modifications) relating to materials commonly used in masonry namely, cement, lime, bricks, concrete blocks and aggregates are given in the following clauses.

1.2.2.2 As a general principle, materials should be stacked/stored at site such that: (a) these are not damaged by rain, humidity, wind and dust storm; (b) lead for subsequent handling of those materials is minimum; (c) it should be possible to make use of and exhaust stocks of materials received earlier, before starting use of freshly arrived material; and (d) it is easy to take stock of

the quantities available at site from time to time for the purpose of inventory control.

1.2.2.3 Cement

Cement if received in gunny bags should be stored in a building or temporary godown which is dry, leak-proof and moisture-proof. Cement bags should be stacked off the floor on wooden platform about 15 cm clear above the floor and a space of about 45 cm should be left around between the walls and stacks. Height of stacks should not be more than 15 bags and width not more than 4 bags length. When height of stacks exceeds 8 bags, these should be placed alternately in header and stretcher layers so as to avoid toppling over. As an additional precaution during monsoon season, bags should be covered with tarpaulins or some waterproof sheets and windows (if any) and doors should be kept closed.

1.2.2.4 Lime

Quicklime should be slaked soon after its arrival and should be stored on a dry brick platform in the form of compact heaps suitably protected from rain and storm. During rains slaked lime should be stored under a shed. Hydrated fat or semi-hydraulic lime received in bags should be stored in godown or shed on dry brick platform, while hydrated hydraulic lime in bags should be stored in a godown on wooden platform just like bagged cement.

1.2.2.5 Bricks

Bricks should be stacked on dry firm ground, stacks being generally 50 bricks in length, 2 to 4 bricks in width (placed lengthwise) and 10 bricks in height, placing the bricks on edge. Clear spacing between stacks should be 0.8 m or more.

1.2.2.6 Concrete blocks

Concrete blocks should be stacked at site so that stacks are about 1 m high and each stack contain a truck load (or its multiple) of the material. It is very necessary to prevent the blocks from getting wet before use; if there is a possibility of occurrence of rain, either the blocks should be covered with tarpaulins or stacking of blocks should be done under a leak-proof shed.

1.2.2.7 Aggregates

Aggregates should be stored in regular stacks on a dry, hard and level patch of ground such that aggregates do not get admixed with soil, and other foreign matter. Sufficient space should be left between stacks of different types of aggregates to prevent intermixing. Special precautions are necessary in case of fine aggregates to prevent the same from being blown away by wind.

1.3 Masonry Units

1.3.0 As mentioned earlier there is a large variety of masonry units from which an architect or engineer can choose the one most suited to a particular situation. Main considerations in choosing particular a unit are: availability, strength requirement, durability, dimensional stability and resistance to rain penetration, fire rating, thermal properties, style of architecture and economy in cost. Physical characteristics and properties of various units are detailed in relevant Indian Standards (*see* List of References and Bibliography at the end of this Part). Physical characteristics of different units in common use are summarized in Table 1. The more important features are briefly given below.

1.3.1 Common Burnt Clay Brick

Brick is one of the most commonly used unit for masonry and whenever brick of acceptable quality and desired strength is available locally, it is generally the unit of first choice. It has practically most of the desirable characteristics of a masonry unit namely strength, durability, dimensional stability, good thermal performance, good fire rating and economy in cost. Compressive strength of brick depends on type of soil used for moulding brick, method of moulding, technique of burning, etc. In India, strength of common brick generally varies between 2.5 to 25 N/mm².

1.3.2 Heavy Duty Burnt Clay Building Brick

This brick, also known as 'Engineering Brick',

Table 1 Physical Characteristics of Masonry Different Units
(Clause 1.3.0)

Sl No.	Nomenclature	Density kg/m ³	Standard Dimensions (Actual) L × B × H cm	Com- pressive Strength N/mm ²	Water Absorption Percentage (By Weight)	Drying Shrinkage Percent- age	Moisture Move- ment Percent- age	Remarks	Reference to Indian Standard
(1)	(2)	(3)	(4)	(5)	(6)	(7)	(8)	(9)	(10)
1.	Common burnt clay building brick	NS	19 × 9 × 9 19 × 9 × 4	3.5-35	≥ 20 up to class 125 ≥ 15 for higher classes	NS	NS	Used for all general building construction	IS 1077 : 1976
2.	Heavy duty burnt clay brick	≤ 2 500	do	≤ 40	≥ 10	NS	NS	Used for heavy engineering works	IS 2180 : 1970
3.	Sewer brick	NS	do	≤ 17.5	≥ 12	NS	NS	Used for sewer construction	IS 4885 : 1968
4.	Burnt clay perforated building brick	NS	19 × 19 × 9 29 × 9 × 9	≤ 7.0	≥ 15	NS	NS	This unit is lighter in weight and has better thermal insulation than common burnt clay brick	IS 2222 : 1979
5.	Burnt clay hollow block for walls and partitions	NS	19 × 19 × 9 29 × 9 × 9 29 × 14 × 9	≤ 3.5 on gross area	≥ 20	NS	NS	This unit is lighter in weight and has better thermal insulation than common burnt clay brick	IS 3952 : 1978

(Continued)

Table 1—Continued

(1)	(2)	(3)	(4)	(5)	(6)	(7)	(8)	(9)	(10)
6. Stone		NS							IS 1597 (Part 1): 1967
a) Granite			Refer Section 3	< 100	> 5				IS 1597 (Part 2): 1967
b) Basalt				< 40					
c) Sandstone				< 30					
d) Limestone				< 20					
7. Precast stone block									There is no IS Standard yet for this Refer CBRI Build- ing Research Note No. 7
8. Laterite stone block	< 2 500	39 × 19 × 19 49 × 19 × 19 59 × 29 × 19	< 3.5 N/mm ²	> 12		NS	NS	Used in mas- onry like coursed stone masonry	IS 3620 : 1979
9. a) Concrete masonry block— hollow	Grade A: L-39, 49 < 1 500 Grade B: B-49, 74 and C: 99, 149 less than 1 500 but < 1 000	L-39, 49 and 50 B-49, 74 99, 149 199, 249 299 H-19 and 9	Grade A: > 10 Minimum 35, 45, 55 & 70 Grade B: 20, 30 & 50 mini- mum Grade C: < 15			> 0.1	> 0.9	Hollow blocks of grade A & B are used for load bearing walls and of grade C for partitions	IS 2185 (Part 1): 1979
b) Concrete masonry blocks- solid	< 1 800	L-39, 49 and 50 B-49, 74 99, 149 199, 249 299 H-19 and 9	Grade D: > 10 Minimum 4.0 & 5.0			> 0.1	> 0.09	Solid blocks of grade D are used for load bearing walls	IS 2185 (Part 1): 1979
10. Light weight concrete block	> 1 600	39 × 30 × 19 39 × 20 × 19 39 × 10 × 19	< 28 on gross area	> 25		> 0.06	> 0.05	Used for walls and partitions	IS 3590 : 1966
11. Auto-claved cellular concrete blocks	Varying between 451 and 1 000	L-49 or 50 B-9, 14, 19, 24 H-19, 24 and 29	Grade 1: NS 10-70 Grade 2: 15-60			> 0.05 for grade 1 and 0.1 for grade 2	NS		IS 5482 : 1969
12. Lime-based block	< 1 000	L-39 B-10, 20 and 30 H-9 and 19	35	NS		> 0.1	> 0.05	Block could be solid or hollow and is used for load bearing, non-load bearing and panel walls	IS 3115 : 1976
13. Sand-lime brick	NS	19 × 9 × 9 19 × 9 × 4	7.5, 10.0, 15.0 and 20.0	NS		> 0.025 for class 75 and 100 > 0.035 for class 150	NS	Used for masonry just like common burnt clay bricks	IS 4139 : 1976

(Continued)

Table 1—Concluded

(1)	(2)	(3)	(4)	(5)	(6)	(7)	(8)	(9)	(10)
14. Soil-cement block	NS		19 × 9 × 9 19 × 9 × 4 29 × 19 × 9	≤ 2.0 for 15 class 20 ≤ 3.0 for class 30		NS	NS	Used in masonry for lightly loaded low cost buildings	IS 1725 : 1982
15. Non-load bearing gypsum partition block (solid and hollow)	NS		Length-70 maximum, in multiples of 10 Breadth-75 to 150 in multiples of 25 Height-30 maximum, in multiples of 10	≤ 5 on gross area	NS	NS	NS	Used for non-load bearing partitions in dry situations	IS 2849 : 1964

Legend : L = Length; B = Breadth; H = Height; NS = Not specified; > = Not more than; < = Not less than.

is characterised by high durability, low water absorption and high compressive strength, and is used in heavy civil engineering works such as bridge structures and industrial foundations.

1.3.3 Sewer Brick

This brick has strength and other characteristics in-between those of common brick and heavy duty brick and is intended for use in sewer construction where higher standard of durability than common brick is needed, because of the aggressive action of sewage.

1.3.4 Burnt Clay Perforated Building Brick

This unit has the advantage over common brick of lightness in weight and better thermal insulation. It is, therefore, used in load bearing walls as well as non-load bearing partitions and panels, when better thermal insulation and/or lightness in weight are required.

1.3.5 Burnt Clay Hollow Block

This unit is similar in properties and use to perforated brick, except that, percentage of voids is higher and thus masonry constructed with this unit is much lighter in weight. Its compressive strength is however low and thus this unit is mainly used for non-load bearing walls.

1.3.6 Stone

In stone masonry, dressing of stone entails lot of labour and time. Therefore, in regions where stone as well as brick is available latter is preferred. Stone as a masonry unit is made use of when brick is either not available or is more costly. As it is more expensive to dress stone to small size units, thickness of stone walls is generally kept more than what is needed from

structural and other considerations. Therefore, self-load of stone masonry is high and consequently space efficiency is low. For this reason, use of stone masonry is normally restricted to 2 or 3 storeyed buildings and where possible use of stone in partitions and panel walls is avoided.

Since water absorption of stone (about 1.5 percent) is very low as compared to that of brick (about 20 percent), stone masonry is much more durable, particularly in damp locations. Where both brick and stone are available at reasonable cost and ground water table is very high, it is advantageous to provide stone masonry in walls up to plinth level and brick masonry in superstructure.

1.3.7 Precast Stone Block

As mentioned earlier, one of the drawbacks in the use of stone in masonry is that walls have to be thicker than what is necessary from structural and other considerations. This drawback can be overcome by combining stone pieces and lean cement concrete to form precast blocks of regular size and shape—an innovation of Central Building Research Institute, Roorkee. By using precast stone blocks in place of stone, it is possible to construct walls of much lesser thickness, which results in economy in cost of construction and improvement in space efficiency. For detailed information regarding manufacture, properties and use of this unit, a reference may be made to Research Note No. 7 of CBRI:

1.3.8 Laterite Stone Block

Laterite, a weathered product of some type of rock, is capable of being cut easily into blocks of regular shape and size, suitable for masonry walls.

Therefore, in those parts of India, where laterite formation is met with, at or close to surface, simple low cost buildings can be constructed economically with the use of laterite blocks. However, because of low compressive strength and wide variation in quality of this material, use of this masonry unit is generally confined to single storeyed buildings of small spans and light loads.

1.3.9 Cement Concrete Block

In areas where brick or stone of suitable quality for masonry is not available at reasonable cost, but aggregates of quality suitable for manufacturing concrete blocks are available, cement concrete block can be used as a masonry unit for load bearing walls, partitions and panel walls. Concrete block could be solid or hollow depending on strength requirement. Concrete block has much lesser dimensional stability than clay brick and stone, special care in the use of this unit is, therefore, needed in order to avoid or minimise cracks in masonry built with this unit.

1.3.10 Light-weight Concrete Block

This unit is manufactured from light-weight aggregates with the object of reducing dead load. It has better thermal insulation than brick, stone and normal concrete but has lesser strength. It is, therefore, mainly used for non-load bearing partitions, when for structural reasons it is considered necessary to reduce dead load. This unit, like concrete block, has low dimensional stability and special care in its use is needed.

1.3.11 Auto-claved Cellular Concrete Block

This unit, in its characteristics, performance and use is similar to light-weight concrete block. For the manufacture of this unit, lightness in weight is achieved by introducing some gas in the material through chemical action.

1.3.12 Lime-based Block

This unit is similar in characteristics and use to cement concrete block but its strength is somewhat low. Choice between this unit and cement concrete block depends on considerations of availability, strength requirement and relative economy.

1.3.13 Sand-lime Brick

Characteristics of this unit are more or less similar to that of common burnt clay brick. In areas where neither soil suitable for burning brick nor stone suitable for masonry, nor aggregates for making concrete block are available, but lime and siliceous sand are readily available, one could go in for this type of unit. The unit can be manufactured to any desired strength between 7.5 to 20.0 N/mm² depending on the requirements. This unit has better dimensional stability than concrete block and lime-based but is inferior to brick and stone in this respect.

1.3.14 Soil-cement Block

Use of this unit is made mainly in low cost buildings, when soil (available locally) is suitable for manufacturing the unit and economy in cost is a primary consideration.

1.3.15 Non-load Bearing Gypsum Block

This unit is suitable for use in internal partition walls and dry locations. It has low self-weight and high thermal insulation. Use of this unit in masonry will prove to be economical and advantageous mainly when gypsum is locally available.

1.4 Mortar

1.4.1 General

Mortar is an intimate mixture with water of a binder such as cement or lime and some inert material such as sand, crushed stone, in the form of a smooth paste. In masonry, mortar has an important role to play and that is to bind the units together into one mass, in order that masonry may effectively perform its functions. Various types of mortars in common use are: mud mortar, lime mortar, cement mortar, cement-lime mortar and lime-pozzolana mixture mortar. Composition, properties and methods of preparation of various types of mortars are as follows.

1.4.2 Materials for Mortars

Materials used for making mortars are: (a) binder such as clay, lime, cement; (b) inert material such as sand, crushed stone; (c) pozzolana such as fly ash, burnt clay/surkhi; (d) lime pozzolana mixture; and (e) plasticizers. Most of these materials are covered by Indian Standards (see References).

1.4.3 Properties of Mortars

Properties of mortars which are sought for use in masonry are: workability, water retentivity, rate of stiffening, strength, resistance to rain penetration and durability. These properties have been discussed below explaining their effect on masonry. Choice of masonry mortar is governed by several considerations such as type of masonry unit and its properties, degree of exposure to weather and environments, strength requirements, etc.

1.4.3.1 Workability

Workability is the property of mortar which enables it to be spread and applied to masonry unit with ease. It also facilitates proper filling of joints in masonry. A good mortar would hang from the trowel and will flow down readily when lightly jerked. This property of mortar depends on properties of various ingredients used for making mortar and on the method of mixing adopted. As a general rule, a mud mortar prepared from fine clay soil has better workability than one prepared from sandy soil and a lime mortar has a better

workability than cement mortar. Lime when used in the form of putty, gives better workability than when used in dry hydrated form. Also grinding of lime mortar in a mortar mill, results in improved workability. When using dry hydrated lime in mortar, it is desirable to soak lime in water before mixing with sand in order to improve its workability. When mortar is made by mixing dry hydrated lime and sand without pre-soaking of lime, workability can be improved somewhat, by keeping the mixed mortar in a covered heap for about 12 hours before use. This process, known as maturing, allows particles to swell up time to time. A mortar made from well graded sand has better workability than one made from ungraded sand. Cement mortar made with ungraded coarse sand has poor workability, particularly when mix is lean and sand used is angular. Workability of such a mortar can be improved by either adding lime or chemicals known as plasticizers.

To some extent workability depends upon consistency of mortar which is measured by recording depth of penetration of a standard cone as detailed in IS 2250 : 1981. That Standard recommends following values of depth penetration for different purposes:

For laying walls with solid bricks—	90-130 mm
For laying perforated bricks	— 70-80 mm
For filling cavities	—130-150 mm

As a general principle, when joints are thin or units have high suction, consistency should be more and when units are heavy and have low suction, consistency should be less. A good craftsman adjusts the consistency of mortar by varying the quantity of water through his experience.

Composite cement-lime mortars are well known for their good workability and have some other desirable properties as discussed later in 1.4.3.5.

1.4.3.2 Water-retentivity

Most of the masonry units have normally appreciable suction, depending on their porosity and moisture content and they begin to suck moisture from mortar as soon as these come in contact with mortar. If units draw out too much moisture from the mortar rapidly, the latter is unable to gain adequate strength, when gain of strength is dependent on the process of hydration in mortar. Thus, when binder used is portland cement or hydraulic lime, it is necessary that mortar should not part with its moisture readily by suction—that is mortar should have good water retentivity. As a general rule, lime mortar and cement-lime mortar have good water retentivity while plain cement mortar made with coarse ungraded sand has low water retentivity. Water retentivity of cement mortar is improved by the addition of hydrated lime or finely ground limestone or chemical compounds known as plasticizers. Generally speaking, mortars having good workability have also good water retentivity.

A standard test for determination of water retentivity in masonry mortars is given in IS 2250 : 1981. In accordance with that standard water retentivity of masonry mortar should not be less than 70 percent. It may be clarified that property of water retentivity in masonry mortars is important mainly when masonry units have high rate of suction—as for example, common burnt clay brick and concrete block. In case of engineering brick and hard stone, which have low suction, high water retentivity of mortar does not have much advantage. In case of common brick which has water absorption of about 20 percent, suction rate of units is reduced by pre-soaking or pre-wetting of the units. In case of concrete blocks and such other units, which have very high shrinkage rate, pre-soaking or prolonged pre-wetting is likely to result in extensive cracking of masonry due to drying shrinkage and therefore pre-wetting has to be done on a restricted scale and a mortar with high water retentivity (85 percent or more) should be chosen for such masonry (see also 6.3 of Part 1).

1.4.3.3 Rate of stiffening

Stiffening of mortar in masonry is caused either by loss of moisture or by the setting action of binder used in the mortar or by both. Most of the moisture lost is absorbed into the masonry unit but some evaporates into the atmosphere. A mud mortar stiffens only by loss of moisture and there is no setting action of its clay. A lime-sand mortar made from non-hydraulic lime (limes of grade C and D) also stiffens in early stages by loss of moisture but it has also very mild and slow setting action due to carbonation. A cement mortar stiffens mainly through setting action of cement. Behaviour of a cement-lime mortar is in-between that of lime mortar and cement mortar. It is necessary that mortar should have sufficiently high rate of initial stiffening so that construction work could proceed at a reasonable pace. If rate of stiffening is too low, mortar, due to its plasticity will get compressed and squeezed out, as the work proceeds, due to self-load of masonry, thus resulting in variation in thickness of joints and distortion of masonry. On the other hand, if rate of stiffening is too rapid, it will result in cracking masonry as the unavoidable shrinkage in units due to drying and slight settlements in foundation due to loads, cannot then be accommodated within the mortar joints.

In cold regions, when nights are frosty, it is important that mortar should stiffen rapidly enough so that it is not damaged by frost by formation of ice crystals within the body of mortar. For this reason, as a general rule, cement mortar should not be leaner than 1 : 5 and cement-lime mortar leaner than 1 : ½ : 4½. In addition, some further precautions like preventing masonry units, sand and water from getting too cold, use of warm water for mixing of mortar, use of calcium chloride as an accelerator in cement mortar, covering the freshly laid masonry with

tarpaulins at the close of the day's work, etc, should be taken.

1.4.3.4 Strength

A mortar gains strength, to a small extent by loss of moisture that is by drying action as in mud mortar and non-hydraulic lime mortar, but mainly by setting action of its cementitious content, namely lime and cement. In case of lime mortar made from non-hydraulic lime, which sets through carbonation, gain of strength is very slow. In case of cement mortar or lime mortar made from hydraulic lime, gain of strength is due to hydration and is comparatively rapid. From structural considerations it is necessary that masonry should attain the requisite strength by the time loads are imposed on it. With that in view, 28-day strength of a mortar is taken into consideration.

As stated earlier, mud mortar stiffens only by loss of moisture and its constituents, namely soil has no setting action. It softens again on absorbing moisture and is easily eroded by rain. It has, therefore, very low strength and poor durability. For this reason, mud mortar is considered suitable only for use in superstructure of temporary or semi-permanent buildings with very light loadings. When mud mortar is used in brick or stone masonry, basic stress in masonry should be limited to 0.2 N/mm^2 and to prevent erosion due to rain, external face of walls should be protected either by lime/cement pointing or some form of non-erodible plaster. Mud mortar should not be used in moist or wet situations for example, foundations of a wall. This mortar is also not suitable for use in areas infected with white ants.

Strength of masonry, *inter-alia*, depends on strength of mortar. It is however, to be kept in mind that undue importance should not be attached to strength of mortar at the cost of other properties of mortar. Mortar need not, therefore, be stronger than what is necessary from consideration of strength of masonry, and it should possess other desirable properties. High strength mortar has an advantage only in case of high-strength units, and heavy loads.

Ordinarily in buildings designed as per provisions of Design Standard Codes, slenderness ratio of load bearing elements is restricted so that due to over-loading, failure of masonry would take place by tensile splitting of masonry and not by buckling. Therefore, bond between mortar and masonry is more important than compressive strength of mortar. Use of composite cement-lime mortar, because of its better bond strength, gives a stronger masonry than that with plain cement mortar, even though plain cement mortar may have higher compressive strength.

1.4.3.5 Resistance to rain penetration

Rain water penetrates a masonry wall by three different modes, namely: (a) through pores of

masonry units, (b) through pores of mortar, and (c) through cracks between units and mortar. It has been found that rain penetration through units and mortar is not very significant and main source of rain penetration is through cracks in masonry. Moreover, rain penetration is much more through wide cracks, even if few in number, than through thin cracks which may be more in number. These cracks are mostly caused by shrinkage of units and mortar on drying, thermal movement of units and mortar and inevitable slight settlement to which every building is subject. Thus, from the view-point of rain penetration, bonding property of mortar is of great importance. It has been observed that if mortar is not very strong, if it gains strength slowly, and if it has good bond with units, movement of units due to shrinkage, temperature variations and settlement of foundation get accommodated to a great extent within the mortar and cracks are, therefore, thin and evenly distributed. As a result, masonry has much better resistance to rain penetration. A composite cement-lime mortar possesses practically all the above mentioned desirable qualities. In this mortar relative proportion of cement and lime is varied to suit the strength requirement of masonry and shrinkage coefficient of units. For units having high shrinkage for example, concrete block, lime content should be ample. Mixes of composite mortars in common use are $1:1/2:4 1/2$, $1:1:6$, $1:2:9$ and $1:3:12$. Of these 4 mixes $1:1:6$ mix is in more common use since it has reasonably good strength and also, imparts to masonry, adequate resistance to rain penetration.

1.4.3.6 Durability

Deterioration in mortar takes place due to: (a) frost action before the mortar has gained sufficient strength, and repeated cycles of freezing and thawing, (b) prolonged chemical action between soluble sulphates present either in burnt clay bricks or in soil in contact with masonry in foundation, and (c) ingress of moisture through cracks into the body of the masonry and consequent repeated cycles of wetting and drying over a number of years and crystallization of salts.

For protection against frost damage, and repeated cycles of freezing and thawing, it is necessary that mortar should gain strength rapidly, it should be dense and should have good ultimate strength. It should therefore, contain adequate proportion of portland cement, and sand should be well graded. Since lime mortar is slow in setting, and does not have much ultimate strength, its use is not suited when there is early frost hazard or when masonry is likely to be subjected to repeated cycles of freezing and thawing. Use of an air-entraining admixture in cement mortar $1:5$ or $1:6$ considerably improves its resistance to frost action and repeated cycles of freezing and thawing.

For protection against sulphate attack, a rich

cement mortar (1:4 mix or better) or composite cement-lime mortar 1:½:4½ using ordinary portland cement should be used when only moderate protection is needed and rich cement mortar (1:4 or better) with sulphate resisting cement should be provided when sulphate attack is expected to be severe. It should be borne in mind that if masonry in any situation remains generally dry, sulphates, even if present in brick or sand in excessive quantity, cannot cause much damage.

To ensure durability of mortar against weathering action due to repeated cycles of wetting and drying of masonry (for example, parapets) in exposed situations, mortar should be dense and moderately strong. For this mortar should be either 1 cement:5 sand or 1 cement:1 lime:6 sand using well graded sand. Further, properties of mortar should match the type of unit used in masonry, so that there are no wide cracks in masonry. For example, when using units having high shrinkage such as concrete blocks, cement-lime mortar should be used since this mortar, being slow in gaining strength, permits volumetric changes in units within the mortar joints without occurrence of wide cracks and has good resistance to rain penetration. Use of some air-entraining admixture in cement mortar also improves its durability quite appreciably.

1.4.4 Preparation of Mortars

1.4.4.1 Mud mortar

Soil for mud mortar should have clay and silt content—60 to 70 percent and sand content—40 to 30 percent. It should be free from vegetation, organic matter, gravel, coarse sand and should not contain excessive quantities of soluble salts. Selected soil should be placed in regular stacks of about 30 cm height, with raised edges. Size of stack should be regulated so that mortar obtained is adequate to meet a day's requirement. Enough water should then be added so as to soak the entire soil. After 12 to 24 hours, it should be worked up with a 'phowrah' and trodded over with bare feet so as to form a thick paste, adding more water if necessary and removing all clods, stones, roots, etc. If during course of use, the mortar becomes stiff due to loss of moisture by evaporation, more water should be added and mortar retempered.

If use of soil containing excessive soluble salts is unavoidable, salts should be leached out from the soil, by adding sufficient water daily to the soil stack, once or twice, for about a week and letting the water drain out from the sides of the stack. If soil containing excessive salts is used in mud mortar without leaching, the mortar will not have much binding quality.

1.4.4.2 Lime mortar

- a) *Supply of lime* — Hydraulic lime is normally supplied as hydrated lime in bags, but it could be supplied as quicklime in

lumps or in ground form when so required. Semi-hydraulic and non-hydraulic lime are generally supplied as quicklime, but these are also available as hydrated limes in bags. Kankar lime is supplied either as quicklime in lumps or as ground quicklime in bags. When lime is supplied as quicklime, it should be slaked as soon as possible (preferably within 7 days) since it deteriorates in quality due to on slaking if kept unslaked. Quicklime should be stored when storing is unavoidable, in compact heaps under cover from rain so that its exposed surface is minimum.

- b) *Slaking of lime* — There are basically two methods of slaking of quicklime at site, namely, 'tank slaking' and 'platform slaking'. In the latter method, there are some variations depending on type of lime, that is hydraulic, non-hydraulic, dolomitic or kankar. These methods have been described below:

- 1) *Tank slaking* — This method of slaking is adopted in case of semi-hydraulic and non-hydraulic calcium lime. It is not suitable for slaking hydraulic, dolomitic and kankar lime because, firstly, these limes, being slow in slaking, do not slake properly by this method and secondly, hydraulic and kankar limes lose their strength rapidly due to excess of moisture. In case of semi-hydraulic and non-hydraulic calcium lime, this method has the advantage over the other method of slaking, namely platform slaking that hydrated lime obtained is in the form of putty, free from any impurities and unhydrated particles, and mortar made from lime in puttyform has good workability.

For this method of slaking, there should be preferably two tanks of suitable sizes, the first one at a raised level of 40 to 50 cm depth, so that its contents could flow by gravity to the second tank of 75 to 80 cm depth, at a lower level. The upper tank is filled with water up to about 25 cm depth and quicklime broken to small lumps of 5 to 10 cm size is added to the tank to cover the entire bottom of the tank up to about half the depth of water. Care should be taken to ensure that no part of lime is exposed above water. As soon as quicklime comes in contact with water, it begins to slake with evolution of heat and rise of temperature. Pace of feeding of quicklime to tank is so adjusted that near-boiling temperature is maintained. Contents of the tank are constantly hoed and stirred to promote slaking. After the slaking has apparently ceased, hoeing and stirring is continued for sometime

more to ensure complete and thorough slaking. Lime in slurry form is then run down, through a sieve of IS designation 2.36 mm, to the lower tank, where it is allowed to mature and thicken so as to form putty. Period of maturing should be 1 to 2 days in case of semi-hydraulic lime and not less than 3 days in case of non-hydraulic lime.

In case, a continuous supply of lime putty is desired, there should be two low-level tanks, to be used alternatively. On small jobs, the lower tank could be dispensed with and slaking of lime and its maturing to form putty could be carried out in one tank.

Lime, putty should not be allowed to dry before use, and when kept in storage, it should be completely covered with a layer of water. Putty of non-hydraulic lime could be kept in storage up to 2 weeks, without any risk of deterioration in quality but putty of semi-hydraulic lime should be used within 1 or 2 days.

- 2) *Platform slaking of semi-hydraulic and non-hydraulic calcium limes* — Quicklime is broken to about 5 to 10 cm size and is spread in a 15 cm thick layer on a water-tight masonry platform. Water is then sprinkled over it intermittently, overall quantity of water used being approximately 60 percent by weight of the quantity of quicklime. It is necessary to regulate the quantity of water carefully through experience, so that after slaking, hydrated lime is in the form of dry powder. If excess water is used, hydrated lime will not be in dry powder form and if less water is used, slaking will not be complete. To ensure thorough and complete slaking, lime should be, at intervals, hoed and turned over adding more water if necessary. When slaking activity has apparently ceased, the slaking process should be allowed to continue by itself for a further period of one or two days. Slaked lime should then be screened through a sieve of IS designation 3.35 mm and hydrated lime kept stored in a compact heap, suitably covered with a tarpaulin or a layer of dry bricks to protect it from wind, dust and rain. It is desirable to use lime after slaking as soon as possible but within 7 days, since it deteriorates in quality due to contact with air.
- 3) *Platform slaking of hydraulic lime* — Hydraulic lime slakes rather slowly and therefore, before slaking the lumps should be broken to pieces of size 5 cm and below. In fact, if lime is very refractory, it should be ground to a coarse powder so as to ensure good

slaking. Quicklime should be heaped on a water-tight masonry platform and water to the extent of about 30 litres per quintal sprinkled over the heap and mixed with lime so that all lumps or pieces of quicklime get thoroughly wetted. The heap should then be covered all over with a layer of measured quantity of sand 5 to 8 cm thick in order to conserve heat of hydration and the heap left undisturbed for 36 hours. After this, lime along with sand should be screened through a sieve of IS designation 6.3 mm. When using this hydrated lime, quantity of sand used for covering the heap should be taken into account while proportioning lime and sand. This lime should be stored in a compact heap and protected from moisture and rain. It should be used as soon as possible within 7 days. If limestone has been burnt at high temperatures, it cannot be properly slaked at site, and pressure slaking in an autoclave becomes necessary.

- 4) *Platform slaking of dolomitic lime* — Slaking procedure of this lime is similar to that of hydraulic lime. However, the quantity of water used should be 40 litres per quintal and the heap should be left undisturbed for 2 to 3 days. Thereafter, it should be screened, stored and proportioned just like hydraulic lime. In case of this lime also, pressure slaking is needed when limestone has been burnt at high temperature.
- 5) *Slaking of kankar lime* — Since kankar lime contains a large proportion of impurities, it is very slow in slaking. This lime has, therefore, to be ground to a coarse powder before slaking. Procedure for slaking of this lime is similar to that of hydraulic lime. However, no sand should be added as cover during slaking and the quicklime after wetting and turning over, should be left in the form of a compact heap for 2 to 3 days for slaking.
Alternatively the process of slaking and wet grinding to form mortar could be combined and carried out in mortar mill as in 1.4.4.2(e)(6).
- c) *Use of hydrated lime in mortar* — When semi-hydraulic and non-hydraulic limes have been supplied at site in hydrated form or these have been slaked on a platform at site, it is desirable to soak lime in water for some time before use, so as to ensure proper workability of mortar. Soaking should be for a minimum period of 16 hours in case of non-hydraulic lime and for 8 to 12 hours for semi-hydraulic lime. Hydraulic lime should not be soaked before use since this lime

starts setting on getting wet and thus loses strength if presoaked. If lime mortar has been prepared from dry hydrated, non-hydraulic and semi-hydraulic limes, its workability can be improved by keeping it in storage for 16 to 24 hours in case of non-hydraulic lime and 8 to 12 hours in case of semi-hydraulic lime. In case however, some pozzolana has been used in the mix, the mortar should be used as soon as possible within 4 hours.

d) *Proportioning of mix* — For preparation of lime mortar, lime, in the form of dry hydrate or putty, and fine aggregate (sand and pozzolana) are proportioned by volume. Though density of lime putty varies with its age, getting denser as it ages, for all practical purposes, volume of putty is taken to be same as that of dry hydrated lime. In case of sand, it is its dry volume that is to be taken for proportioning and therefore due to allowance has to be made for its bulkage, in case the sand is moist. When lime supplied is in the form quicklime for estimating roughly, lime requirement, it may be assured that one quintal of quicklime will yield 5 standard sized bags (0.035 m³) of dry hydrated lime, after making allowance for residue and wastage. When lime used in non-hydraulic, it is necessary that at least half the volume of fine aggregate is a pozzolanic material namely, cinder, fly ash or burnt clay. Even in case of semi-hydraulic lime it is desirable to use pozzolana to the extent of at least one third of the volume of fine aggregate, so as to get better strength. Though it is not essential to use pozzolana in a mix of hydraulic lime mortar, there is no technical disadvantage in doing so if it results in saving in cost.

e) *Mixing and grinding*

1) Mixing can be done either manually in a masonry trough or in a mechanical mixer. The latter method gives much better result and is preferable. For all important jobs, mixing should therefore be done in a mechanical mixer.

2) When mixing is done manually, if lime is in dry powder form, lime and sand or lime and pozzolana and then sand should be first mixed dry. Water should then be added and wet mixing continued for some time more so as to ensure thorough and uniform mixing. When lime is in putty form, some water may be added right in the beginning, since otherwise, because of sticky nature of putty, mixing is difficult. Alternatively, lime putty and water may be first mixed in the trough to form a thin paste and then sand/pozzolana added and further mixing carried out.

3) When a mechanical mixer is used, all ingredients may be added at one time and mixing carried out for at least 5 minutes.

4) In lime mortar optimum result is obtained by grinding the mortar in a mortar mill, after dry or wet mixing of ingredients, manually or mechanically. The mortar mill could be either animal drawn or mechanically powered. The ingredients after mixing are fed into the mortar mill and grinding done, continuously raking the stuff to ensure uniform grinding, and adding more water as and when necessary. Grinding should be continued till all particles of fine aggregate are fully coated with lime and mortar is of uniform colour all through. In an animal drawn mortar mill, grinding should generally be done for 120 to 180 revolutions (2 to 3 hours) depending on nature of lime and aggregate used and quality of mortar desired. In case of mechanically powered mortar mill, grinding should generally be done for at least 15 minutes.

5) When using hydraulic lime, sometimes, as a short cut, unslaked lime in the form of small lumps or coarse powder, is fed directly into the mortar mill along with requisite quantity of fine aggregate and wet grinding is started. Thus, process of slaking, mixing and grinding take place simultaneously. Drawback of this method is that some unburnt stone also gets crushed and incorporated into the mortar mix and as a result, strength obtained from this mortar is somewhat less. It is, therefore, desirable to first slake the hydraulic lime and screen the same so as to remove unburnt stone before mixing and grinding.

6) *Kankar lime* — Mortar from kankar lime is made by grinding slaked lime in a mortar mill. Proportion of sand to be added to the mix is determined after testing lime for its calcium oxide content. When calcium-oxide content is close to the minimum limit of 25 percent, no sand is added to the mix. When lime is of very good quality, lime and sand are mixed in the proportion of 1:1.

Alternatively, mortar from kankar lime should be prepared directly from quicklime by first dry grinding quicklime in the mortar mill and then wet grinding the same, with or without addition of sand. The process of wet grinding should be continued for a minimum period of three hours to ensure thorough slaking. In this process, slaking and grinding take place simultaneously. The result,

however, is not so satisfactory as that obtained by the former method.

7) In case of small and less important jobs, it is generally not feasible to arrange a mechanical mixer for mixing and a mortar mill for grinding of mortar. In such a case, wet mixing should be continued in the mortar trough manually, for a period of at least 15 minutes so that all particles of fine aggregate get thoroughly coated with lime and mortar is of uniform colour all over. Workability and strength of such a mortar however, is not so good as that of mortar prepared by proper grinding.

f) *Storage of mortar* — As a general rule, all mortars should be used as soon as possible after preparation and mortar should not be allowed to get stiff before use. Mortars prepared from non-hydraulic and semi-hydraulic limes should be used on the same day and left-over mortar of previous day should be discarded. As an exception to this general rule, lime mortar prepared from dry hydrated lime without any presoaking should be kept stored in a covered heap before use as in 1.4.3.1, in order to improve its workability. In case of mortar prepared from hydraulic lime, it should be used within 4 hours, as otherwise, it may partly set before use.

g) *Use of pozzolana in lime mortar* — Mortar prepared from non-hydraulic lime and sand does not have much strength and is thus not suitable for masonry work, except for very light loads and temporary structures. Such a mortar depends, for its setting or hardening action on carbonation which takes place very slowly and that also mainly at the surface. Use of coarse angular sand and thorough grinding for such a mortar however, do help to promote carbonation to some extent and that way, there is some improvement in strength. Where semi-hydraulic and hydraulic limes are not available and use of non-hydraulic lime for masonry is unavoidable, strength of mortar is improved by substituting sand wholly or partly with some pozzolanic material such as fly ash, or burnt clay. Alternatively in place of lime, one of the standard lime-pozzolana mixtures, which are marketed as standardized materials (Refer IS 4098 : 1967) should be made use of as dealt with in 1.4.4.5.

1.4.4.3 Cement mortar

a) *Cement* — Types of cement normally used for masonry mortars are: ordinary portland cement, portland slag cement, portland pozzolana cement, masonry cement, sulphate resisting portland cement and super-sulphate cement, choice of cement

depending on ready availability, and requirements of rate of strength development and resistance to sulphate action, etc. As a general rule, for masonry mortars it is not desirable to use cements that set rapidly except in cold regions where early strength development is needed from consideration of frost action. Masonry cement gives a good workable mortar and being slow in strength development, masonry is much less liable to shrinkage cracks. Portland pozzolana cement is also somewhat slow in strength development and should be preferred to ordinary portland cement, when there is no need for early strength development; in addition it has better resistance against chemical and sulphate attack. Sulphate resisting portland cement and super sulphated cement are used when moderate to high resistance against sulphate attack is desired.

b) *Proportioning* — Proportioning of ingredients for mortars is normally done by volume, taking a normal bag of cement weighing 50 kgs as a standard unit of volume 0.035 cu.m. Measurement of sand is done by making use of a box of size 40 × 35 × 25 cm which has the same volume as that of a standard bag of cement. When sand used is not dry, due allowance should be made for bulking of sand, after carrying out test for bulking.

c) *Mixing* — Except on small jobs or when requirement of mortar is not much, mixing of mortar should be done in a mechanical mixer. Cement and sand in specified proportions are added to the mixer, and the two are first dry mixed till a mix of uniform colour is obtained. Water in measured quantity is then added gradually and wet mixing continued till mortar of uniform colour and desired consistency is obtained, time for wet mixing being not less than 3 minutes. Quantity of water should be regulated so that mix obtained has the consistency of a stiff paste. If mortar contains too much of water, strength of masonry will be affected. Mixer should be cleaned with water immediately after use each time before suspending the work.

For hand mixing, measured quantity of sand should be stacked over a water-tight platform and contents of a cement bag emptied and spread over it in a uniform layer. The two ingredients should be first mixed dry, by turning over and over a number of times till a mixture of uniform colour is obtained. Wet mixing of the whole or a part of the dry mix should be done either on the same platform or in a separate trough, by adding requisite quantity of water and hoeing the mix continuously for 5 to 10 minutes so that a stiff paste of uniform

colour is obtained. Care should be taken not to add excess water.

If a plasticiser is to be used in cement mortar to improve its workability, its measured quantity should be added to mixing water for the cement mortar. When lime is to be used as a plasticiser, it should preferably be a non-hydraulic lime and failing that semi-hydraulic lime. It should be either used in the form of putty added to the mix or mixing water, or as a second choice in the form of dry hydrated lime, presoaked in a trough for some time and added to the mix or mixing water, such that cement mortar contains the right proportion of lime.

As far as possible only that much quantity of mortar should be prepared at one time as can be consumed within half an hour. However, if for some reason that is not found feasible, mortar could be used up to a maximum period of 2 hours, by retempering the same, adding more water if necessary to get the desired consistency. Mortar not used within 2 hours of addition of water should be discarded.

1.4.4.4 Cement-lime mortar

There are three methods of making cement-lime mortar as given below. These methods are described in order of their preference. On large and important jobs, method one should be normally adopted. Method three should be adopted only for small and unimportant jobs. Only that much quantity of mortar should be prepared at a time, as can be consumed in 2 hours.

- a) *Method One* — Lime mortar with lime and sand in specified proportion for whole day's requirement should first be prepared from lime putty and sand by mixing in a mechanical mixer and then grinding it in a mortar mill. This mortar called "coarse stuff" is kept aside as stock and prevented from drying out. Coarse stuff and cement should then be taken in suitable proportions in batches and mixed, along with additional water in a mechanical mixer for a minimum of 3 minutes so as to obtain mortar of desired consistency and uniform colour. When ratio of lime to cement in the mix is 1 or less than 1, main function of lime in the mix is to act as a plasticiser and grinding for preparation of coarse stuff may be dispensed with.

For proportioning, volume of coarse stuff is taken to be equal to that of sand in the mix. Thus for preparing cement-lime mortar 1 cement : 2 lime : 9 sand, coarse stuff of proportion 1 : 4½ is prepared and cement and coarse stuff are mixed in the proportion 1 : 2. If on the same day, different mixes of

composite mortar namely 1 : 1 : 6, 1 : 2 : 9 and 1 : 3 : 12 are needed, coarse stuff of standard proportion 1 : 3 is prepared and additional sand is added where required at the time of mixing to cement and coarse stuff so as to obtain any desired mix. For example, when 1 : 1 : 6 mortar is to be prepared with this stock, cement, coarse stuff and sand are mixed together in the proportion 1 : 1 : 3. Similarly, for obtaining 1 : 2 : 9 and 1 : 3 : 12 mortars, cement, coarse stuff and sand in the proportion 1 : 2 : 3 and 1 : 3 : 3 are mixed.

When only a small quantity of mortar is needed, mixing of mortar could be done manually on a platform or in a trough.

- b) *Method Two* — In this method, cement and sand are taken in specified proportions and are mixed together dry in a mixer. Lime putty in specified proportion along with requisite quantity of water are then added and further mixing done till mortar of uniform colour is obtained.

When lime to be used is in the form of dry hydrated powder, it should be pre-soaked in a trough for about 16 hours in case of non-hydraulic lime and for 8 to 12 hours in case of semi-hydraulic lime, excess of water if any, decanted off from top and putty thus formed in the trough, used for making mortar, as described earlier. If mixing is to be done manually, measured quantity of lime putty and water are mixed together separately in a container and emulsion of lime thus formed (called milk of lime) added to dry mix of cement and sand and further mixing done in a trough or over a platform. Care should be taken to add only that much water as would give mortar of desired consistency.

- c) *Method Three* — In this method, cement, hydrated lime and sand in the specified proportion are first mixed dry in a mixer or on a platform and then water added and further mixing done so as to obtain a mix of uniform colour and desired consistency. Wet mixing should be carried out for a minimum period of 3 minutes in case of mechanical mixing and 10 minutes in case of manual mixing. With this method, workability of resulting mortar is not so good as that obtainable by methods one and two. This method of mixing should, therefore, be adopted only when methods one and two are not feasible from practical considerations.

1.4.4.5 Lime-pozzolana mixture mortar

This mortar is made by taking lime-pozzolana mixture and sand in specified proportions and mixing the ingredients in the same manner as cement mortar. Mortar made from lime-pozzolana mixture of type LP-20 or LP-40 as

binder, which are hydraulic should be used within 4 hours of mixing, while mortar made from lime-pozzolana mixture of type LP-7 which is semi-hydraulic should be used within 12 hours.

1.4.5 Standard Mixes

Standard mortar mixes for masonry commonly used, mainly based on Table 1 of IS 2250 : 1981 are given in Table 2.

1.4.6 Choice of Mortar

1.4.6.1 Choice of mortar is governed by several considerations such as type of structure, type of masonry units, degree of exposure to weather, nature of environment, strength requirements, etc. These considerations are briefly discussed below:

a) *Type of Structure*—Structures may be classified as permanent, semi-permanent or

Table 2 Standard Mortar Mixes for Masonry

Sl No.	Type	Mix Proportions					Minimum Compressive Strength N/mm ²
		Cement	Lime	L.P. Mixture	Pozzolana	Sand	
1.	H-1	1	0-¼ C or B	—	—	3	10
2.	H-2	1	0-¼ C or B	—	—	4	7.5
3.	H-2	1	½ C or B	—	—	4½	6.0
4.	M-1	1	—	—	—	5	5.0
5.	M-1	1	1 C or B	—	—	6	3.0
6.	M-1	—	—	1 (LP-40)	—	1.5	3.0
7.	M-2	1	—	—	—	6	3.0
8.	M-2	1	2B	—	—	9	2.0
9.	M-2	—	1A	—	—	2	2.0
10.	M-2	—	1B	—	1	1	2.0
11.	M-2	—	1 C or B	—	2	—	2.0
12.	M-2	—	—	1 (LP-40)	—	1.75	2.0
13.	M-3	1	—	—	—	7	1.5
14.	M-3	1	3B	—	—	12	1.5
15.	M-3	—	1A	—	—	3	1.5
16.	M-3	—	1B	—	2	1	1.5
17.	M-3	—	1 C or B	—	3	—	1.5
18.	M-3	—	—	1 (LP-40)	—	2	1.5
19.	L-1	1	—	—	—	8	0.7
20.	L-1	—	1B	—	1	2	0.7
21.	L-1	—	1 C or B	—	2	1	0.7
22.	L-1	—	—	1 (LP-40)	—	2.25	0.7
23.	L-1	—	—	1 (LP-20)	—	1.5	0.7
24.	L-2	—	1B	—	—	3	0.5
25.	L-2	—	1 C or B	—	1	2	0.5
26.	L-2	—	—	1 (LP-7)	—	1.5	0.5

NOTES :

- All proportions are by volume.
- Sand for making mortar should be well graded; if it is not well graded proportion of sand in the mix shall be reduced in order to achieve the minimum specified strength.
- In mixes 1 and 2, use of lime is optional, it is intended to improve workability.
- In mixes 4, 7, 13 and 19, either lime C or D to the extent of ¼ part of cement (by volume) or some plasticizer, should be added for improving workability.
- In mixes 8 and 14, lime and sand should first be ground in mortar mill and then cement added to coarse stuff.
- It is essential that mixes 9, 10, 11, 15, 16, 17, 20, 21, 24 and 25 are prepared by grinding in mortar mill.
- Mix 3 has been classed to be of same type as mix 2, mix 5 and mix 6, same as mix 4 and mixes 8 to 12 same as mix 7, even though their compressive strength is less, because on account of higher bond strength these are taken as equivalents in regard to strength of masonry.
- Use of an air-entraining admixture in mortar 4 and 7 improves its sulphate resisting property as well durability that is resistance, to frost hazard or damage due to repeated cycles of freezing and thawing.

temporary, depending on their life expectancy. Durability of mortar varies according to the type of binder used in making the mortar. Mortars for permanent buildings should have greater durability than those for temporary buildings. On this consideration, mortars used should be as under:

Permanent structures—Cement mortars not leaner than 1:6; Cement-lime mortar not leaner than 1:1:6; Lime-mortars using hydraulic lime; and Lime mortar using lime-pozzolana mixtures LP-40 and sand;

Semi-permanent structures—Cement mortar 1:7 or 1:8 depending upon quality of sand, Lime mortar using semi-hydraulic lime; Lime mortar using non-hydraulic lime in conjunction with some pozzolana; Lime mortar using lime-pozzolana mixture of type LP-7; and

Temporary structures—Semi-hydraulic lime mortar; Lime mortar using non-hydraulic lime in case semi-hydraulic lime is not available lime mortar using lime pozzolana mixture of Mud mortar Type LP-7.

- b) *Type of Masonry Unit*—Physical characteristics of units which have a relevance in regard to choice of mortar are their porosity, shrinkage co-efficient and strength. For unit of high porosity, such as common burnt clay bricks and cement concrete blocks, mortar used should have good water retentivity. Similarly, in case of units with high or moderate shrinkage co-efficients such as concrete blocks, cellular concrete blocks and sand-lime bricks, mortar used should not be very strong and should gain strength slowly. Such mortars are cement-lime mortars of mix 1:2:9 and 1:3:12 and lime mortars.
- c) *Degree of Exposure to Weather*—External walls to a moderate extent and free-standing walls such as parapets and compound walls to a great extent are exposed to weather which means rain penetration and repeated cycles of wetting and drying in areas of heavy rainfall and, frost action at night and repeated cycles of freezing and thawing in very cold climate. From consideration of rainfall and repeated wetting and drying, mortars which are slow in setting and have good bond strength namely cement-lime mortars or hydraulic lime mortars are better than plain cement mortars. Masonry subjected to night frost during construction and repeated freezing and thawing during its life span, should have greater durability than masonry which is only subjected to repeated wetting and drying. When masonry work is being done in cold climate and nights are frosty, mortar should be quick setting so

that it gains adequate strength before occurrence of frost at night. For this, cement mortar not leaner than 1:4 or cement-lime mortar not leaner than 1:½:4½ or cement mortar 1:5 with an air entraining admixture should be used and use of plain lime mortar avoided. Addition of air entraining admixture to cement mortar considerably improves its durability.

- d) *Nature of Environment*—Environments which affect choice of mortar for foundation masonry are moisture in soil in contact with masonry and presence of soluble sulphates in soil and bricks. From this consideration, mortar should be a cement mortar not leaner than 1:4 or cement-lime mortar not leaner than 1:½:4½ or cement mortar 1:5 with air-entraining admixture. When concentration of sulphates in soil is quite appreciable, sulphate-resisting cement should be used. Use of air entraining admixture in cement mortar 1:5, improves its resistance to sulphate attack.
- e) *Strength of Masonry*—To obtain desired strength of masonry, it is necessary that strength of mortar should match the strength of unit in use. No useful purpose is served in using strong mortar with units of low or moderate strength. It is not economical or sound to use mortar which is stronger than that which gives the optimum strength in masonry. Optimum mortar mixes from consideration of strength of brick masonry for bricks of various strengths are given in Table 2 of IS 1905:1987 for general guidance. Masonry should be designed in accordance with the provisions of IS 1905:1987.

1.4.6.2 Recommended mortar mixes for masonry

Table 3 for recommended mortar mixes, for different purposes is given below. One may choose a suitable mortar mix for any specific location/situation with the help of this table, keeping in view the structural requirements of masonry as per Table 10 of IS 1905:1987.

1.4.7 Miscellaneous

1.4.7.1 Retempering of mortar

If mortar gets stiffened due to evaporation of moisture before use it could be retempered for immediate use by adding water and bringing it to desired consistency within two hours of mixing in case of cement and cement-lime mortars; 4 hours in case of hydraulic lime mortar, 8 hours in case of semi-hydraulic and 12 hours in case of non-hydraulic lime mortars. As regards mud mortar, there is no time limit because it has no setting action. A mortar, other than mud mortar, which has been retempered once, should not be retempered for the second time and should be discarded.

Table 3 Recommended Mortar Mixes for Masonry

Sl No.	Situation/Location	Type of Masonry Units	Environmental/Exposure Condition	Recommended Mortar Mix ^P		
				Heavy Loads	Moderate Loads	Light Loads
(1)	(2)	(3)	(4)	(5)	(6)	(7)
1.	Foundation and plinth	Brick, stone, concrete blocks of normal density, etc	Dry subgrade with water table 1.5 m or more below subgrade	3, 4	5 to 12	13 to 18
			Moist subgrade with water table within 1.5 m of subgrade, little or no soluble salts in soils	3, 4	5, 6, 7	9, 12, 13
			Moist subgraded with moderate soluble sulphate content in soil	1, 2	3,	4, ^Q
			Moist subgraded with high sulphate content in soil	1 ^R	2 ^R	4 ^R
			Masonry is subject to early frost hazard	2,	3,	4 ^Q
2.	External walls	Brick, stone	Moderate	1 to 3	4 to 6	7 to 18
			Severe as in parapets, free standing walls, coping, sills	—	—	4 to 7
		Concrete block of normal density sand-lime brick, etc	Moderate	3	5, 6, 8 to 12	14 to 18
			Severe as in parapets, free standing walls, coping, sills, etc	—	—	5 to 12
3.	Internal walls	Brick, stone	Normal	2, 3	4 to 12	13 to 26
		Concrete block of normal density sand-lime brick, etc	Normal	3	5 to 12	14 to 18
		Light weight/cellular concrete	Normal	—	8 to 12	14 to 18
4.	External or Internal walls	Brick, stone concrete blocks, normal density, etc	Subject to early frost hazard	2	3	4 ^Q
5.	Brickwork with reinforcement	Brick	Sheltered portion exposed to weather/moisture	1, 2	2	2
				1,	1	1

^P—Recommended mortar mixes refer to corresponding mortar-mixes given in Sl. Nos of Table 2. From consideration strength, mortar should be selected in accordance with IS 1905 : 1987.

^Q—Use air entraining plasticizer as admixtures in the mortar.

^R—Use sulphate resisting cement for the mortar.

1.4.7.2 Estimating mortar requirement

As a general rule volume of mortar is taken as equivalent to volume of fine aggregates namely sand, surkhi, cinder, pozzolana, etc, used in the mortar mix. Quantity of mortar required for masonry depends on size of units, trueness of shape of units, thickness of joints and workability

of mortar. For brick masonry using bricks of size $23 \times 11.5 \times 7.7$ cm mortar requirement is about 25 percent for class A bricks and 30 percent for class B bricks. In case of bricks of size $20 \times 10 \times 10$ cm it is about 22 percent and 26 percent (for classes A and B) respectively. In case of stone masonry, it varies from 8 percent for fine ashlar

masonry to about 25 percent for coarsed rubble masonry and about 30 percent for random rubble masonry. For concrete block masonry, mortar requirement varies between 12 to 20 percent.

1.4.7.3 *Mortar additives*

Properties of cement mortar can be modified by admixing certain chemicals. The admixtures commonly used in mortars are termed as:

- i) Waterproofing compounds
- ii) Water reducing compounds or plasticizers
- iii) Air-entraining agents
- iv) Accelerators

The substances/chemicals generally used are proprietary articles and manufacturer's instructions for their use are to be followed.

- i) *Waterproofing Compounds* — These compounds are used when it is intended to improve water proofing quality of masonry as in thin external walls or linings of water tanks and water channels. Apart from proprietary materials use of crude oil to the extent of 5 percent by volume of cement makes the mortar water proof and is sometimes used for filling joints of bricks/tile pavement of roof terraces.
- ii) *Water Reducing Compounds or Plasticizers* — By addition of such a compound plasticity or workability of

mortar gets improved. Its use is advocated in case of plain cement-sand mortars 1 : 3, 1 : 4, 1 : 5, 1 : 6, 1 : 7 and 1 : 8, which otherwise would be harsh, particularly when sand used is coarse and ungraded. Use of plasticizer reduces water requirement of mortar and thus, because of reduction in water cement ratio, increases strength of mortar.

- iii) *Air-entraining Agents* — By use of an air-entraining agent in mortar, its durability, that is, resistance to freezing and thawing and sulphate attack is improved. Use of this admixture in cement mortar also gives protection to masonry against frost damage, in very cold weather.
- iv) *Accelerator* — By adding an accelerator in mortar, rate of hydration of cement is increased and consequently setting time is reduced. This helps in combating early frost hazard. Accelerator commonly employed for this purpose is calcium chloride to the extent of 1.5 to 2 percent of cement content of mortar (by weight).

1.5 Scaffolding

1.5.1 Scaffolding is a temporary structure erected during construction for supporting labour and materials in order to execute masonry and some other items of work. It is very essential that scaffolding should be strong enough and safe so that accidents do not occur due to its failure.

1.5.2 A scaffold (see Fig. 1) consists of upright

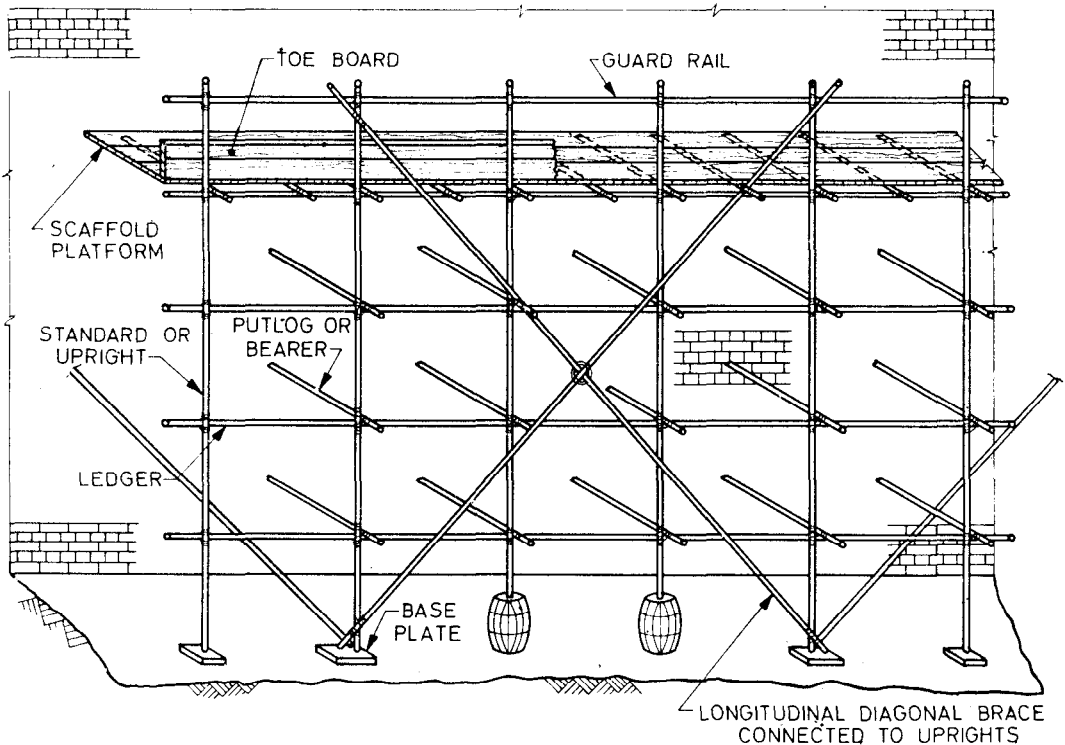

FIG. 1 TYPICAL SKETCH ILLUSTRATING COMPONENTS OF A SINGLE SCAFFOLD

members called standards, longitudinal horizontal members parallel to the wall called stringers and cross horizontal members at right angle to the wall called putlogs. Over the putlogs, planks are provided to form a platform which serves as working space for workers and stacking space for materials. In order to distribute concentrated loads from standards on the ground, these are supported on base plates of suitable size. On the other side of platform, plank on edge called 'too board' is provided to prevent falling down of materials, and also a guard rail is provided for safety of workers.

1.5.3 There are two systems of scaffolding, namely 'single scaffolding' and 'double scaffolding'. In case of the former, there is only one row of standards at some distance from the wall and putlogs are supported stringers on one end, and on wall masonry at the other. For this purpose, holes at suitable intervals are left in a header course of the masonry. In case of 'double scaffolding' two rows of standards are provided and the two ends of putlogs rest on stringers only. The scaffolding is thus more or less independent of the wall except for some ties of the scaffolding with wall or other structural members at suitable intervals, which are provided to give additional stability to the scaffolding, especially in case of tall buildings. It is necessary to go in for double scaffolding when wall has exposed brick/tile or some other decorative finish and it is obligatory to avoid holes in masonry. When using 'single scaffolding', not more than one header for each putlog should be left out, and no holes should be permitted in pillars or stretches of masonry narrower than 1 m in width, or immediately below or close to a concentrated load on masonry or near skew backs of arches. Holes left in masonry for scaffolding should be made good on removal of the scaffolding in such a way as to match the surrounding surface.

1.5.4 Sometimes, it is necessary for workmen to execute certain items of work—such as application of finish coats to external walls at a height which cannot be reached by ladders and it is not economical to go in for normal scaffolding for that purpose. In such situations, a cradle with working platform called 'jhoola', suspended by ropes from the roof terrace, is provided. The cradle is held in position or moved sideways or up and down by a few workers stationed on the terrace.

1.5.5 Depending on the nature of material used, there are two main types of scaffold, namely 'timber/bamboo scaffold' and 'steel scaffold'. Main features of the former type which is commonly used are given below. For details of latter type, IS 2250 : 1981 may be referred to.

1.5.6 Timber/Bamboo Scaffolding

1.5.6.1 Timber/Bamboo scaffolding could be either single or double.

a) *Single Scaffolding*—For single scaffolding the row of standards should be at a distance of 1.2 to 1.5 m from the wall. Standards should be 1.8 to 2.4 m apart and connected horizontally by stringers, spaced vertically at 1.5 to 1.8 m centres. Putlogs with one end resting on stringers and tied to them and the other end resting in holes in masonry, should be spaced horizontally 1.2 or less apart (usually half the spacing of standards). Nominal diameter of standards should not be less than 8 cm subject to a minimum of 5 cm at the thin end. When it is necessary to extent a standard, overlap between two standards should be at least 60 cm.

b) *Double Scaffolding*—In double scaffolding, one row of standards should be close to the wall and the other 1.2 to 1.5 m away from the wall. Nominal diameter of standards should not be less than 10 cm, subject to a minimum of 5 cm at the thin end. For extension of standards over-lapping should be done as for single scaffolding. Inside and outside scaffolding should be interconnected by cross-ledgers passing through openings in masonry with a view to obtaining better stability.

1.5.6.2 The scaffolding should be provided with diagonal bracings for stiffening it in the longitudinal direction so as to prevent its distortion. It should also be tied to the structure at suitable intervals to prevent it from leaning away from the structure. In case of a tall structure, with a view to increasing stability of scaffolding, it is desirable to embed the standards in ground to the extent of 60 cm, supported over base plates and if that is not feasible, standards may be supported in steel barrels of about 60 cm height, filled with soil which should be well rammed after filling it into the barrels.

1.5.6.3 Standards, stringers and putlogs are generally of round poles and planks for the platform are of section 20 cm × 3.5 to 4.0 cm. Ends of planks may be hooped to prevent their splitting, thus prolonging their life. Standards, stringers and putlogs could also be of sawn timber in which case their minimum sections should be 7 × 7 cm, 7 × 5 cm, and 5 × 5 cm respectively. Lashing of various members of scaffolding should be done with strong fibre ropes, applying non-slip knots. When bamboo poles are used as standards, horizontal members should be tied to the verticals just above a knot of the vertical bamboo. Toe boards and guard rails are fixed to platform/standards by nailing. Planks of the platform at their heading joints are butted, two putlogs being placed at this part about 10 cm apart to support the ends.

1.5.6.4 Scaffolding for stone masonry structures has to be stronger than that for brick masonry structures, in view of heavier weight of masonry units. This could be done by reducing the spacing

of standards and putlogs and using thicker planks for the platform.

1.6 Curing

1.6.1 Masonry mortars based on cement, hydraulic and semi-hydraulic lime, and non-hydraulic limes containing pozzolanas, depend for their setting/hardening action of hydration for which it is necessary that water used in mixing should not dry out during the process of hydration. In order to prevent early drying of moisture, all exposed faces of masonry are wetted periodically by sprinkling water over the same. The process of sprinkling water over masonry to prevent drying out is commonly known as "curing".

1.6.2 Curing of masonry should begin as soon as partial set of mortar has taken place. This would depend on type of binder used (that is whether cement, hydraulic semi-hydraulic, or non-hydraulic lime) and the ambient temperature. In hot weather, setting action is rapid, while in cold weather, it is slow. Another factor which governs the time of commencement of curing is the water retentivity of mortar. Curing of masonry using cement mortar, which has low water retentivity should be commenced early while curing of masonry using lime mortars which have high water retentivity should be commenced a little later. Broadly speaking, in hot weather, curing of masonry should be commenced within 12 hours in case of cement mortar, 24 hours in case of lime mortars made from hydraulic and semi-hydraulic limes and 36 hours in case mortars made from non-hydraulic lime. In cold weather, curing should be deferred for about 12 hours in each case.

1.6.3 Curing should be continued up to a minimum period of 7 days from date of laying of masonry. However, in case of masonry using rich cement mortar (1 : 4 or richer) when strength of masonry is a special consideration, period of curing should be extended to 10 days in dry weather (humidity less than 50 percent).

1.6.4 Frequency of curing during a day depends on ambient temperature and relative humidity. In hot and dry weather water should be sprinkled 3 times a day that is early morning, mid day and evening, in hot and humid weather or temperate and dry weather, watering should be done twice (morning and evening) and in cold weather, once a day. In case of masonry units having high shrinkage co-efficient, as for example, concrete blocks, sprinkling of water should be done sparingly so that water affects only the surface of the masonry. Excessive watering in this case is likely to cause too much of shrinkage cracking on drying.

1.6.5 Quality of water used for curing could be same as for mixing water. It should be free from organic impurities and excess of soluble salts. Chloride not exceeding 0.1 percent and sulphate

not exceeding 0.05 percent as otherwise strength of masonry may be affected or it may cause efflorescence in masonry.

1.6.6 In mud masonry, apart from drying of mud mortar and consequent hardening of mortar on this account, there is no other setting action requiring the presence of moisture. Thus, no curing is required in case of this masonry.

SECTION 2

2 BRICK MASONRY

2.1 General

Of all the masonry units, the one most commonly used in masonry is ordinary burnt clay brick. In order that brick masonry serves its purpose effectively, it is necessary that quality of materials used (brick and mortar), construction technique and workmanship should be sound. Materials used in brick masonry, namely brick and mortar have been dealt with earlier in Section 1. In the section, construction techniques and workmanship of brick masonry are discussed.

2.2 Bonds

Since masonry consists of a large number of individual units jointed together with mortar so as to form one mass, it is necessary to lay the units in such a way that, under load, the units act jointly. The most important rule to be observed in this connection is that vertical cross-joints in any course should be staggered and these should not be nearer than a quarter of brick length from those in the course below or above that course. There are a number of brick laying arrangements in vogue-called 'bonds', of which those commonly used are: 'English bond', 'Flemish bond', 'Stretcher bond', 'Header bond' and 'Quetta bond'. These are briefly described below.

2.2.1 English Bond

In this bond (Fig. 2), bricks in the facing are laid as alternate header and stretcher courses. The

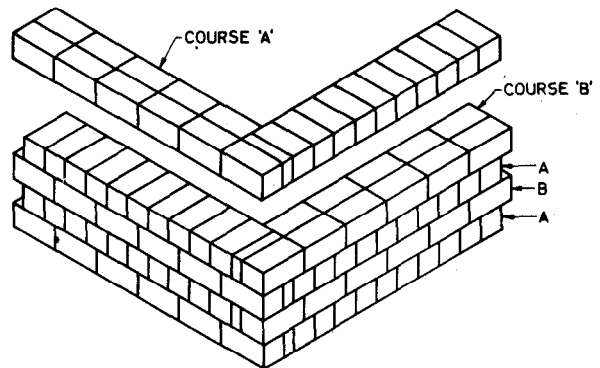

FIG. 2 ENGLISH BOND

header course is commenced with a quoin header followed by a queen closer and continued with successive headers. The stretcher course is formed of structures, having a minimum lap of one quarter brick length. This bond is considered to give the best strength in masonry and is mostly adopted in all load bearing masonry, that is to be plastered over. In this bond, when the wall is only one brick thick, one face is fair and even, while the other face may be uneven due to slight variations in length and breadth of units.

2.2.2 Flemish Bond

In this bond, in each course, headers and stretchers are used alternatively. When a course is started with a quoin header, it is followed by a queen closer to obtain desired lapping of one quarter brick length. In case of a wall which is more than one brick thick, this bond has 2 variations, namely single Flemish bond (Fig. 3) and double Flemish bond (Fig. 4). In the former, use of Flemish bond is provided only on one face while backing consists of English bond. In the latter, Flemish bond is used both in front and at the back.

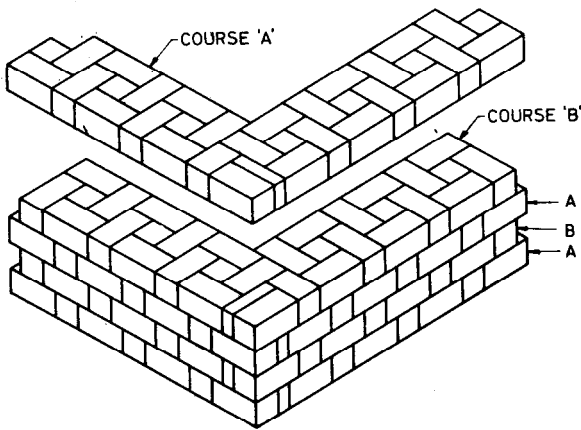

FIG. 3 DOUBLE FLEMISH BOND

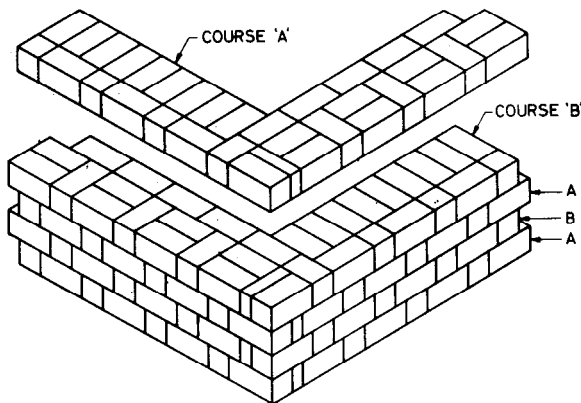

FIG. 4 SINGLE FLEMISH BOND

Flemish bond is employed mainly in exposed brick masonry because of its better appearance. When only one face of brick masonry has exposed brick finish as is generally the case, the single Flemish bond possesses the advantage of both Flemish bond (better appearance) and English bond (better strength).

In brick masonry, with special facing bricks on the external face, adoption of single Flemish bond leads to economy in the use of number of facing bricks. Sometimes, for one brick walls, that are not heavily loaded and strength of masonry is not a major consideration, Flemish bond is adopted in preference to English bond, since with this bond both faces of the wall are more or less fair and even, and therefore, plastering of those faces is less expensive.

2.2.3 Stretcher Bond

In this bond (Fig. 5) stretchers are used in all courses, with a lapping of half brick. This bond is adopted in half-brick masonry such as in partitions and cavity walls.

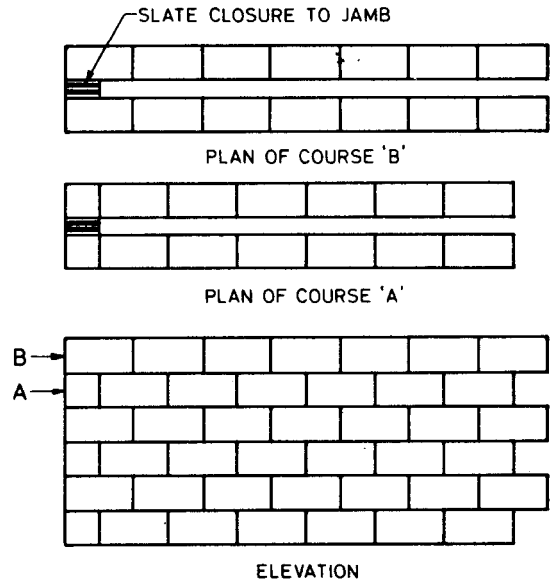

NOTE—Use of stretcher bond in cavity wall construction is illustrated here.

FIG. 5 STRETCHER BOND

2.2.4 Header Bond

In this bond (Fig. 6) only headers are used in all courses with a lapping of half-brick width. This bond is adopted in walls curved in plan for better alignment, in foundation footings of a wall for better transverse load distribution, and in corbels for better anchorage.

2.2.5 Quetta Bond

This bond (Fig. 7) is adopted when it is necessary to provide vertical reinforcement in walls for

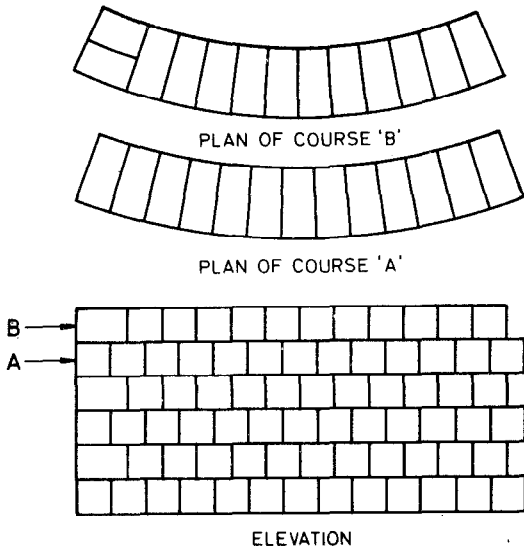

FIG. 6 HEADER BOND FOR A WALL CURVED IN PLAN

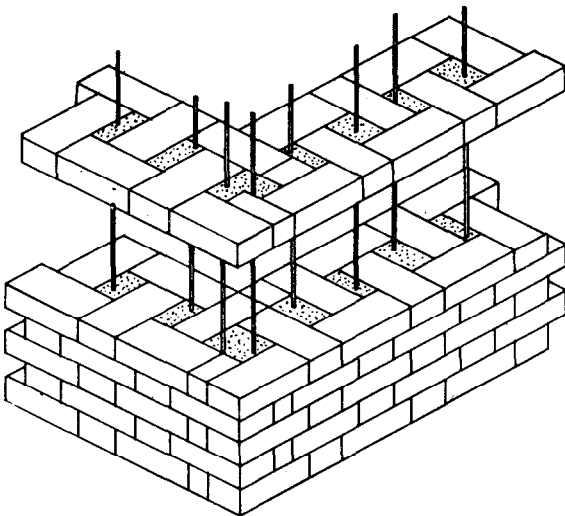

FIG. 7 QUETTA BOND

areas subjected to earth tremors. Minimum thickness of wall in this case is $1\frac{1}{2}$ bricks and both front and back elevations of the wall are similar to that of Flemish bond. With the adoption of this bond, quarter brick by half brick pockets, which are continuous through full height of the wall, are formed along the length of the wall. In these pockets steel rods are placed, and pockets are filled up with cement concrete or mortar as the work proceeds.

2.3 Laying of Brick Masonry

2.3.1 Soaking of Bricks

Bricks being porous, absorb moisture from the mortar on coming in contact with it, if these are in a dry state. This would weaken a mortar which

sets by hydration. It is, therefore, necessary that for brick masonry in mortar other than mud mortar, bricks should be soaked in water by immersion or sprinkling, before use, so that water penetrates to the entire depth of bricks. Period of soaking would vary depending on porosity of bricks and it could be determined by soaking a few bricks for different periods and then breaking them to find out depth of penetration of moisture. When bricks are soaked by immersion, these should be taken out from the tank a little while before their actual use, so that these are surface dry at the time of use.

2.3.2 All loose materials, dirt and set lumps of mortar which may be lying over the surface, on which brick masonry is to be freshly started should be removed with a wire brush and surface should be wetted slightly. Bricks should be laid with frog up, on full and even bed of mortar. While laying, bricks should be slightly pressed to ensure good adhesion. All cross joints and wall joints should be properly flushed and filled with mortar so that no hollow spaces are left. Evenness of bed joint and proper filling of wall joints ensures maximum strength and proper filling of cross joints ensures better resistance to penetration of moisture which takes place mainly through cross joints. In case of walls thicker than one and a half-brick, vertical joints should be grouted at every course in addition to flushing of vertical faces of bricks with mortar.

The course at the top of plinth, sills and parapets and just below floor/roof slab, should, where feasible be brick-on-edge (applicable only in case of traditional bricks), using cut bricks at corners to form what is known as 'panja' or 'marukona' (Fig. 8).

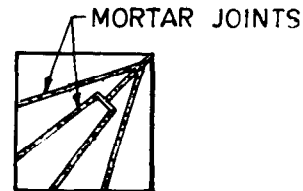

FIG. 8 TYPICAL ARRANGEMENT OF CUT BRICKS IN A CORNER

2.3.3 Thickness of courses should be kept uniform and for this purpose a wooden straight edge (known as storey rod) with graduations giving thickness of each course including joint thickness should be used. Height of window sills, soffits of lintels, beams and slabs and such other important levels/planes, in the height of the wall should also be marked on it. Thickness of mortar joints should not exceed 10 mm unless otherwise stipulated. It should be borne in mind that strength of masonry decreases with increase in thickness of joints and *vice versa*.

2.3.4 All brick masonry should be built in uniform layers racking back where necessary at corners, and for long lengths. Provision for subsequent construction of cross-walls should be made by leaving indents of $\frac{1}{4}$ brick in depth and width equal to thickness of wall, in alternate courses. Similarly, provision for future extension should be made by toothing at the end of a wall. No part of a wall during its construction should be raised more than 1 metre in one day in case of one brick or thicker walls and 0.6 metre in one day in case of a half-brick wall. This is to obviate possibility of squeezing out of green mortar from joints of masonry under self-load and also to avoid unequal settlement of foundation of a building.

2.3.5 Striking/Finishing of Joints

If a wall is to be plastered over, face joints should be raked to a depth of 10 mm while the mortar is green, in order to provide key for plaster. In case a wall is to be finished by pointing, face joints should be raked to a depth of 15 mm and face of masonry should be wire brushed to remove loose mortar and blemishes from the surface. If, as an economic measure, joints are to be finished flush without any plastering or pointing, this should be done while the mortar is green.

2.3.6 From structural and other considerations, horizontality of courses and verticality of walls and columns are very important. For ensuring horizontality of courses a straight edge and spirit level are used by the mason to check every course as the work proceeds. For checking verticality a straight edge and plumb-bob are employed. Deviation in verticality should not exceed 6 mm for a height of 3 m or one storey, and a total of 12.5 mm for the entire height when the building is more than one storeyed.

2.3.7 Improved Method of Brick Laying

An improved method of brick laying has been evolved by CBRI (Refer CBRI Building Digest No. 89) so as to increase productivity of masons. In this method of brick laying, special gadgets called 'end frame', 'string holder' and 'mortar board' are made use of. For success in the adoption of this method of laying bricks, masons should be given a brief training in the use of the special gadgets and practice in following a particular sequence of operations for laying bricks.

2.4 Fixing Door and Window Frames

2.4.1 Door and window frames can be fixed in masonry either at the time when masonry work is in progress or subsequently in openings left in masonry for the purpose. Former method has the advantage that there are no gaps between the frames and masonry and thus fixing of frames is firm and sound. Disadvantage in this method is that frames made of wood are liable to get damaged due to the work in progress and special care has therefore to be taken to protect them

from damage. The second method has the advantage that work is not held up if there is delay in the supply of frames, and there is no likelihood of wooden frames getting damaged due to dropping of brick bats, mortar and curing water, movements of workmen, etc. Disadvantage of the second method is that in order to facilitate subsequent fixing of frames, width of openings in case of doors and width as well as height of openings in case of windows has to be kept more than the width/height of frames to the extent of about 10 mm. The gap thus left between frame and the masonry/lintel has to be made good by increase in the thickness of plaster in jambs and soffits of openings.

2.4.2 Frames of doors and windows are fixed in position with the help of holdfasts of adequate size and strength embedded in brick masonry by leaving recesses in masonry of suitable length, two courses in height and of width equal to full thickness of wall and subsequently filling the recesses with cement concrete of 1 : 2 : 4 mix, using coarse aggregate of size 10 mm and below. When door and window frames are to be provided later in openings left in masonry, recesses should be left in masonry at levels corresponding to the position of holdfasts. These recesses should be temporarily filled in with unjointed brick-bats which are removed at the time of fixing of frames, recesses are filled with cement concrete at the time of fixing of frames, for embedding the holdfasts.

2.5 Honey-Combed Brick Masonry

2.5.1 For laying honey-combed brick masonry, pattern as shown in drawings should be followed. Bricks should have a minimum bearing of 4 cm on either side in case of half-brick wall and 2 cm in case of one-brick wall. Bricks should be laid with frog down.

2.6 Brick Masonry Curved on Plan

2.6.1 When radius of curvature of brick masonry curved in plan exceeds 6 metres, it can be laid just like ordinary brickwork, by providing some taper in cross joints. When radius of curvature is 6 metres or less, either specially moulded bricks should be used or bricks cut to required radius should be laid in header bond. Use of specially moulded bricks is however feasible only in large works. In case of unimportant works such as lining of soakage pits and cesspools of circular shape, curved brickwork may be provided by using uncut bricks, and thick tapered cross joints, thus obviating labour on cutting of bricks.

2.7 Extension of Old Brick Masonry

2.7.1 Normally provisions for future extension of brick masonry should be made at the time of initial construction as mentioned in 2.3.4. When no such provision has been made, proper bonding of new work with old should be carefully made.

2.7.2 For making addition of a new cross-wall, recesses in old brickwork should be cut out, at

regular intervals, equal in width to the width of new wall three courses in height and half-brick in depth, spacing of the recesses also being three courses. New brickwork should then be built into the recesses formed in old brickwork using some strong mortar. For making longitudinal extension of a wall, the new wall should be toothed for its full width with the old wall up to a depth of one quarter brick length in alternate courses. New brickwork should be laid in such a way that height of each course is the same as that of corresponding old course. It should be ensured that there is no hump or projection at the junction of old and new brickwork.

2.7.3 In case bricks used in old brick masonry are of size as per foot-pound system, while in new brick masonry, bricks of size as per metric system are to be used, height of recesses in old brickwork as well as their spacings should be 4 courses of old brick masonry and height of 3 courses of new brick masonry should correspond to that of 4 courses in old brick masonry, making suitable adjustment, if necessary by varying thickness of joints of new brickwork.

2.7.4 Old brickwork should be thoroughly cleaned of old mortar and wetted before jointing it with new brickwork.

2.8 Corbelling

2.8.1 Where corbelling is required in brick masonry for supporting some other structural member, maximum projection of individual bricks should not exceed one-half the height of brick nor one-half of its built-in part and overall horizontal projection of the corbel should not exceed one third of the thickness of wall. It is preferable to adopt header courses in the corbelled portion of brick masonry from consideration of structural stability and economy.

2.8.2 Structural stability of the corbel should be ensured as per provision of clause 6.4.2 of IS 1905 : 1987. Corbelled masonry should not be loaded till it has fully set and sufficient masonry above corbel has been laid so that counterbalancing weight is not less than twice the over turning weight.

2.9 Efflorescence

2.9.1 Phenomenon of appearance of white deposits on the external as well as internal surface of walls (mostly external) is called efflorescence. It is due to the movement of soluble salts—mainly sulphates of sodium, magnesium, potassium and calcium in solution to the surface, evaporation of moisture and crystallization of salts at the surface. Efflorescence may appear on exposed brickwork or plastered surface or may appear through painted surface.

2.9.2 Efflorescence can occur only if there is some source of soluble salts as well as moisture. Soluble salts may be present in bricks used for masonry or in sand used in masonry and plaster work or in

ground water in contact with foundation. Where source of salts is brick or sand, efflorescence appears soon after construction in the first dry spell when water used in construction dries up. This efflorescence could be easily removed by wire brushing the surface. If masonry does not get wet again, as in case of internal and protected walls, there may be no further recurrence of efflorescence. In case of external walls, however efflorescence may appear again during subsequent cycles of wetting and drying, but to a gradually lessening extent and may stop altogether in course of time as the salts get depleted.

Efflorescence appearing on exposed brickwork may cause no damage to masonry if bricks are strong and well burnt. Weak and under-fired bricks however are liable to get crumbled at the surface due to strong force exerted by the process of crystallization of salts. If the brickwork had been plastered over, before drying out of construction water used in masonry, plaster is likely to get damaged and flaked due to the salts. Surface finish on plaster is also likely to get spoiled if it had been applied before drying out of masonry and plaster.

2.9.3 Where source of soluble salts is ground water, efflorescence will affect super-structure only if there is no DPC at plinth level or DPC used is not very effective; otherwise efflorescence will appear only on external masonry below DPC level. Since ground water would provide an inexhaustible source of salts, efflorescence due to this source will appear whenever there is a dry spell and it would thus, in course of time, weaken the masonry and affect the life of the structure. This brings out the necessity and importance of using well burnt bricks in good mortar in foundation and plinth and providing a good DPC at plinth level, particularly when the water table in the area is high and soil contains appreciable quantity of soluble sulphates.

2.9.4 Incidence of efflorescence in buildings could be reduced if following measures are adopted at the stage of construction of a building and subsequent maintenance.

2.9.4.1 Bricks should be tested for their efflorescence rating and use of bricks liable to excessive efflorescence should be avoided if possible.

A simple test for determining 'efflorescence' rating of bricks consists in standing a brick vertically in a flat bottom dish containing distilled water up to a depth of 2.5 cm, till the entire water is absorbed and the brick appears to be dry. Water is again added to the dish to the same level i.e. 2.5 cm depth and allowed to get absorbed and evaporated. The brick is examined after second evaporation. If there is deposit of salts covering 50 percent or more of the brick surface, the brick is rated as liable to excessive efflorescence. This test should be carried out on at least 5 bricks

selected at random from a lot for coming to a conclusion.

2.9.4.2 Sand used in mortar for masonry and plaster should not contain more than 0.1 percent of soluble salts (chlorides and sulphates).

2.9.4.3 When water table is within 1.5 m of subgrade and soil contains appreciable percentage of soluble sulphates, mortar used for masonry in foundation and plinth should be as in **1.4.6.1(d)** and at plinth level a good DPC should be provided.

2.9.4.4 Before application of decorative coats of distemper or paint to the plaster, it should be ensured that plaster has fully dried.

2.9.4.5 At plinth level, an effective course of DPC such as a 4 to 5 cm thick layer of cement concrete 1 : 1½ : 3 containing some integral water proofing compound, should be provided.

2.9.4.6 Since efflorescence can take place only when there is some source of moisture, dampness in any part of a building due to rain water, water leaking from storage tanks or leakages in plumbing system should be guarded against by ensuring soundness of construction and good maintenance.

2.9.4.7 Apart from efflorescence, sulphate salts when present in bricks, sand and ground water are likely to cause cracks in masonry and plaster and weaken a structure due to what is termed as 'sulphate attack'. Soluble sulphates in the presence of moisture undergo a chemical action with portland cement used in mortar, thus forming a compound which exerts expansive force on masonry and plaster and causes damage. This phenomenon has been dealt with in detail in "SP : 25 Causes and Prevention of Cracks in Buildings".

SECTION 3

3 STONE MASONRY

3.1 General

3.1.1 Use of stone in masonry for buildings in this country has been made for a long time as can be seen from some old monuments and historical buildings. Stone suitable for building construction is available in many parts of the country. Main reason for popularity of stone masonry in the past was its durability, strength and ease of construction.

3.1.2 Types of stone commonly used in building construction are granite, trap, basalt, quartzite, limestone, and sandstone. Another type of stone which is a semi-weathered rock—namely laterite, though not very durable and strong, is available in some regions of this country, and is used for small and low cost structures.

3.1.3 As a general rule, stone for use in masonry should be hard, sound and free from weathering, decay, cavities, cracks, sand-holes, injurious veins, patches of loose or soft materials, etc. Its water

absorption should not exceed 5 percent. Stone should not contain cryptic crystalline silica or chert, mica, or other deleterious materials like iron oxide and organic impurities. Selection of stone is usually based on past experience, and in order to ensure desired quality, it is customary to stipulate source of stone that is particulars of quarries from which stone should be procured for use in a particular job.

3.1.4 All stones should be wetted before use. Masonry should be laid truly in plumb or to required batter where so specified. Height of construction in a day should not exceed 1 metre so as to avoid excessive load on fresh mortar. Connected masonry should be raised uniformly all over. However, if one part of masonry is to be left behind, the wall should be racked at an angle not steeper than 45 degrees. Toothing in stone masonry should not be allowed.

3.1.5 There are three main varieties of stone masonry in common use namely random rubble, coursed rubble and ashlar, with some further sub-varieties depending upon quality of stone, standard of dressing and laying of stones, standard of finish and workmanship and architectural style. For the sake of brevity only the main varieties of stone masonry are described in this Handbook.

3.2 Random Rubble Masonry

3.2.1 General

In this variety of masonry (see Fig. 9) as the name suggests, stones are laid at random, that is without any regular courses and for that reason, it is sometimes also designated as "Uncoursed rubble masonry". For this masonry, labour spent on dressing of stone is minimal and thus it is least expensive. This masonry has a rough finish and also is not very strong. It is, therefore, adopted for low-cost and low-height structures where economy in cost is a primary consideration, much strength is not needed and appearance does not matter.

3.2.2 Size of Stone

Selection and grading of stones for rubble masonry is mainly done at site using selected and larger stones at the faces and smaller stones in the hearting. Ordinarily stones for use in this masonry should be small enough so that these could be lifted by hand. Minimum size of stone however should be such that it does not pass through a ring of 15 cm internal diameter and a rectangular slit of 10 cm width. Height of stones may be up to 30 cm. Length of a face stone at its base should not be less than its height nor greater than three times the height. Breadth of a stone at base should not be greater than three-fourth of the thickness of wall nor less than its height, and at least one-fourth of the face stones which are not less than 200 cm² in section, should tail into the work to the extent of 2/3rd the thickness of wall for walls thicker than 30 cm and for full thickness

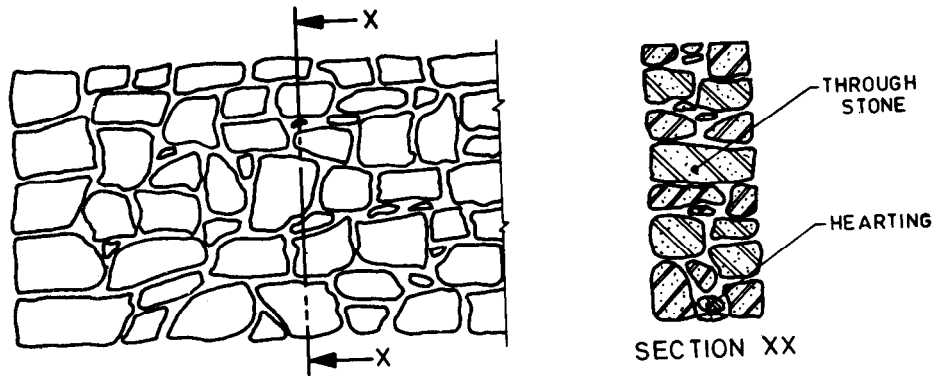

FIG. 9 RANDOM RUBBLE UNCOURSED MASONRY

of wall for walls 30 cm or less in thickness. Size and number of bond stones should be as given in 3.2.4.4.

3.2.3 Dressing of Stone

Stone should be hammer dressed on the face, sides and bed to enable them to come in proximity with the neighbouring stones. Bushing on the face should not be more than 4 cm from the general wall surface. However, for the face to be plastered, bushing should not exceed 1 cm.

3.2.4 Laying of Stones

3.2.4.1 Stones should be wetted before use, laid on their natural quarry bed and solidly bedded in mortar by hammering them down to position with a wooden mallet. No pinning should be done in the face. Stone chips, not exceeding 20 percent of volume of masonry may be used in hearting where necessary to avoid thick mortar joints, taking care that no hollow spaces are left in masonry. Chips should be used only for filling interstices between adjacent stones and no chips should be used below bed of hearting stones to bring the latter in level with face stones. Hearting should be laid nearly level with the face stones except for the vertical bond stones or 'plumbs'. Projecting upwards to the extent of 15 to 20 cm at about one metre intervals.

3.2.4.2 Though stones are laid without adhering to any courses, masonry is required to be brought to level at plinth, window sill, lintel and roof levels. This should be done firstly by selecting stones of appropriate height and secondly, if necessary, by providing a levelling course of concrete made by mixing 1 part of mortar used for masonry and 2 parts of stone aggregate of 20 mm nominal gauge.

3.2.4.3 Bonding in masonry is obtained by closely fitting adjacent stones, by using specified proportion of headers and bond stones, and by laying face stones so as to break vertical joints as much as possible, avoiding long vertical joints.

3.2.4.4 Bond stones

There should be at least one bond stone (also called 'through stone') for every 0.5 m² of wall surface. These stones should be marked with white paint at the face for subsequent check and verification during construction. In case of a wall up to 60 cm thick, length of bond stones should be equal to thickness of wall, while for walls thicker than 60 cm, two or more stones with an overlap of at least 15 cm should be used to serve as a bond stone. Bond stones should have a minimum section of 400 cm². Where bond stones of suitable length are not available these could be made of precast cement concrete 1 : 3 : 6 (1 cement : 3 sand : 6 stone aggregate of 20 mm nominal gauge). In case of highly absorbent stones (porous limestone and sandstone) the bond stone should extend to about two-third into the wall for all walls whatever the thickness and a set of two or more bond stone with an overlap of 15 cm should be provided. Use of a single bond stone for full thickness in this case is likely to result in movement of moisture to the inside face of the wall, through the bond stone, if continuous from face to face.

3.2.4.5 Quoin stones

Quoins that is corner stones should be selected stones dressed with hammer and/or chisel to form the required angle. Length of these stones should be 45 cm or more and at least 25 percent of the stone should be 50 cm or more in length. These should be laid as headers and stretchers alternately. The quoins should have a uniform chisel draft of at least 2.5 cm width at four edges of each exposed face, all the edges of a face being in one plane. No quoin should be smaller than 0.025 m³ in volume.

3.2.4.6 Jambs

Stones used in jambs should be similar to those in quoin, excepting the length of the stem which should be 45 cm or thickness of wall whichever is less.

3.2.4.7 Joints

All joints should be completely filled with mortar and face joints should not be thicker than 20 mm. When surface of masonry is not to be pointed or plastered, joints should be struck flush and finished at the time of laying. In case plastering or pointing is required, joints should be raked to a depth 20 mm while the mortar is still green. It is desirable to do pointing, where required, within a few days of paying masonry to ensure good bond.

3.3 Coursed Rubble Masonry

3.3.1 General

In this variety of masonry (see Fig. 10) stones are laid in courses, height of each course being not less than 15 cm nor more than 30 cm. All face stones in one course should be of same height. This type of masonry has two sub-types known as 'first sort' and 'second sort'. In masonry of first sort, height of all courses should be same while in masonry of second sort, height of courses may vary but height of any course should not be greater than that of a course below it and difference in height of 2 adjacent courses should not exceed 2.5 cm. In the latter variety of masonry, at places 2 stones could be used in the face to make up height of a course.

3.3.2 Size of Stone

This should be same as for random rubble masonry except that for this masonry at least one third of the stones (by volume) should tail into the work for a depth not less than twice their height.

3.3.3 Dressing

Face stones should be hammer dressed on all beds and joints so as to give them approximately rectangular shape. These should be square on all beds and joints. The bed joints should be chisel drafted for at least 8 cm from the face and side joints for at least 4 cm. No portion of a dressed joint should show a depth of gap of more than 6 mm in case of masonry of first sort and 10 mm in case of masonry of second sort from a straight edge placed on it and no portion of the stone should project beyond the surface of bed and side joints. Standard of bushing on the exposed face should be same as for random rubble masonry.

3.3.4 Laying

All courses should be laid truly horizontal, and vertical joints should be truly vertical. All stones should be bedded solidly into the mortar. Stones should be laid as headers and stretchers alternatively. Volume of chips used for filling interstices in the hearting should not exceed 10 percent in case of this masonry of first sort and 15 percent in case of masonry of second sort. While using chips it should be ensured that no hollow spaces are left anywhere in masonry. No pinning should be done at face.



JOINTS 17 mm
THICK

ELEVATION



PLAN FOR COURSE 1



PLAN FOR COURSE 2



CROSS SECTION

FIG. 10 COURSED RUBBLE MASONRY

3.3.5 Bond Stones

These should be same as for random rubble masonry (clause 3.2.4.4) except that these should be provided in every course, at not more than 1.8 m intervals.

3.3.6 Quoin Stones

No quoin should be smaller than $.025 \text{ m}^3$ in volume. Quoin stones should be of same height as that of the course in which they occur. These should not be smaller than 40 cm in length, should be rough chisel dressed to a depth of 10 cm at the beds and should have a uniform chisel draft of 2.5 cm at all four edges of each exposed face. These should be laid square on beds as headers and stretchers alternatively.

3.3.7 Jambs

Stones used in jambs of doors, windows and other openings should be similar to those in quoins except that minimum length should be 40 cm or thickness of wall whichever is less.

3.3.8 Joints

All bed joints should be horizontal and side joints vertical. These should be made and treated as in case of random rubble masonry except that thickness of joints should not exceed 10 mm in case of masonry of first sort and 15 to 20 mm in case of masonry of second sort.

3.4 Ashlar Masonry

3.4.1 General

Ashlar masonry is the superior most of all varieties of stone masonry and is provided generally in important and prestigious buildings where strength, architectural appearance and durability of the structure are some of the major considerations. Stones of appropriate quality are carefully selected and dressed to suitable size and shape. This variety has some sub-varieties, depending on standard of dressing and workmanship; the main sub-varieties being called 'plain ashlar—fine tooled' and 'plain ashlar—rough tooled'. Plain ashlar—fine tooled masonry is illustrated in Fig. 11.

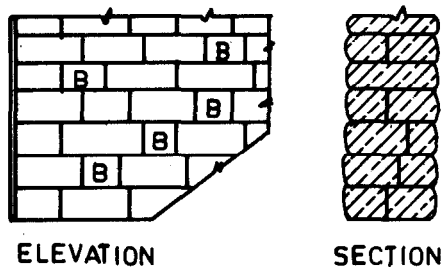

FIG. 11 PLAIN ASHLAR FINE TOOLED MASONRY

3.4.2 Plain Ashlar—Fine Tooled Masonry

3.4.2.1 Size of stone

Height of stones after dressing should not be less than 15 cm nor greater than 30 cm inclusive of thickness of joints, and for high class work, all courses should be of uniform height. In less important works variation in height of courses may be permitted such that height of any course is not greater than the height of all courses below that course. Length of a stone should not be less than twice nor greater than thrice the height and breadth should not be less than height.

3.4.2.2 Dressing of stones

The stones should be cut to regular and required size and shape so that all sides are rectangular and joints could be truly horizontal and vertical. All sides of stones should be chisel dressed such that a fairly smooth surface is obtained and no point on the dressed surface is deeper than 1, 3, 6 and 10 mm from a 60 cm long straight edge placed on the surface of exposed face, beds, sides, and rear surface respectively. All angles and edges that remain exposed in the final position should be true square and free from chippings.

3.4.2.3 Laying

Stones should be laid on full and uniform bed of mortar and bedded in position with wooden mallet without use of chips or pinning of any sort. Stones should be laid as headers and stretchers alternately. Headers should be placed, as far as possible, over middle of the stretchers below and stones should break joints on the face for at least half the height of the course and the bond should be carefully maintained throughout. For walls up to 80 cm thick, all headers should have length equal to full thickness of wall. If necessary, jib cranes and other mechanical appliances should be used to handle heavy pieces of stones and to place them into correct position. When racking is unavoidable, its slope to the horizontal should not exceed 30°.

3.4.2.4 Joints

All joints should be uniform and not more than 5 mm in thickness. A uniform recess of 15 mm depth from the face should be left in all joints with the help of a steel plate during construction. All exposed joints should be pointed with mortar as per architectural requirements. Normally joints are finished with pointing which is sunk to a depth of 5 mm from the face, depth of mortar in pointing being not less than 10 mm. Colour of mortar for pointing should match with the colour of stone and for this purpose fine aggregate should be obtained by crushing chips of stone used in masonry.

3.4.3 Plain Ashlar

Rough Tooled Masonry—This type of masonry is similar to plain ashlar fine tooled masonry described above, except that exposed face should have a fine chisel draft, 2.5 cm wide round the edges and should be rough tooled between the draft such that the dressed surface should not deviate more than 3 mm from the straight edge placed over it.

3.4.4 Ashlar Stone Masonry with a Backing of Coursed Rubble Masonry

In many cases inner faces of ashlar masonry walls are finished in plaster. In such cases backing of ashlar masonry consists of coursed rubble stone masonry and two varieties of masonry are laid together in uniform courses of same height with proper bonding of the two types. Back faces of stones used in ashlar masonry need not be dressed to the standard required for ashlar masonry and may simply tail into coursed rubble masonry.

3.4.5 Ashlar Stone Masonry with a Backing of Brickwork

In regions where normal mode of walling is brickwork, ashlar faced walls generally have backing of brickwork. It is essential that the facing is effectively bonded with backing. This is achieved and wastage of bricks and labour in cutting of bricks avoided by: (a) making the

ashlar courses alternately half-brick and one brick in breadth; (b) providing breadth of brick backing as a multiple of half-brick; and (c) keeping height of each course of ashlar same as the height of a few brick courses inclusive of thickness of bed joints. It is desirable that high strength bricks of first grade with very thin joints are used in backing so as to ensure reasonable compatibility between stone masonry and brickwork.

3.4.6 Mortar

Mortar for ashlar masonry should be reasonably strong and durable. Mortar mix should therefore be either cement—sand mortar 1 : 5, 1 : 4 or 1 : 3 or composite cement—lime—sand mortar 1 : 1 : 6/1 : ½ : 4½, depending on strength requirement, loads and other considerations.

3.5 Laterite Stone Masonry

3.5.1 General

Laterite stone should be compact in texture. It may be mottled with streaks of brown, red and yellow colours. It should not contain white clay or lithomarge or an appreciable number of deep sinuosities. Blocks should be obtained from a good ferruginous variety of laterite which hardens on exposure after it is quarried. Density of laterite stone should not be less than 2.5 gm/cm³ and moisture absorption should not exceed 12 percent.

3.5.2 Size of Stone Blocks

Minimum height of blocks should be 19 cm actual that is 20 cm nominal with normal joint thickness of 10 mm. Breadth of blocks should be equal to height and length should be equal to twice the height. Standard sizes of laterite blocks as per IS 3620 : 1966 are given in Table 1.

3.5.3 Dressing of Stones

Stones should be dressed soon after quarrying into regular rectangular blocks so that all faces are free from waviness and edges are straight and square. Blocks may be cut to size either manually or by machine, but for good quality work it is desirable to use machine cut blocks. Stone blocks after dressing should be exposed to atmosphere for a period of 3 months before use in masonry. This stone, on exposure changes its nature and improves in compressive strength.

3.5.4 Laying

Blocks are laid in masonry in regular horizontal courses, breaking bond of vertical joints in every course to the extent of at least half the height of blocks. When a masonry element is thicker than breadth of blocks, these should be laid as headers and stretchers similar to English bond of brickwork. All joints should be completely filled with mortar. Normally all courses should be of same height.

3.5.5 Joints

Thickness of joints in good quality work should not exceed 10 mm. Faces may be plastered, pointed or finished flush depending on architectural effect to be achieved. When surface is to be plastered or pointed, joints should be raked while the mortar is green to a depth of 10 mm and 15 mm respectively. Pointing should be done as early as possible after raking of joints to ensure good bond.

3.6 Stone Veneering

3.6.1 Wall faces are sometimes, veneered with thin slabs of stone or marble with the object of providing a decorative and durable finish. Mostly veneering is provided on the external face for architectural effect, but it is also provided on the internal face in special areas such as entrance halls and toilets.

3.6.2 For veneering stones generally used are sandstone, limestone and marble, the walling being generally brickwork, rubble stone masonry or R.C.C. Veneering stone should be hard, sound, and free from cracks flaws, decay and weathering and it should be of uniform or specified texture. Colour and texture of stone or marble are specified on considerations of architecture, durability, cost and availability. Detailed specifications of limestone and marble slabs are given in IS 1128 : 1974 and IS 1130 : 1969 respectively.

3.6.3 Thickness of stone veneer generally varies between 2 to 8 cm, depending on type of stone, architectural style, and type of building. As a general rule, when using expensive variety of stone for facing, comparatively a thin veneer stone is specified, for economy in cost.

3.6.4 Dressing

3.6.4.1 Sandstone and limestone

Sandstone and limestone slabs should be cut to the required size and shape so as to be free from any waviness and to give truly vertical and horizontal joints with the adjoining slabs. The faces that are to remain exposed in the final position as well as the adjoining faces to a depth of 6 mm should be fine chisel dressed so that when checked with a 60 cm straight edge, no point in the finished surface varies from it by more than 1 mm. The faces top bottom and vertical sides which are to form joints should be chisel dressed so that variation from straight edge at no point exceeds 5 mm. Dressing at the back should not be done so as to ensure good grip with the backing. All angles and edges that are to remain exposed in the final position should be true square free from chippings.

3.6.4.2 Marble slabs

Marble slabs should be cut to required size and shape and chisel dressed on all beds and joints so as to be free from any waviness and to give truly

vertical and horizontal, radial or circular joints as required. The exposed faces and joints 12 mm from the face should be fine tooled such that straight edge laid along the face of the slab is in contact with every point on it. The surfaces should then be rubbed smooth. All visible edges and angles should be true square and free from any chippings. Beyond the depth of 12 mm from the face, the joints should be dressed with a slight splay so that joints are V shaped, being thin at the face and wide at the back. Surface of the stone coming in contact with backing should not be dressed so as to ensure a good grip with the backing.

3.6.5 Laying and Fixing

3.6.5.1 Stone slabs should be thoroughly wetted before laying. All joints should be truly horizontal and vertical and face should be in plumb. For grounding in case of stone and marble and jointing in case of stone slabs, mortar generally used is cement mortar 1 : 4 or cement-lime mortar 1 : ½ : 4. In case of marble, mortar for jointing should be same as specified for pointing, and care should be taken that mortar used in the grounding does not spill over to the joints or exposed face. It should be ensured that no hollows are left in the grounding and that all joints are completely filled.

3.6.5.2 Slabs should be anchored to the backing by means of cramps (of bronze, gunmetal or some other non-corrodible metal). In case of thin veneers (less than 16 cm in thickness) and by means of stone dowels in case of thick veneers (6 cm or more in thickness). In addition slabs should be interconnected to each other in the horizontal direction by means of copper pins in case of thin veneers and by means of cramps in case of thick veneers. Cramps generally used are of size 3 mm × 2.5 cm × 20-30 cm and normal size of pins is 6 mm dia × 7.5 cm long. Spacing of cramps, stone dowels and pins would depend on size of slabs but it is necessary to ensure that each slab is properly secured to the backing as well adjoining slabs. Cramps dowels and pins are generally fixed in cement mortar 1 : 2, using fine sand. Some typical details for fixing veneering slabs are shown in Fig. 12, 13, 14 and 15.

3.6.5.3 The facing should be provided with a continuous support at the ground level as well as at every storey level that is, at about 3.5 m vertical intervals, the supports being in the form of projections in concrete floor slab or beams between columns or angle iron attached to backing. Such supports should also be provided the top of all openings and soffits of cantilevered portions. Alternatively specially designed cramps in accordance with IS 4101 (Part 1) : 1967 may be used so as to hold the facing in position as well as to transfer full weight of facing to the backing. In case of large buildings, provision in fixing arrangements for veneering work should be made for movements in facing due to creep, elastic

deformation and thermal variations.

3.6.5.4 Pointing

All exposed joints in facing should be pointed with mortar, as may be specified for the purpose to match the colour of the facing. Pointing in case of stones other than the marble, should be sunk from the face by 5 mm and depth of pointing should not be less than 15 mm. In case of marble veneering, mortar joints should be finished neat and fair in jointing mortar as the work proceeds, since joints being very thin, no subsequent pointing is possible.

3.6.5.5 Jointing

Thickness of joints should not exceed 5 mm in case of sandstone and limestone veneering and 1.5 mm in case of marble veneering. In the former case, a uniform recess of 20 mm depth from face should be left with the help of a steel plate. In the latter case jointing should be done with mortar specified for pointing.

3.6.5.6 Finishing

After the marble veneering has been cured, it should be rubbed with carborundum stone of grades 60, 80 and 100 in succession, so as to give a plane, true and smooth surface. It should then be cleaned with oxalic acid solution, washed and finished clean.

3.7 Miscellaneous Items

3.7.1 Stone Pillars

Masonry in stone pillars is as a general rule similar to that of masonry used for walls in a job in regard to quality and size of stones, dressing of stones, height of courses, quoin stones, bond stones, jointing, finish, etc, with the following exceptions:

- a) *Random rubble masonry*— Bushing of exposed faces should not exceed 20 mm. Quoins should have length not less than 25 cm for pillars up to 40 cm side, and 30 cm for pillars having side greater than 40 cm. Bond stones should not be less than 15 cm in height and should be hammer dressed on beds, faces and sides into squared blocks.
- b) *Coursed rubble masonry*— Beds of stones should be rough tooled true and square for a distance of at least 10 cm from the face and the sides of stones for at least 5 cm from the face. Beds and sides of quoins should be rough tooled for a distance of at least 10 cm from the face. Length of the stone should not be less than 1½ times the height.
- c) *Ashlar masonry*— Minimum height of stones for fine tooled masonry should be 30 cm and for rough tooled masonry 20 cm.
- d) For pillars having a cross sectional area of 0.25 m² or less, bond stone should be a single full stone and for pillars exceeding

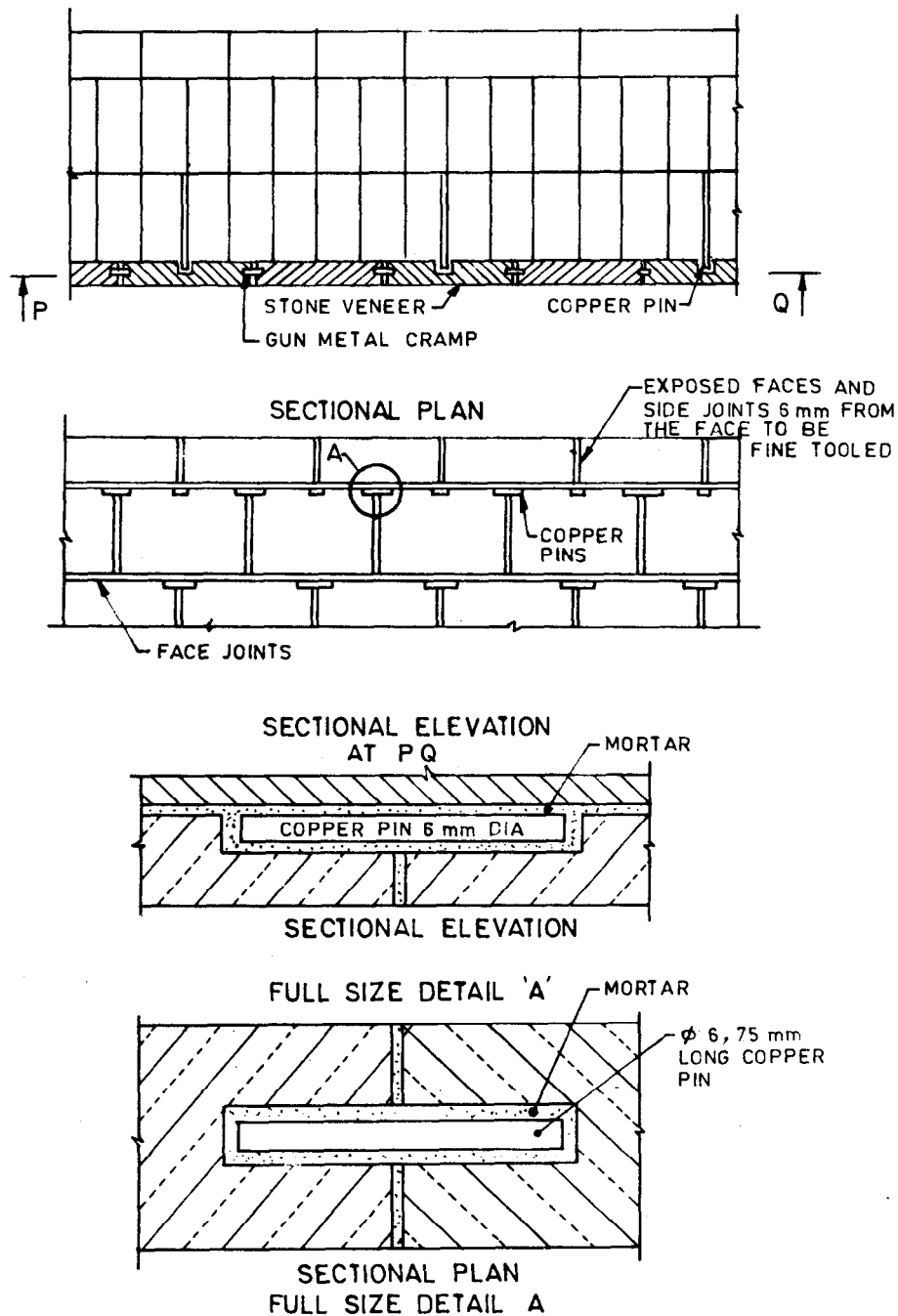
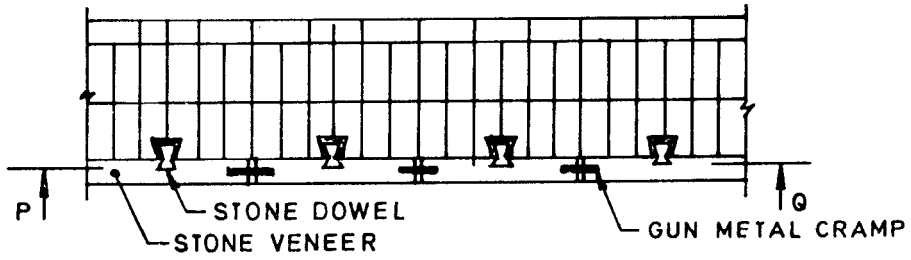
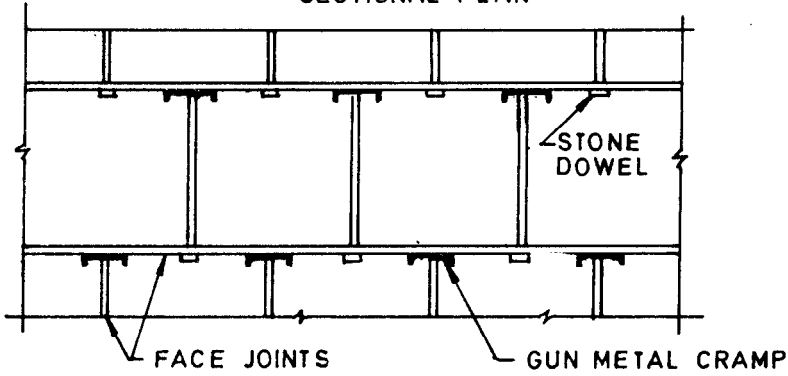

FIG. 12 TYPICAL DETAILS OF FIXING STONE VENEER WORK FACING USING GUN METAL CRAMPS AND COPPER PINS



SECTIONAL PLAN



SECTIONAL ELEVATION AT P Q

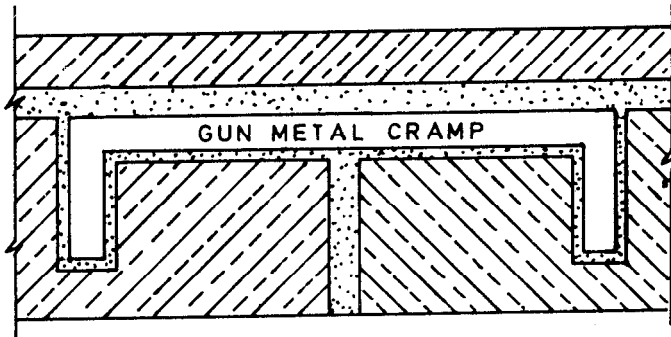

SECTIONAL ELEVATION
(FULL SIZE DETAILS AT 'A')

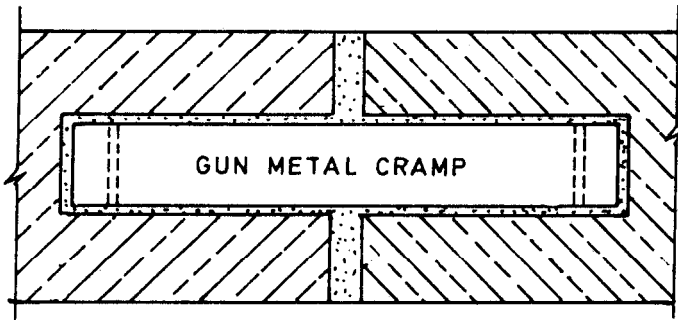

SECTIONAL PLAN
(FULL SIZE DETAILS AT 'A').

FIG. 13 TYPICAL DETAILS OF FIXING STONE VENEER WORK USING STONE DOWELS AND GUN METAL CRAMPS

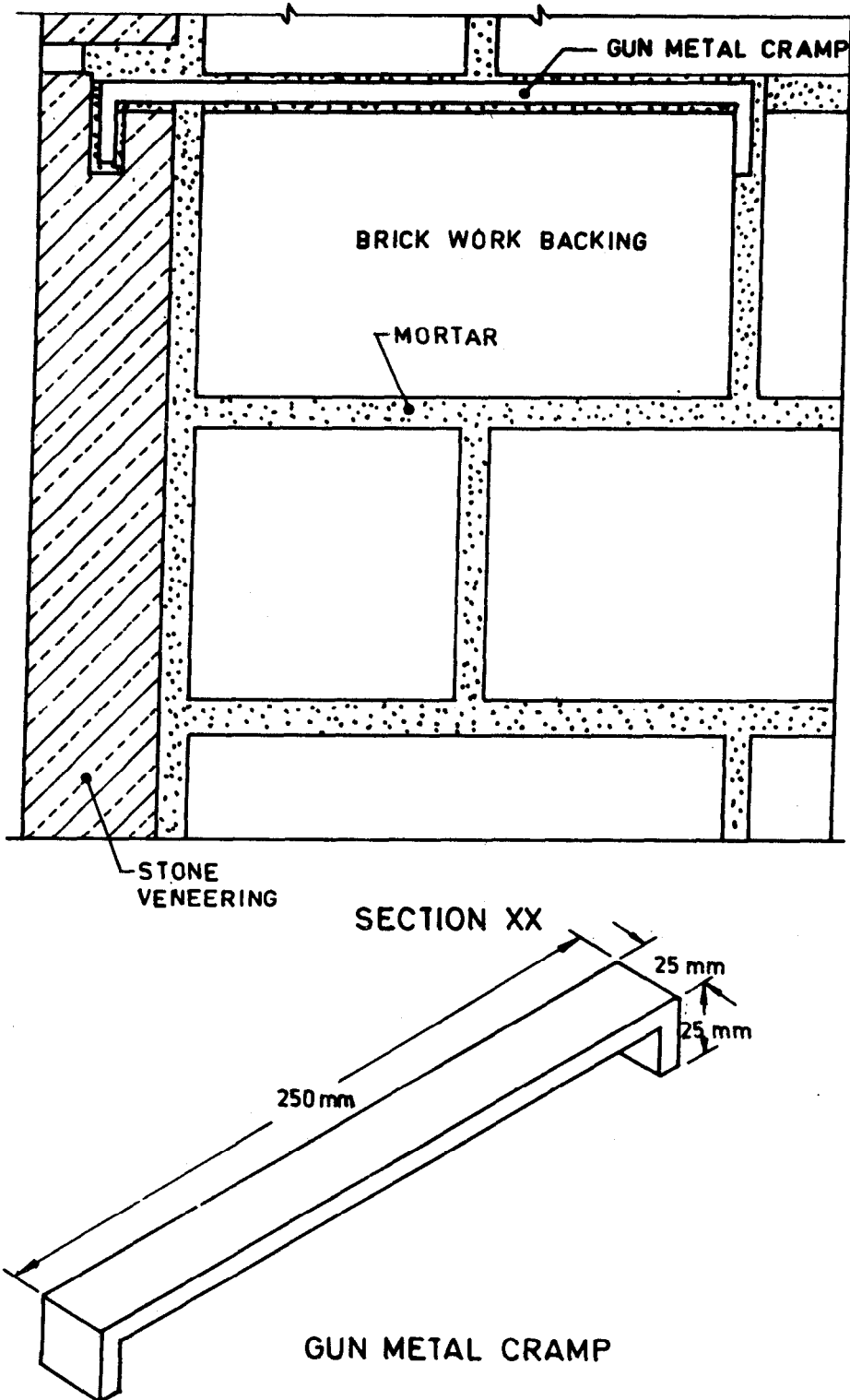

FIG. 14 TYPICAL DETAILS OF FIXING STONE FACING SHOWING USE OF GUN METAL CRAMPS

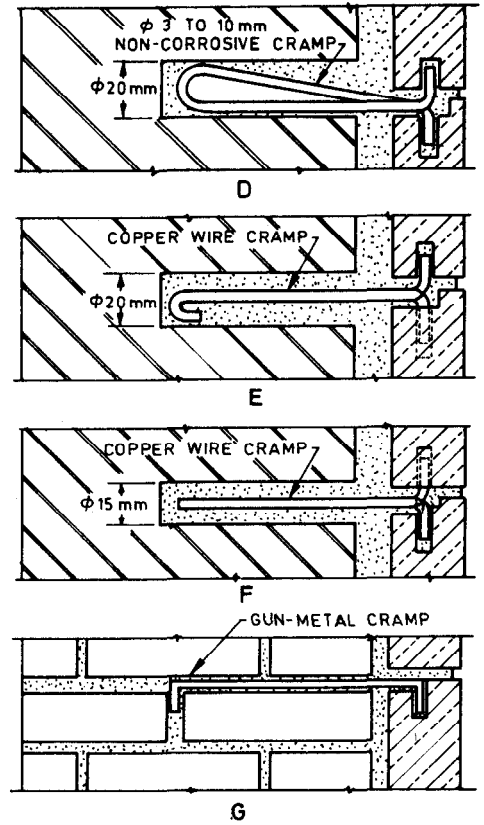
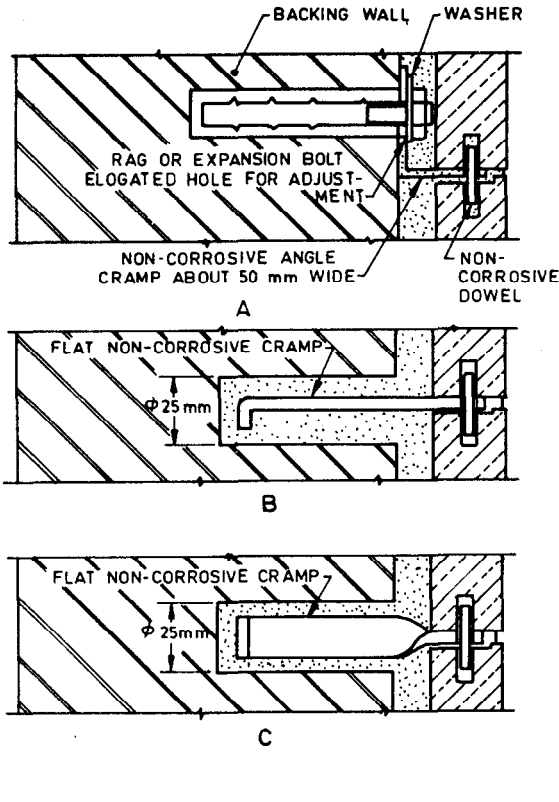

FIG. 15 TYPES OF CRAMPS FOR STONE FACINGS

0.25 m² in area, it should be made up of four stones provided in two courses at right angle. Three bond stones should be provided in each pillar of storey height at bottom, middle and top. In case of plastered masonry, bond stones could be of precast cement concrete of M-15 grade laid on the full section of pillar in one piece.

twice its breadth. Standard of dressing of stone should be as for ashlar masonry. Joints of the sill should break joints with those of masonry below. Thickness of vertical joints of sill should not exceed 1.5 mm in case it is fine tooled and 3 mm in case it is rough tooled. Embedment of sills into masonry on any side should not be less than 5 cm.

- e) Height of masonry laid in pillars in one day should not exceed 60 cm.

3.7.2 Corbels

3.7.2.1 Corbelling in brick masonry has been dealt with earlier in 2.8. Corbelling in stone masonry is generally similar to that in brick masonry. In view, however, of greater strength of units in case of stone masonry and difference in jointing, there are some minor variations.

3.7.2.2 For stone corbelling, breadth of embedded portion of stone should not be smaller than 1.5 times the breadth of projected portion. Vertical joints of corbel and its junction with adjoining masonry should break joints with those in the courses below and above.

3.7.3 Window Sills

Thickness of sills should not be less than 5 cm. Entire width of sill should be in one stone and length of any sill stone should not be less than

SECTION 4

4 CONCRETE BLOCK MASONRY

4.1 General

4.1.1 Concrete blocks for use in masonry may be solid hollow, lightweight or autoclaved cellular as per standard specifications IS 2185 (Part 1) : 1979, IS 2185 (Part 2) : 1983, IS 2185 (Part 3) : 1984 and IS 3115 : 1978. These are used for load bearing walls as well as non-load bearing panels and partitions. Choice of units should be made carefully, taking into consideration type of structure, loads, climatic conditions, economy in cost, ready availability of units, etc.

4.1.2 Concrete block masonry is very much prone to shrinkage cracks and, therefore, masonry units must strictly conform to standard specifications and suggestions for handling, storage, moistening before use, selection of mortar for laying masonry, curing and finishing as given below should be carefully followed so as to avoid or to minimise cracks. Moreover, it should be ensured that concrete blocks are dried for a period of at

least 28 days after curing so that the blocks undergo initial shrinkage before use in masonry work.

4.2 Handling and Storage of Blocks -

4.2.1 The blocks should be handled with care in transport as these are liable to get broken and damaged due to jolts and mishandling. These are to be stored at site in such a way that these may not be able to absorb moisture from any source. These shall, therefore, be stacked on planks, or such other supports and in inclement weather protected from rain.

4.3 Laying of Blocks

4.3.1 *Wetting Before Use*

In humid weather, blocks should not be wetted before laying. If weather is dry (humidity below 50 percent), bottom, top and sides of blocks may be slightly moistened. Excessive wetting of blocks before use in masonry is likely to result in extensive shrinkage cracks.

4.3.2 *Mortar*

As a general rule, mortar for concrete block masonry should be relatively weak and slow setting, so as to minimise possibility of shrinkage cracks. Generally speaking, composite cement—lime mortar is best suited for the purpose, using 1 : 2 : 9 mortar for normal work and 1 : 1 : 6 mortar when intensity of loading is high or masonry is exposed to weather. Mortar for masonry in foundation and plinth should be somewhat richer than that for super-structure masonry.

4.3.3 *Masonry in Foundation and Plinth*

For two or more storeyed buildings, it is desirable to avoid use of hollow blocks in foundations and plinth. If for some reasons hollow blocks are to be used for this purpose, hollows of the blocks should be filled with cement concrete 1 cement : 3 sand : 6 coarse aggregate of 20 mm nominal size. In single storeyed buildings, when using hollow blocks, the hollows should be filled with sand up to one course below plinth and the top course below plinth should be filled with cement concrete 1 : 3 : 6.

4.3.4 *Masonry in Super-structure*

4.3.4.1 First course of concrete block masonry should be laid with special care, making sure that it is properly aligned, levelled and plumbed, as this would greatly facilitate laying subsequent courses correctly. Before laying the first course, alignment of the wall should be marked on the DPC. On this, blocks should be first laid dry, that is without using mortar, aligning them correctly with the help of mason's line, in order to determine correct position of blocks including those of the cross-walls and to adjust their spacing. When blocks have been placed correctly, two corner blocks (one at each corner) are removed without disturbing adjoining blocks,

mortar is spread on the bed, and these blocks are placed back truly level and plumb. The string is then stretched tightly along the outer edge of these two corner blocks. Thereafter, each block is removed one by one and relaid over bed of mortar with mortar on sides, to correct level, alignment and plumb.

4.3.4.2 Having completed first course of blocks, other courses are laid on it, breaking joint and checking alignment, horizontality, verticality and trueness of plane with the help of mason's line, straight edge, mason's level and plumb bob. Use of a storey-rod should also be made to ensure that each course is laid at its proper level. As far as possible, work should proceed uniformly all over, but when that is not feasible portion of masonry to be left behind should be racked back, to the extent of half the length of block at every course. It should be ensured that all perpend are truly vertical.

4.3.4.3 To ensure good bond between blocks and mortar, the latter should not be spread too far ahead of laying of blocks, as otherwise mortar may stiffen and may not bond well with the blocks. As each block is laid, excess mortar from the joints should be scraped off with trowel and either thrown back to the mortar board (or pan) and reworked with fresh mortar or applied to the vertical side of the block just laid. Care should be taken to prevent mortar falling into the cavities of hollow blocks while laying.

4.3.5 *Jointing of Hollow Blocks*

4.3.5.1 *Horizontal joints*

Normally in load bearing walls, mortar is spread over the entire top surface of the block, that is front and rear shells and webs as a uniform layer of 10 mm thickness so as to achieve full load carrying capacity of the blocks. However, in case of non-load bearing masonry as in panels of framed structures, where load on masonry is very light, mortar may be applied only on the top of front and rear shells, and not on the webs. This results in economy in cost and also minimises possibility of moisture penetrating to the interior face of the wall.

4.3.5.2 *Vertical joints*

For vertical joints, mortar should be applied on vertical sides of the front and rear shells. This could be done either by applying mortar on the block already laid or on the one which is to be laid next. Latter method is more convenient as mortar could be applied with greater ease, by keeping the block in such a way that side to be mortared is upward and horizontal. In case of two-cell blocks, there is a slight depression on the vertical sides, which may be filled up with mortar when it considered necessary to secure greater lateral rigidity.

4.3.6 Closure Block

When laying the closure block, all edges of the opening and all four edges of the block should be buttered with mortar and carefully lowered into place, without letting the mortar fall down. If any mortar drops off, the block should be lifted back, fresh mortar applied and block reset into position.

4.4 Rendering and Other Finishes

4.4.1 External Renderings

Concrete blocks of various varieties are mostly pervious and are liable to get damp when exposed to rain. In areas of heavy and moderate rainfall, exterior surface of block masonry walls should therefore be made water-proof by plastering which should be applied only after the wall has thoroughly dried. To provide key for plastering, joints should be raked to a depth of 10 mm, while the mortar is green. Masonry surface should be lightly moistened just before application of plastering. Excessive wetting of block masonry is likely to result in shrinkage cracks in masonry on drying. Curing of plaster should also be done sparingly so that masonry does not absorb much moisture.

In areas of heavy rainfall, plastering should be done in two coats, first coat being 12 to 15 mm thick and second coat 8 to 10 mm. Mix of mortar for plaster should be 1 cement : 1 lime : 6 sand, using coarse sand (3 mm and down) and surface should be finished coarse with a wooden float. In areas of moderate rainfall, one coat of plaster 12 to 15 mm thick in cement-lime mortar 1 : 1 : 6 is adequate. In areas of scanty rainfall, it is not necessary to provide plaster, but joints should be flush pointed with cement mortar 1 : 3. For this purpose, mortar joints should be raked to a depth of 15 mm at the time of laying masonry while the mortar is green.

4.4.2 Internal Renderings

As concrete blocks generally have even and uniform surface, it is not essential to provide a rendering coat on the inside surface. Joints should, therefore, be flush pointed and surface finished in cement paint. However, when a very smooth and high class finish is desired, walls may be given one coat of plaster 8 to 10 mm thick in cement lime mortar 1 : 2 : 9, and desired finish give to the surface.

4.5 Treatment at Openings and Fixing of Door and Window Frames

4.5.1 When using hollow blocks as masonry units, either one course of masonry under window openings should be built with solid blocks or hollows of blocks in one course should be filled with cement concrete 1 : 3 : 6.

4.5.2 Jambs of large door and windows should be either built with solid blocks or hollow blocks should be filled with cement concrete 1 : 3 : 6.

4.5.3 Door and window frames should be fixed to

masonry by means of holdfasts embedded in *in-situ* cement concrete blocks (of mix 1 : 2 : 4) locations of which should correspond to locations of masonry units so that *in-situ* blocks for embedding holdfasts replace precast blocks and cutting of blocks is avoided.

4.6 Provision of Lintels

A lintel over an opening may consist of either a single reinforced precast unit or a number of precast units of U-shape provided with required reinforcement bars in the hollows and filled *in-situ* with 1 : 2½ : 3½ cement concrete.

4.7 Intersecting Walls

All walls, whenever they meet or intersect, should be bonded together by laying the courses of the two walls at the same time, providing true masonry bond between at least 50 percent of the units at the intersection. When it is not feasible to construct the two walls simultaneously, pockets in alternate courses should be left in the wall laid first and corresponding courses of second wall built into those pockets.

4.8 Provision of Floor/Roof

If hollow blocks are used in masonry, hollows of the blocks in the last course, just below the floor/roof should be filled with cement concrete 1 : 3 : 6. The top course in case of all varieties of blocks should be finished smooth with a thin coat of 1 : 3 cement mortar. After this has set and partly dried, the bearing surface should be either given a coat of crude oil or covered with craft/tarred paper to serve as a slip-joint at the bearing of the slab.

SECTION 5

5 MASONRY ELEMENTS

5.1 General

Masonry elements in common use are: wall, pillar, cavity wall, retaining wall, arch and dome. Construction of wall and pillar has been covered earlier in Sections 2, 3 and 4. Construction of other elements is given below.

5.2 Cavity Wall

5.2.1 A cavity wall is a double wall consisting of two separate leaves of masonry bonded to each other, and having a thin cavity in-between which intercepts movement of moisture from outer leaf to the inner leaf and also improves the thermal insulation of the wall. A cavity wall can be either load bearing or non-load bearing. Generally speaking, both the leaves of masonry are half brick thick, built in stretcher bond. If for architectural effect, the outer leaf has to be in "Flemish bond" it is necessary to make use of purpose made snap header, since headers made by cutting normal full length bricks do not prove to be satisfactory.

5.2.2 The outer and inner leaves of masonry are tied together by means of metallic ties, which are

embedded in the mortar joints with a slight fall towards the outer leaf so that ties may not act as a path for travel of rain water from outer leaf to the inner leaf. Wall ties may be made of galvanised mild steel bar or galvanised flat iron pieces with fish-tailed ends. Galvanising is necessary to make the mild steel rustproof. A less expensive alternative, which is not so satisfactory is to use M.S. ties which are coated with bitumen and sand. To prolong the life of galvanised M.S. ties, sometimes, these are also coated with bitumen and sand before use. Spacing of ties should be, generally, not less than 1 m horizontally and $\frac{1}{2}$ m vertically, with additional ties on the sides of openings. As far as possible, ties should be evenly distributed over the entire wall.

5.2.3 Foundation of the cavity wall should be solidly constructed like ordinary wall foundation up to 15 cm below DPC. Two leaves of masonry should be raised simultaneously and uniformly. Measures should be adopted to ensure that cavity is kept free from mortar droppings. Door and window jambs should be built solid by headers suitably bonded with the main leaves of the cavity wall. Window sills should consist of either precast concrete slabs or a header course of bricks. Lintels should be of full thickness of wall. Below the floor or roof slab there should be two courses of solid masonry. In case of non-load bearing panel walls, however, cavity may extend up to soffit of the beam. Cavity should be ventilated by use of air bricks or weep holes both at bottom and top. In areas of heavy rainfall, where it is necessary to ensure full protection from rain penetration, vertical DPC should be provided at jambs of doors and window, which are solid built. Width of cavity should be 4 cm minimum and 10 cm maximum. In case of walls having door and window openings it facilitates construction of solid portion of masonry in foundation, plinth, jambs, sills of windows and bearings of R.C.C. slabs of overall thickness of cavity wall is kept as a multiple of half-brick.

5.3 Retaining Wall

5.3.1 Function of a masonry retaining wall is to resist lateral pressure due to earth, water or some other non-cohesive material. Masonry units commonly used for retaining walls are stone and brick. Since a masonry retaining wall is designed as a gravity structure, it is preferable, on grounds of economy, to use a masonry unit of high density for a retaining wall. From this consideration, in regions where stone is available, retaining wall is normally constructed in stone.

5.3.2 From structural consideration, a retaining wall is built generally with one face vertical (the face on which lateral thrust is acting) and the other face battered. Courses of masonry instead of being horizontal are laid at a slope normal to the battered face. Foundation for retaining wall should be taken deep enough so as to be safe from the effect of scour, frost and surface water. Projections of any footing course, should not

exceed half the depth of course.

5.3.3 In case of a retaining wall, intended to resist earth pressure, it is necessary to prevent accumulation of water on the back side of the retaining wall by making suitable arrangements for quick drainage of rain water. For this purpose, a back fill of minimum width 45 cm consisting of quarry spoil, stone spalls, gravel, disintegrated rock, brick-bats or some granular material should be provided together with weep holes of size 5 to 7.5 cm square in masonry. Weep holes should be spaced at intervals of 2 m horizontally and 1 m vertically, lowest row of weep holes being 30 cm above the ground level, and their inlets should be surrounded by loose stones or some other course material. It may be mentioned that weep holes are not needed in case of dry random rubble stone masonry because water can easily drain out through the unmortared joints of such masonry. Remaining fill behind a retaining wall should be compacted in 15 cm layers, sloping way from the wall.

5.3.4 Stone Retaining Wall

5.3.4.0 Mostly stone retaining walls are built either in dry random rubble masonry or dry coursed rubble facing masonry with a backing of random rubble masonry the former in case of roads in unpopulated areas, where appearance is not of much consideration and the latter in populated areas, where appearance is an important consideration. Mortar bound stone retaining walls are generally not provided on economic considerations.

5.3.4.1 Retaining walls of dry random rubble stone masonry

Stones in the facing for this masonry should have a minimum height of 15 cm, their average breadth should not be less than height and average length not less than $1\frac{1}{2}$ times the height for stones up to 20 cm height and $1\frac{1}{3}$ times the height for stones larger than 20 cm in height. Bond stones; which should be at least 300 square centimetres in section and 80 centimetres in length should be provided at a rate of 2 per square metre of face area.

Stone in foundation should be as large as possible, and should be placed with their bed at right angles to the face better. Stones in the front and back face should be laid as headers and stretchers alternately, all stones breaking bond with stones below, as much as possible.

When it is desired to construct a retaining wall of height exceeding 3 m, it should be provided with bands of rubble masonry laid in mortar, both in the vertical as well as in the horizontal directions. In the vertical direction, bands should be of 0.5 m height at about 3 m intervals and in the horizontal direction these should be of 1 to 2 m width at about 10 m centres. Top few courses of wall should be strengthened either by laying them in mortar or by providing a

concrete coping of 15 cm depth in cement concrete 1 : 3 : 6, with control joints at 3 metre intervals and expansion joints at 10 metre intervals.

5.3.4.2 Retaining wall in dry coursed rubble facing masonry

Specification for facing is same as for coursed rubble masonry (3.3) but without any mortar in joints and backing, as laid down in 5.3.4.1.

5.3.5 Brick Retaining Wall

Brick retaining wall should be laid in cement mortar of mix 1 : 6 using coarse sand. It could be finished either by plaster or pointing, depending on architectural considerations. It is desirable that bricks should be well burnt from consideration of durability of the wall—in fact somewhat over-burnt bricks would do better. Since compressive stress in a retaining wall is generally not much, broken bricks can be used in the hearting of the wall, provided all joints are properly filled with mortar. This would, however, increase the consumption of mortar for this masonry and therefore one should carefully weigh the economy in use of broken bricks against the increase in cost of mortar.

Top of a brick retaining wall should generally be protected by a cement concrete coping of 7.5 to 10 cm thick, concrete being of 1 : 3 : 6 mix. This coping should be laid with control joints at about 3 metre intervals and expansion joints at about 10 metre intervals in order to obviate possibility of shrinkage and thermal cracks in coping.

5.4 Masonry Arches

5.4.1 General

A masonry arch is employed for horizontal spanning, that is bridging and transmitting loads from above to the sides of an opening. In building construction, arches are provided over door and window or verandah openings, mainly for architectural effect but sometimes for economy in cost in case of small spans—say up to 1 metre. Arches are of various shapes and forms; those in common use being circular (segment or semi-circle) and flat. A segmental arch generally employed is that subtending an angle of 60° at the centre. Such an arch has a rise to span ratio of 1 : 7.464. For simplicity a circular arch of rise to span ratio of 1/8 is often adopted. A semi-circular arch is a half circle so that rise in the middle is half the span. This arch has an advantage over segmental arch that side thrust at the support is much less and thus side supports need not be very wide. A flat arch, which is suitable only for small spans (say up to 1 metre) and light loads, has a horizontal extrados and slightly cambered intrados (to nullify the small amount of sag of the arch under load) is employed mainly for spanning door and window openings in ordinary buildings. Usual allowance for camber in the intrados in the flat arch is 1/100 of the span. When wooden

bresssummers are used for spanning horizontal openings, in buildings, circular arches are sometimes provided over bresssummers to serve as relieving arches for reducing masonry loads on bresssummers which otherwise would sag under excessive load. Before advent of RCC, brick arch roofing used to be a popular and economical mode of roofing for buildings.

5.4.2 Centering

Centering for an arch should be true in shape and should be sufficiently rigid so as not to yield under load. Also there should be some arrangement (for example folding wedges) for slightly easing the centering without any vibration, soon after construction of the arch, so that masonry units of the arch may bed down firmly before the mortar has finally set. Slackening of the centering, however, should not be done too soon after laying of masonry in arch, as that may squeeze out the mortar from part of the masonry laid last. For arches up to 2 m span, centering may consist of honey-combed brickwork supported on planks or battens of sufficient strength, suitably held in position. For spans between 2 to 4 m, timber centering should be used with hard wood wedges for slackening the centering. For spans exceeding 4 metres, it is desirable to use steel centering, particularly when a large number of arches of same span have to be constructed, so that repeated use of steel centerings could be made. For spans exceeding 6 metre, slackening device should consist of sand boxes.

When there are 4 spans or less, all the spans should be completely centered at one time and construction of all the arches should be commenced simultaneously. In case of a structure with more than 4 spans, there should be at least 4 sets of centerings so that a minimum of 4 spans could be centered at one time and arched over. Centering should not be struck before one week after the completion of an arch. Care should be taken to ensure that walls on the sides of an arch are built up to at least two-thirds of the height of the arch and haunches are filled up to that height, before striking of centering.

5.4.3 Construction

5.4.3.1 Masonry work in arch should be carried up from both ends uniformly and keyed in the centre. Masonry units forming skew backs should be cut or dressed so as to give proper radial bearings to the end voussoirs. Defects in dressing should not be made good by mortar or chips. The arch work should be kept thoroughly wet, so that no portion of the arch hardens and fully sets before the whole arch is completed. From this consideration, it is desirable to employ a mortar which is slow setting. In multiple arches, the key units (brick or stone) should not be inserted in any one arch till the adjacent arch or arches have been constructed to the extent of at least 25

percent for counter-acting the side thrust of the arch.

5.4.3.2 Brick arch

Brick arch may be either gauged or plain. In gauged arch, cut or moulded bricks are used and in plain arch uncut bricks are used. Joints in brick work should consist of through radial joints and voussoirs should break joints with each other. For a gauged arch thickness of radial joint should not exceed 5 mm. In case of plain arch, minimum thickness of joint should be 5 mm and maximum 15 mm. When arch face is to be pointed, face bricks should be moulded or cut to proper shape so as to have uniform face joints not more than 5 mm in thickness.

5.4.3.3 Stone arch

Stones should not be smaller than 25 cm in any direction for fine tooled ashlar arch and smaller than 20 cm in case of rough tooled ashlar arch. Stones, for arches up to 60 cm in depth, should be of full thickness of wall. For arches exceeding 60 cm but not exceeding 90 cm in depth, stones should be laid in alternate courses of headers and stretchers, all the headers being of full thickness of ring and not more than two stretchers being used to make up full thickness of a ring. For arches over 90 cm in depth, quoins and key stones only need be of full thickness of the ring. Break of joints across the depth should be not less than 20 cm. During the progress of work, care should be taken to distribute the load on centering evenly in order to obtain true curvature on completion of the arch. For ashlar masonry arch, joints should not be more than 5 mm thick and face joints should be all uniformly recessed to a depth of 20 mm.

5.4.4 Loading of Arches

Loading of arches should be gradual and so regulated that at least 7 days should elapse before 50 percent of design load and at least 14 days should elapse before 75 percent of design load comes on the arch, allowing full design load only after 28 days of completion of arch.

5.4.5 Supports

End supports that is abutments of arches should be strong enough to withstand the horizontal thrust of end arches as well as vertical loads. When constructing arched roofs, horizontal thrusts at ends on walls should be resisted with the help of mild steel tie rods. In case of multiple arches of uniform span and loadings, as there is no horizontal thrust at intermediate supports (walls or piers), normally no ties are needed, in intermediate spans.

5.5 Masonry Domes

5.5.1 Masonry domes were provided in the past to serve as roof cover for large structures, when no other structural means of bridging large spans were available. With the advent of steel,

reinforced concrete and prestressed concrete, use of domes is not made now, except on special architectural considerations in case of monumental, religious and institutional buildings.

5.5.2 Construction technique of a dome is more or less similar to that of an arch. In view of the fact that use of dome is very uncommon now, it has not been considered necessary to go into details of this technique.

SECTION 6

6 SOME MISCELLANEOUS MATTERS RELATING TO MASONRY

6.1 General

In this section, some miscellaneous matters relating to masonry not covered in earlier sections are dealt with briefly.

6.2 Chases, Recesses and Holes

Requirements of chases, recesses and holes have been covered in detail in IS 1905 : 1987.

6.2.1 Chases and recesses are provided in masonry to run services like electric supply, water supply, telephone lines, etc, and to provide space for meters and shelves. As far as possible, services should be planned with the help of vertical chases in walls, in conjunction with horizontal runs in floors and roofs and horizontal chases in walls should be avoided.

6.2.2 Vertical chases should not be closer than 2 m in any stretch of a wall. These should be kept away from bearings of beams and lintels, but if unavoidable, stress in the affected portion should be checked and kept within limits. Vertical chases should be avoided in narrow stretches of masonry such as between door and window openings. When unavoidable, such narrow stretches of wall should be built with stronger units and richer mortar or built in plain cement concrete.

6.2.3 Horizontal chases when unavoidable, should be located in the upper or lower one third of height of a storey, and no continuous horizontal chase should exceed 1 m in length.

6.2.4 For load bearing brick walls depth of vertical and horizontal chases should not exceed one-third and one-sixth of the thickness of wall respectively. No chase should be provided in a load bearing half-brick wall and chases in a one-brick load bearing wall should be provided with care so as to avoid excessive cutting and structural damage to masonry. Chases in masonry should always be cut with a sharp chisel since a blunt chisel disturbs the masonry units and weakens the masonry.

6.2.5 In brickwork, chases are normally cut, after the masonry has adequately set. However, in case of stone masonry, because of hardness of stone, this is not possible and therefore chases have to be formed by using selected and specially shaped stones while laying stones in masonry. In case of masonry with hollow concrete blocks, hollows of

blocks can be made use of for running the services.

6.2.6 Recesses in masonry of size up to 30 cm × 30 cm could be provided without a lintel, provided there is no concentrated load directly over the recess. Masonry over a recess wider than 30 cm (horizontal dimension) should be supported on a lintel. In case of circular recesses, no lintels are needed if upper half of the recess is built as an arch.

6.3 Brick Nogging and Dhajji Walling

6.3.1 In regions where timber is comparatively cheap and available in abundance, load and non-load bearing walls are sometimes built by providing a timber framework infilled with half-brick or stone masonry. This type of walling is known as brick nogging when infilling is done with bricks and dhajji walling when infilling is done with stones. Thickness of wall is generally 12 to 13 cm. Brick nogging walling is illustrated in Fig. 16.

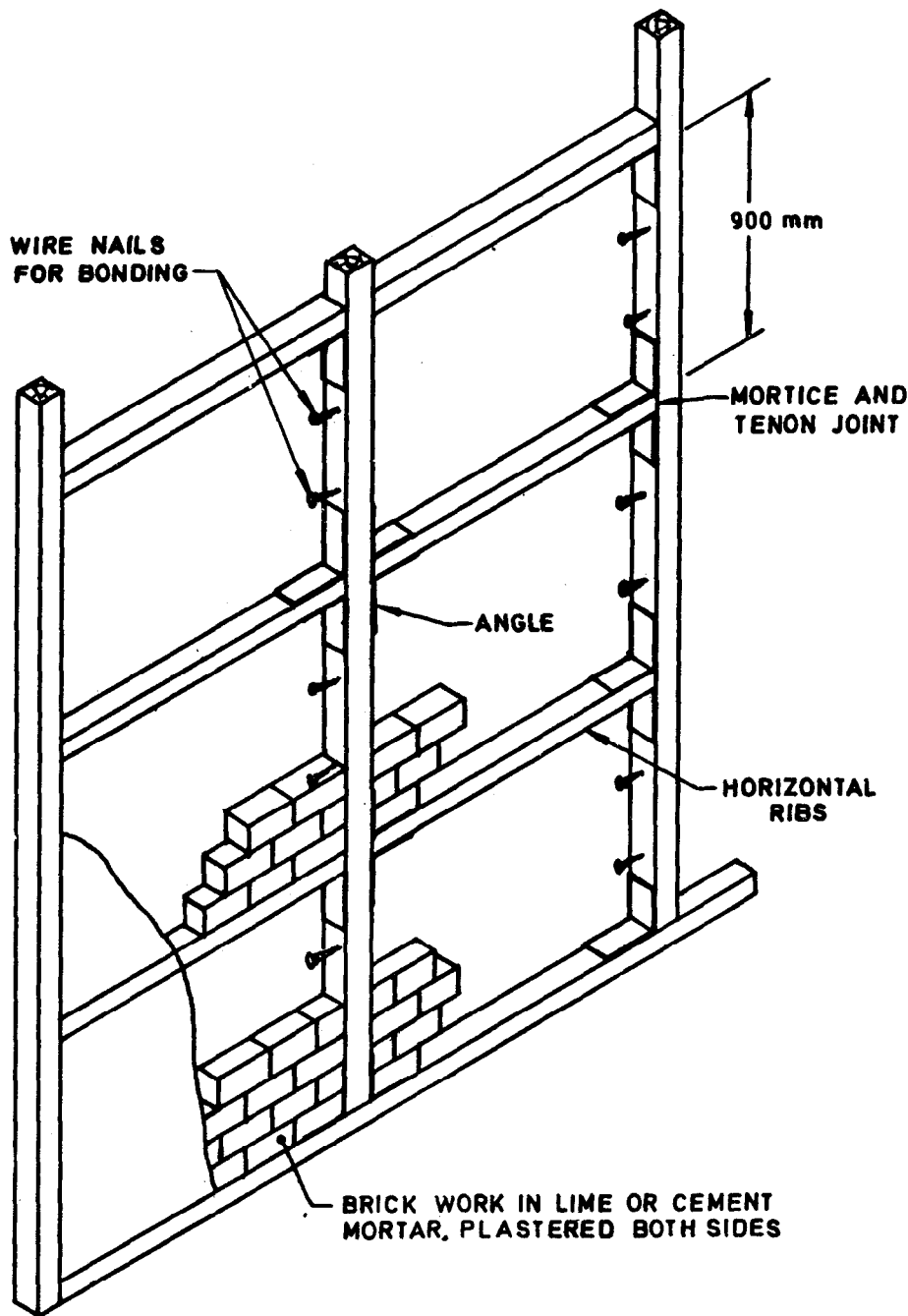

FIG. 16 TYPICAL DETAILS OF BRICKNOGGED WALLING

6.3.2 Timber framing consists of vertical posts of storey height 1 to 1.5 m apart and horizontal battens at about 1 m intervals. The battens are notched into the posts and fastened by iron spikes of about 8 mm dia. In case of dhajji walling the frame is braced by diagonals which are halved at their intersections and are fastened to the posts by means of 10 cm long wire nails. In case of brick nogging diagonals for bracing are not provided because, firstly brickwork which is laid tightly with well-filled thin joints and good quality bricks, itself serves as bracing for the frame and secondly, use of diagonals if provided, would interfere with brick laying and would considerably weaken the brickwork. In this type of walling position of doors and windows is so planned that frames for doors and windows form a part of the wall frame. Sections of various members of the frame and their spacings are determined after taking into consideration the loads on the wall, finish of the wall faces, sill level of window, lintel level of doors and windows, storey height, length of wall, size of bricks, etc. Sections commonly used are 12.5×12.5 cm for verticals, 12.5×7.5 cm for horizontals and 10×5 cm for diagonal braces.

6.3.3 Before laying of masonry, surface of timber which is to come in contact with masonry is given one or two coats of hot bitumen or some wood preservative such as sollignum.

6.3.4 Brickwork and stone masonry are anchored to the vertical posts by means of 10 cm long wire nails half driven into the posts at intervals of 3 to 4 courses or about 30 cm so that projected portions of nails get embedded in bed mortar of masonry.

6.3.5 Both faces of internal walls and inner face of external walls are generally finished in cement or lime plaster all over except at the door and window frames. In order to bond plaster to the wood surface strips of wire netting of about 1.5 cm mesh are nailed over the wood surface to be plastered. Outer face of external walls can be finished by (a) plastering over the entire surface (except frames of doors and windows); or (b) plastering over the infilling and stopping it against the frame; or (c) pointing over the infilling. In case of alternatives (b) and (c), the filling should be so laid that the frame face projects by about 3 mm beyond the plastered or pointed surface.

6.3.6 In dhajji walling, thickness of stone masonry is generally 10 to 12 cm and all stones must be through stones with flat beds laid to fit closely against the vertical posts and diagonal bracing. In hilly regions, where bricks are difficult to procure and stone is easily available, dhajji walling is adopted in preference to brick nogging.

6.3.7 Since thickness of brick nogging or dhajji walling is generally 12 to 13 cm, it does not have much thermal insulation and resistance to rain penetration. It is, therefore, not suitable for use as external wall in regions of extreme climate or

heavy rainfall. This type of walling, because of its light weight and good ductility, is well suited for earthquake prone regions.

6.4 Window Sills

It is a good practice to provide for extra strength and durability in window sills so that these do not get damaged, loosened or worn out in use. This is done by (a) laying a course of brick on edge at the sills in case of brick masonry or laying a course of headers in case of rubble stone masonry; or (b) providing a 4 to 5 cm thick layer of cement concrete, with or without terrazzo finish; or (c) laying a 4 to 5 cm thick course of stone or marble slabs. Choice of a specification for this purpose in any case would depend upon considerations of cost, type of masonry units used for walls and architectural requirements of the building.

6.5 Copings on Compound Walls and Parapets

Copings on compound walls and parapets are provided to afford protection to the top courses of masonry from weathering action due to repeated cycles of heating and cooling and rainfall, which would otherwise tend to dislodge the top courses of masonry. The coping generally consists of precast cement concrete slabs or stone slabs about 5 cm in thickness laid in suitable mortar. The coping should project about 2.5 cm on both sides of the wall faces with drips and should be provided with expansion joints about 5 mm in width at 2 to 4 m intervals. Parapet copings should slope to the rear to prevent rain washing down dust on the face of wall and spoiling it.

6.6 Use of Fire Bricks

When masonry is in immediate contact with fire as in fire places, hearths, incinerators, bakeries, ovens, etc, it will not be able to stand the intense heat and would disintegrate and get burnt out very soon. It is, therefore, necessary in such situations to provide a lining of fire bricks (see IS 1526 : 1960) laid in fire proof mortar (see IS 195 : 1963). For laying, fire bricks are simply dipped in a thin paste of well puddled fire-clay in water and laid so that joints are very thin. No lime or cement mortar should be used in masonry which is to be in contact with some source of heat. In case of ordinary residential buildings, *CHULLAHS* or cooking places could be built with common bricks laid in mud mortar and finished with mud plaster.

6.7 Flues and Chimneys in Residential Buildings

6.7.1 In residential building a flue is generally provided in kitchen (in conjunction with a hood) so as to take out smoke, hot gases, fumes, etc, from *CHULLAHS* or cooking stoves. Flue may consist of either an asbestos cement pipe of 15 cm dia encased in masonry wall or a duct formed in masonry itself. In the latter case, thickness of wall has to be at least $1\frac{1}{2}$ brick, which would give a flue of about 10×20 cm section. Masonry flue

should be laid in weak cement mortar or mud mortar and pargetted with a mix 1 cement : 1 GOBAR : 3 mud. Pargetting has to be done in small stretches as the work proceeds, since it is not possible to provide any finish to the interior of the flue, after it has been constructed to full height. During construction of a flue it is necessary to prevent mortar droppings falling into the flue and blocking it. This could be done by plugging the completed part of flue with a roll of gunny bag and shifting the plug up as the work proceeds. As a further precaution, after the completion of a flue, a core of gunny bag or old cloth tied to a long rope should be pulled through the flue to make sure that the flue is not blocked.

6.7.2 In case of multi-storeyed buildings, when there are a number of kitchens one above the other, every kitchen should have an independent flue going up to the top and flues of different kitchens should not be combined or inter-connected as otherwise smoke from one kitchen is likely to be blown into another.

6.7.3 In order to ensure good draught a flue should be more or less vertical with minimum of bends. When bends are unavoidable, as in multi-storeyed buildings having a number of kitchens one over the other, angle of bend in any flue should not be flatter than 60° to the horizontal.

6.7.4 Flues are more efficient, when provided in an internal wall. If placed in an external walls, thickness of wall on the external face of the flue should preferably be one brick but not less than half-brick so that outside low temperature in winter may not have much damping effect on the draught.

6.7.5 Flues in the form of a chimney should be carried to a height of at least 1 metre above the roof and ended into a chimney top, having side outlets and a stone or concrete slab over to prevent rain water getting into the chimney.

6.8 Protection of Masonry During Construction

6.8.1 It is necessary to protect masonry during construction when the mortar is green or when masonry has not been laterally supported, against damage due to rain, frost, storm, etc. It is also necessary to protect some vulnerable parts of masonry such as jambs, corners and sills and exposed masonry, during construction from damage due to construction activities.

6.8.2 Protection Against Rain

A heavy down-pour of rain falling on freshly laid masonry can leach out cement and lime from the mortar used for laying masonry if mortar has not sufficiently set. In the first instance, masonry work should be suspended if heavy rainfall is expected. When some masonry work has been freshly laid and rain is imminent, masonry should be covered with tarpaulins or water-proof canvas and if these are not readily available, with old gunny bags. It is only the top few courses which

need protection. This protection is needed more in case of slow setting lime or cement-lime mortars and less in case of fast setting cement mortars.

6.8.3 Protection Against Frost

As a general rule no masonry work in exposed situation should be carried out when ambient temperature is below 5°C , unless special means are adopted to heat masonry materials and to protect completed work. When there is likelihood of occurrence of frost at night, in the first instance, mortar which is quick setting, that is, mortar containing fair proportion of portland cement should be used for laying masonry (*see 1.4.3.3*). Where considered necessary, use can be made of accelerators in cement mortar so that mortar sets quickly and develops sufficient strength before occurrence of frost [*see 1.4.7.3 (d)*]. As a further precaution, day's work should be protected by covering the freshly laid masonry with tarpaulins, canvas or gunny bags. Use of air-entraining admixtures in cement mortars results in increased resistance to repeated cycles of freezing and thawing.

6.8.4 Protection Against Storm

A masonry wall is able to resist lateral forces due to wind pressure only when cross walls have been built or R.C.C. floor/roof bearing on the wall has been laid. A high wall, therefore, is liable to overturn due to wind pressure if a storm happens to occur, before the wall has been braced either by cross walls or by floor/roof slab. It is, therefore, necessary to protect an unbraced wall during construction if there is a likelihood of occurrence of a storm, with the help of adequate number of bully stays, fixed on both sides of the wall.

6.8.5 Care of Exposed Masonry

In case of masonry which is not to be plastered over and is to have exposed finish, care should be taken that mortar droppings and surface blemishes are removed soon after laying of masonry, that is, before mortar has set. It is very difficult and laborious to clean the surface of exposed masonry once mortar droppings have set and surface has been blemished.

6.8.6 Protection from Damage Due to Normal Construction Activities

Care should be taken that corners/edges and jambs and sills of openings, etc, are not damaged due to falling of materials, movement of workers, fixing and removal of scaffolding, centring and shuttering, etc. For preventing damage of this nature, it is necessary to issue suitable instructions to workers and to impress upon them the necessity of exercising due care.

6.9 Use of Reinforcement in Masonry

6.9.1 Provision of Horizontal Reinforcement

Sometimes horizontal reinforcement is provided in long half-brick partition walls in order to

increase their lateral resistance. Reinforcement for this purpose could be in the form of M.S. flat of section 3×25 mm, or M.S. round bars of 6 to 8 mm dia. Bricks for such walls should have a minimum crushing strength of 10 N/mm^2 and mortar should not be leaner than 1 cement : 4 sand. Reinforcement is generally provided in every third or fourth course. Reinforcement should have a minimum mortar cover of 15 mm in the lateral direction and 5 mm in the vertical direction. It should be securely anchored at the ends into load bearing walls. A brick wall which is exposed to rain or is likely to get wet frequently, should not be reinforced, as mild steel is likely to rust and damage the masonry in course of time. Lateral resistance of brick walls in exposed situations should, therefore, be increased where necessary by other means such as increase in thickness of wall or by providing piers or buttresses.

6.9.2 Provision of Vertical Reinforcement

Vertical reinforcement is provided in masonry at junctions and corners of walls when it is necessary to strengthen a building against seismic forces. This matter has been dealt with at some length in IS 4326 : 1976 which may be referred to for further details.

6.10 Prevention of Cracks in Masonry

Quite often, non-structural cracks occur in masonry due to causes such as drying shrinkage, thermal movement, differential strain, chemical action, settlement of soil/foundation, etc. This matter has been dealt with in details in SP 25 : 1984 which may be referred to.

6.11 Walling with Materials Other than Masonry

6.11.1 It will not be out of place to make a brief mention here of some types of wallings with materials other than masonry. These are 'Reed Walling' and 'Walls with soil cement'.

6.11.2 Reed Walling

6.11.2.1 This type of walling, which is classed as semi-permanent is provided for low cost buildings in areas, where reed for the purpose is locally available. The variety of reeds used for this construction are 'ekra' (also spelled as accra) in Assam and Arunachal Pradesh, and Sarkanda in Northern India. Reed walling, being light and ductile has a special advantage in zones of high seismicity such as Assam and Arunachal Pradesh.

6.11.2.2 For construction of reed walling a timber frame consisting of vertical and horizontal members is provided. This frame should be structurally capable of taking vertical and horizontal loads. Reeds in between the frame

members function as panels. Reeds could be used either in the form of machine made 'reed boards' nailed to the frame or as individual reeds horizontally slipped into grooves provided in the vertical timber parts. Reeds are strengthened on both sides by bamboo slips of not less than 6 mm thickness and 25 mm width at about 40 cm intervals. Reed panels are plastered (two coat - 15 mm thick) on both sides with cement mortar 1 : 6 or lime mortar so as to stiffen and protect the reed wall. For further details of this construction a reference is invited in IS 4407 : 1967 on this subject.

6.11.3 Soil Cement in-situ Construction

6.11.3.1 This type of construction is considered suitable for low cost and low height single storeyed buildings which may be permanent or semi-permanent, in areas where soil suitable for soil cement construction is locally available. Soil for this type of construction should have a minimum sand content of 35 percent. Black cotton soil and soils containing large proportion of plastic clay are not suitable for this type of construction. Maximum dry density of soil should not be less than 1.8 g/cm^3 . Walls made with soil cement could be either load bearing or non-load bearing. In the former case, minimum thickness should be 30 cm and in the latter case 20 cm.

6.11.3.2 Cement content of soil generally for this type of construction is 2.5 to 3.5 percent. Proportion of cement for any particular soil is decided after carrying out laboratory tests so that compressive strength of soil cement is not less than 1.4 N/mm^2 in dry condition and 0.7 N/mm^2 in saturated condition. Total quantity of water in the soil cement mix is kept at optimum moisture level as determined by Proctor Test so as to achieve maximum dry density.

6.11.3.3 Selected soil is thoroughly pulverized and stacked to a height of 30 cm. Requisite quantity of cement is uniformly spread over the stack and soil and cement are mixed by spading and again stacked to original height. Requisite quantity of water is then added and wet mixing done to such portion of the stack as can be laid in wall and compacted within $\frac{1}{2}$ an hour of addition of water. Soil cement mix is laid in 75 mm layers and well compacted in position with the help of proper shuttering for a lift of 60 cm at a time. The walls should be cured for 15 days after removal of shuttering and after drying for at least 4 weeks, finished with plaster 12 mm thick on both sides with cement mortar (1 : 5).

6.11.3.4 For fuller details in regard to *in-situ* construction of soil-cement walls a reference is invited to IS 2110 : 1960.

As in the Original Standard, this Page is Intentionally Left Blank

LIST OF REFERENCES AND BIBLIOGRAPHY

1. Central Public Works Department Specifications—Vol. I-1977.
2. Rajasthan Public Works Department (B&R) Specification and Explanatory Notes Vol. I-1968.
3. P.W.D. Handbook, Bombay Vol. I-1968.
4. MES Standard Schedule of Rates (Part I—Specification)—1970.
5. Punjab P.W.D. Specification—1963 (Reprint 1980).
6. Madras Detailed Standard Specification—1956 (Reprint 1964).
7. Building Research Note No. 7 of CBRI, Roorkee.
8. Building Construction Parts I & II by George A. Mitchell—1944.
9. Principles of Modern Building Vol. I and II—1961.
10. Building Construction Vol. I by W. B. MCKAY Second Edition—1943.
11. IS 2116 : 1980 Specification for sand for masonry mortars (*first revision*).
12. IS 1344 : 1981 Specification for calcined clay for pozzolana (*second revision*).
13. IS 3812 : 1981 Specification for fly ash for use as pozzolana and admixture (*first revision*).
14. IS 712 : 1973 Specification for building limes (*second revision*).
15. IS 269 : 1976 Specification for ordinary and low heat portland cement (*third revision*).
16. IS 455 : 1976 Specification for portland slag cement (*third revision*).
17. IS 1489 : 1976 Specification for portland pozzolana cement compounds (*second revision*).
18. IS 3466 : 1967 Specification for masonry cement (*first revision*).
19. IS 6452 : 1972 Specification for high alumina cement for structural use.
20. IS 6909 : 1973 Specification for super-sulphated cement.
21. IS 8112 : 1976 Specification for high strength ordinary portland cement.
22. IS 2645 : 1975 Specification for integral cement water-proofing compounds (*first revision*).
23. IS 4098 : 1983 Specification for lime-pozzolana mixture (*first revision*).
24. IS 1077 : 1976 Specification for common burnt clay building bricks (*third revision*).
25. IS 2180 : 1970 Specification for heavy-duty burnt clay building bricks (*first revision*).
26. IS 4885 : 1968 Specification for sewer bricks.
27. IS 2222 : 1979 Specification for burnt clay perforated building bricks (*second revision*).
28. IS 3952 : 1978 Specification for burnt clay hollow blocks for walls and partitions (*first revision*).
29. IS 3620 : 1979 Specification for laterite stone block for masonry (*first revision*).
30. IS 2185 (Part 1) : 1979 Specification for concrete masonry units: Part 1 Hollow and solid concrete blocks (*second revision*).
31. IS 2185 (Part 2) : 1984 Specification for concrete masonry units: Part 2 Hollow and solid light weight concrete blocks (*first revision*).
32. IS 2185 (Part 3) : 1984 Specification for concrete masonry unit: Part 3 Autoclaved cellular (aerated) concrete blocks (*first revision*).
33. IS 3115 : 1978 Specification for lime based blocks (*first revision*).
34. IS 1725 : 1982 Specification for solid based blocks used in general building construction (*first revision*).
35. IS 4139 : 1976 Specification for sandlime bricks (*first revision*).
36. IS 2849 : 1983 Specification for non-load bearing gypsum partition blocks (solid and hollow types) (*first revision*).
37. IS 1128 : 1974 Specification for limestone (slab and tiles) (*first revision*).
38. IS 1130 : 1969 Specification for marble (blocks, slabs and tiles).
39. IS 3622 : 1977 Specification for sandstone (slabs and tiles) (*first revision*).
40. IS 2212 : 1962 Code of practice for brickwork.
41. IS 1597 (Part 1) : 1967 Code of practice for construction of stone masonry: Part 1 Rubble stone masonry.
42. IS 2572 : 1963 Code of practice for construction hollow concrete block masonry.
43. IS 6041 : 1971 Code of practice for construction of autoclaved cellular concrete block masonry.
44. IS 6042 : 1969 Code of practice for construction of light weight concrete block masonry.
45. IS 4101 (Part 1) : 1967 Code of practice for external facings and veneers: Part 1 Stone facing.
46. IS 4101 (Part 2) : 1967 Code of practice for external facings and veneers: Part 2 Cement concrete facing.
47. IS 4101 (Part 3) : 1969 Code of practice for external facings and veneers: Part 3 Wall tiling and mosaics.
48. IS 4407 : 1967 Code of practice for reed walling.

49. IS 2110 : 1980 Code of practice for *in-situ* construction of walls in buildings with soil-cement (*first revision*).
50. IS 1969 : 1968 Method for determination of breaking load and elongation at break of woven textile fabrics.
51. IS 1905 : 1986 Code of practice for structural use of unreinforced masonry (*third revision*).
52. IS 4326 : 1976 Code of practice for earthquake resistant construction of buildings (*first revision*).
53. IS 3696 (Part 1) : 1966 Specification for safety code for scaffolds and ladders: Part 1 Scaffolds.
54. IS 2750 : 1964 Specification for steel scaffoldings—BIS.
55. SP 21 : 1983 Summary of Indian Standards for Building Materials—BIS.
56. SP 25 : 1984 Causes and Prevention of Cracks in Buildings—BIS.
57. BS CP 121 : 202 (1951) Masonry—Rubb Walls.—British Standards Institution.
58. BS CP 121 : Part 1 (1973) Brick and Block Masonry—British Standards Institution.