

**MANUAL OF  
SPECIFICATIONS & STANDARDS  
FOR FOUR LANING  
OF HIGHWAYS THROUGH  
PUBLIC PRIVATE PARTNERSHIP**

*(First Revision)*



**INDIAN ROADS CONGRESS  
2014**



Digitized by the Internet Archive  
in 2014

<https://archive.org/details/govlawiracy2014sp84>

**MANUAL OF SPECIFICATIONS & STANDARDS  
FOR FOUR LANING OF  
HIGHWAYS THROUGH  
PUBLIC PRIVATE PARTNERSHIP**

***(First Revision)***

***Published by:***

**INDIAN ROADS CONGRESS**

Kama Koti Marg,  
Sector-6, R.K. Puram,  
New Delhi-110 022

**August, 2014**

Price : ₹ 1000/-  
*(Plus Packing & Postage)*

IRC:SP:84-2014

First Published : October, 2009  
Reprinted : March, 2010  
First Revision : August, 2014

*(All Rights Reserved. No part of this publication shall be reproduced, translated or transmitted in any form or by any means without the permission of the Indian Roads Congress)*

Printed by India Offset Press, Delhi-110 064

1000 Copies

# CONTENTS

Sl. No.	Description	Page Nos.
	Personnel of the General Specifications and Standards Committee (GSS)	i
	Introduction	1
	<b>Section - 1 : GENERAL</b>	<b>2</b>
	<b>Section - 2 : GEOMETRIC DESIGN AND GENERAL FEATURES</b>	<b>9</b>
2.1	General	9
2.2	Design Speed	9
2.3	Right-of-Way	10
2.4	Lane Width of Carriageway	10
2.5	Median	10
2.6	Shoulders	11
2.7	Roadway Width	12
2.8	Crossfall	13
2.9	Geometric Design	13
2.10	Lateral and Vertical Clearance at Underpasses	14
2.11	Lateral and Vertical Clearance at Overpasses	15
2.12	Access to Project Highway	15
2.13	Grade Separated Structures	16
2.14	Median Openings	21
2.15	Separator, Footpath and Drain in Built-up Areas	22
2.16	Utility Corridor	22
2.17	Typical Cross-sections	22
2.18	Capacity of Four-Lane Highway	28
2.19	Warrants for Six-Laning	28
	<b>Section - 3 : INTERSECTIONS AND GRADE SEPARATORS</b>	<b>29</b>
3.1	Introduction	29
3.2	At-Grade Intersections	29
3.3	Grade Separated Intersections and Interchanges	34
3.4	Detailed Design and Data for Review by the IE	41
	<b>Section - 4 : EMBANKMENT &amp; CUT SECTIONS</b>	<b>42</b>
4.1	General	42
4.2	Embankment	42
4.3	Roadway in Cutting	43
4.4	Soil Investigations and Design Report	43

Sl. No.	Description	Page Nos.
<b>Section - 5 : PAVEMENT DESIGN</b>		<b>46</b>
5.1	General	46
5.2	Type of Pavement	46
5.3	Method of Design - New Pavements	46
5.4	Design Requirements for New Pavement Sections	47
5.5	Design Traffic	48
5.6	Sub-grade	49
5.7	Pavement Components and Materials	49
5.8	Performance Evaluation	49
5.9	Strengthening of Existing Pavements	49
5.10	Paved Shoulders and Paved Median Strips	51
5.11	Construction, Workmanship and Quality of Works	51
5.12	Premature Distress	51
5.13	Detailed Design Report	51
<b>Section - 6 : HIGHWAY DRAINAGE</b>		<b>53</b>
6.1	General	53
6.2	Surface Drainage	53
6.3	Median Drainage	54
6.4	Drainage where Embankment height is more than 6 m	54
6.5	Catch Water Drains	54
6.6	Sub-surface Drains	54
6.7	Internal Drainage of Pavement Structure	56
6.8	Drainage for Structures	56
6.9	Existing Drains, Canals and Minor Waterways	57
6.10	Survey, Investigation and Design Report	58
<b>Section - 7 : DESIGN OF STRUCTURES</b>		<b>59</b>
7.1	General	59
7.2	Design Loads and Stresses	59
7.3	Width of Structures	60
7.4	Structure Types	61
7.5	Hydrology	67
7.6	Sub-Soil Investigations	67
7.7	Culverts and Bridges using Pipes	68
7.8	Temporary Works	68
7.9	Foundations and Sub-Structures	69
7.10	Approach Slabs	70
7.11	Superstructures	70
7.12	Bearings	71

Sl. No.	Description	Page Nos.
7.13	Expansion Joints	72
7.14	Wearing Coat	72
7.15	Reinforced Earth Retaining Structures	72
7.16	River Training and Protective Works	73
7.17	Safety Barriers	73
7.18	Rail-Road Bridges	74
7.19	Grade Separated Road Structures	75
7.20	Drainage	75
7.21	Structures in Marine Environment	75
7.22	Repairs and Strengthening	75
7.23	Design Report	77
7.24	Responsibility for Design and Structural Adequacy	77
<b>Section - 8 : MATERIALS</b>		78
8.1	General	78
<b>Section - 9 : TRAFFIC CONTROL DEVICES, ROAD SAFETY DEVICES/ROAD SIDE FURNITURE</b>		79
9.1	General	79
9.2	Road Signs	79
9.3	Road Markings	85
9.4	Road Delineators	87
9.5	Reflective Pavement Markers (Road Studs)	87
9.6	Traffic Impact Attenuators	90
9.7	Road Side and Median Safety Barriers	92
9.8	Road Boundary Stones (RBS)	109
9.9	Work Zone Traffic Management Plans (WTMPs)	110
<b>Section - 10 : TOLL PLAZAS</b>		118
10.1	General	118
10.2	Location of Toll Plaza	118
10.3	Land for Toll Plaza	118
10.4	Layout and Design of Toll Plaza	118
10.5	Report to be submitted	127
<b>Section - 11 : LANDSCAPING AND TREE PLANTATION</b>		128
11.1	General	128
11.2	Design Considerations in Various Locations	128
11.3	Landscape Treatment	130
11.4	Report to be submitted	130
<b>Section - 12 : PROJECT FACILITIES</b>		131
12.1	General	131
12.2	Pedestrian Facilities	131
12.3	Street Lighting	131

<b>Sl. No.</b>	<b>Description</b>	<b>Page Nos.</b>
12.4	Truck Lay-byes	132
12.5	Bus Bays and Passenger Shelters	133
12.6	Rest Areas	137
12.7	Cattle Crossings	137
12.8	Highway Patrol Unit(s)	137
12.9	Emergency Medical Services	138
12.10	Crane Services	139
12.11	Communication System	140
12.12	Advanced Traffic Management Systems (ATMS)	140
12.13	Operation and Maintenance Centre	140
12.14	Report to be submitted	140
<b>Section - 13 : SPECIAL REQUIREMENTS FOR HILL ROADS</b>		141
13.1	General	141
13.2	Set Back Distance at Horizontal Curves	141
13.3	Grade Compensation at Curves	142
13.4	Hairpin Bends	142
13.5	Climbing Lane	142
13.6	Rock Blasting	142
13.7	Cut Slopes	142
13.8	Tunnels	142
13.9	Drainage	142
13.10	Retaining Walls	143
13.11	Aprons etc.	143
13.12	Disposal of Debris	143
13.13	Report to be Submitted	143
<b>Section - 14 : TUNNELS</b>		144
14.1	General	144
14.2	Geometrics	144
14.3	Geotechnical Investigations	150
14.4	Structural Design	150
14.5	Design of Drainage System	150
14.6	Waterproofing	151
14.7	Ventilation	151
14.8	Tunnel Illumination	151
14.9	Tunnel Furnishing	152
14.10	Signages and Carriageway Markings	152
14.11	Emergency Facilities	152
14.12	Safety During Construction	156
	<b>Appendix 1</b>	157 to 166
	<b>Appendix 2</b>	167 to 168

---



## PERSONNEL OF THE GENERAL SPECIFICATIONS AND STANDARDS COMMITTEE (GSS)

**(As on 6<sup>th</sup> January, 2014)**

- |    |                                    |  |
|----|------------------------------------|--|
| 1. | Kandasamy, C.<br>(Convenor)        | Director General (RD) & Spl. Secretary, Ministry of Road Transport & Highways, New Delhi |
| 2. | Patankar, V.L.<br>(Co-Convenor)    | Addl. Director General, Ministry of Road Transport & Highways, New Delhi                 |
| 3. | Kumar, Manoj<br>(Member Secretary) | Chief Engineer (R) (S&R), Ministry of Road Transport & Highways, New Delhi               |

### ***Members***

- |     |                    |  |
|-----|--------------------|--|
| 4.  | Dhodapkar, A.N     | Chief Engineer (Retd.), MORTH, New Delhi   |
| 5.  | Das, S.N.          | Addl. Director General, MORT&H, New Delhi  |
| 6.  | Datta, P.K.        | Director-Corporate Development, M/s TransAsia Infrastructure Pvt. Ltd., New Delhi                |
| 7.  | De, Dr. D.C.       | Executive Director, Consulting Engineering Services (India) Pvt. Ltd., New Delhi                 |
| 8.  | Duhsaka, Vanlal    | Chief Engineer, PWD Highways, Aizwal   |
| 9.  | Joshi, L.K.        | Vice Chairman, Central Administrative Tribunal, New Delhi  |
| 10. | Kadiyali, Dr. L.R. | Chief Executive, L.R. Kadiyali & Associates, New Delhi   |
| 11. | Kumar, Ashok       | Chief Engineer (Retd.), Ministry of Road Transport & Highways, New Delhi                         |
| 12. | Kumar, Dr. Kishor  | Chief Scientist, CRRI, New Delhi   |
| 13. | Mandpe, P.S.       | Chief Engineer (NH), PWD Maharashtra   |
| 14. | Narain, A.D.       | Director General (RD) & AS (Retd.), MOST, Noida  |
| 15. | Pandey, I.K.       | Chief General Manager (Tech.), NHAI, New Delhi   |
| 16. | Patwardhan, S.V.   | Managing Director, Madhucon Project, New Delhi   |
| 17. | Puri, S.K.         | Director General (RD) & Spl. Secretary, MoRT&H (Retd.), New Delhi                                |
| 18. | Rajoria, K.B.      | Engineer-in-Chief (Retd.), Delhi PWD, New Delhi  |
| 19. | Rao, P.R.          | Vice President, Soma Enterprises Ltd., Gurgaon   |
| 20. | Raju, Dr. G.V.S.   | Engineer-in-Chief (R&B), Rural Roads, Director Research & Consultancy, Hyderabad, Andhra Pradesh |

21.	Selot, Anand	Former Engineer-in-Chief, PWD Madhya Pradesh
22.	Sharma, D.C.	Sr. Principal Scientist and Head Instrumentation Division, CRRI, New Delhi
23.	Sharma, D.D.	Chairman, M/s D2S Infrastructure Pvt. Ltd, New Delhi
24.	Sharma, Rama Shankar	Chief Engineer (Retd.), MoRT&H, New Delhi
25.	Sharma, S.C.	Director General (RD) & AS (Retd.), MORT&H, New Delhi
26.	Shrivastava, Palash	Director, IDFC, New Delhi
27.	Singh, Nirmal Jit	Director General (RD) & Spl. Secretary, MoRT&H (Retd.), New Delhi
28.	Sinha, A.V.	Director General (RD) & Spl. Secretary, MoRT&H (Retd.), New Delhi
29.	Sinha, N.K.	Director General (RD) & Spl. Secretary, MoRT&H (Retd.), New Delhi
30.	Tamhankar, Dr. M.G.	Director-Grade Scientist (SERC-G) (Retd.), Navi Mumbai
31.	Tandon, Prof. Mahesh	Managing Director, Tandon Consultants Pvt. Ltd.
32.	Vasava, S.B	Chief Engineer (P) & Addl. Secretary, R&B Deptt. Gandhinagar, Gujarat
33.	Velayutham, V.	Director General (RD) & Spl. Secretary, MoRT&H (Retd.), New Delhi
34.	Verma, Maj. V.C.	Executive Director-Marketing, Oriental Structure Engineers Pvt. Ltd., New Delhi
35.	Rep of NRRDA	(Pateriya, Dr. I.K.) Director (Technical ), NRRDA NBCC Tower, Bhikaji Cama Place, New Delhi
36.	The Dy. Director General	(Lal, B.B.) Chief Engineer, DDG D&S Dte. Seema Sadak Bhawan, New Delhi
37.	The Chief Engineer (NH)	PWD Jaipur (Rajasthan)

***Ex-Officio Members***

1.	President, IRC and Director General (Road Development) & Special Secretary,	(Kandasamy, C.), Ministry of Road Transport & Highways, New Delhi
2.	Secretary General,	(Prasad, Vishnu Shankar), Indian Roads Congress, New Delhi

## INTRODUCTION

IRC:SP:84-2009 “Manual of Specifications and Standards for Four Laning of Highways through Public Private Partnership” was first published in 2009. The Project Preparation, Contract Management & Quality Assurance Committee (G-1) felt the necessity to revise this document and constituted a sub-group comprising of S/Shri M.P. Sharma, L.P. Padhy, R.S. Sharma, Ashok Kumar, A.K. Banerjee, S.V. Patwardhan, Ashok Bhasin & Jacob George. The G-1 Committee approved the draft document in its meeting held on 21<sup>st</sup> September, 2013 for placing before the General Specifications & Standards Committee (GSS). The GSS Committee in its meeting held on 6<sup>th</sup> January, 2014 approved this document. The Executive Committee in its meeting held on 9<sup>th</sup> January, 2014 considered and directed IRC secretariat to place the documents approved by the GSS Committee before the Council for consideration and approval. The Council in its 201<sup>st</sup> meeting held at Guwahati (Assam) on 19<sup>th</sup> January, 2014 approved the draft revision of IRC:SP:84 “Manual of Specifications & Standards for Four Laning of Highways through Public Private Partnership” after taking on board the comments offered by the Members.

The Composition of Project Preparation, Contract Management and Quality Assurance Committee (G-1) is as given below:

Puri, S.K.	.....	Convenor
Datta, P.K.	.....	Co-Convenor
Ramana, K.Venkata	.....	Member-Secretary

### **Members**

Agarwal, Varun	Mahalaha, R.S.
Bahadur, A.P.	Nirmal, S.K.
Banerjee, A.K.	Padhy, L.P.
Bhasin, Col. A.K.	Pandey, R.K.
Chakrapani, R.	Patwardhan, S.V.
Chand, Faqir	Rao, P.R.
Dasgupta, M.K.	Reddy, K. Siva
Gajria, Maj. Gen. K.T.	Sarin, A.K.
Ganesan, K.R.S.	Sharma, M.P.
Gupta, D.P.	Sharma, R.S.
Kumar, Ashok	Shrivastava, Palash
Kumar, Ashwini	Singh, Atar

Sinha, N.K.

### **Ex-Officio Members**

President, IRC and Director General (Road Development) & Special Secretary	(Kandasamy, C.), Ministry of Road Transport and Highways
Secretary General	(Prasad, Vishnu Shankar), Indian Roads Congress

## SECTION – 1

### GENERAL

**1.1** This Manual is applicable for Four Laning of Highways through Public Private Partnership (PPP) mode. The general planning aspects laid out in this manual shall be applicable for widening from 2-lane to 4-lane or new construction of 4-lane highways. The scope of the work shall be as defined in the Concession Agreement. This Manual shall be read harmoniously with the intent of the Concession Agreement. The Manual may also be used for non-PPP projects

**1.2** The Project Highway and the project facilities shall conform to the requirements of design and specifications set out in this Manual, which are the minimum prescribed. The project report and other information provided by the Authority shall be used by the Concessionaire only for its own reference and for carrying out further investigations. The Concessionaire shall be solely responsible for undertaking all the necessary surveys, investigations and detailed designs in accordance with good industry practice and due diligence, and shall have no claim against the Authority for any loss, damage, risk, costs, liabilities or obligations arising out of or in relation to the project report and other information provided by the Authority.

**1.3** At least 2 weeks prior to commencement of the work, the Concessionaire shall draw up a Quality Assurance Manual (QAM) covering the Quality System (QS), Quality Assurance Plan (QAP) and documentation for all aspects of the bridge and road works and send three copies of each to the Independent Engineer (IE) for review. The class of quality assurance shall not be less than Q-3 (Refer IRC:SP:47 and IRC:SP:57).

**1.4** The Codes, Standards and Technical Specifications applicable for the design and construction of project components are:

- i) Indian Roads Congress (IRC) Codes and Standards.
- ii) Specifications for Road and Bridge Works issued by the Ministry of Road Transport & Highways (MORTH) hereinafter referred to as MORTH or Ministry's Specifications.
- iii) Any other standards referred to in the Manual and any supplement issued with the bid document.

**1.5** Latest version of the Codes, Standards, Specifications, etc. notified/published at least 60 days prior to the last date of bid submission shall be considered applicable.

**1.6** The terms 'Ministry of Surface Transport', 'Ministry of Shipping, Road Transport & Highways' and 'Ministry of Road Transport and Highways' or any successor or substitute thereof shall be considered as synonymous.

**1.7** The terms 'Inspector' and 'Engineer' used in MORTH Specifications shall be deemed to be substituted by the term "Independent Engineer" to the extent it is consistent with the provisions of the Concession Agreement and this Manual. The role of the Independent Engineer shall be as defined in the Concession Agreement.

**1.8** In case of any conflict or inconsistency in the provisions of the applicable IRC Codes, Standards or MORTH Specifications, the provisions contained in this Manual shall apply.

**1.9** This Manual generally provides for design and construction as per Codes, Standards, Specifications, Guidelines, etc. as published by IRC, MORTH and BIS for road and bridge works. Where the Concessionaire intends to use an alternative to these Standards and Guidelines for delivering an equal or better product, he shall be permitted to use such alternative subject to the following conditions:

- i) He shall demonstrate that the proposed alternative conforms to any of the following International Standards, Codes of Practice, Specifications, Guidelines, etc.
  - a) IRC revised codes or new codes or amendments to existing codes which are effective after the date of calling of bid
  - b) American Association of State Highway and Transportation Officials (AASHTO)
  - c) American Society for Testing of Materials (ASTM)
  - d) Euro Codes
  - e) National Standards of any of the following countries: United States of America (USA), Canada, United Kingdom (UK), France, Germany, Sweden, Denmark, Norway, Netherlands, Spain, Australia, New Zealand, Japan and South Africa.
- ii) In case the Concessionaire intends to use any alternative material, technology/method, whether patented or otherwise, that is not specifically covered in the Indian or International Standards as listed above, but the use of which has been permitted on similar projects (similar in category of road, traffic and climatic conditions) as the Project Highway, he would be permitted its use on certification by the owners of such similar projects regarding the continued successful performance of such materials, technologies, methods, procedures or processes for at-least 5 years of the service life of the project. Such a certification shall be supported with details of critical performance parameters.

**1.10** All items of building works shall conform to Central Public Works Department (CPWD) Specifications for Class 1 building works and standards given in the National Building Code (NBC). For the Project Highway through the state entity, to the extent specific provisions for building works are made in IRC/MORTH Specifications, the same shall prevail over the CPWD/NBC provisions. For this purpose, building works shall be deemed to include toll plaza complex, road furniture, roadside facilities, landscape elements and/or any other works incidental to the building works.

### **1.11 Alternative Standards and Specifications**

Where alternative standards and specifications are intended to be used in accordance with Para 1.9, all such proposals shall be submitted by the Concessionaire to the Independent Engineer together with certification and details mentioned in Para 1.9. In case, the Independent Engineer is of the opinion that the proposal submitted by the Concessionaire is not in conformity with any of the International Standards or Codes or evidence by successful performance, then he will record his reasons and convey the same to the Concessionaire for compliance. A record shall be kept by the Independent Engineer, of non-compliance, if any, by the Concessionaire. Adverse consequences, if any arising from adoption of any such alternative proposals shall be treated as “Concessionaire Default” and shall be dealt in accordance with the provisions of the Concession Agreement.

### **1.12 Guidelines for Preparing Schedules of the Concession Agreement**

Certain paras (fully or part) in Sections 1 to 14 of this Manual refer to the Schedules of the Concession Agreement. While finalizing the feasibility/project report for the Project Highway, and the scope of the project, each of these paras should be carefully examined and addressed by the Authority with a view to making appropriate provisions in the Schedules of the Concession Agreement.

### **1.13 General considerations for Planning, Design and Construction**

The Project Highway shall be planned as a “partially access controlled highway” where access to the highway shall be provided only at pre-determined locations. In doing so, the Concessionaire shall take measures to overcome the physical and operational constraints and plan, design and construct the Project Highway using appropriate methods, management techniques and technologies. The objective therefore is to construct a 4-lane highway for all road users as an active infrastructure facility for people for their safety and services and as a catalyst in development of economy based on an inclusive approach.

General considerations shall, without being limited to, be as follows:-

#### **a) The constraints**

The physical constraints in the existing highway are in the form of limitation of right of way, un-regulated access, inadequate service roads and underpasses, numerous at-grade junctions, lack of physical separation between local and through traffic etc. The operation constraints arise out of the necessity or possibility of closing a portion of the road for construction and/or diverting the traffic to temporary diversions, thereby reducing the capacity and safety of the existing highway. The solutions evolved by the Concessionaire shall be such that these operational constraints are overcome through appropriate planning, design and construction method, techniques and technologies and by adopting suitable traffic management measures.

**b) Safety of design**

All designs shall be safe to ensure that the Project Highway or any part thereof (for example embankment, pavement, retaining structures, bridges, culverts, etc) does not collapse (global stability) nor its serviceability/performance (for example settlement, roughness, undulations, deflections, etc) deteriorates below acceptable level as prescribed in Schedule 'K' of the Concession Agreement.

**c) Durability**

The Project Highway shall not only be safe but also durable. This would mean that the deteriorating effects of climate and environment (for example wetting and drying, freezing and thawing, if applicable, temperature differences, aggressive environment leading to corrosion, etc.) in addition to the traffic shall be duly considered in design and construction to make the Project Highway durable.

**d) Mitigating disruptive effects of construction**

The planning, design and construction of the highway shall be such that the construction of Project Highway does not have adverse impact on the environment and does not disrupt the lives and business activities of the people living close to the Project Highway.

**1.14 Safety during Construction and Operation & Maintenance**

**1.14.1** The Concessionaire shall develop, implement and administer a surveillance and safety programme for providing a safe environment on or about the Project Highway, and shall comply with the safety requirements set forth in the Concession Agreement.

**1.14.2** Before taking up any construction or maintenance operation/work, the Concessionaire shall prepare a Traffic Management Plan for each work zone and furnish it to the Independent Engineer for comments duly incorporating the following:

- i) Designate a Site Safety Team headed by a qualified Safety Officer.
- ii) Traffic safety devices as per IRC:SP:55 with the following Specifications:
  - a) Signages of retro-reflective sheet of high intensity grade.
  - b) Delineators in the form of cones/drums (300 to 500 mm dia and 1000 mm high) made of plastic/rubber having retro reflective red and white band, at a spacing of maximum 5 m along with a reflective tape (red and white band) to be tied in between the gaps of cones/drums. A bulb/flasher using solar energy is to be placed on the top of the cone/drum for night delineation.
  - c) Barricades using iron sheet (plain) with adequate iron railing/frame painted with retro-reflective paint in alternate black and white (or yellow

and black) stripes. Warning lights at 5.0 m spacing shall be mounted on the barricades and kept lit in the dark hours and night.

- iii) The arrangement of traffic during construction and maintenance shall conform to the requirements of IRC:SP:55, Clause 112 of MORTH Specifications and provisions of the Concession Agreement. During the construction period, the Concessionaire shall maintain, at its cost, the existing lane(s) of the Project Highway or divert the traffic on to an alternative route-diversion road so that the operating width and safety standards shall be equal to those of existing lanes (excluding paved shoulders, if any) for each direction. The crust of such alternative route/diversion road shall be provided for minimum 10 msa. The drainage of existing road and construction zone during construction shall be given special attention by the Concessionaire. Prior to commencement of construction works, the Concessionaire shall submit to the Independent Engineer, the detailed construction methodology to meet the aforesaid requirement including temporary drainage plan of existing road and construction zone.
- iv) Sprinkling of water for dust control at work zones, haul roads and plant camp sites.
- v) Noise/Pollution suppression measures at work zones, haul roads and plant/camp sites.
- vi) Mechanical, electrical and fire safety practices.
- vii) Safety measures like PPE (Personal Protection Equipment) for workers engaged.
- viii) First Aid and Emergency Response Arrangements i.e. First Aid Box, Ambulance, paramedical staff, alarms, etc.
- ix) Safety training/awareness programmes.
- x) Formats to maintain the accident records/emergency response provided during accidents.

**1.14.3** The Concessionaire shall also be responsible for ensuring compliance of all labour laws and regulations including those relating to the welfare of workers engaged both directly and indirectly on the Project Highway, besides their occupational safety and health.

**1.15** The Concessionaire shall set up field laboratory for testing of materials and finished products as stipulated in Clause 120 of MORTH Specifications. It shall make necessary arrangements for additional/confirmatory testing of any materials/products at the government accredited laboratory, for which facilities at site laboratory are not available.

### **1.16 Environment Mitigation Measures**

The Concessionaire shall carry out tests/monitor various parameters impacting the environment of the Project Highway keeping in view the guidelines of the Ministry of Environment and Forests and submit proposals for mitigation of adverse environment impact



including provision of noise barriers, etc. for review and comments of the IE, if any and undertake implementation of the proposals in consultation with the IE. The type and locations of the Noise Barriers shall be specified in Schedule 'B'.

### **1.17 Utilities**

The details of the new-utilities which are to be constructed or provided for along or across the Project Highway shall be as specified in Schedule 'B' of the Concession Agreement. The Concessionaire shall be responsible for protection of the existing utilities on the Project Highway that are not required to be shifted.

### **1.18 Review and Comments by the Independent Engineer**

In cases where the Concessionaire is required to send any drawings or documents to the Independent Engineer for review and comments, and in the event such comments are received by the Concessionaire, it shall duly consider such comments in accordance with the Concession Agreement and Good Industry Practice for taking appropriate action thereon. The correspondence between the Concessionaire and the Independent Engineer shall be deemed valid only if a copy thereof is endorsed to and received by the Authority.

### **1.19 Definitions and Interpretation**

**1.19.1** Unless specified otherwise in this Manual, the definitions contained in the Concession Agreement shall apply.

**1.19.2** Built-up-area shall mean sections of the Project Highway that are situated within the municipal limits. Sections of 200 m or more in non-municipal areas where permanent structures are built on one or both sides of the Project Highway on at least 50 percent of the total length comprising such section shall also be treated as built up area. The Built up areas shall be as specified in Schedule 'B' of the Concession Agreement.

Rural areas are synonymous to non-built-up areas and urban areas are synonymous to built-up areas for the purpose of deciding various provisions given in this Manual.

**1.19.3** The definition of PCU used in this Manual shall be as per IRC Codes and Guidelines.

### **1.20 Grade Separated Structures**

- i) The structures through which the traffic flows at different levels are called grade separated structures.
- ii) A grade separated structure which is provided for crossing of vehicles under the Project Highway is called as Vehicular Underpass (VUP).
- iii) A grade separated structure which is provided for crossing of vehicles over the Project Highway is called as Vehicular Overpass (VOP).
- iv) A structure provided below the Project Highway to cross the pedestrians is called Pedestrian Underpass (PUP).

- v) A structure provided below the Project Highway to cross the cattles is called Cattle Underpass (CUP).
- vi) A pedestrian/cattle underpass through which light vehicles of height upto 3 m can also pass is called Light Vehicular Underpass (LVUP)
- vii) Flyover is synonymous to VUP/VOP/LVUP/PUP/CUP.
- viii) A structure provided above the Project Highway to cross pedestrians is called Foot Over bridge.
- ix) A structure provided over the railway lines to carry the Project Highway is called Road Over Bridge (ROB).
- x) A structure provided below the railway lines to carry the Project Highway is called Road Under Bridge (RUB).
- xi) A Trumpet interchange is a grade separator structure provided at major T-junction facilitating uninterrupted flow of traffic in each direction.
- xii) A Cloverleaf is a grade separator structure provided at a major cross road junction facilitating uninterrupted flow of traffic in each direction

## SECTION – 2

### GEOMETRIC DESIGN AND GENERAL FEATURES

#### 2.1 General

- i) This section lays down the standards for geometric design and general features for four-lane divided carriageway.
- ii)
  - a) In built-up areas, 4-lane divided carriageway along with service roads with and without footpaths shall be provided as part of 4-laning of the Project Highway. Such stretches where the requirement of footpath is dispensed with and only 4-laning with or without service road is to be provided will be as indicated in Schedule 'B' of the Concession Agreement.
  - b) Where there is constraint of ROW width, the Authority may specify construction of a bypass. The alignment of the bypasses shall be as specified in Schedule 'B' and in conformity with the site earmarked in Schedule 'A' of the Concession Agreement.
- iii) The geometric design of the Project Highway shall conform to the standards set out in this section as a minimum.
- iv) As far as possible, uniformity of design standards shall be maintained throughout the length of the Project Highway. In case of any change, it shall be affected in a gradual manner.
- v) Where the existing road geometries are deficient with respect to minimum requirements and its improvements to the prescribed standards is not feasible due to any constraint in acquisition of additional land, such stretches shall be as specified in Schedule 'B' of the Concession Agreement.
- vi) Existing horizontal curves which are found deficient in radius, layout, transition lengths or super-elevation shall be corrected to the standards specified in this section.
- vii) Any deficiencies in the vertical profile in respect of grades, layout of vertical curves and sight distance shall be corrected to meet the minimum requirements specified in this section.

#### 2.2 Design Speed

**2.2.1** The design speeds given in **Table 2.1** shall be adopted for various terrain classifications (Terrain is classified by the general slope of the ground across the highway alignment).

**Table 2.1 Design Speed**

Nature of Terrain	Cross Slope of the Ground	Design Speed (km/h)	
		Ruling	Minimum
Plain and Rolling	Up to 25 percent	100	80
Mountainous and Steep	More than 25 percent	60	40

Short stretches (say less than 1 km) of varying terrain met with on the road stretch shall not be taken into consideration while deciding the terrain classification for a given section of Project Highway.

**2.2.2** In general, the ruling design speed shall be adopted for the various geometric design features of the road. Minimum design speed shall be adopted only where site conditions are restrictive and adequate land width is not available. Such stretches where design speed other than ruling speed is to be adopted shall be as indicated as deviation in Schedule 'D' of the Concession Agreement.

### **2.3 Right-of-Way**

A minimum Right of Way (ROW) of 60 m should be available for development of a 4-lane highway. The Authority would acquire the additional land required, if any. The land to be acquired shall be indicated in Schedule 'B' of the Concession Agreement. The consideration for planning, design and construction described in Para 1.13 shall apply.

### **2.4 Lane Width of Carriageway**

The standard lane width of project highway shall be 3.5 m.

### **2.5 Median**

**2.5.1** The median shall be either raised or depressed. The width of median is the distance between inside edges of carriageway. The type of median shall depend upon the availability of Right of Way. The minimum width of median, subject to availability of Right of Way, for various locations shall be as in **Table 2.2**.

**Table 2.2 Width of Median**

Type of Section	Minimum Width of Median (m)		
	Plain and Rolling terrain		Mountainous and Steep terrain
	Raised*	Depressed median	Raised*
Open country with isolated built-up area	5.0	7.0	2.50
Built up area	2.50	Not Applicable	2.50
Approach to grade separated structures	5.0	Not Applicable	2.50

\* Including Kerb shyness of 0.50 m on either side. In the existing 4-lane reaches also, the minimum kerb shyness of 0.5 m shall be maintained. This additional width for kerb shyness shall be catered by augmenting the carriageways toward the shoulder side.

The type and widths of median in various stretches of Project Highway shall be as indicated in Schedule 'B'.

**2.5.2** The median shall have suitably designed drainage system so that water does not stagnate in the median. All median drains shall be of Cement Concrete.

**2.5.3** In case of depressed median, a minimum 0.6 m width adjacent to carriageway in either direction shall be paved.

**2.5.4** As far as possible, the median shall be of uniform width in a particular section of the highway. However, where changes are unavoidable, a transition of 1 in 50 shall be provided.

**2.5.5** In the case of depressed median, metal beam type (thrie beam - one side) crash barriers or Wire rope barrier shall be provided on either side of the median subjected to the requirements laid out in Clause 9.7. Suitable shrubs as per Section 11 of this Manual shall also be provided.

However, in case the width of median is more than 9 m, no crash barrier is required to be provided in the median.

**2.5.6** The median in built up area shall be paved. In such locations, crash barriers and suitable antiglare measures such as plastic screens shall be provided at the center of median to reduce headlight glare from opposite traffic. The total height of screen including the height of the barrier shall be 1.5 m and spacing shall be such as to effectively cut the glare. In case of unpaved median suitable shrubs shall be planted as per Section 11 of this Manual.

## **2.6 Shoulders**

### **2.6.1** *Width of shoulders*

The shoulder width on the outer side (left side of carriageway) shall be as given in **Tables 2.3 and 2.4**.

**Table 2.3 Width of Shoulders in Plain and Rolling Terrain**

Type of Section	Width of Shoulder (m)		
	Paved	Earthen	Total
Open country with isolated built up area	1.5	2.0	3.5
Built up area	2.0	-	2.0
Approaches to grade separated structures	2.0	-	2.0
Approaches to bridges	1.5	2.0	3.5

**Table 2.4 Width of Shoulders in Mountainous and Steep Terrain (Hilly Area)**

Type of Section		Width of Shoulder (m)		
		Paved	Earthen	Total
Open country with isolated built up area	Hill Side	1.5 m	-	1.5 m
	Valley Side	1.5 m	1.0 m	2.5 m
Built up area and approaches to grade separated structures/bridges	Hill Side	0.25 m + 1.5 m (Raised)	-	1.75 m
	Valley Side	0.25 m + 1.5 m (Raised)	-	1.75 m

- Notes:** i) In case retaining wall with parapet is provided on valley side, the earthen shoulder may not be provided.
- ii) In mountainous and steep terrain the scope of work defined by the Authority may be two-lane carriageways on different alignments (contours). In that case, IRC:SP:73-2007 Manual of Specifications and Standards for Two-Laning of Highways shall apply to the two-lane carriageways on different alignments (contours).
- iii) Width of paved shoulder in approaches to grade separated structures as indicated in table above shall extend on either side of the structure in the entire length of retaining/RE walls. The retaining/RE walls on either side shall be abutting the paved shoulders and shall have crash barriers on top.

**2.6.2** Where embankment is more than 6 m high, kerb with channel shall be provided at the end of paved shoulder to channelize the drainage as an erosion control device in accordance with Section 6 of this Manual and earthen shoulder shall be raised upto the level of kerb.

## **2.7 Roadway Width**

**2.7.1** The width of roadway shall depend upon the width of carriageway, shoulders and the median.

**2.7.2** On horizontal curves with radius up to 300 m, width of pavement and roadway in each carriageway shall be increased as per **Table 2.5**.

**Table 2.5 Extra Width of Pavement and Roadway in Each Carriageway**

Radius of Curve	Extra Width
75-100 m	0.9 m
101-300 m	0.6 m

## 2.8 Crossfall

**2.8.1** The crossfall on straight sections of road carriageway, paved shoulders and paved portion of median shall be 2.5 percent for bituminous surface and 2.0 percent for cement concrete surface.

**2.8.2** The crossfall shall be unidirectional for either side carriageway sloping towards the shoulder in straight reaches and towards the lower edge on horizontal curves. The camber on the existing road shall be modified to unidirectional crossfall.

**2.8.3** The crossfall for earthen shoulders on straight portions shall be at least 0.5 percent steeper than the slope of the pavement and paved shoulder subject to a minimum of 3.0 percent. On super elevated sections, the earthen portion of the shoulder on the outer side of the curve would be provided with reverse crossfall of 0.5 percent so that the earth does not drain on the carriageway and the storm water drains out with minimum travel path.

## 2.9 Geometric Design

**2.9.1** Geometric design shall conform to IRC:73, except as otherwise indicated in this Manual.

**2.9.2** All horizontal curves shall consist of circular portion flanked by spiral transitions at both ends.

### 2.9.3 *Super elevation*

Super Elevation shall be limited to 7 percent, if radius of curve is less than desirable minimum radius. It shall be limited to 5 percent, if radius is more than desirable minimum.

### 2.9.4 *Radii of horizontal curves*

The desirable minimum and absolute minimum radii of horizontal curves for various classes of terrain are given in **Table 2.6**

**Table 2.6 Radii of Horizontal Curves**

Nature of Terrain	Desirable Minimum Radius	Absolute Minimum Radius
Plain and Rolling	400 m	250 m
Mountainous and Steep	150 m	75 m

The radius of horizontal curves for various terrain conditions shall not be less than the desirable minimum values given in **Table 2.6** except for Sections as indicated in Schedule 'B'. For such Sections, the radius shall not be less than the absolute minimum.

### 2.9.5 *Sight distance*

The safe stopping sight distance and desirable minimum sight distance for divided carriageway for various design speeds are given in **Table 2.7**. The desirable values of sight distance shall be adopted throughout unless specified in Schedule 'B'. A minimum of safe stopping sight distance shall be available throughout.

**Table 2.7 Safe Sight Distance**

Design Speed (km/h)	Safe Stopping Sight Distance (m)	Desirable Minimum Sight Distance (m)
100	180	360
80	130	260
60	90	180
40	45	90

### 2.9.6 Vertical alignment

2.9.6.1 The vertical alignment should provide for a smooth longitudinal profile. Grade changes shall not be too frequent as to cause kinks and visual discontinuities in the profile. In this regard, directions given in IRC:73 should be kept in view.

#### 2.9.6.2 Gradients

The ruling and limiting gradients are given in **Table 2.8**.

Ruling Gradients shall be adopted as far as possible. Limiting Gradient shall be adopted in difficult situations and for short lengths.

**Table 2.8 Gradients**

Nature of Terrain	Ruling Gradient	Limiting Gradient
Plain and Rolling	2.5%	3.3%
Mountainous	5.0%	6.0%
Steep	6.0%	7.0%

2.9.6.3 Long sweeping vertical curves shall be provided at all grade changes. These shall be designed as square parabolas.

2.9.6.4 Design of vertical curves and its coordination with horizontal curves, shall be in accordance with IRC:SP:23.

## 2.10 Lateral and Vertical Clearance at Underpasses

Wherever the Project Highway is proposed to be taken above/over a cross road minimum clearances at underpasses shall be as follows:

### 2.10.1 Lateral clearance

- i) Full roadway width of the cross road shall be carried through the vehicular underpass. The lateral clearance shall not be less than 12 m (7 m carriageway + 2 x 2.5 m shoulder width on either side) or as indicated in Schedule 'B'.
- ii) For Light Vehicular Underpass the lateral clearance shall not be less than 10.5 m including 1.5 m wide raised footpath on either side.
- iii) For pedestrian and Cattle underpasses the lateral clearance shall not be less than 7 m.



- iv) Guard rails/crash barriers shall be provided for protection of vehicles from colliding with the abutments and piers and the deck of the structures.

### 2.10.2 Vertical clearance

Vertical clearance at underpasses shall not be less than the values given below:

i) Vehicular Underpass	5.5 m
ii) Light Vehicular Underpass	3.5 m
iii) Pedestrian and Cattle Underpass	3.0 m (to be increased to 4.5 m, in case certain categories of animals such as elephant/camel are expected to cross the Project Highway frequently. This will be as specified in Schedule 'B')

Wherever existing slab/box culverts and bridges allow a vertical clearance of more than 2 m, these can be used in dry season for pedestrian and cattle crossing by providing necessary flooring. However, these will not be a substitute for normal requirements of pedestrian and cattle crossings as per Para 2.13. 4.

## 2.11 Lateral and Vertical Clearance at Overpasses

Wherever any structure is provided over the Project Highway; the minimum clearances at overpasses shall be as follows:

### 2.11.1 Lateral clearance

Full roadway width shall be carried through the overpass structure unless otherwise specified in Schedule 'B'. Provision shall also be made for future widening of the Project Highway to 6-lane with service roads. The abutments and piers shall be provided with suitable protection against collision of vehicles. Crash barriers shall be provided on abutment side and on sides of piers for this purpose. The ends of crash barriers shall be turned away from the line of approaching traffic. The span arrangement for the overpass structure shall be as specified in Schedule 'B'.

### 2.11.2 Vertical clearance

A minimum 5.5 m vertical clearance shall be provided at all points of the carriageway of the Project Highway.

## 2.12 Access to Project Highway

### 2.12.1 Access

Access to the Project Highway shall be partially controlled. In general, access to the Project Highway shall be provided at the following locations:

- i) Intersection with National Highways
- ii) Intersection with State Highways
- iii) Intersection with Major District Roads

- iv) Intersection with Village Road and Other District Roads, subject to a minimum distance of 3 km from the nearest intersection. The locations of intersections shall be specified in Schedule 'B'.

### 2.12.2 *Service road*

2.12.2.1 In open country with isolated built up area, the service road shall have 7 m wide carriageway and 1.5 m wide earthen shoulder on either side. In built up area, the service road shall have 7.5 m wide carriageway (including kerb shyness of 0.25 m on either side) with raised footpath/separator on either side as given in Para 2.15 and as shown in **Fig. 2.6**. Any deviations to the above provisions shall be specified in Schedule 'D' of the Concession Agreement. Wherever required provision for Parking Bays of length 20 m and width 3 m may be made along the service road and the same shall be specified in Schedule 'B' of the Concession Agreement.

2.12.2.2 For the stretches where total length of a bridge is less than 60 m and the service road is required to be provided on both sides of the stream, then the service road shall continue across the stream and suitably designed 2-lane bridge structure shall be provided. In cases involving bridges of 60 m length or more, separate bridge structures may not be provided and service road shall be merged with the Project Highway at 50 m distance before the bridge structure. Any deviation to this shall be specified in Schedule 'D'.

2.12.2.3 Wherever service roads are provided, provision shall be made for proper entry and exit ramps between the main highway and the service roads through properly designed acceleration and deceleration length, duly keeping in view future widening of main highway to six-lanes. The layout for entry/exit at service road shall be as per **Figs. 2.1A** and **2.1B**. Any deviations to these layouts due to site constraints shall be specified in Schedule 'D' of the Concession Agreement.

### 2.12.2.4 *Design speed*

A minimum design speed of 40 km/h shall be adopted for service roads.

2.12.3 *Acceleration and deceleration lanes*: The following requirements shall apply:

- i) Length: Designed for a speed differential of 60 km/h
- ii) Width: 5.5 m (minimum)
- iii) Taper at merge: 1 in 15 beyond design length

2.12.4 The acceleration and deceleration lanes and transition length will be considered as incidental to the project and shall not be counted towards service road length.

## 2.13 **Grade Separated Structures**

2.13.1 The type and location of various grade separated structures (VUP, LVUP, PUP/CUP, VOP) shall be as specified in Schedule 'B' of the Concession Agreement. In case the lateral/vertical clearance and total length of viaduct to be provided is different from the minimum specified in this Section, the same shall also be specified in Schedule 'B'. The entry/exit arrangement at grade-separated structures with slip roads shall be as shown in **Figs. 2.1C** to **2.1F**. Depending on the traffic volume and speed and other factors, the layout to be adopted for each case as per **Figs. 2.1C** to **2.1F** shall be specified in Schedule 'B'.

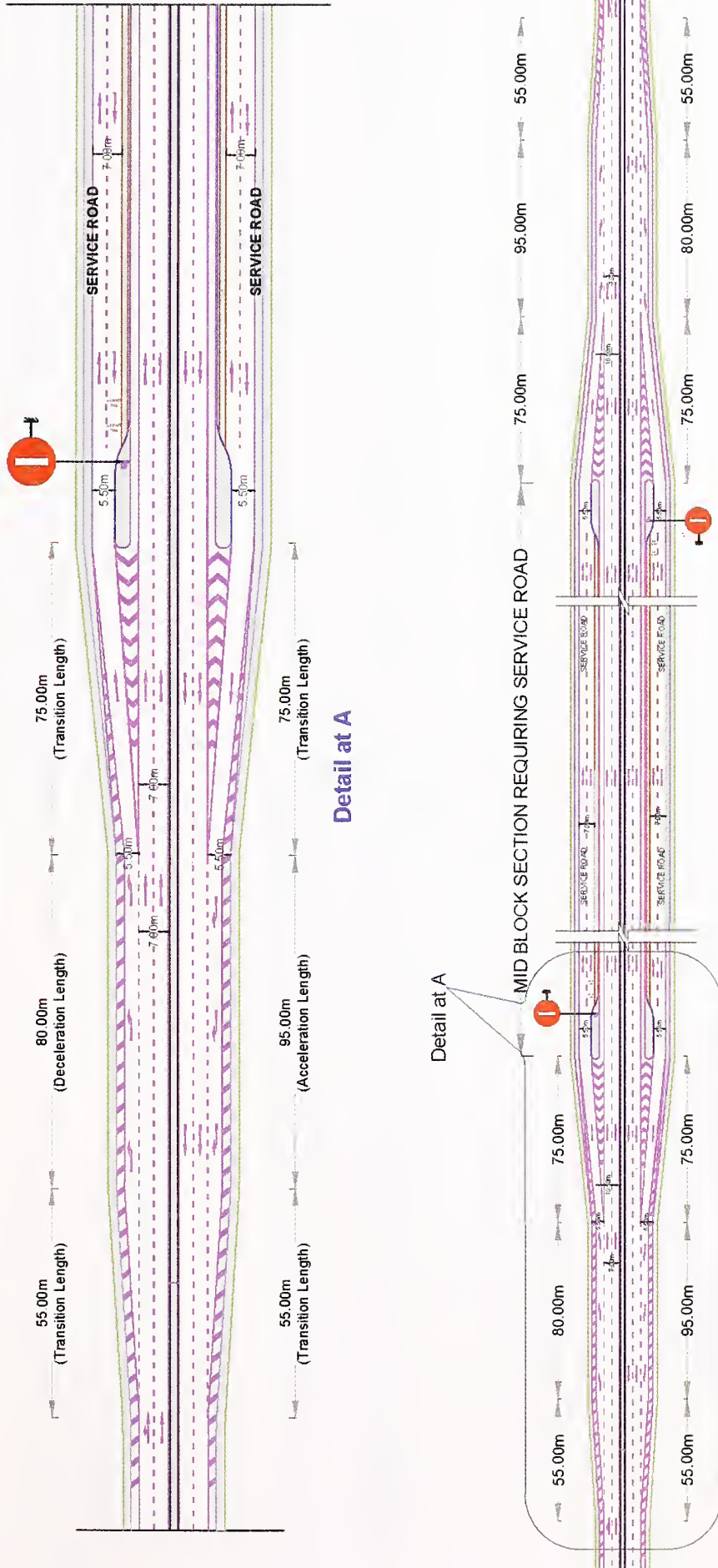

Fig 2.1A : Entry/Exit Arrangement with Service Road

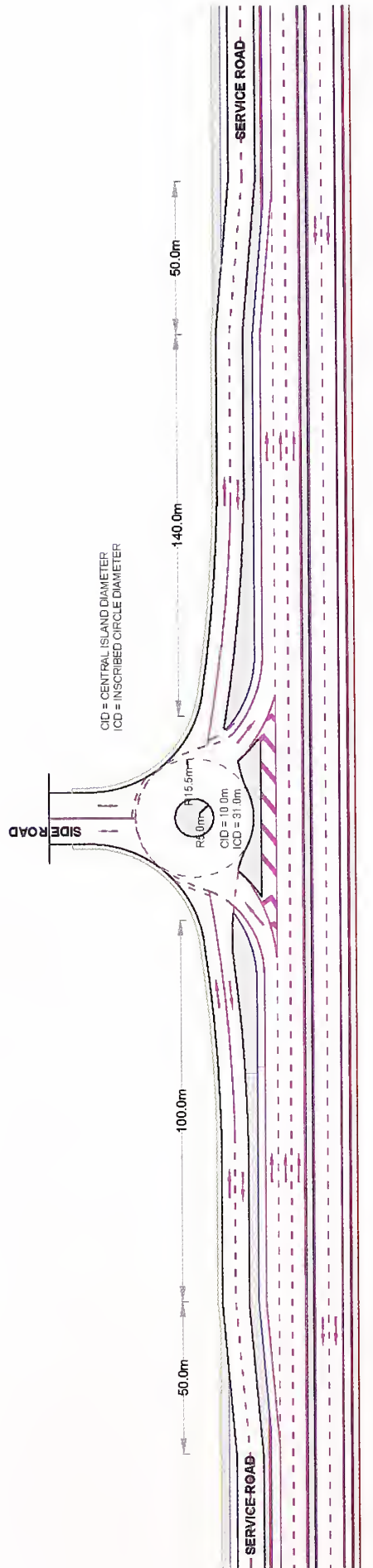

Fig 2.1B : Entry/Exit Arrangement with a Side Road  
(Service Road Continuing)

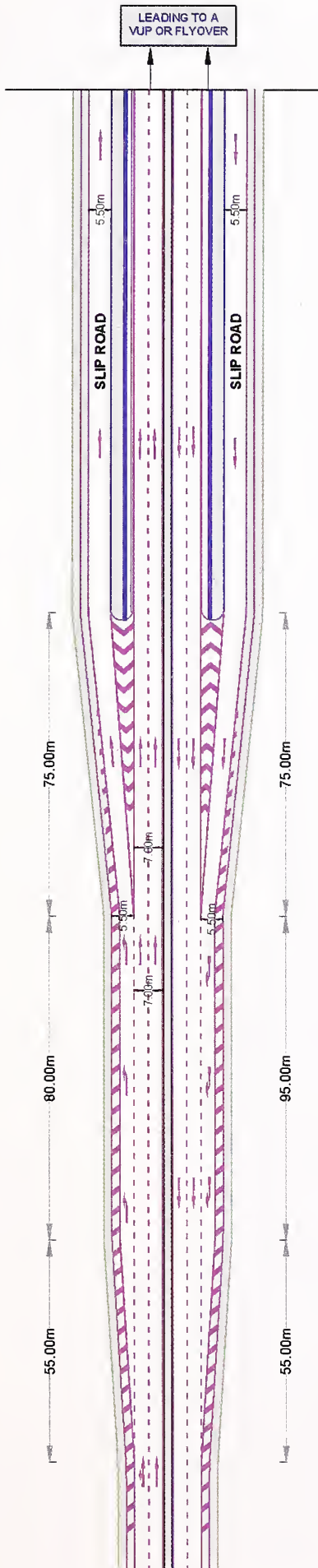

Fig 2.1C : Entry/Exit Arrangement at Grade-Separated Structures with Slip Road  
(No Service Road)

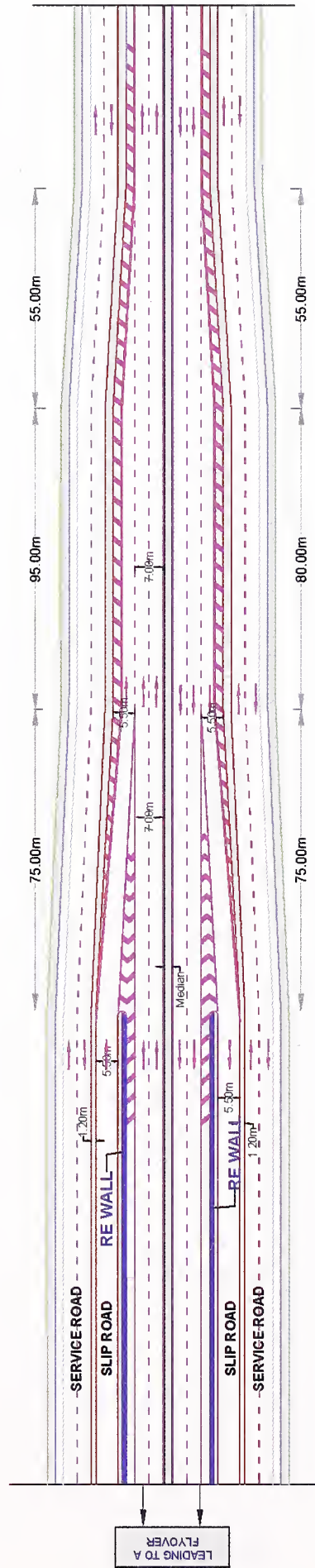

Fig 2.1D : Entry/Exit Arrangement at Grade-Separated Structures with Slip Road  
(Service Road & Slip Road Segregated)



Fig 2.1E : Entry/Exit Arrangement at Grade-Separated Structures with Service Road cum Slip Road  
(Speed Reduction by Deflection)

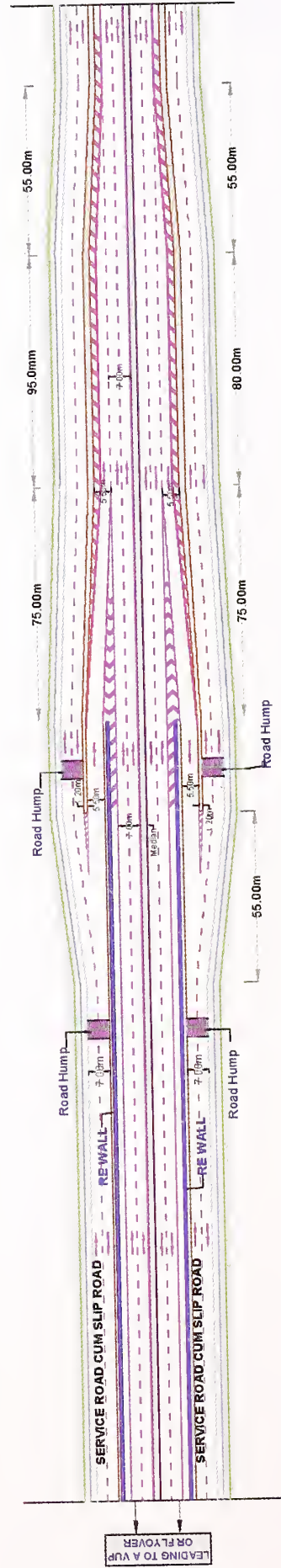

Fig 2.1F : Entry/Exit Arrangement at Grade-Separated Structures with Service Road cum Slip Road  
(Speed Reduction by Road Hump)

### 2.13.2 *Vehicular underpass/overpass*

The vehicular under/overpass structures shall be provided at the intersection of the Project Highway with all the National Highways and State Highways. Such under/over passes shall also be provided across other categories of roads as per site requirements for crossing of traffic. The structure may be either an underpass or an overpass depending upon the nature of terrain, vertical profile of road and availability of adequate right of way etc. Decision whether the cross road or the Project Highway will be carried at the existing level will be taken at the time of preparing the feasibility report and would be based on considerations of drainage, land acquisition, provision of ramps for the grade separated facility, height of embankment and project economy etc.

### 2.13.3 *Light Vehicle Underpass (LVUP)*

The location of LVUPs shall be specified in Schedule 'B'.

### 2.13.4 *Cattle/Pedestrian Underpass (CUP/PUP) and Foot Over Bridge*

These shall be provided as specified in Schedule 'B' of the Concession Agreement.

- i) A PUP/CUP/Foot Over Bridge may not be necessary within a distance of 2 km from Vehicular underpasses/overpasses and Light Vehicular Underpasses.
- ii) The pedestrian crossings (PUP/FOB) shall have provision for movement of physically challenged persons.
- iii) Underpasses shall be preferred to Foot Over Bridges.
- iv) Pedestrian underpass/Foot Over Bridge shall also be provided within a distance of 200 m from a school or hospital or factory/industrial area.
- v) The Bus Bays along with the Bus Shelters shall be provided at the identified pedestrian Underpass/Foot Over Bridge locations as specified in Para 12.5 of this Manual. Such locations shall be specified in Schedule 'B'.

A typical cross-section for cattle/pedestrian underpass is given in **Fig. 7.8**. The central portion open to sky shall be so covered as to allow air and light, but not rain water.

**2.13.5** Road Over Bridges (ROBs)/Road Under Bridges (RUBs) for crossing the Railway tracks shall be provided as per Section 7 of this Manual.

### 2.13.6 *Tunnels*

Standards for Tunnels shall be as given in Section 14 of this Manual.

## 2.14 **Median Openings**

**2.14.1** In open country, median openings shall not be spaced closer than 2 km. Additional controlled openings shall also be provided for inspection and diversion of traffic during repair and rehabilitation. In built up area, median opening shall be provided as per site requirement and the spacing between two medians opening in built up area shall not be less than 500 m. All such locations shall be mentioned in Schedule 'B' of Concession Agreement.

**2.14.2** Median opening shall not be provided in front of the service road entry. The distance between the service road entry and the median opening shall be at least equal to the sum of length of acceleration lane, weaving length, and deceleration length. This distance shall however be not less than 150 m. Location of opening shall be so decided as to minimize contraflow.

**2.14.3** All median openings shall be provided with additional 3.5 m wide shelter lane by the side of median in both directions for waiting of vehicles to take U-turn. Wherever required, horizontal geometries of the road shall be suitably adjusted.

**2.14.4** *Length of median opening shall be 18 to 20 m only.*

## **2.15 Separator, Footpath and Drain in Built-up Areas**

**2.15.1** Raised Footpath of minimum 1.5 m width with kerb on either side (200 mm above road surface), drain pipes across at minimum 10 m intervals and finished with CC paving blocks along with Metal Beam Barrier (Thrie Beam - one side) or pedestrian guard rail as given in Para 9.10 of this Manual at the edge of footpath (towards carriageway side) shall be provided between service road and carriageway as shown in **Fig. 2.6**.

**2.15.2** Drain-cum-footpath shall be provided at the edge of the service road (ROW side).

**2.15.3** The raised footpath shall be depressed at suitable intervals to provide for convenient use of physically challenged persons.

## **2.16 Utility Corridor**

Two metre wide strip of land at the extreme edge of ROW shall be kept for accommodating utilities, both over as well as underground. Provisions contained in IRC:98 shall be followed to accommodate utility services in built-up areas of Project Highway. Utility ducts in the form of 600 mm diameter NP-4 Pipe across the Project Highway along with inspection box/chamber at a spacing of 1 km shall be provided for crossing of underground utilities in built up areas.

## **2.17 Typical Cross-sections**

Typical cross-sections of Project Highway are given in **Figs. 2.2 to 2.10** for various locations as below:

**Fig. 2.2** shows typical cross-section Type-A1 for 4-lane divided highway in open country with isolated built-up area in plain/rolling terrain, without service roads and with depressed median.

**Fig. 2.3** shows typical cross-section Type-A2 for 4-lane divided highway in open country in plain/rolling terrain with service roads on both sides and with depressed median.

**Fig. 2.4** shows typical cross-section Type-A3 for 4-lane divided highway in open country with isolated built-up area in plain/rolling terrain, without service roads and with raised median.

**Fig. 2.5** shows typical cross-section Type-A4 for 4-lane divided highway in open country in plain/rolling terrain with service roads on both sides and with raised median.



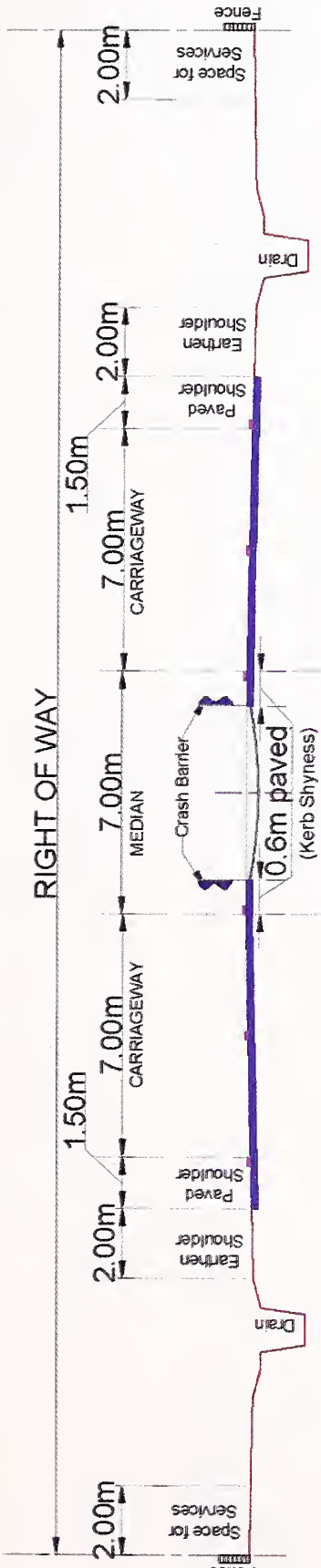

TYPICAL CROSS SECTION TYPE A-1  
(Open Country Plain/Rolling Terrain)

- Pavement Marking

Fig 2.2 : 4 Lane Divided Highway without Service Roads and with Depressed Median

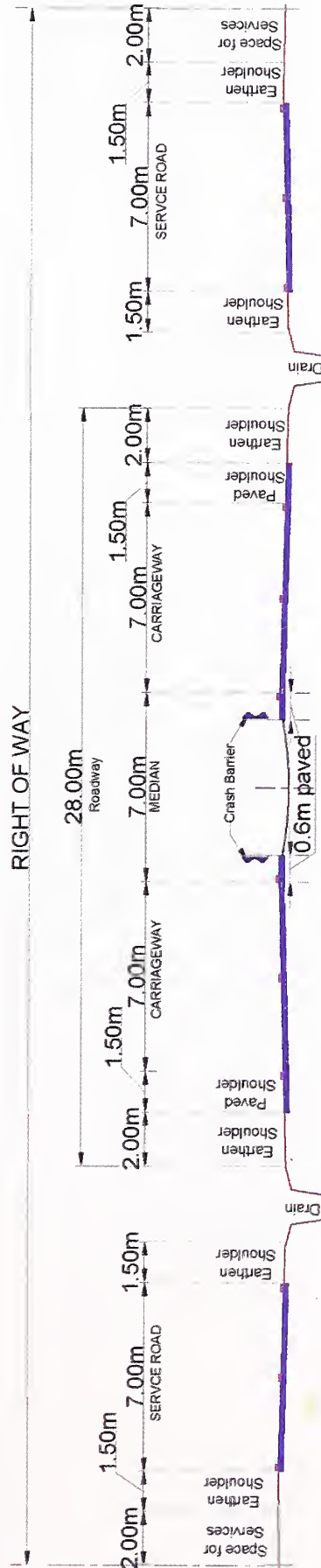

TYPICAL CROSS SECTION TYPE A-2  
(Open Country Plain/Rolling Terrain)

- Pavement Marking

Fig 2.3 : 4 Lane Divided Highway with Service Roads and with Depressed Median

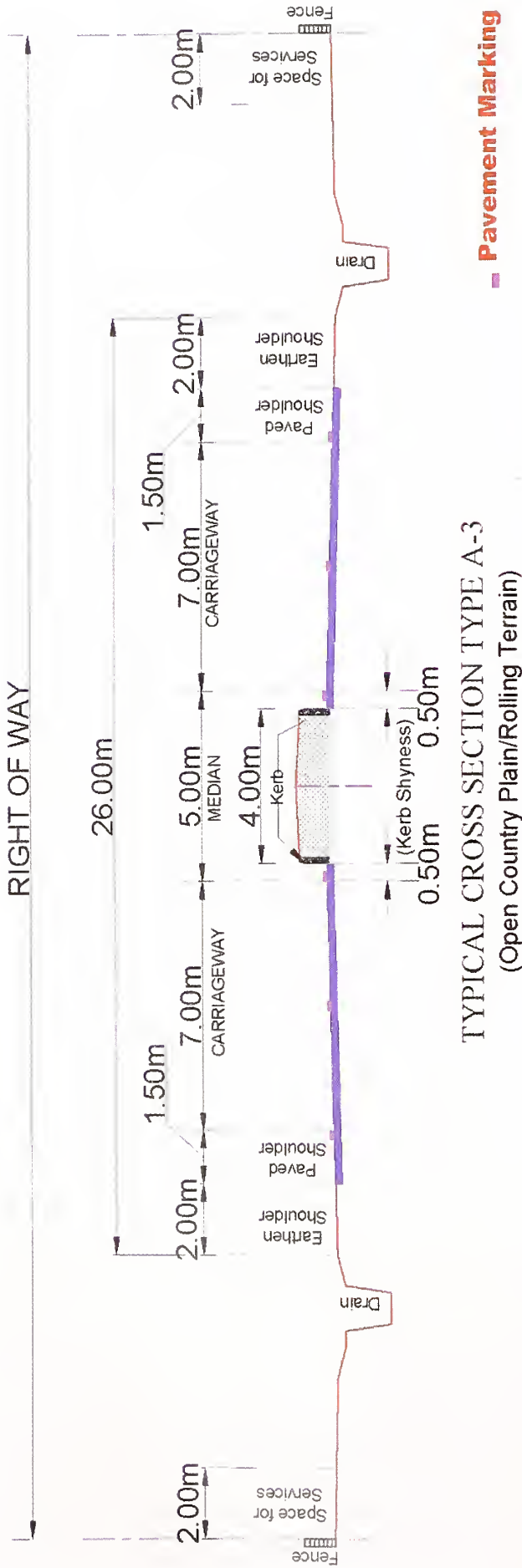

Fig 2.4 : 4 Lane Divided Highway without Service Roads and with Raised Median

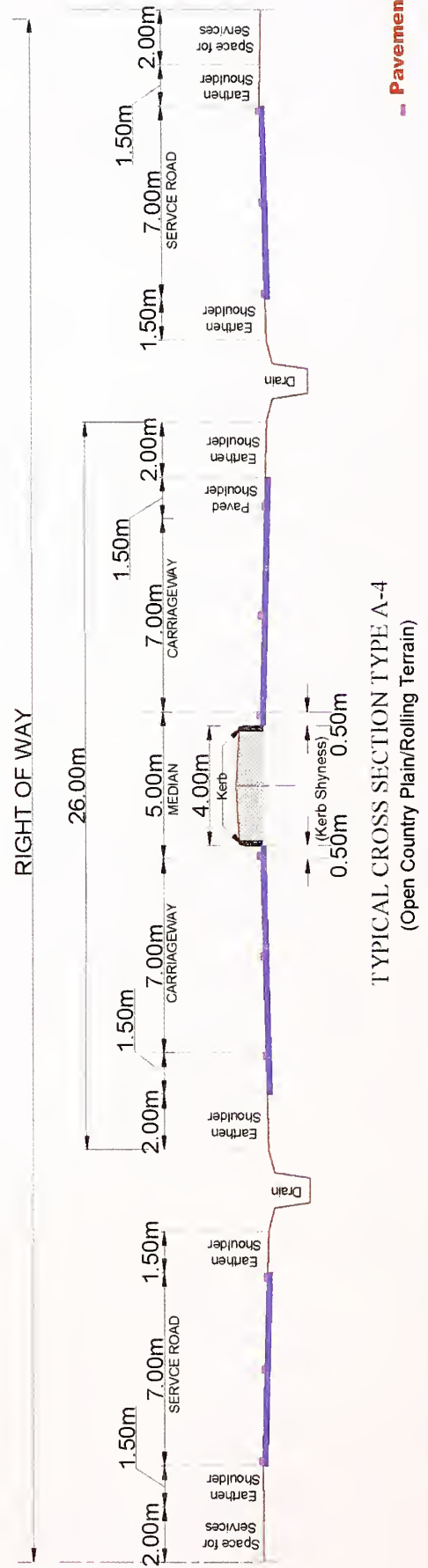

Fig 2.5 : 4 Lane Divided Highway with Service Roads and with Raised Median

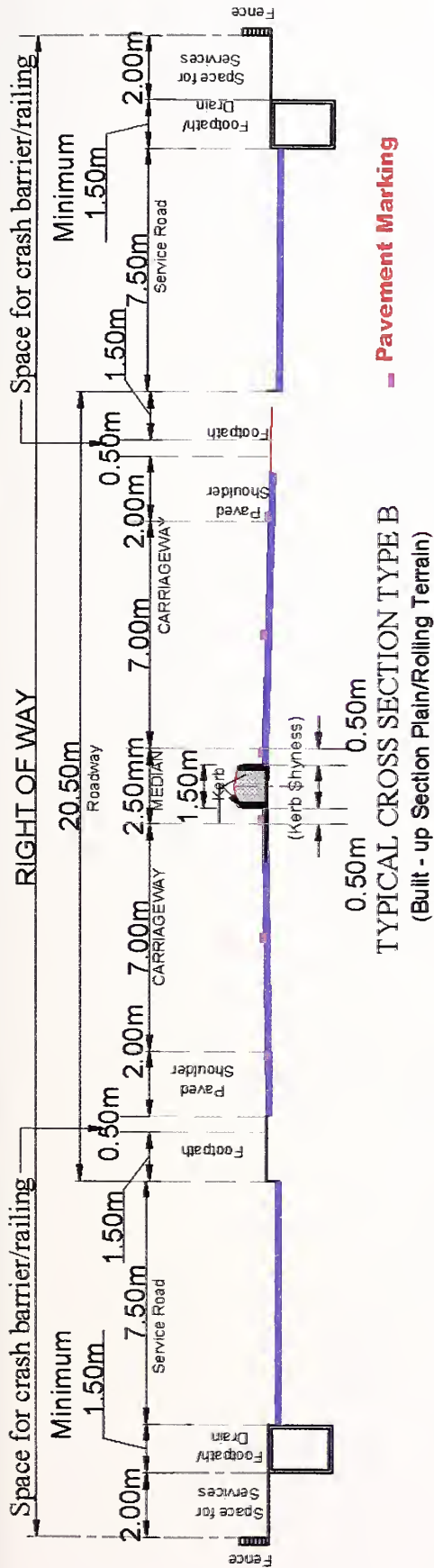
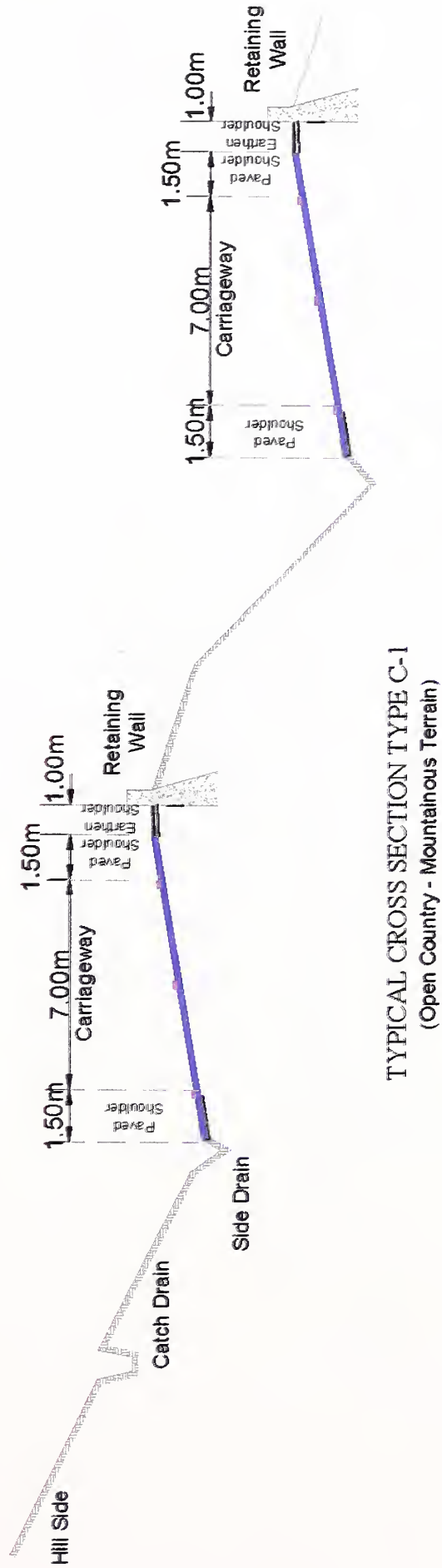
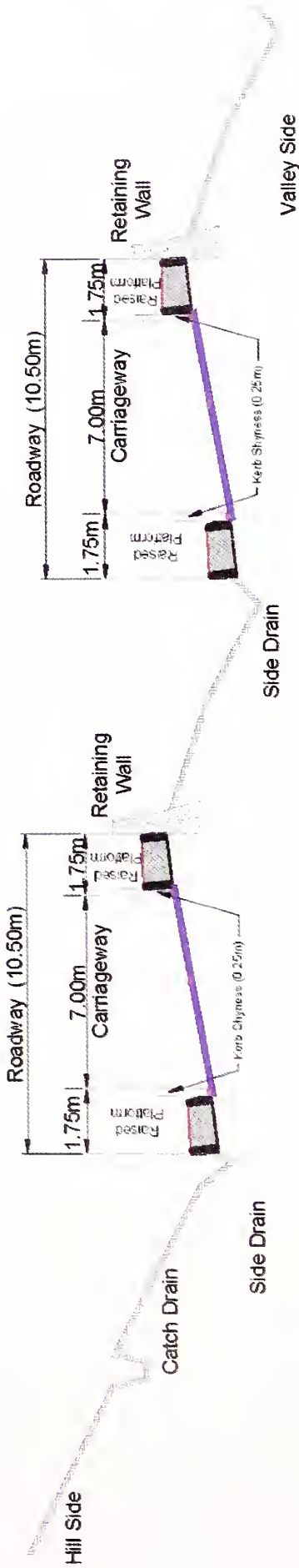

Fig 2.6 : 4 Lane Divided Highway with Service Roads and with Raised Median



- Pavement Marking

Fig 2.7 : 4 Lane Divided Highway on Different Contours



TYPICAL CROSS SECTION TYPE C-2  
(Built - up Section - Mountainous Terrain)

Fig 2.8 : 4 Lane Divided Highway on Different Contours

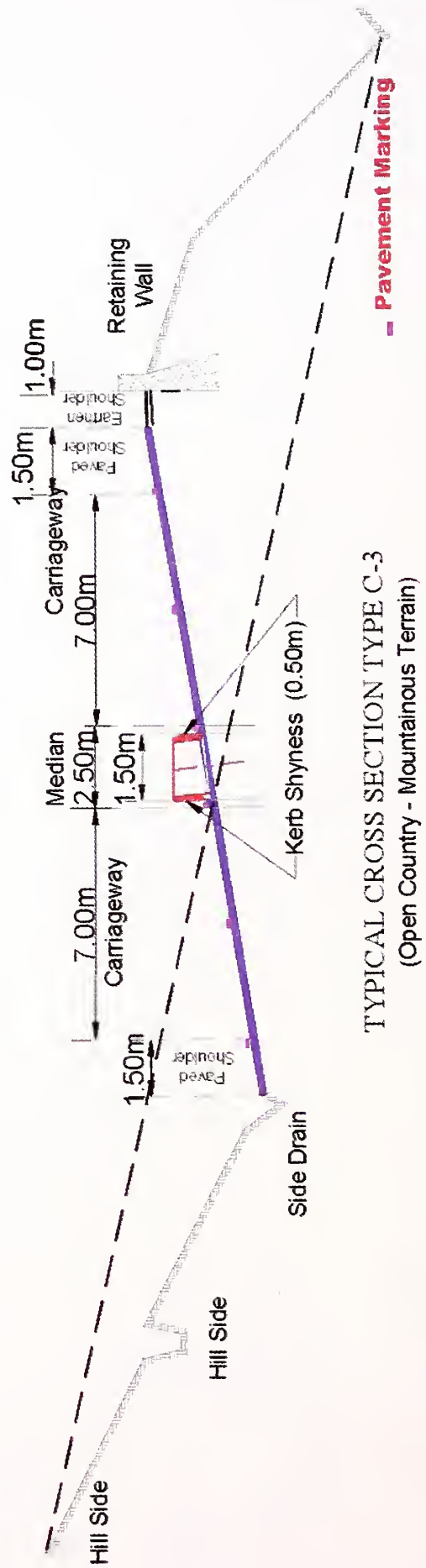

TYPICAL CROSS SECTION TYPE C-3  
(Open Country - Mountainous Terrain)

Fig 2.9 : 4 Lane Divided Highway at same level with Raised Median

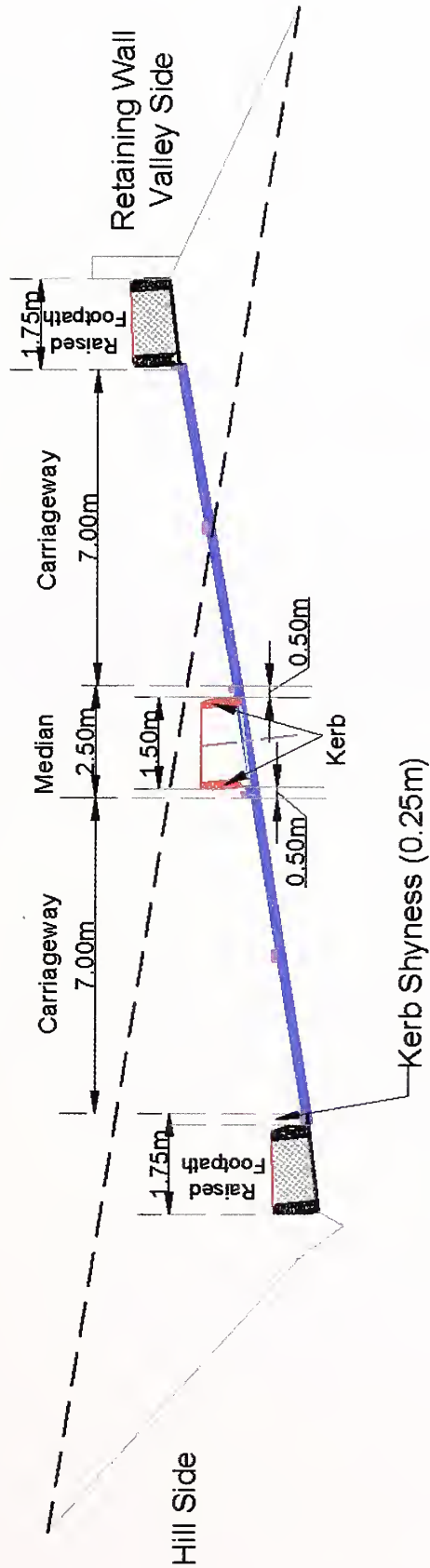

- Pavement Marking

**TYPICAL CROSS SECTION TYPE C-4**  
(Built - up Section- Mountainous Terrain)

Fig 2.10 : 4 Lane Divided Highway at same level with Raised Median

**Fig. 2.6** shows typical cross-section Type-B for 4-lane divided highway in built-up section in plain and rolling terrain with service roads on both sides and with raised median.

**Fig. 2.7** shows typical cross-section Type-C1 for 4-lane divided highway on different contours in open country with isolated built-up area in mountainous terrain.

**Fig. 2.8** shows typical cross-section Type-C2 for 4-lane divided highway on different contours in built-up section in mountainous terrain.

**Fig. 2.9** shows typical cross-section Type-C3 for 4-lane divided highway at same level in open country with isolated built-up area in mountainous terrain.

**Fig. 2.10** shows typical cross-section Type-C4 for 4-lane divided highway at same level in built-up section in mountainous terrain.

### 2.18 Capacity of Four-Lane Highway

For the purpose of augmentation of the facilities and up-gradation of the Project Highway, the design service volume for different terrain conditions and level of service shall be as specified in **Table 2.9**.

**Table 2.9 Design Service Volume for Four-Lane Highways in PCU Per Day**

Terrain	Design Service Volume in PCU Per Day	
	Level of Service 'B'	Level of Service 'C'
Plain and Rolling	40,000	60,000
Mountainous and Steep	20,000	30,000

**Note:** The definition of PCU here is as per IRC Codes and Guidelines and not as per the definition given in MCA

### 2.19 Warrants for Six-Laning

Unless otherwise specified in the Concession Agreement, the Project Highway shall be widened to 6-lane when total traffic including the traffic on service roads, if any, reaches the design service volume corresponding to Level of Services 'C' for 4-lane highway specified in **Table 2.9**. The augmentation to six laning shall be as per IRC:SP:87.

## SECTION – 3

### INTERSECTIONS AND GRADE SEPARATORS

#### 3.1 Introduction

3.1.1 The intersections to be provided shall be one of the following types:

- i) At-grade Intersections
- ii) Grade separated Intersections without ramps
- iii) Interchanges

3.1.2 The existing intersections, which are deficient with respect to the minimum requirements, shall be improved to the prescribed standards. Additional land, if any, required for improving the existing intersections shall be provided by the Authority.

The types and locations of new Intersections, Interchanges and Grade-separated Intersections without ramps shall be based on requirements stipulated in IRC:SP:41, IRC:5, IRC:92, MORTH Specifications for Road and Bridge Works. These shall be specified in Schedule 'B' of the Concession Agreement.

#### 3.2 At-Grade Intersections

3.2.1 The type of intersections to be adopted shall be decided on the basis of parameters like number of intersecting legs, traffic volume/speed, type of traffic control etc. Properly designed intersections shall be provided at all at-grade crossings. Rotary shall not be provided on the Project highway.

- 3.2.2
- i) The intersections shall be designed having regard to flow, speed, composition, distribution and future growth of traffic. Design shall be specific to each site with due regard to physical conditions of the site available. The design of different elements of intersection shall be done as per IRC:SP:41 "Guidelines on Design of At-grade Intersections in Rural and Urban Areas" including other criteria given in this Manual. MORTH - Type Designs for Intersection on National Highways may also be referred to, wherever required to develop suitable layout and design of At-grade Intersections.
  - ii) At multi leg intersections, the points of conflict should be studied carefully and possibilities of realigning one or more of the intersecting legs and combining some movements to reduce the conflicting movements shall be examined. The object shall be to simplify the design and appropriate control devices added to ensure more efficient and safe operation.
  - iii) The channelising islands shall start from the edge of the paved shoulder. This principle shall also apply in case of MORTH - Type Designs for Intersections on National Highways.

\*\* 55.0m is the minimum storage length to be provided based on deceleration length, but shall be increased to cater peak hour turning traffic volume of 10th year.

++ The angle of intersection between project highway and side road shall ideally be 90° and shall never be less than 70°

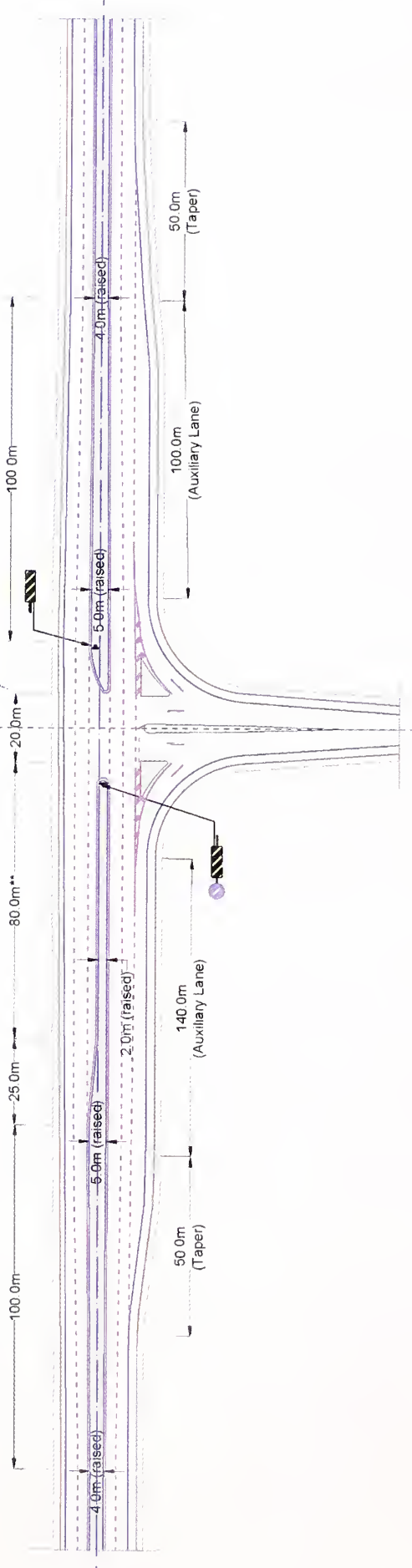
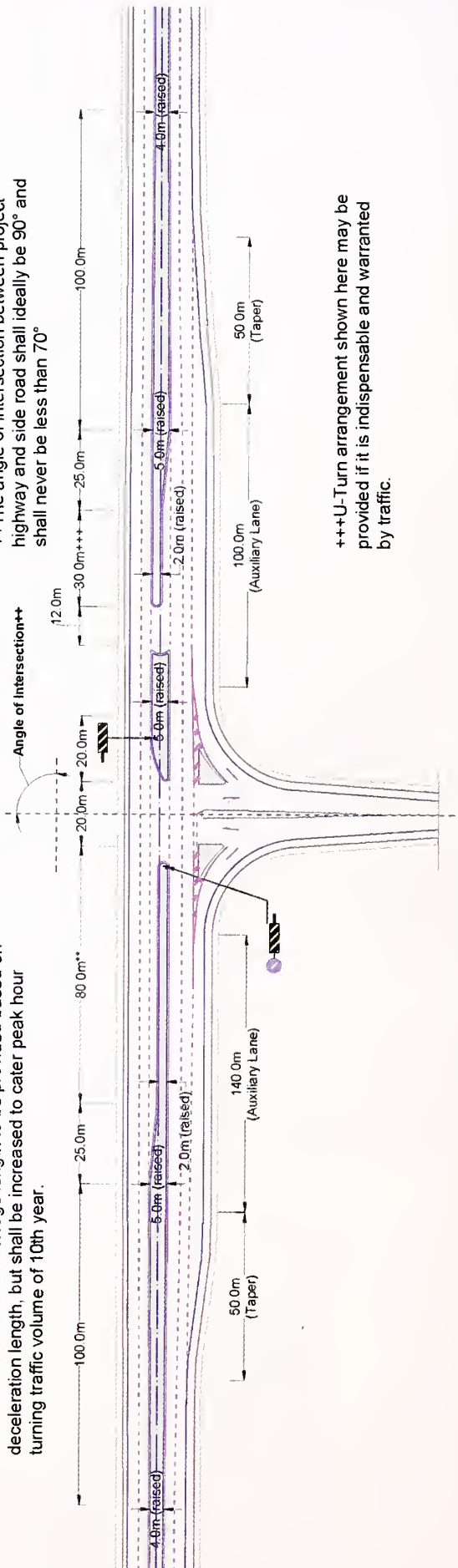

Fig 3.1 : Layout for T-Intersection  
(With Right Turn Protected Arrangement)

\*\* 55.0m is the minimum storage length to be provided based on deceleration length, but shall be increased to cater peak hour turning traffic volume of 10th year.

++ The angle of intersection between project highway and side road shall ideally be 90° and shall never be less than 70°



+++ U-Turn arrangement shown here may be provided if it is indispensable and warranted by traffic.

Fig 3.2 : Layout for T-Intersection with U-Turn Facility  
(At locations having substantial U-Turn Traffic Volume)



\*\* 55.0m is the minimum storage length to be provided based on deceleration length, but shall be increased to cater peak hour turning traffic volume of 10th year.

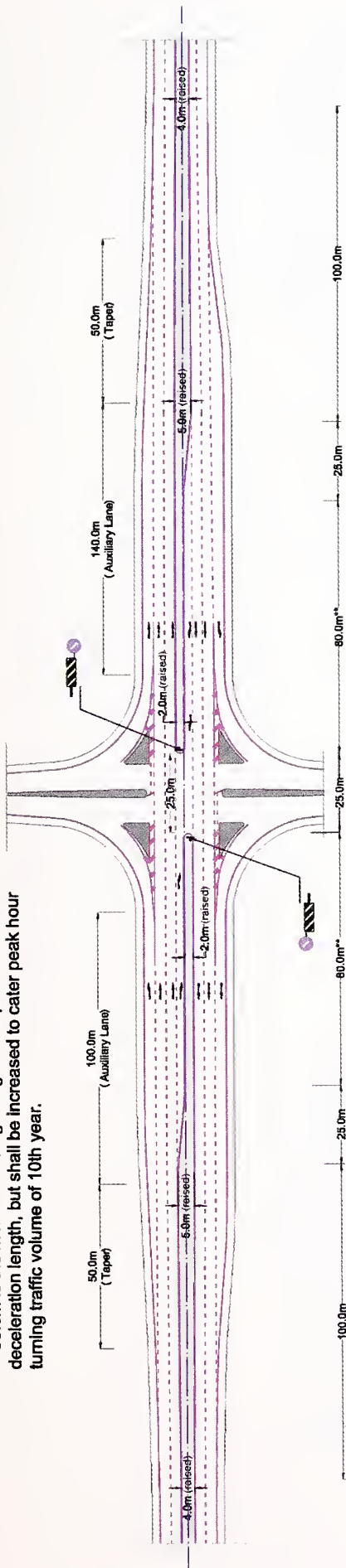
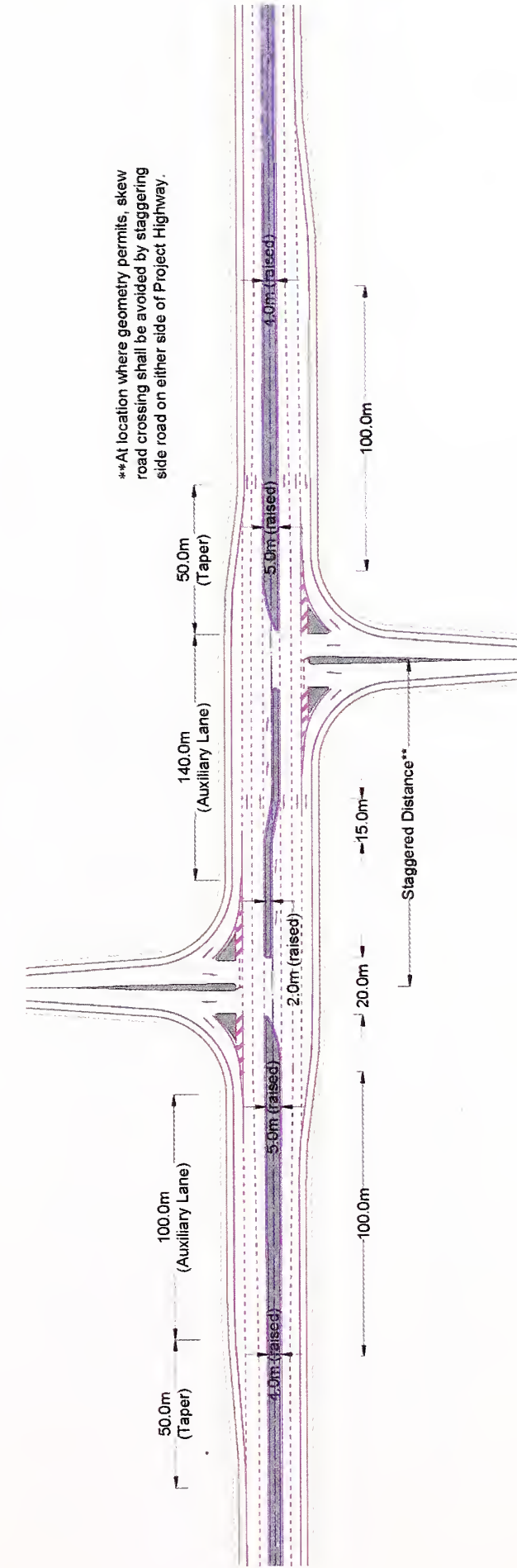

Fig 3.3 : Layout for Cross Road Intersection (With Right Turn Protected Arrangement)



\*\*At location where geometry permits, skew road crossing shall be avoided by staggering side road on either side of Project Highway.

Fig 3.4 : Layout for Staggered Intersection (With Right Turn Protected Arrangement)

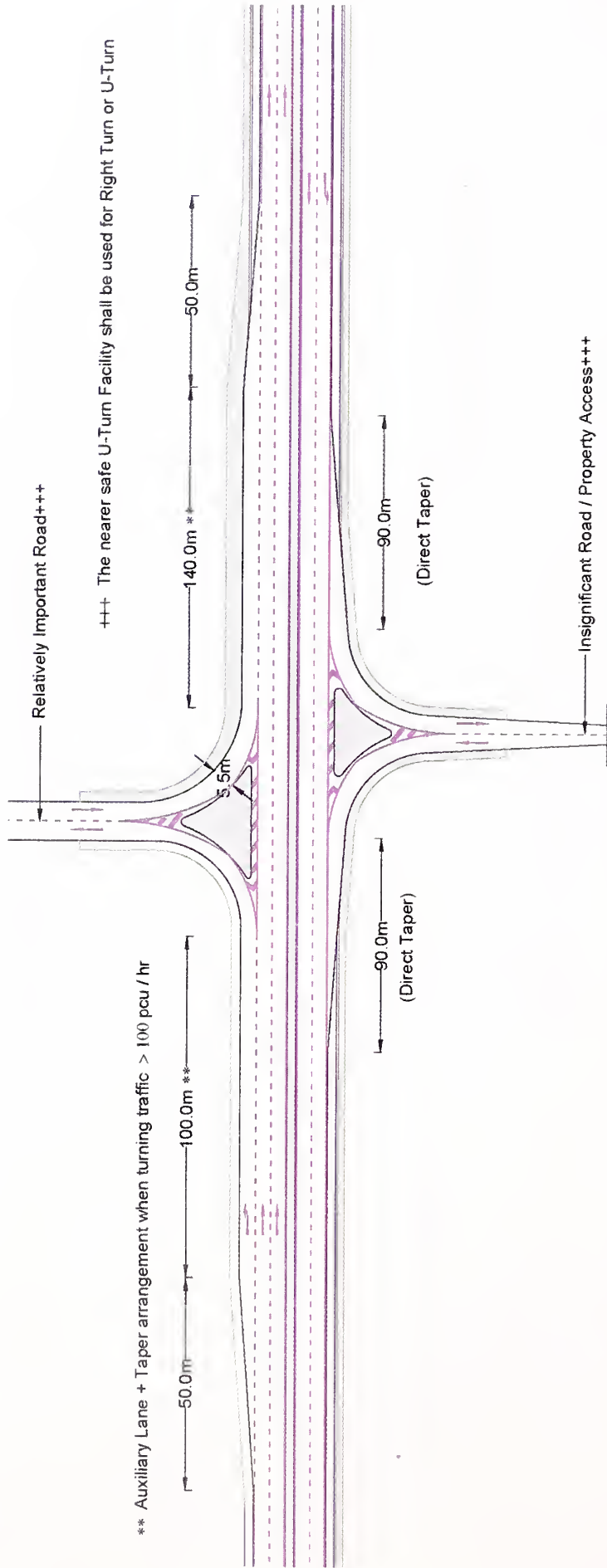

Fig 3.5 : Left-in/Left out Arrangement

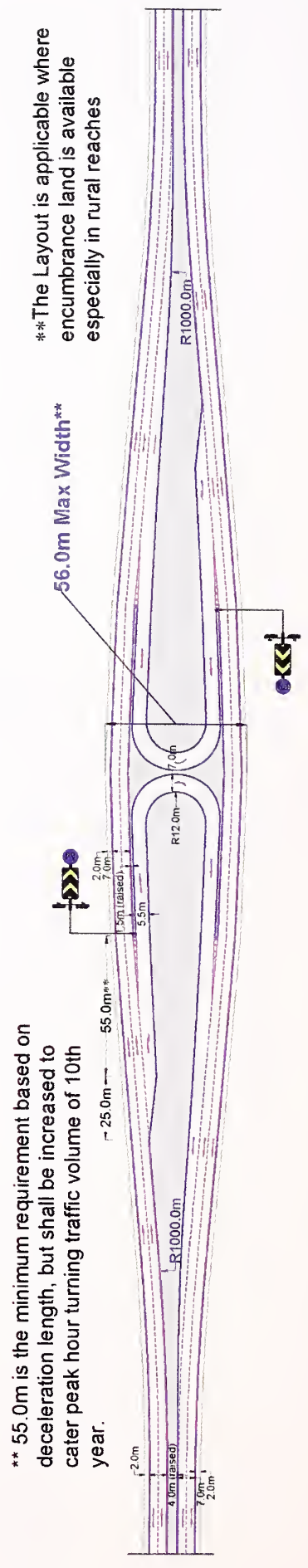

Fig 3.6 : Self-Regulated U-Turn Facility

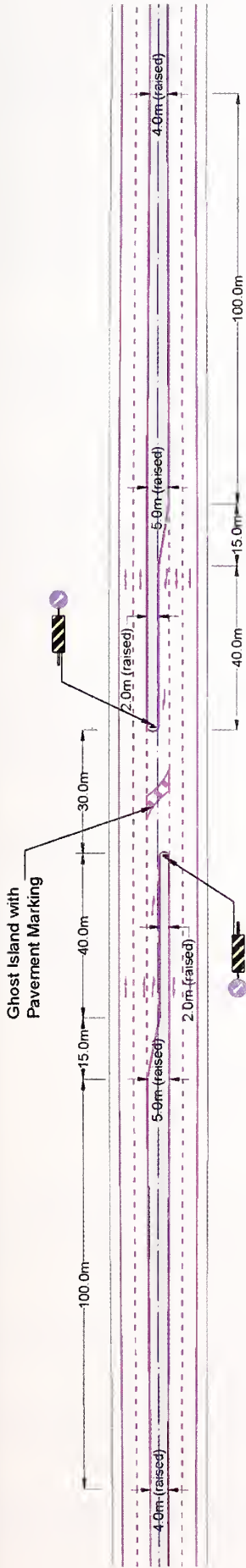

Fig 3.7 : Layout for U-turn

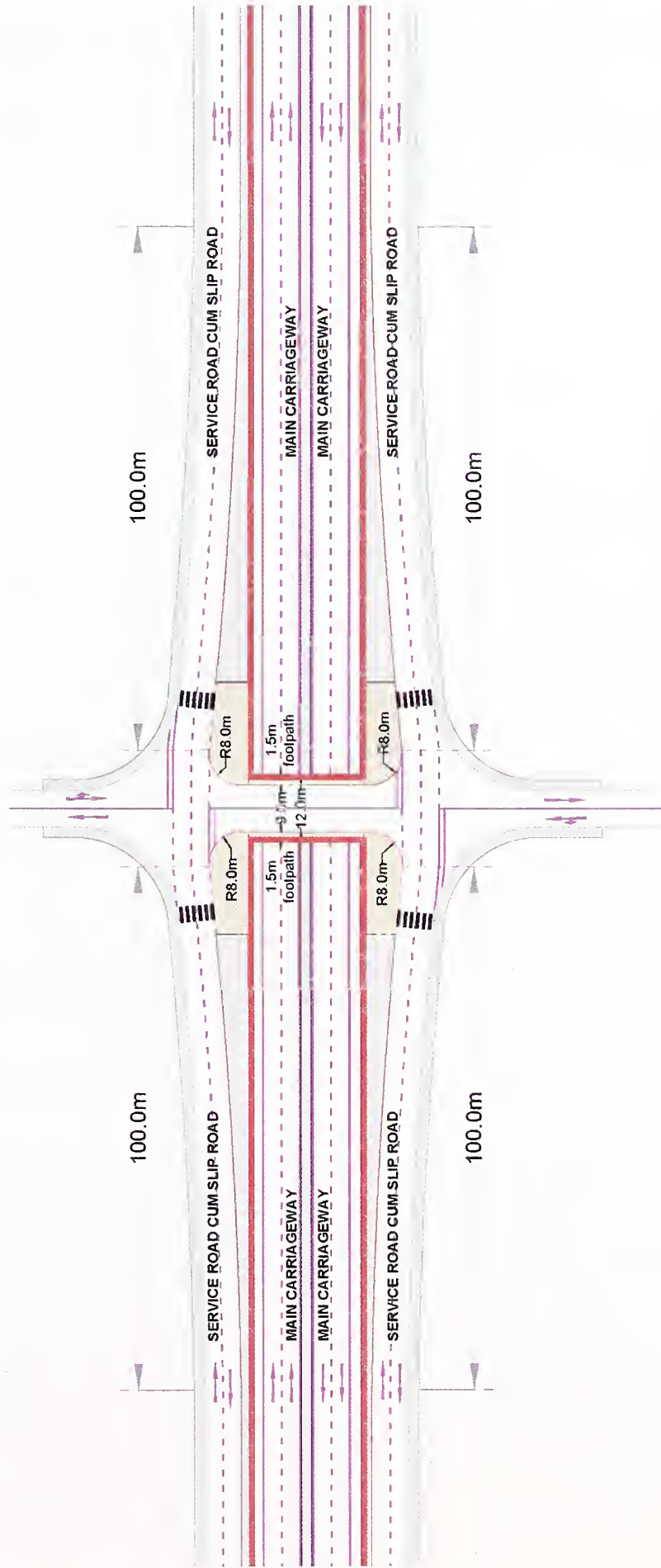

Fig 3.8 : Junction Layout below a VUP for Low Traffic Volume  
(Turning Radii for Light Commercial Vehicle)

**3.2.3** Cross roads shall join directly on to service roads and the entry to and exit from the Project Highway shall be through end connections as shown in **Figs. 2.1A to 2.1C**.

**3.2.4** The 4-lane highway encounters many at-grade maneuvering situations and the layout provided below are suggested for at-grade intersections on the project highway including that for U-turn.

**Fig. 3.1** Layout for T-Intersection (With Right Turn Protected Arrangement). The angle of interaction between project highway and side road shall never be less than 70 degree and shall be ensured for T-junction including new bypass junctions.

**Fig. 3.2** Layout for T-Intersection (With Protected U-Turn Arrangement). The U-turn arrangement shall be provided at locations where is indispensable and traffic warrants to provide such a facility).

**Fig. 3.3** Layout for Cross Road Intersection (With Right Turn Protected Arrangement). The 5 m wide median shall be continued to cater protected right turning. Moreover, wherever land permits, the median width shall be increased to 7 m to avoid narrow median width at storage lane location.

**Fig. 3.4** Layout for Staggered Intersection (With Right Turn Protected Arrangement). At location where geometry permits, skew road crossing shall be avoided by staggering side road on either side of Project Highway.

**Fig. 3.5** Left-in/Left out Arrangement. For right turn or U-turn, the nearest safe U-turn facility shall be used.

**Fig. 3.6** Self-Regulated U-Turn Facility. The Layout is applicable where encumbrance free land is available especially in rural reaches.

**Fig. 3.7** Layout for U-turn

In the above layouts, the width of right turning storage lane may be 3.0-3.5 m.

### **3.3 Grade Separated Intersections and Interchanges**

**3.3.1** An interchange is justified at locations where traffic on cross roads is moderate to heavy and for safe and efficient traffic flow, ramps are necessary for cross road traffic. The type and location of interchanges to be provided shall be specified in Schedule 'B'.

Encompassing safety requirement and also to have better traffic control following layouts are suggested for at-grade intersections below structures on the project highway.

**Fig. 3.8** Junction Layout below a VUP for Low Traffic Volume (Turning Radii for Light Commercial Vehicle)

**Fig. 3.9** Junction Layout below a VUP for Low Traffic Volume (Turning Radii for Trucks/Buses).

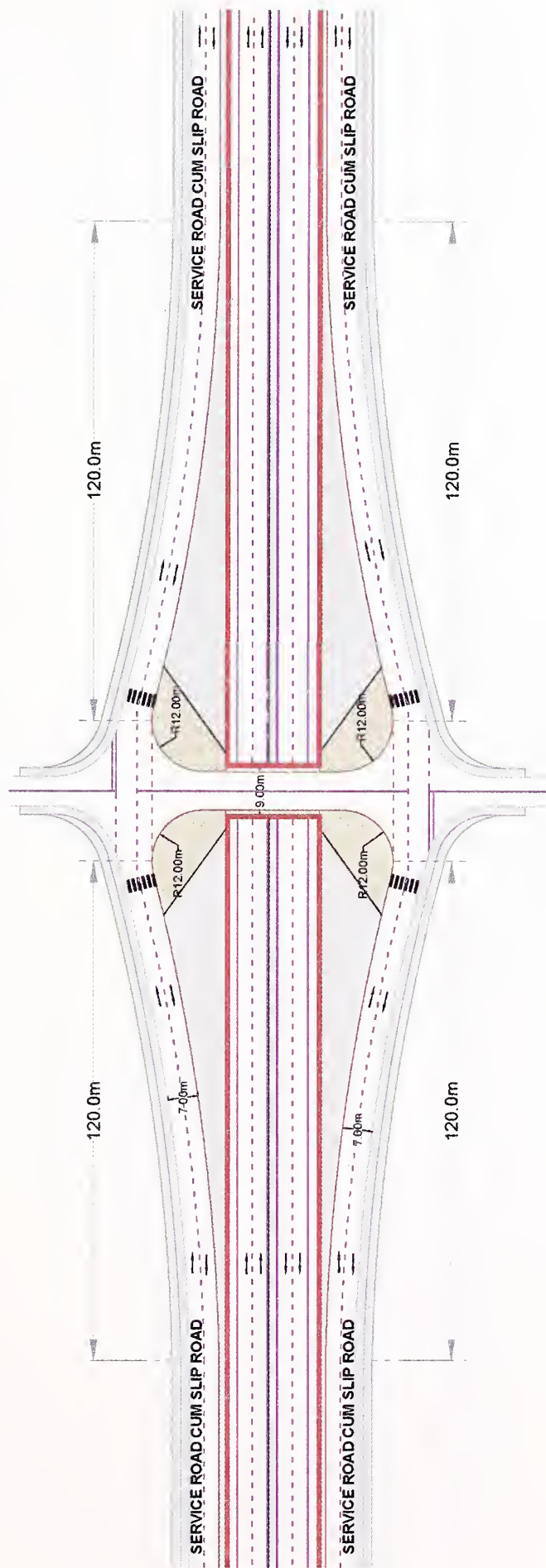

Fig 3.9 : Junction Layout below a VUP for Low Traffic Volume  
(Turning Radii for Trucks/Buses).

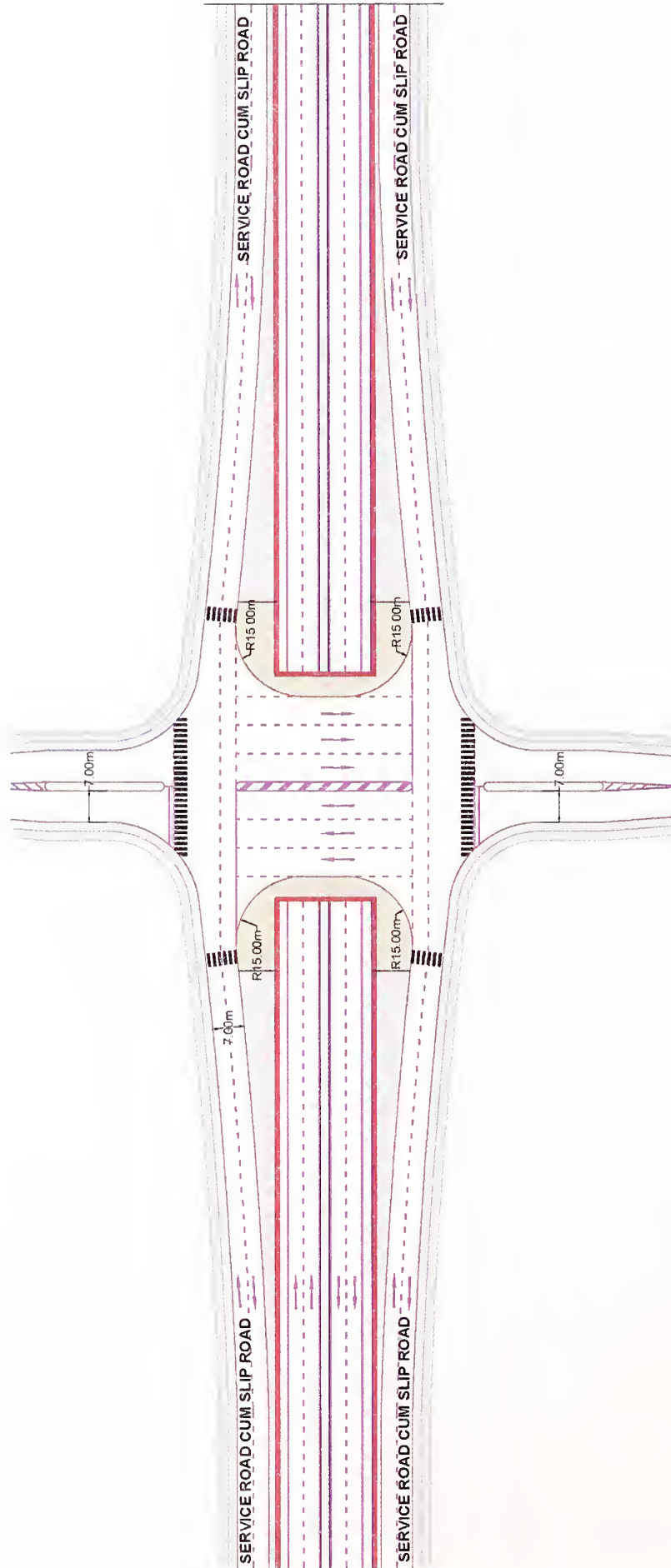
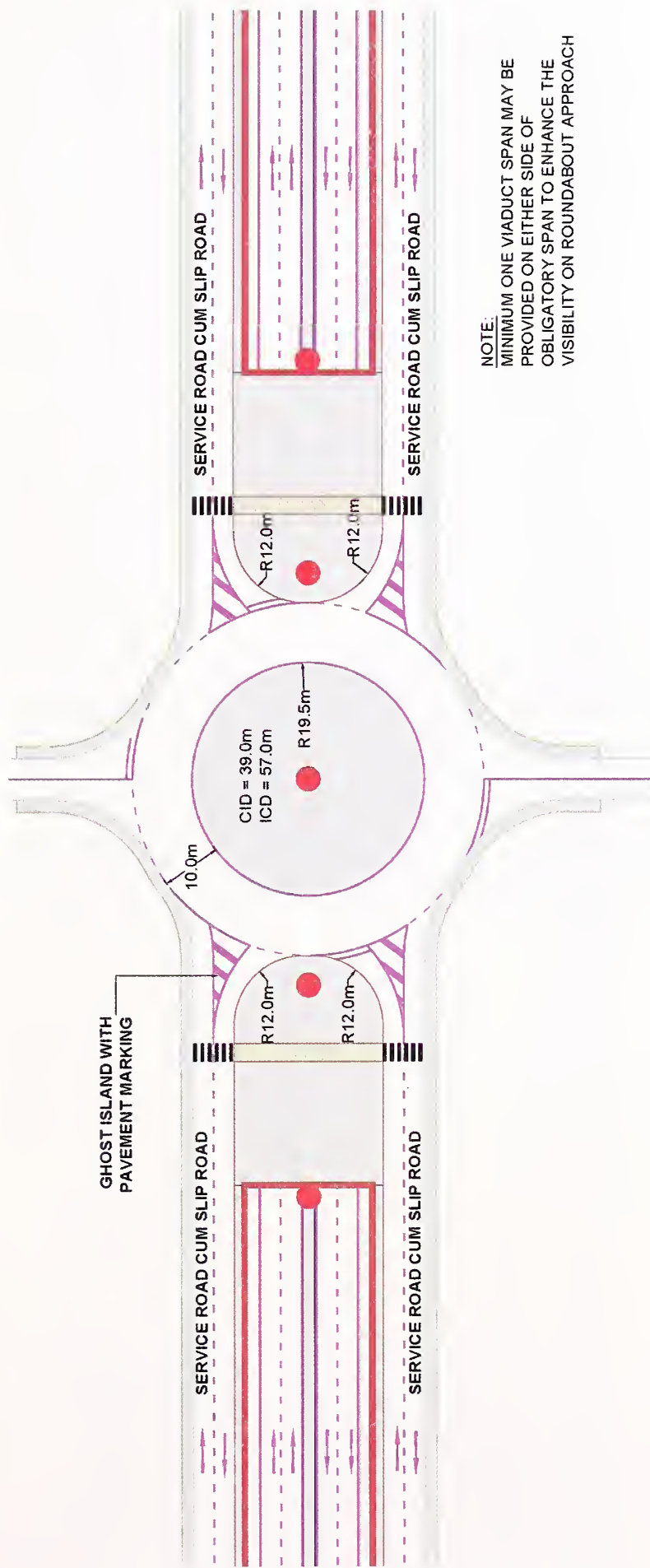

Fig 3.10 : Junction Layout for Medium Traffic Volume  
(Single Span Flyover & Control by Priority or Traffic Signal)



NOTE:  
 MINIMUM ONE VIADUCT SPAN MAY BE  
 PROVIDED ON EITHER SIDE OF  
 OBLIGATORY SPAN TO ENHANCE THE  
 VISIBILITY ON ROUNDABOUT APPROACH

Fig 3.11 : Junction Layout for Medium Traffic Volume  
 (Flyover with Viaduct Spans & Traffic Regulation by Roundabout).

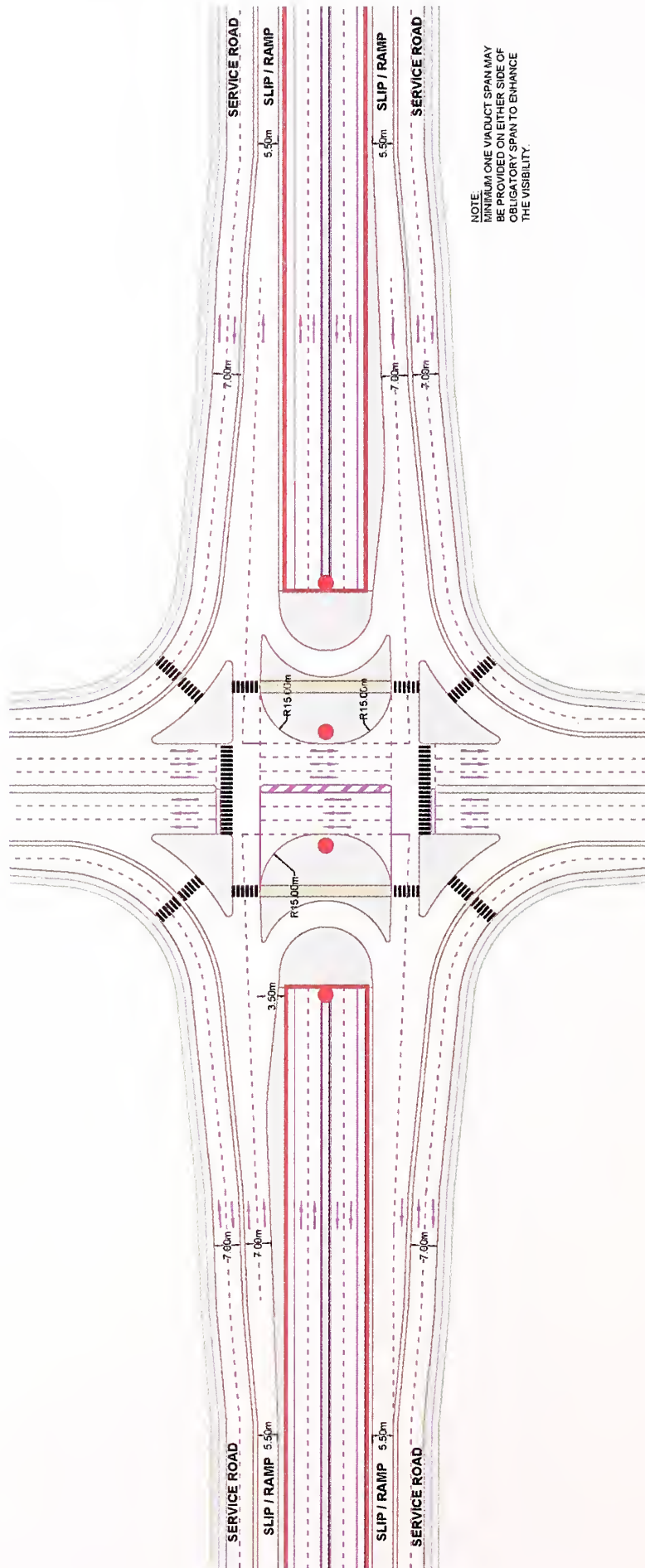
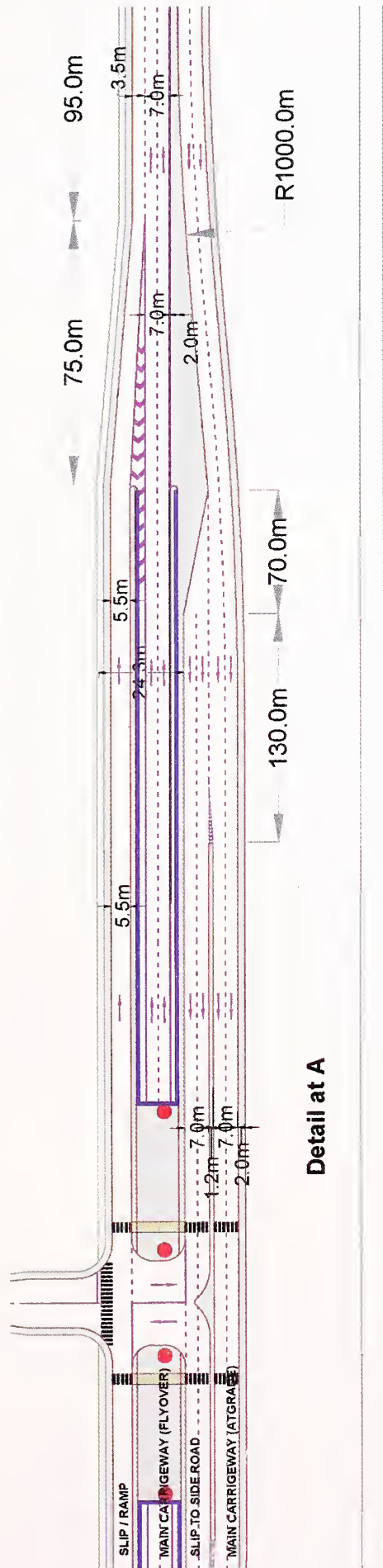

Fig 3.12 : Junction Layout for High Traffic Volume  
(Flyover with Viaduct Spans & Traffic Control by Signalization)





Detail at A

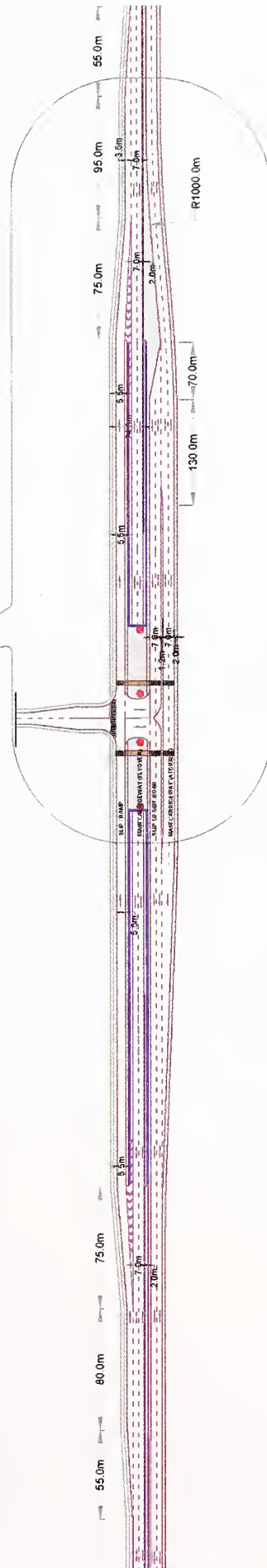

Fig 3.13 : Junction below a Half Flyover connecting Slip Roads

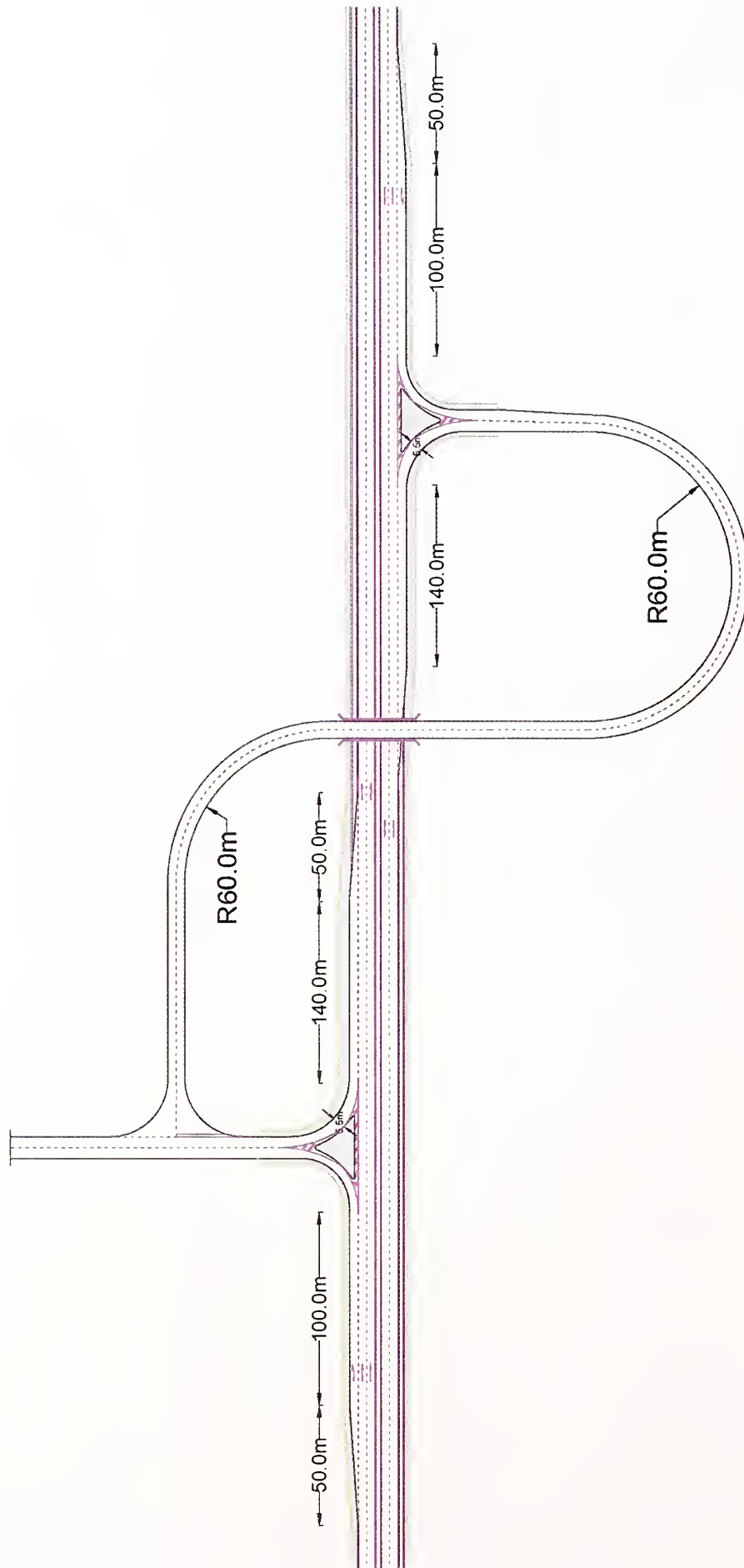

Fig 3.14 : Local Grade Separation for an Important Side Road  
(Two lane bridge over At-grade Project Highway)

- Fig. 3.10** Junction Layout for Medium Traffic Volume (Single Span Flyover & Control by Priority or Traffic Signal)
- Fig. 3.11** Junction Layout for Medium Traffic Volume (Flyover with Viaduct Spans & Traffic Regulation by Roundabout).
- Fig. 3.12** Junction Layout for High Traffic Volume (Flyover with Viaduct Spans & Traffic Control by Signalization)
- Fig. 3.13** Junction below a Half Flyover connecting Slip roads
- Fig. 3.14** Local Grade Separation for an Important Side Road (Two lane bridge over At-grade Project Highway)

### 3.3.2 *Geometric standards for design*

The geometric design standards for various elements of grade separators shall be as given in IRC:92. Gradient for approaches shall not be steeper than 2.5 percent (1 in 40).

### 3.3.3 *Design of structures*

Design of structures shall conform to Section 7 of this Manual. Minimum length of viaduct and that of and RCC Retaining Wall/RE wall required to be provided shall be specified in Schedule 'B'. In case length of Retaining/RE wall is not specified the same shall be deemed to be included in the scope of work and shall be provided as per site requirements.

### 3.3.4 *Lighting*

Lighting requirement shall be as per Section 12 of this Manual. The top and underside of the grade separated structures and interchange area at the ground level upto 50 m beyond the point from where flaring of the main carriageway takes place shall be provided with lighting.

## 3.4 **Detailed Design and Data for Review by the IE**

The Concessionaire shall submit the details of the ground surveys, traffic data, traffic forecast, design and drawings of the intersections and interchanges showing all safety features to the Independent Engineer for review and comments, if any.

## SECTION – 4

### EMBANKMENT & CUT SECTIONS

#### 4.1 General

**4.1.1** The design and construction of the road in embankment and in cuttings shall be carried out in accordance with Section 300 of MORTH Specifications and the requirements, and standards and specifications given in this Section. This Section also covers specifications for sub-grade and earthen shoulders.

**4.1.2** Efforts should be made to remove the inherent deficiencies in plan and profile of the existing road. The final centre line of the road and the road levels shall be fixed duly considering all the relevant factors covering structural soundness, safety and functional requirements as per relevant IRC Codes and provisions of this Manual.

**4.1.3** The existing road embankment shall be widened/modified to the specified cross-sectional details.

#### 4.2 Embankment

**4.2.1** The height of the embankment shall be measured with respect to the finished road levels. The following principles shall be kept in view while fixing the road level :

- i) No section of the road is overtopped. Top of subgrade shall be at least 0.5 m above the general ground level.
- ii) The bottom of sub-grade shall be 1.0 m above the High Flood Level (HFL)/ level of water table. The HFL should be decided by intelligent inspections, local observations, enquiries and studying the past records. This shall be relevant to situations where road alignment is sited within the flood plain or in the vicinity of water bodies or where ponding of water is encountered and cannot be efficiently drained. If raising of any section(s) of the existing road is required, the same shall be specified in Schedule 'B' of the Concession Agreement.

#### 4.2.2 *Materials and physical requirements*

**4.2.2.1** Sourcing of materials for embankment and sub-grade construction, as well as compliance with environmental requirements in respect of excavation and borrow areas under the applicable laws shall be the sole responsibility of the Concessionaire.

**4.2.2.2** The material to be used in sub-grade shall satisfy the design California Bearing Ratio (CBR) at the specified density and moisture content.

**4.2.2.3** The embankment and sub-grade shall be compacted to satisfy the minimum compaction requirements given in Clause 305 of MORTH Specifications.

### **4.2.3**      *Structural features and design of embankment*

**4.2.3.1**      Embankment with height 6.0 m more above shall be designed in accordance with IRC:75 taking into account slope stability, bearing capacity, consolidation, settlement and safety considerations based on geotechnical and investigation data. Where the embankment is to be supported on a weak stratum, appropriate remedial/ground improvement measures shall be taken.

**4.2.3.2**      Side slopes shall not be steeper than 2H:1V unless soil is retained by suitable soil retaining structures.

**4.2.3.3**      The side slopes and the earthen shoulders shall be protected against erosion by providing a suitable vegetative cover, kerb channel, chute, stone/cement concrete block pitching or any other suitable protection measures depending on the height of the embankment and susceptibility of soil to erosion. Drainage arrangement shall be provided as per Section 6 of this Manual. In high rainfall areas and where soil is susceptible to erosion, before providing turfing on slopes and shoulders, a coir or jute blanket shall be placed on such slopes and shoulders immediately after completion of work and in any event before onset of first monsoon after completion of work in that reach.

### **4.2.4**      *Use of pond ash for embankment construction*

Where pond ash is used for embankment construction in pursuance of the instructions of the Ministry of Environment and Forests or otherwise, the embankment shall be designed and constructed in accordance with IRC:SP:58.

## **4.3**          **Roadway in Cutting**

The road level shall be fixed, keeping in view the provisions of relevant IRC Codes.

## **4.4**          **Soil Investigations and Design Report**

### **4.4.1**      *General*

The Concessionaire shall carry out necessary soil surveys, and field and laboratory investigations for selecting appropriate borrow pits, identifying and treating problematic ground locations, if any, and for finalizing structural features and design of the embankment and cut sections and establishing improved ground properties. A report on the soil investigation shall be furnished along with the design.

### **4.4.2**      *Soil investigations for embankment*

Soil investigations shall cover the following:

- a) Soil investigations and tests in accordance with the requirements specified in IRC:SP:19 and shall be reported in the Proforma given in Table 1 of IRC:SP:19. In addition to this, all tests as per the requirements of MORTH Specifications shall be reported.
- b) In respect of embankments with height more than 6 m, additional investigations and soil tests as per IRC:75 and Appendix 10 of IRC:SP:19.

- c) Information regarding the topography, high flood level, natural drainage conditions, highest sub-soil water level, and the nature and extent of inundation, if any.
- d) The characteristics of embankment foundation including the presence of any unsuitable/weak strata, marshy areas, waterlogged areas, etc.
- e) Along the alignment of the road, where unstable strata, soft material or poor subsoil conditions have been met with at the foundation level, the soil profile shall be drawn after determining through borings, the type of soil at different levels. The borings shall be at maximum interval of 100 m to a depth of 2 m or more below the existing ground as necessary. In the case of high embankments, the borings shall be taken down to a depth equal to twice the height of the embankment.
- f) Any particular construction problems of the area or other important features.
- g) Geotechnical properties of pond ash, covering parameters specified in Table 1 of IRC:SP:58 and Optimum Moisture Content (OMC) - dry density relationship for heavy compaction. This information shall be furnished, in case pond ash is used in embankment construction.

#### 4.4.3 *Soil investigations for cut sections*

Soil investigations and tests shall be carried out in accordance with the requirements specified in IRC:SP:19 and information regarding depth of water table, seepage flow, presence of any weak, unstable or problematic strata.

#### 4.4.4 *Design report*

The Concessionaire shall prepare the design report with all relevant details including the following:

- i) Road Embankment
  - a) The detailed design of the embankment, remedial/ground improvement treatment where required. For embankments with height more than 6 m, construction methodology should also be included.
  - b) Design of retaining walls/reinforced earth structures.
  - c) Design of protection measures for embankment slope and drainage arrangement.
  - d) Design of pond ash embankment in case use of pond ash is proposed.
  - e) Any additional information relevant to the design of embankment.
- ii) Cut Section
  - a) Type of cutting involved and proposed cut slopes shall be provided in accordance with the nature of the soil encountered. Where required,

benching including use of slope stability measures like pitching, breast walls, etc. shall be adopted to make the slopes stable and safe

- b) Design and details of erosion control, slope protection measures, etc.
  - c) In cut sections in hilly terrain, the problem of seepage flow is common. Where such conditions exist, necessary measures shall be taken including provision of deep side drains to intercept the seepage flow and discharge the drained water into suitable outlets to avoid any damage to road and cut slopes. Design and details of drainage arrangement for sub-soil and surface water shall be furnished. It should be ensured that rain water and seepage water is quickly drained out. The gradient of drain shall not be flatter than 1 in 200.
  - d) Any other additional information relevant to the design of cut slopes.
-

## SECTION – 5

### PAVEMENT DESIGN

#### 5.1 General

**5.1.1** The design and construction of new pavement sections, and of strengthening measures (overlay) for the existing pavement shall be carried out in accordance with the criteria, standards and specifications given in this section. Where alternative specifications or materials are proposed to bring in innovation in design etc., provisions of Paras 1.9 and 1.11 of this Manual shall apply.

**5.1.2** The design of new pavement sections or strengthening of existing pavements shall take into account all relevant factors for assuring reliable performance and shall also satisfy the specified minimum performance requirements.

**5.1.3** The Concessionaire shall undertake the necessary soil, material and pavement investigations, traffic volume and axle load studies in accordance with the good industry practice for preparing detailed designs.

**5.1.4** The materials, mixes and construction practice shall meet the requirements prescribed in the MORTH/IRC Specifications.

**5.1.5** Where problematic conditions such as expansive soils, swamps or marshes, flooding, poor drainage, frost susceptible areas etc. are found to exist, adequate measures shall be adopted to deal with such site conditions.

#### 5.2 Type of Pavement

**5.2.1** Unless otherwise specified in Schedule 'B', the Concessionaire may adopt any type (flexible/rigid) of pavement structure for new construction.

**5.2.2** Strengthening of the existing flexible pavement will be carried out by providing appropriate bituminous overlay, unless specified otherwise in Schedule 'B' of the Concession Agreement.

**5.2.3** The Authority may require provision of cement concrete pavement on the new carriageway and/or replacement of existing pavement depending upon specific site conditions. Such requirements shall be as specified in Schedule 'B' of the Concession Agreement. The minimum design, construction, performance and maintenance requirements for cement concrete pavements will be specified by the Authority and Schedule 'K' of the Concession Agreement will be modified accordingly.

#### 5.3 Method of Design - New Pavements

##### 5.3.1 *Method of design of flexible pavement*

The new pavement shall be designed in accordance with the IRC:37 "Guidelines for the Design of Flexible Pavements".



### 5.3.2 *Method of design of rigid pavement*

Rigid pavement shall be designed in accordance with the method prescribed in IRC:58 “Guidelines for the Design of Plain Jointed Rigid Pavements for Highways”.

## 5.4 **Design Requirements for New Pavement Sections**

### 5.4.1 *Flexible pavement - design period and strategy*

- i) Flexible pavement shall be designed for a minimum design period of 15 years or operation period, whichever is more. Stage construction will be permissible subject to the requirements specified in para (ii) below.
- ii) Alternative strategies or combination of initial design, strengthening and maintenance can be developed by the Concessionaire to provide the specified level of pavement performance over the operation period subject to satisfying the following minimum design requirements.
  - a) The thickness of sub-base and base of pavement section is designed for a minimum design period of 15 years or the operation period, whichever is more and the initial bituminous surfacing for a minimum design period of 10 years.
  - b) The pavement shall be strengthened by bituminous overlay as and when required to extend the pavement life to full operation period. The thickness of bituminous overlay shall be determined on the basis of relevant IRC codes.

### 5.4.2 *Rigid pavement - design period and strategy*

- i) Rigid pavement shall be designed for a minimum design period of 30 years. The stage construction shall not be permitted.
- ii) The Pavement Quality Concrete (PQC) shall rest over Dry Lean Concrete (DLC) sub-base of 150 mm thickness.
- iii) A separation membrane shall be used between the PQC and DLC as per Clause 602.5 of MORTH Specifications.
- iv) The DLC shall meet the minimum cement and compressive strength requirement as prescribed in IRC:SP:49. The DLC shall extend beyond the PQC (including that in shoulder, if any) by 0.75 m on either side.
- v) Below DLC layer, a properly designed drainage layer Granular Sub Base (GSB) of 150 mm thickness shall be provided throughout the road width. It shall be designed to obtain a drainage coefficient of not less than 30 m per day.

**5.4.3** Pavement performance requirements for main carriageway, service roads, entry/exit ramps and acceleration/deceleration lanes shall be follows :

- i) The pavement structure shall be capable of giving the specified performance over the entire operation period.

- ii) The new pavement surface shall satisfy the following standards;
  - a) Surface Finish As per requirements of Clauses 902 and 903 of MORTH Specifications
  - b) Roughness in each lane Not more than 2000 mm/km for each lane in a km length
  - c) Rutting in wheel path measured by 3 m Straight Edge. Nil
  - d) Cracking or any other distress Nil
- iii) During the operation period, the pavement surface roughness or any structural or functional distress shall not exceed the values specified in Schedule 'K' of the Concession Agreement. Generally the pavement condition in terms of roughness, cracking and rutting should not deteriorate to the maximum values specified in Schedule 'K' for rectification, earlier than 5 years from the original level from the year of rectification. Any treatment in the form of renewal/overlay carried out or required to restore/correct/improve the riding quality or any distress shall be of such thickness and specification that will restore the riding quality to roughness not exceeding 2000 mm/km.
- iv) During the operation and maintenance period, the pavement strength shall be evaluated periodically through deflection measurements (Refer to Para 5.8 (ii) of this Section) and the stretches exhibiting any structural deficiency shall be rectified. If the deflection measurements are more than 1.2 mm, the pavement shall be strengthened in those reaches.

**5.4.4** The performance of the rigid pavement shall meet the requirements as specified in IRC:SP:16 and IRC:SP:83.

## **5.5 Design Traffic**

**5.5.1** The design traffic shall be estimated in terms of cumulative number of standard axles (8160 kg) to be carried by the pavement during the design period.

**5.5.2** Initial daily average traffic flow shall be assessed based on IRC:9.

**5.5.3** Any likely change in traffic due to proposed four laning of the facility and/or future development plans, land use, shall be duly considered in estimating the design traffic.

**5.5.4** Traffic growth rate shall be established for each category of commercial vehicles to be considered for design of pavement. For traffic projections, the procedure outlined in IRC:108 may be followed. The Concessionaire shall adopt a realistic value of the rate of traffic growth, provided that annual rate of growth of commercial vehicles adopted shall not be less than 5 percent.

**5.5.5** The design traffic in case of service road shall be ten million standard axles. The crust composition shall be provided accordingly.

## 5.6 Sub-grade

The Sub-grade, whether in cut or fill, shall meet the requirements stipulated in Clause 305 of MORTH Specifications. The thickness of sub-grade shall not be less than 500 mm.

## 5.7 Pavement Components and Materials

- i) The pavement construction materials for sub-base, base and bituminous surfacing shall conform to the requirements prescribed in MORTH Specifications and IRC Standards.
- ii) Where several materials will adequately serve as component within the pavement structure, such as a sub-base or a base course, the Concessionaire shall have the option of using any of the materials specifications, subject to sound engineering practice and product quality requirements.

## 5.8 Performance Evaluation

- i) Roughness in each lane for full length shall be measured twice a year using appropriate approved method and equipment.
- ii) The structural evaluation of the pavement shall be made by taking deflection measurements every 5 years in accordance with the procedure given in relevant IRC codes, unless needed earlier, for stretches exhibiting severe distress during the operation and maintenance period.

## 5.9 Strengthening of Existing Pavements

**5.9.1** Before strengthening treatment is prescribed, a detailed pavement condition survey and evaluation shall be carried out in accordance with relevant IRC codes to determine.

- i) The extent of distress and nature of deficiency in the existing pavement structure, and
- ii) Whether any special treatments e.g. provision for remedying reflection cracking, pavement internal drainage, sub-grade improvement reconstruction, or rectification of any other deficiencies are warranted.

**5.9.2** Necessary corrective measures to treat the identified deficiency shall be taken along with strengthening of the pavement.

**5.9.3** In stretches where the pavement is damaged/deteriorated to such an extent that the use of Falling Weight Deflectometer (FWD) may not result in a realistic assessment of the strengthening treatment, pavement shall be designed as new pavement.

**5.9.4** Where an existing pavement is built over an untreated expansive/black cotton soil sub-grade, its improvement strengthening shall be treated separately. Such stretches shall require reconstruction with provision of necessary measures such as replacement treatment of expansive sub-grade, drainage, etc. as per the prescribed specifications and IRC:37; and shall be designed as new pavement. Stretches to be reconstructed, whether due to

expansive sub-grade or having grossly deteriorated, etc. shall be specified in Schedule 'B' of the Concession Agreement.

**5.9.5** No granular layer shall be provided over an existing bituminous surfacing. Situations may arise where it is envisaged to strengthen grossly deficient existing road with a granular layer in addition to the bituminous overlay, or where for camber and/or grade correction substantial thickness of profile corrective course is needed. In such cases, the existing bituminous surfacing shall be completely removed by scarifying/milling and then the pavement built up with the granular layer(s) and bituminous overlay. The thickness and composition of bituminous surfacing (Binder course and Wearing course) over the granular layer shall conform to IRC:37.

**5.9.6** *Design of overlay*

- i) The thickness of the bituminous overlay shall be determined on the basis of FWD (Ref. IRC:115-2014) method and the design traffic as per the procedure outlined In IRC:81 as also from structural numbers of existing pavement layers.
- ii) The design period will be the same as specified for the new pavement sections vide Para 5.4.1 of this Section. The initial-strengthening shall be done for a minimum design period of 10 years. Subsequent strengthening to extend the pavement to full operation period shall be implemented at the end of initial in design period or earlier, in case of any structural distress in the pavement [refer Para 5.4.3 (iv) of this Section] or if the surface roughness exceeds the value specified In Schedule 'K' of the Concession Agreement.
- iii) The design traffic will be estimated as per the procedure described for new pavement.
- iv) The thickness of bituminous overlay for pavement strengthening shall not be less than 50 mm bituminous concrete, after attending to the requirements of profile corrective course.

**5.9.7** *Bituminous mix for overlay*

- i) The specifications for the bituminous mixes for the overlay shall be as specified for bituminous surfacing for new pavement sections.
- ii) Design of recycled mix where provided shall conform to the requirements of Clause 519 of MORTH Specifications.

**5.9.8** *Pavement performance requirements and evaluation*

- i) The strengthened pavement shall satisfy the minimum standard and maintenance requirements specified for new pavement sections in this Manual and Schedule 'K' of the Concession Agreement.
- ii) The performance measurement and evaluation will be done as given in this Manual.

### 5.10 Paved Shoulders and Paved Median Strips

- i) Paved shoulders and strip on median side shall be of same specification and composition as of new pavement of main highway.
- ii) Where existing pavement /paved shoulder is proposed to be used as carriageway it shall be capable of taking design traffic load as applicable for main highway.

### 5.11 Construction, Workmanship and Quality of Works

All materials, construction operations, workmanship, surface finish and quality of completed construction for all pavement works including sub-grade, sub-base, base course, bituminous surface courses for both new pavement and strengthening of existing pavements, shoulders, service roads, etc. shall conform to the specified requirements and comply with the provisions of Section 900 of the MORTH Specifications

### 5.12 Premature Distress

Notwithstanding the minimum design, specifications and standards specified in the preceding paras for new pavements and strengthening of existing pavements, if the pavement shows premature distress in the form of cracking, rutting, patching, loss of camber or any other structural or functional distress, necessary remedial measures by strengthening/resurfacing/recycling shall be undertaken for conforming to the minimum requirements prescribed in Schedule 'K' of the Concession Agreement. In case of repetition of the distress, reconstruction shall be resorted to after proper investigations.

### 5.13 Detailed Design Report

**5.13.1** The new pavement design and strengthening proposals formulated on the basis of the detailed investigations and studies shall be submitted to the Independent Engineer along with Data Collection, Data Evaluation and Design Reports

#### 5.13.2 *Data collection*

Following details shall be included in the report:

- i) Soil investigation data for new pavements as per **Table 13.2** of IRC:SP:19. Report shall include OMC-dry density relationship with heavy compaction and soaked CBR values in addition to other data and information as per the prescribed Proforma.
- ii) Test values of aggregate for pavement courses as per **Tables 13.3 and 13.4** of IRC:SP:19. All tests as per requirements of MORTH Specifications shall be reported in addition to the tests and information included in the above mentioned Tables.
- iii) Classified traffic counts in Proforma 1 of IRC:SP:19.
- iv) Axle load surveys and VDF values for each category of commercial vehicles as per Proforma 4 of IRC:SP:19.

- v) Estimation of traffic growth and traffic projections for pavement design.
- vi) Pavement condition data as per relevant IRC code.
- vii) Pavement roughness data determined through appropriate method as approved by the Authority.
- viii) Pavement Deflection Data measured as per relevant IRC codes.
- ix) Any other relevant information required by the Independent Engineer for review and comments, if any.

### **5.13.3** *Data evaluation*

The report shall inter alia cover;

- i) Data evaluated - soil characteristics and sub-grade strength, pavement distress, pavement deflection, riding quality, skid resistance, drainage aspects etc.
- ii) Pavement deficiencies, drainage and constraints.
- iii) Any other relevant details.

**5.13.4** The Report shall contain the detailed design of the preferred solution along with any special treatment proposed for adoption. Any departures from the specifications stated herein shall be supported with authentic standards and specifications and accepted practice.

## SECTION – 6

### HIGHWAY DRAINAGE

#### 6.1 General

**6.1.1** The design and construction of surface and subsurface drains for highway drainage and drainage for structures shall be carried out in accordance with the requirement of this Section.

**6.1.2** For efficient drainage system for the entire Project Highway including structures, directions contained in Clause 309 of MORTH Specifications, IRC:SP:42, IRC:SP:50 and IRC:SP:90 as relevant shall be followed.

**6.1.3** In road sections in cuttings and at underpasses where it may not be possible to drain out the water using gravity flow, vertical drains may be planned and if necessary, arrangement for pumping shall also be made.

#### 6.2 Surface Drainage

**6.2.1** The selection of type of roadside drains shall be based on the magnitude and duration of flow. The roadside drains shall be designed on the principles of flow in open channel.

**6.2.2** The road side drains shall not pose any danger to traffic, slopes of cuttings, embankment, pavement or structures.

**6.2.3** As far as possible, longitudinal slope shall not be less than 0.3 percent for lined drains and 1.0 percent for unlined drains. Permissible non-erodible flow velocity for corresponding earth surface as mentioned in Clause 9.4 of IRC:SP:42 shall be kept in view.

**6.2.4** The side slopes of the unlined drains shall be as flat as possible and shall not be steeper than 2H:1V.

**6.2.5** RCC/ Cement Concrete drains shall be provided in the following situations:

- i) When due to space constraint, the drains are located near the toe of the embankment or near structures.
- ii) Drains located in built-up areas.
- iii) Flow velocity is more than 1 m/s in silt and sand; and more than 1.5 m/s in stiff clay.

**6.2.6** In built-up areas, covered RCC/Cement Concrete or piped drains, with manholes at suitable intervals to de-silt the drains shall be provided.

**6.2.7** The drainage of cross roads shall be maintained. RCC Box of sufficient size shall be provided across the cross road to maintain the longitudinal drainage along the Project Highway.

### **6.3 Median Drainage**

**6.3.1** In case of depressed median, longitudinal drain (lined or unlined) shall be provided to drain off rain water. The drain should have adequate longitudinal slope to the nearest culvert to drain off transversely. In super elevated sections the longitudinal drains should be designed to take the discharge from one side carriageway also.

**6.3.2** Median shall be turfed or paved and could be crowned for drainage across the pavement. In super elevated sections combination of covered longitudinal and cross drains shall be provided.

### **6.4 Drainage where Embankment Height is more than 6 m**

**6.4.1** In embankments with height more than 6 m and approaches to bridges, special arrangement for protection of embankment slopes shall be essential in order to ensure that embankment slopes maintain their shape during the monsoon season. In this respect, directions contained in Clause 7 of IRC:SP:42 may be followed as appropriate for the climatic conditions of the area of the Project Highway.

**6.4.2** Drainage arrangement shall include provision of kerb with channel at the edges of the roadway to channelise the water and Cement Concrete (CC) lined chutes along the slopes at designed intervals with energy dissipation basin, side channels at the bottom protection of the slope by turfing, vegetation and/or any other suitable type. The drainage system and slope protection shall be kept well maintained at all times.

**6.4.3** The chute drains and drains at toe of the embankment shall be of Plain Cement Concrete (M15 grade), over bedding in Cement Concrete M 10.

### **6.5 Catch Water Drains**

**6.5.1** Suitable catch water drains shall be provided on the hill slope above cutting to collect and remove surface water run-off from upper reaches. These drains shall be of trapezoidal shape with stone lining pointed with cement and sand mortar.

**6.5.2** The catch water drains shall be designed to carry the intercepted water to the nearest culvert or natural drainage channel.

**6.5.3** It shall be ensured that the catch water drains are provided in stable hill slopes outside the periphery of slide/unstable areas.

**6.5.4** Where required lined chutes shall be provided to lead the discharge to the catch pit of culvert or to a natural drainage channel.

### **6.6 Sub-surface Drains**

**6.6.1** The sub-surface drainage shall be provided

- i) for lowering the water table required for drainage of sub-grade;
- ii) to intercept or drain out free water in cut slopes; and
- iii) For drainage of pervious sub-base in situations where it may not be practicable to extend the sub-base across the shoulder.



- 6.6.2** Sub-surface drains shall not be used for surface drainage.
- 6.6.3** The sub-surface drains shall be:
- i) Close jointed perforated pipes or open jointed unperforated pipes in trenches with backfill material around pipes.
  - ii) Aggregate drains consisting of free draining material in the trench without any pipe.
- 6.6.4** Perforated pipes and unperforated pipes shall meet the requirements of Clause 309.3 of the MORTH Specifications.
- 6.6.5** The internal diameter of the pipe shall not be less than 150 mm.
- 6.6.6** The sub-surface drains shall be located not less than 0.5 m below the sub-grade.
- 6.6.7** *Backfill material*
- i) Backfill material shall be free draining sand gravel or crushed stone designed on inverted filter criteria for filtration and permeability, or of an appropriate grading conforming to the requirements of Table 300.3 of the MORTH Specifications.
  - ii) Thickness of backfill material around the pipe shall not be less than 150 mm. The minimum thickness of material above the top of the pipe shall be 300 mm.
- 6.6.8** Sub-surface drains outside the road pavement shall be sealed at the top to avoid percolation of surface water into these drains.
- 6.6.9** *Use of Geo-textile*
- i) The sub-surface drains may be designed using appropriate geo-textile to serve the functions of filtration and separation.
  - ii) The sub-surface drains can be provided with geo-textile either along the trench or around the pipe or both.
  - iii) The geo-textile shall satisfy the requirements of Clause 702 of the MORTH Specifications.
- 6.6.10** Trench excavation, laying of pipe, backfilling, and use of geo-synthetics shall confirm to the requirements of Clause 309.3 of the MORTH Specifications.
- 6.6.11** The drain outlet shall be a free outlet and shall be provided as per Clause 309.3 of the MORTH Specifications.
- 6.6.12** *Aggregate drains*
- i) The trench for aggregate drain shall be of minimum 300 mm width and cut to a depth to expose the granular pavement courses to be drained.
  - ii) Aggregate for the drain shall be gravel, stone aggregate or slag of grading as per Table 8 of IRC:SP:42.

- iii) The aggregate drain shall be provided with a geo-textile wrap to act as filtration and separation layer.

**6.6.13** Design of subsurface drainage shall be based on a rational basis. Reference may be made to IRC:SP:42.

## **6.7 Internal Drainage of Pavement Structure**

- i) Boxed type construction in which pavement is housed in earthen shoulders shall not be provided.
- ii) The sub-base shall be extended across the shoulders for efficient drainage of pavement.
- iii) The granular sub-base shall be of proper design and grading to perform satisfactorily as a drainage layer. The drainage layer shall not have material finer than 75 micron size.
- iv) A suitable filter of granular material or geo-textile to act as filtration and separation layer shall be incorporated, where necessary, between the sub-grade and sub-base to prevent clogging.

## **6.8 Drainage for Structures**

### **6.8.1 *Culverts and bridges***

**6.8.1.1** For culverts and bridges provision of suitable cross slope/camber and down take pipes/spouts near the kerb, covered with gratings at the inlet points shall be provided at regular interval to facilitate rapid draining of water from the deck without any ponding. The length and location of these drainage spouts should be such that the water is not discharged on any bridge element.

**6.8.1.2** The bridges particularly those in high rainfall area shall preferably be built in longitudinal gradient with suitably designed cross drains at abutment locations to facilitate proper drainage.

### **6.8.2 *Grade separators/flyovers/road over bridges***

**6.8.2.1** Effective drainage shall be provided both longitudinally and transversely. The transverse drainage shall be secured by means of suitable camber in the roadway surface. Longitudinal drainage shall be secured by means of scuppers, inlets, or other suitable means of sufficient size and numbers to drain the run-off efficiently.

**6.8.2.2** Efficient drainage of the deck structure shall be ensured by providing a suitably designed drainage arrangement consisting of drainage spouts connected to horizontal and vertical pipe system such that the water from the structure does not fall on the road, does not stagnate over the road or at entry and exit points of grade separated structure and is discharged into the draining system of the area. Care must be taken that the pipes are taken down in such a way that they are aesthetically pleasing.

**6.8.2.3** Typically, water spouts are provided at the kerbs at the rate of 1 No. per 12 sqm of the surface in level portions and 1 No. per 15 sqm of the surface area on gradients. Water

spouts are connected to runner pipe of suitable diameter (minimum 100 mm) on either side of roadway and taken down by downtake pipes at pier & abutment locations.

**6.8.2.4** Drainage fixtures and downspouts shall be of rigid, corrosion resistant material not less than 100 mm as the least dimension and shall be provided with suitable cleanout fixtures.

**6.8.2.5** The arrangement of floor drains shall be such as to prevent the splashing discharge of drainage water against any portion of the structure. Overhanging portions of concrete floors shall be provided with drip moulds.

**6.8.2.6** Catch water drains are necessary at the ends of viaduct portion so that water coming from grade separated structure does not over saturate and affect the earthen embankment. Similar catch water drains should be provided at the end of gradient so that water coming from the structure is properly let out to nearest drain.

**6.8.2.7** An integrated drainage plan for the water coming from the deck of structures, local catchment area of the project and all other sources should be prepared so that no water falls on any surface of the structures, or remain standing or flowing over the level roads. All the water is collected through sumps and finally discharged into the local drainage system i.e. storm water drain/pipes etc. either by gravity through connecting drains or by pumping into the existing outgoing drains.

**6.8.2.8** The rainwater from the deck of the structures usually does not flow transversely but flows on the high gradient slopes of the road or approaches and is collected in the valley curve portion. As such attention is to be paid to get this large quantity of water drained out fast without accumulating there causing problems for traffic flow resulting in traffic jams. The draining out systems should be designed with greater margins so as to avoid this problem, a least for grade separators, inside the cities or inhabited areas.

### **6.8.3** *Underpasses and subways*

**6.8.3.1** Where rain water cannot flow into the drainage system by gravity due to the requirement of depressed road to get minimum head room, necessary provision for drainage by vertical drains and/or pumping shall be made so that there is no disruption of traffic through such location on account of water logging/flooding of underpass or subway.

## **6.9 Existing Drains, Canals and Minor Waterways**

**6.9.1** For the existing drains, canals and waterways, to be over passed by the highway, draining provisions shall be maintained and the effects of prolonged heavy rainfall must be catered for.

**6.9.2** Special attention shall be paid to the drainage channels carrying industrial waste and effluent in particular to those draining chloride contaminated effluents which are detrimental to the RCC structures.

**6.9.3** Adequate care shall be taken while crossing irrigation canals to prevent contamination of the flow in the canal by spillage from the highway.

**6.9.4** When highway runs parallel to existing channels, adequate measures shall be taken in the form of bank protection and channel alignment to avoid water build up or stagnation against the highway slope endangering the pavement drainage. The drainage channels at the toe of the highway may have to be adequately protected or reshaped for discharge in to these channels. Where the discharge from road drainage is not permitted, separate cross drainage structures are to be provided on both sides of such channel.

## **6.10 Survey, Investigation and Design Report**

The Concessionaire shall carry out proper surveys and investigations for detailed design of the drainage system. The proposal for drainage system supported with survey investigation report and detailed design report shall be submitted to the Independent Engineer for review and comments, if any.

### **6.10.1 Drainage studies**

The survey and investigation and drainage studies shall include :

- i) Alignment plan, longitudinal and cross sections, contour map.
- ii) Hydrological data.  
Drainage area, water shed delineation, direction of flow, location of outfalls, existing surface drains, ground surface condition, rainfall , flood frequency, etc.
- iii) Data for hydraulic design of drains.
- iv) Gee-technical investigations for sub surface strata, level of water table, seepage flow etc.
- v) Identification of areas requiring sub-surface drainage.
- vi) Any other relevant information. Guidance may be taken from IRC:SP:19, IRC:SP:42, IRC:SP:48 and IRC:SP:50 may be referred to.

### **6.10.2 Design details**

The report shall include:

- i) Estimation of design discharge.
- ii) Design of surface drains.
- iii) Design of sub-surface drains.
- iv) Drainage arrangement plan along with plan, longitudinal section and cross section of drains integrated with cross drainage works and a strip chart.
- v) Specifications of drains.
- vi) Any additional information as required by the IE for review of the drainage system.

### **6.10.3 Responsibility for design and adequacy**

The Concessionaire shall be fully responsible for design and adequacy of the drainage system throughout the operation period as per the requirements of the Concession Agreement.

## SECTION – 7

### DESIGN OF STRUCTURES

#### 7.1 General

- i) All structures shall be designed in accordance with the relevant Codes, Standards and Specifications, Special Publications and Guidelines of the IRC. Construction of all culverts, bridges and grade separated structures shall conform to MORTH Specifications for Road and Bridge Works.
- ii) All bridges and grade separated structures shall have independent superstructure for each direction of travel unless specified otherwise in Schedule 'B'. Culverts may have single or independent superstructure.
- iii) All bridges shall be high level bridges.
- iv) In built-up sections viaduct spans shall be provided in the approaches of the structure. However, embankment/RE wall/Retaining wall may be provided upto 5 m height. For this purpose the height shall be measured from existing road level.
- v) The width of median in the culvert and bridge portion shall, as far as possible, be kept same as that in the approaches. In case width of median is different from that of approach section due to site constraints, transition of 1 in 30 shall be provided near approaches for guiding vehicular traffic.
- vi) The median in the portion of structures shall be treated as below:
  - a) A suitably designed catch pit shall be provided to collect and carry discharge from median drain.
  - b) The median shall be open to sky. The safety barrier on the median side shall be provided at a clear distance of 0.5 m from the edge of carriageway.
- vii) Suitable provision shall be made for retaining the earth in the median portion either by extending the abutment wall or constructing a new retaining wall. The abutment wall shall have provision for taking the discharge from the median. Care shall also be taken to merge the wing wall/return wall and flooring of the old bridge with those of the new bridge.
- viii) Any utility service to be carried by the structures shall be specified in Schedule 'B' of the Concession Agreement.

#### 7.2 Design Loads and Stresses

- i) The design loads and stresses shall be as per IRC:6 appropriate for the width of carriageway, velocity of stream, location, altitude, environment, etc.
- ii) All new structures shall be designed for the condition when footpath is used as carriageway. The footpath portion may be provided at the same level as

the bridge carriageway and separated by crash barrier in non built-up areas. In built-up areas, raised footpaths shall be provided.

- iii) All the components of structures shall be designed for a service life of 100 years except appurtenances like crash barriers, wearing surface and rubberized components in expansion joints and elastomeric bearings. All the requirements to achieve durability and serviceability shall be implemented

### 7.3 Width of Structures

Width of the culverts and bridges shall be adopted as below:

#### i) New culverts

Overall width of all new culverts shall be equal to roadway width of the approaches. The outer most face of railing/parapet shall be in line with the outer most edge of shoulder. Typical cross-section of the new culverts for a 4-lane project highway is given in **Figs. 7.1A and 7.1B**.

#### ii) New bridges

a) All new bridges shall have a footpath on left side of the traffic direction. The overall width of new bridges with a footpath on left side shall be same as the roadway width of the approaches. The crash barrier (raised kerb in case of bridges in built up areas) shall be provided at the edge of the paved shoulders with 0.5 m shy distance. However, in case a separate bridge is to be provided for service road at the same location, then the footpath shall be provided for the bridge on the service road. The overall width of new bridge in such cases will be less than the approach width up to the crash barrier at the edge of the paved shoulder with 0.5 m shy distance. Typical cross sections of new bridge with footpath (no service road bridge) and without footpath (with service road bridge) for a 4-lane Project Highway are given in **Figs. 7.2A and 7.2B** respectively.

b) Where the daily traffic in PCU exceeds 30,000 at the time of feasibility study/bidding, the width of new bridge shall be as per Six-lane standards vide details given in **Fig. 7.3** with footpath. Such bridges shall be indicated in Schedule 'B'.

#### iii) Existing culverts

a) All culverts which are structurally distressed or not having sufficient vent size or unsafe for design loads due to surcharge like in approaches to structures shall be reconstructed as new structures of width as per Sub Para 7.3 (i) of this Section.

b) All existing culverts which are not to be reconstructed shall be widened equal to the roadway width of the approaches.

c) The culverts and Hume pipe structures shall be widened so as to make the deck width same as specified in Sub Para 7.3 (i) of this Section. If

the width of additional widening is less than 0.5 m on either side, the widening of the structure may be dispensed with and traffic shall be guided with the help of crash barriers in a transition of 1 in 20 on either side approaches.

- d) List of culverts to be reconstructed and/or widened shall be specified in Schedule 'B' of the Concession Agreement.

#### iv) Existing bridges

- a) All bridges which are structurally distressed shall be reconstructed as new bridges of width as per Sub Para 7.3 (ii).
- b) Components like bearings, expansion joints, railings, crash barriers, wearing surface, etc., which are not in sound condition, shall be replaced. Minor non-structural works shall be suitably repaired as per Para 7.22.
- c) If the width of additional widening is 1.0 m (0.5 m on each side) or less, the widening of the structure may be dispensed with and traffic shall be guided with the help of crash barriers in a transition of 1 in 20 on either side approaches.
- d) The bridges having 2-lane carriageway particularly those with T-beam/ Box type superstructure with well/pile foundation, which are in sound condition, may be retained and proper transition between approach and bridge shall be provided. Typical cross-sections at deck level for bridges with and without footpaths showing new bridge on one side and existing 2-lane bridge on the other side are given in **Figs. 7.4A** and **7.4B** respectively. Correspondingly typical cross-sections for six lane bridge are given in **Figs. 7.5** to **7.7**. The wearing course, bearings and rubberized component of expansion joints which are damaged or older than 15 years in the existing bridge shall be removed and replaced and all repair and rehabilitation required shall be carried out before commissioning of the Project Highway.
- e) The width of the new structures constructed on the other side of the existing bridge shall be as specified in Sub Para 7.3 (ii) of this Section.
- f) List of bridge structures to be reconstructed and/or widened shall be specified in Schedule 'B' of the Concession Agreement.

## 7.4 Structure Types

The Concessionaire may adopt any type of structure and structure system commensurate with safety, serviceability and durability requirements. General guidelines as below shall be followed:

- i) The structure should aesthetically blend with the environment.

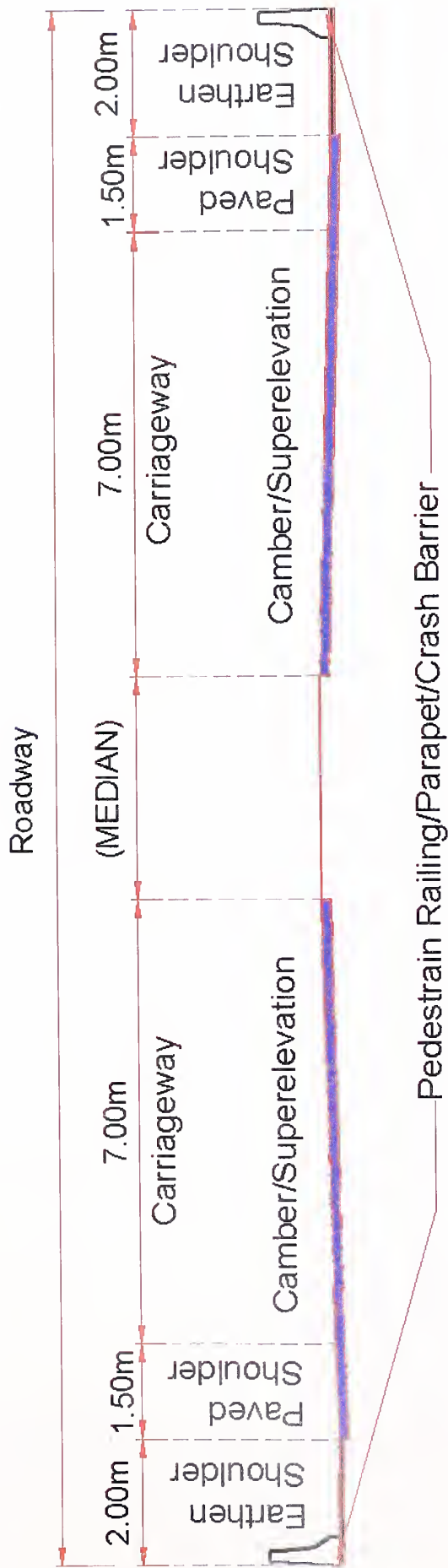

Fig. 7.1A : Cross Section of Pipe Culvert at Road Level  
4 Lane Divided Highway

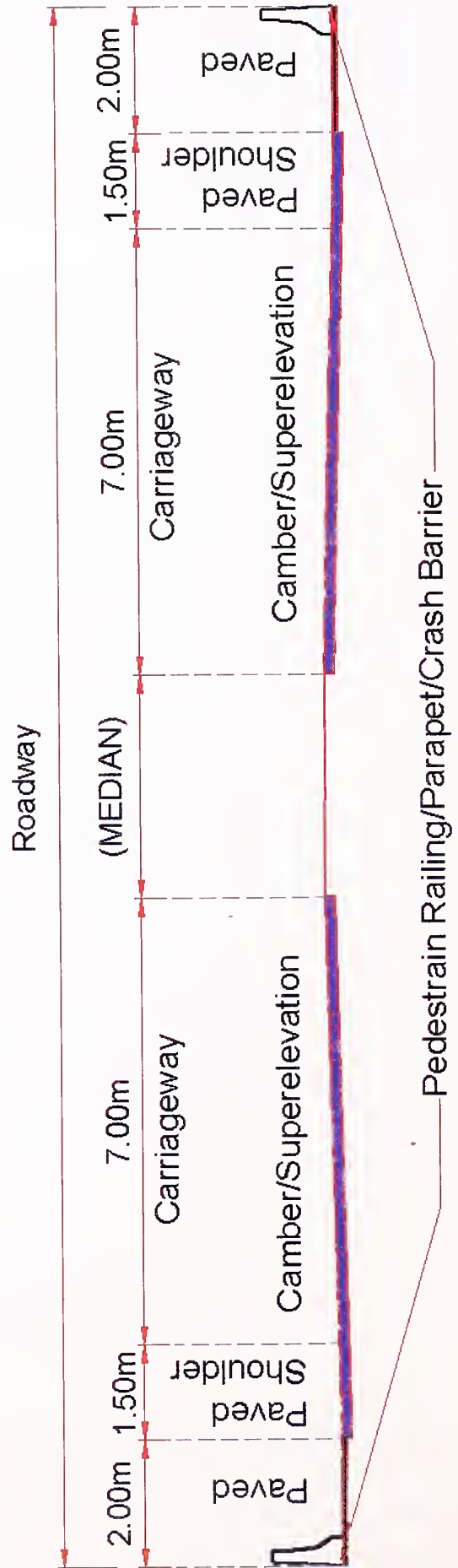

Fig. 7.1B : Cross Section of Slab/Box Culvert at Road Level  
4 Lane Divided Highway



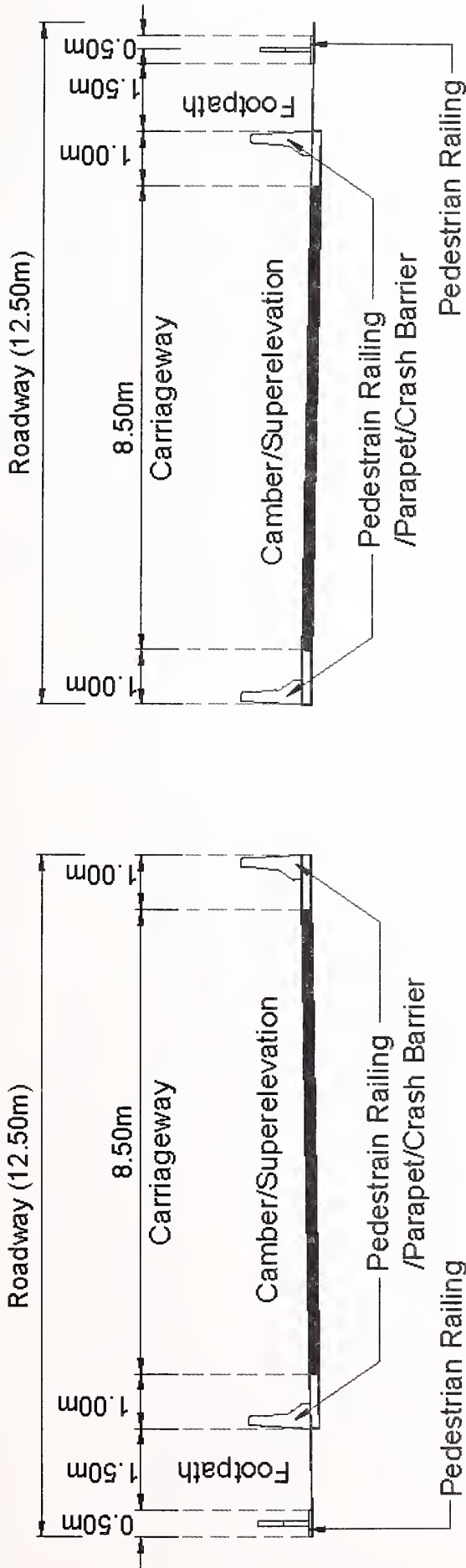

Fig. 7.2A : Cross Section of Bridge at Deck Level - with Footpath  
4 Lane Divided Highway

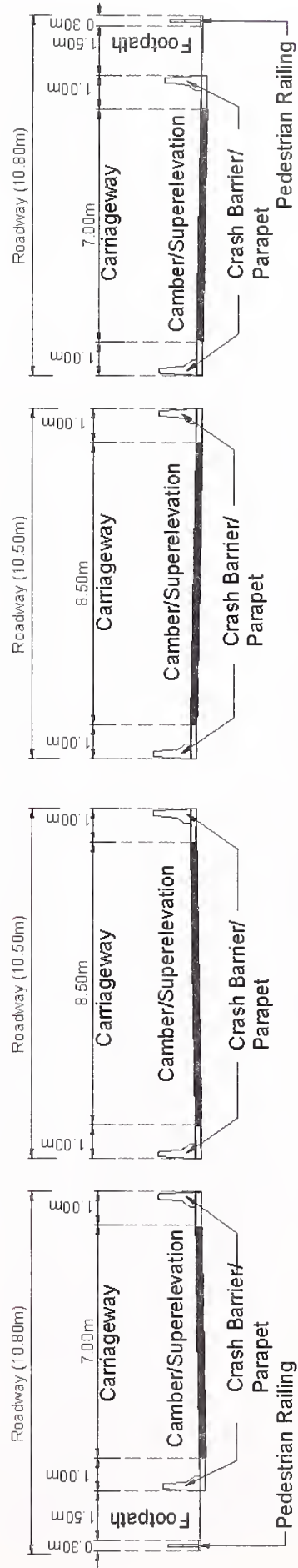

Fig. 7.2B : Cross Section of Bridge at Deck Level - with Service  
Road Bridges and Footpath

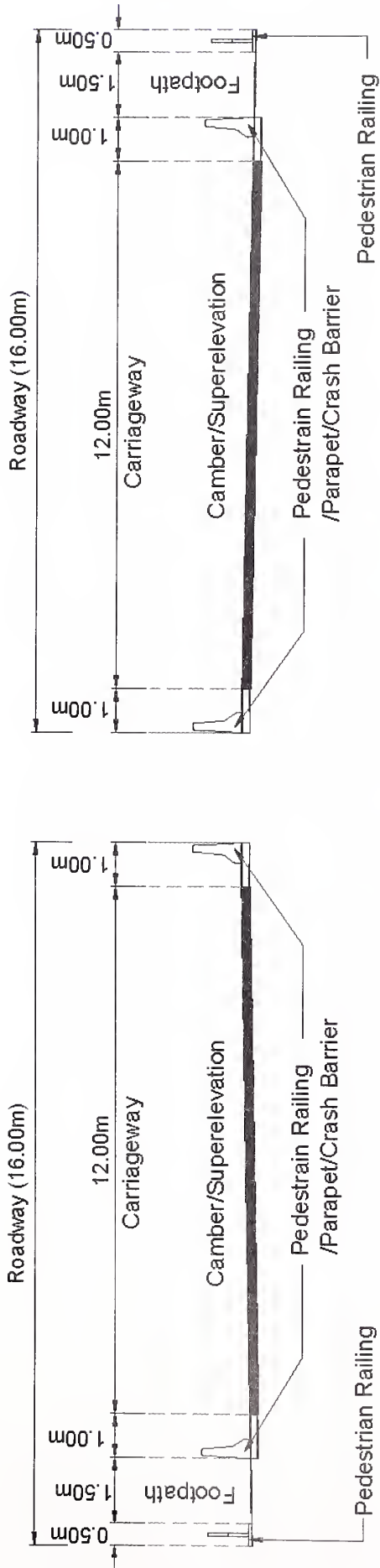

Fig. 7.3 : Cross Section of Bridge at Deck Level - with Footpath  
4 Lane Divided Highway (Both sides new Bridge for 6 - Lane Standards)

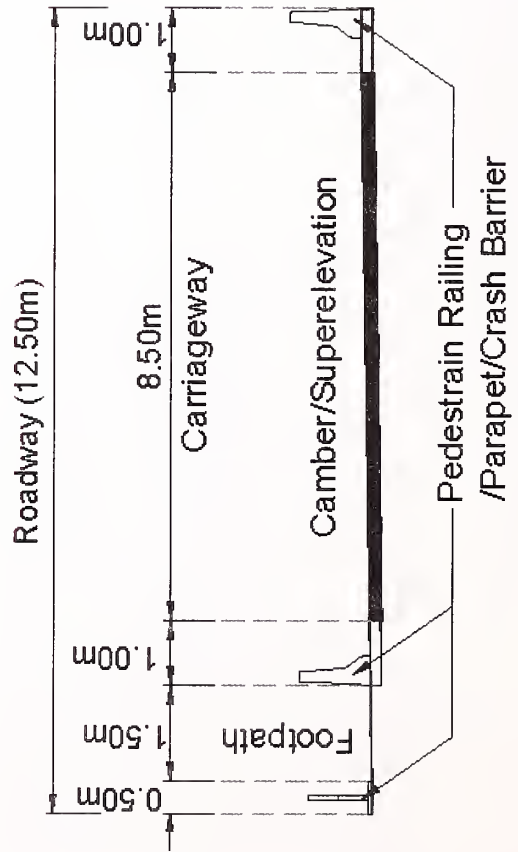

Fig. 7.4A : Cross Section of Bridge at Deck Level - with Footpath  
(T-Beam/Box Girder Type/Well/Pile Foundation)  
4 Lane Divided Highway (One side new Bridge and other sides Existing for 2-lane Bridge)

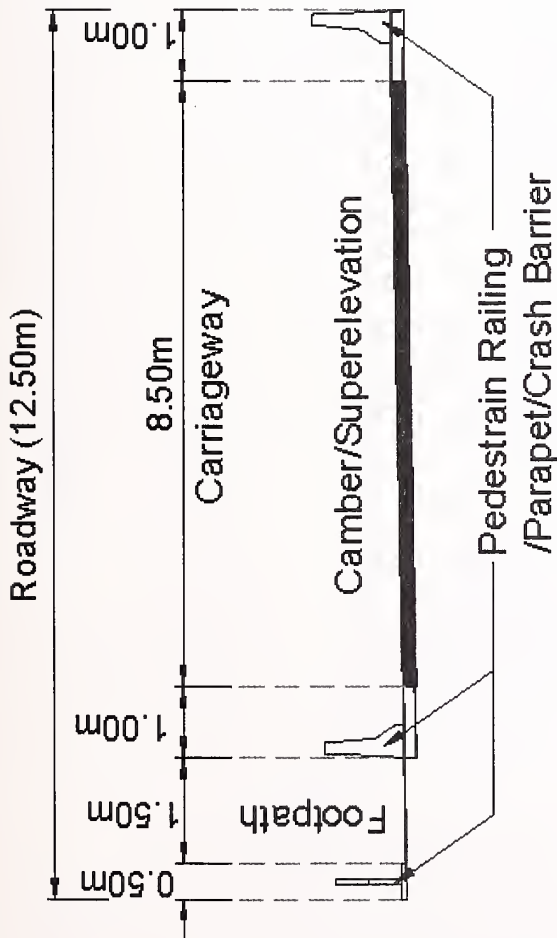
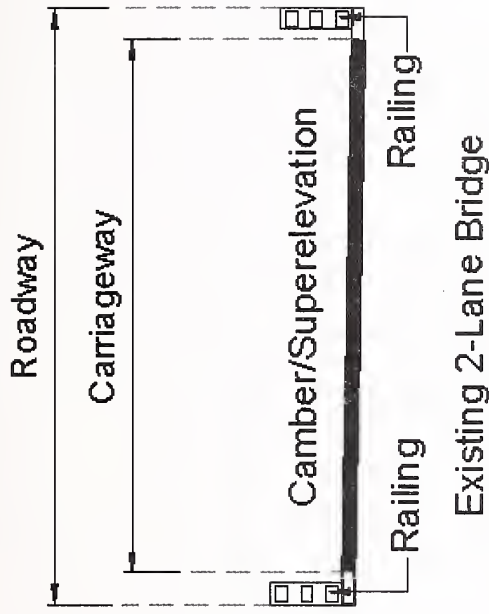
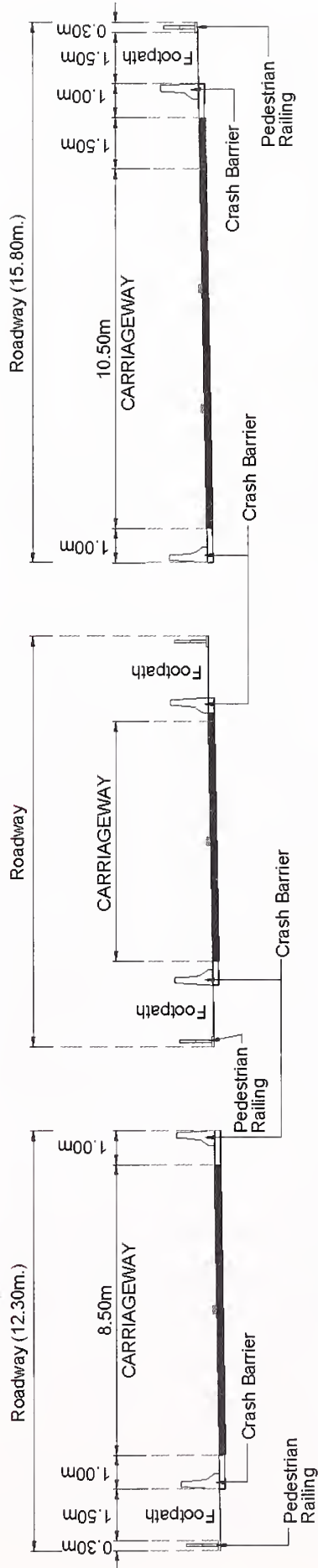

Fig. 7.4B : Cross Section of Bridge at Deck Level - without Footpath  
(T-Beam/Box Girder Type/Well/Pile Foundation)

4 Lane Divided Highway (One side new Bridge and other sides Existing for 2-Lane Bridge)



Existing 2-Lane Bridge



New Two Lane Bridge With one Side Footpath

Existing Bridge

New Three Lane Bridge With one Side Footpath

Fig. 7.5 : Cross Section of Bridge at Deck Level  
4 Lane Divided Highway (Bridges for 6 Lane Standard)  
Right Side new 3 Lane Bridge and Left Side Existing Two Lane Bridge with Footpath  
Plus new 2 Lane Bridge With Footpath on Left Side  
(NO SERVICE ROADS)

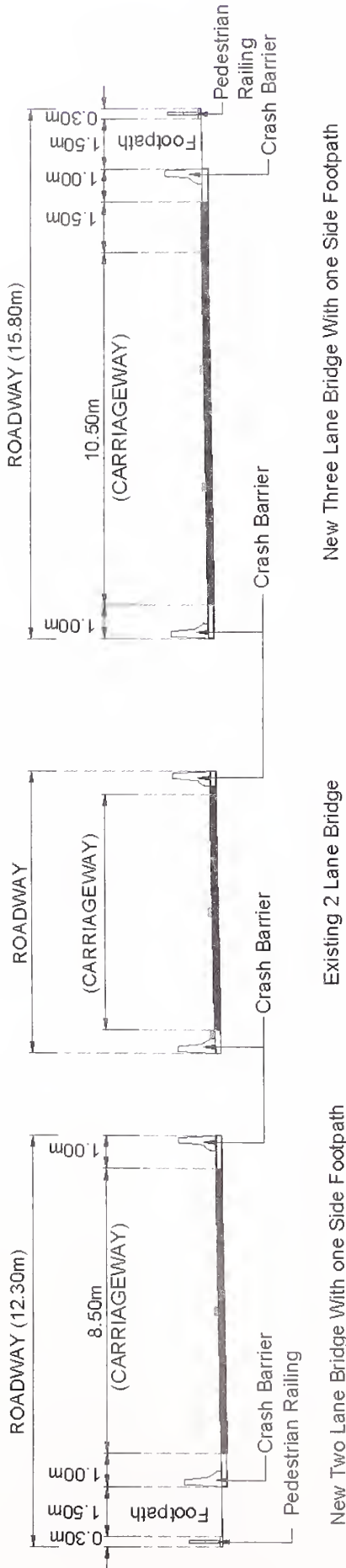

--- Pavement Marking

**Fig. 7.6 : Cross Section of Bridge at Deck Level  
4 Lane Divided Highway (Bridges for 6 Lane Standard)  
Right Side New 3 Lane Bridge and Left Side Existing Two Lane Bridge without Footpath  
Plus New 2 Lane Bridge With Footpath on Left Side  
(NO SERVICE ROADS)**

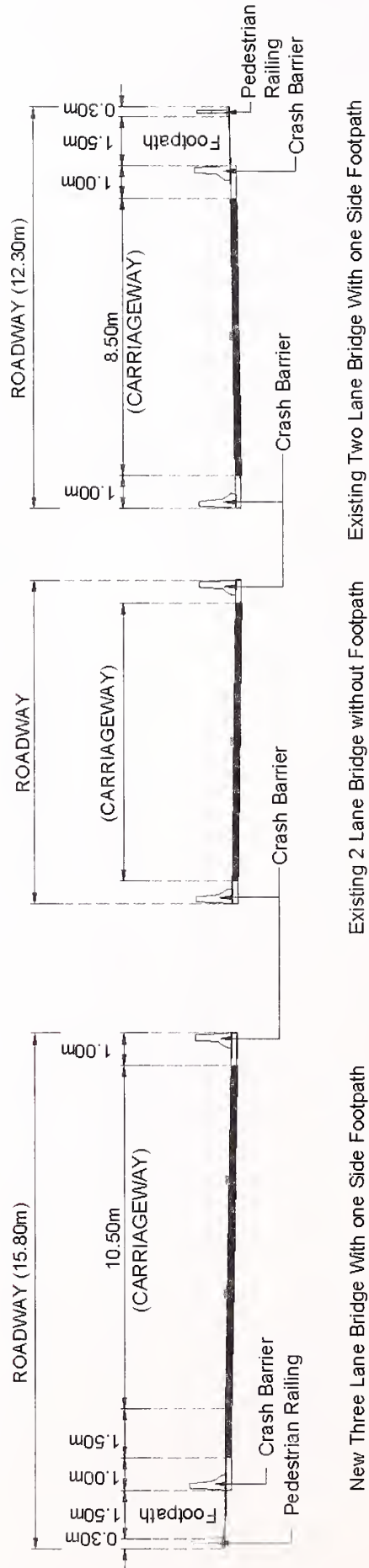

--- Pavement Marking

**Fig. 7.7 : Cross Section of Bridge at Deck Level  
4 Lane Divided Highway (Bridges for 6 Lane Standard)  
Right Side Existing 2 Lane Bridge with One Side Footpath plus  
New 3 Lane Bridge with One Side Footpath on LHS  
(NO SERVICE ROADS)**

- ii) The type and span arrangement may be such as to provide maximum riding comfort and involve minimum inspection and maintenance during the service life of structure.
- iii) Continuous superstructure with fewer number of bearings and expansion joints if not unsuitable otherwise should be preferred over simply supported spans.
- iv) For small bridges and culverts integral concept (in which sub-structures and superstructure are made joint less i.e. monolithic) is preferred.
- v) Wherever box girders are proposed for superstructure, the minimum clear depth inside the box shall be 1.50 m with suitable openings in the diaphragms and box to facilitate inspection. Haunches of minimum size of 300 mm (horizontal) and 150 mm (vertical) shall be provided at the extreme corners of the box section. Suitable arrangements for lighting shall be made to enable inspection of the box.
- vi) The following types of structures shall not be accepted.
  - a) Drop in spans with halved joints (articulations)
  - b) Trestle type frames for substructures
- vii) If constructions of structures like cable stayed suspension bridge or with special techniques is envisaged, it shall be specified in Schedule 'B' of the Concession Agreement. Similarly, in case minimum span length, spacing between joints, obligatory spans etc. are desired the same shall be specified in Schedule 'B'.
- viii) Concepts that involve precast elements are preferable for improved quality, better finish and reduction of environmental impact.
- ix) When the alignment crosses urban environment, the construction methodology should be such as to avoid prolonged disturbance to existing traffic.

## **7.5 Hydrology**

All the structures shall have adequate waterway, which shall in any case be not less than that of existing bridge (except when such waterways can be reduced in cases like clogging or silting of spans, etc.). The design discharge shall be evaluated for flood of 100 year return period.

## **7.6 Sub-Soil Investigations**

Independent sub-soil investigations shall be carried out to establish the soil parameters required for detailed design of foundations in accordance with relevant provisions of IRC:78 and MORTH Specifications.

## 7.7 Culverts and Bridges using Pipes

- i) Reinforced concrete pipes for culverts and bridge structures shall be of Non Pressure (NP) - 4 type conforming to the requirements of IS:458.
- ii) Minimum diameter of pipes for new pipe culverts shall be 1200 mm.
- iii) Existing culverts of diameter 900 mm and above, which are in sound condition and functioning satisfactorily, may be extended, using pipes of same diameter. All culverts having pipe diameter less than 900 mm shall be replaced with pipes of minimum 1200 mm diameter under both the carriageways. Minimum depth of earth cushion over pipe excluding road crust shall not be less than 600mm for new/reconstructed/retained culverts.

In case the cushion is insufficient, encasing of pipe in concrete shall be ensured. Floor protection shall be as specified in the relevant IRC Codes and Specifications.

## 7.8 Temporary Works

### 7.8.1 Form work

The Concessionaire shall be responsible for the safe, workable design and methodology for all temporary or permanent forms, staging and centering required for supporting and forming the concrete of shape, dimensions and surface finish as shown on the drawings (Refer IRC:87). Adequate foundation for the staging shall be ensured. Redundancy in support system shall also be ensured by providing diagonals and additional members. The following guidelines shall be adopted:

- i) Formwork shall be of steel, marine ply or laminated plywood.
- ii) Only such shuttering oil (release agent) shall be used, which permits easy removal of shutters without leaving stains or other marks on the surface of the concrete. Requirements given under Clause 3.5 of IRC:87 shall also be complied with.
- iii) In case of tubular staging of heights more than 10 m, special attention shall be paid to the structural adequacy of the system, efficacy of the connections (clamps etc), and foundations. Foundation blocks of adequate thickness in M15 cement concrete shall be provided under the base plates to prevent differential settlements. All bent tubular props shall be straightened before re-use and the member with deviation from straightness more than 1 in 600 of its length shall not be re-used. For re-used props, suitable reduction in the permissible loads shall be made depending upon their condition in accordance with recommendations of the manufacturer and as reviewed by the IE.
- iv) In case of pre-stressed concrete members, the side forms shall be removed as early as possible and the soffit forms shall permit movement of member without restraint; when pre-stress is applied. Form supports and forms for cast-in-situ members shall not be removed until sufficient pre-stress has been applied to carry all anticipated loads during construction stage.
- v) Adequate foundations for formwork shall be ensured.

### 7.8.2 *Special temporary and enabling works*

Designs, drawings and methodology proposed by the Concessionaire in the use of special temporary and enabling works like Launching Girders, Cantilever Construction Equipment, Tall Formwork, Shoring for Earth Retention, Lifting and Handling Equipments and the like shall be submitted to the Independent Engineer (IE) for his review and comments if any. The Concessionaire shall be fully responsible for the design and structural adequacy of all temporary and enabling works. Review by IE shall not relieve the Concessionaire of this responsibility.

**7.8.3** The construction methodology adopted by the Concessionaire should ensure speedy and safe construction including safety of workers.

## 7.9 **Foundations and Sub-Structures**

**7.9.1** The design of foundations and sub-structures shall conform to IRC:78.

### 7.9.2 *Open foundations*

The design of open foundations shall conform to IRC:78. Floor protection shall be provided as per Section 2500 of MORTH Specifications.

### 7.9.3 *Pile foundations*

- i) The design of pile foundations shall be done as per IRC:78. The Concessionaire shall submit a method statement supported by the following:-
  - a) Bore-log details for each foundation;
  - b) Design assumptions;
  - c) Design calculations both for single pile or group of piles and for pile type;
  - d) Type of piles-Bored cast-in-situ piles and driven piles;
  - e) Procedure adopted for installation of piles;
  - f) Arrangements for load testing of piles;
  - g) Format for reporting of test results.
- ii) The Concessionaire shall submit the following information regarding proposed proprietary system of piling:
  - a) General features of the process/system along with specifications and standards;
  - b) Authenticated copies of license/agreement. if any;
  - c) Details of plant and equipment to be used along with the names of manufacturers and name of process/system;
  - d) Details of projects where the process/system has been successfully used;

- e) Limitations, if any;
- f) Acceptance tests and criteria;
- g) Installation and maintenance procedure and schedule; and
- h) Performance warranty.

#### **7.9.4** *Well foundations*

- i) For conventional method of well sinking, the Concessionaire shall submit a method statement including the following:
  - a) Bore-log details for each foundation.
  - b) Design calculations and drawings,
  - c) Procedure for sinking and plugging of well,
  - d) Format for reporting of test results.
- ii) If proprietary system of well sinking like jack down method is proposed to be used, the Concessionaire shall submit relevant information covering inter-alia the following:
  - a) General features of the system along with specifications and standards and justification for the thickness of staining proposed to be adopted;
  - b) Authenticated copies of license/agreement, if any;
  - c) Details of plant and equipment to be used along with the names of manufacturers and name of process/system;
  - d) Details of projects where the process/system has been successfully used;
  - e) Limitations, if any;
  - f) Acceptance tests and criteria;
  - g) Installation and maintenance procedure and schedule; and
  - h) Performance warranty.
- iii) The Concessionaire in his methods statement shall include the procedure for sinking by special methods, carrying out tests, if any, of wells including design criteria/calculations, drawings and formats for reporting test results.

#### **7.10 Approach Slabs**

Approach slabs shall be provided for all bridges and grade separated structures as per Clause 217 of IRC:6 and Section 2700 of MORTH Specifications.

#### **7.11 Superstructures**

**7.11.1** The design of reinforced and pre-stressed concrete superstructures shall be as per IRC: 112 . The design of steel and steel-concrete composite super structures shall conform to IRC:24 and IRC:22 respectively.



**7.11.2** The Concessionaire shall submit method statement indicating inter-alia the following:

- i) Sources of materials,
- ii) Design, erection and removal of formwork,
- iii) Layout of casting yard together with necessary details,
- iv) Production, transportation, laying, compacting and curing of concrete,
- v) Sequence of concreting in cast-in-situ construction, side shifting of girders, if applicable and placing of girders on the bearings.
- vi) Details of construction joints
- vii) Pre-stressing system, if required,
- viii) Methodology and equipment for side shifting and launching of pre-cast girders,
- ix) Key personnel for execution and supervision,
- x) Testing and sampling procedure,
- xi) Equipment details.

## **7.12 Bearings**

**7.12.1** All bearings shall be easily accessible for inspection, maintenance and replacement. Suitable permanent arrangements shall be made for inspection of bearings from bridge deck. Design and specifications of bearings shall be as per IRC:83 (Part I, II and III). Spherical bearings shall conform to the requirements of BS:5400. The materials of bearings may however conform to the relevant SIS codes nearest to the specifications given in BS:5400. The drawing of bearings shall include the layout plan showing exact location on top of pier and abutment cap and the type of bearings i.e. fixed/free/rotational at each location along with notes for proper installation. The bearing should cater for movement in both longitudinal and lateral direction.

**7.12.2** The Concessionaire shall procure bearings only from the manufacturers approved by MORTH.

**7.12.3** The Concessionaire shall submit detailed specifications, designs and drawings including installation drawings and maintenance manual incorporating the replacement procedure.

**7.12.4** The Concessionaire shall obtain and submit a complete Quality Assurance Programme (QAP) from the manufacturer. The QAP shall give the full details of the process of quality control, raw material testing, various stages of manufacture, testing of bearing components as well as testing of complete bearing in conformity with relevant part of IRC:83, prior to the commencement of manufacture of the bearings.

**7.12.5** In addition to the routine testing of the materials and bearings at the manufacturer's premises, the Concessionaire shall arrange testing of random samples of one percent

(minimum one number of each type) of bearings from independent agency approved by the IE.

**7.12.6** The Concessionaire shall submit a certificate of confirmation regarding quality control measures taken during manufacture of the bearings and the material conforming to the prescribed standards and specifications. Full lot of bearings of the sample found to have inferior specifications to those certified by the manufacturer or to have major discrepancy in material specifications or which fail to meet the acceptance criteria, shall be rejected.

### **7.13 Expansion Joints**

- i) Structures shall have minimum number of expansion joints. This may be achieved by adopting longer spans, making the superstructure continuous or by adopting integrated structures. Expansion joints shall conform to IRC:SP: 69. The Concessionaire shall furnish guarantee/proprietary indemnity bonds from the manufacturers/suppliers of expansion joints for a period of 10 years.
- ii) For existing bridges all expansion joints, which are older than 15 years shall be replaced.
- iii) The Concessionaire shall procure expansion joints only from manufacturers approved by MORTH.
- iv) The expansion joints should cater for movement in both longitudinal and lateral direction.

### **7.14 Wearing Coat**

- i) The wearing coat may be either bituminous or cement concrete type. The wearing coat shall have unidirectional camber and shall be in conformity with Section 2700 of MORTH Specifications.
- ii) Wearing coat older than 15 years or in damaged/distressed condition shall be replaced.

### **7.15 Reinforced Earth Retaining Structures**

**7.15.1** Reinforced earth retaining structures should be given special attention in design, construction, ground improvement where necessary, maintenance and selection of System/ System design. Local and global stability of the structure shall be ensured. However, such structures shall not be provided near water bodies. The specification of RE structures shall conform to Section 3100 of MORTH Specifications.

**7.15.2** Design Accreditation and warranty for life of the structure from the approved supplier/manufacturer shall be obtained and furnished. A qualified and experienced technical representative of the approved supplier/manufacturer shall be present on site throughout during the casting and erection phases to ensure that the quality of the works executed by the Concessionaire is in accordance with good industry practice.

**7.15.3** The Concessionaire shall submit relevant information on the system covering inter-alia the following:

- i) General features of the system along with specifications and standards;
- ii) Authenticated copies of license/agreement, if any;
- iii) Details of plant and equipment to be used along with the names of manufacturers and name of process/system;
- iv) Details of projects where the process/system has been successfully used;
- v) Limitations, if any;
- vi) Acceptance tests and criteria;
- vii) Installation and maintenance procedure and schedule; and
- viii) Performance warranty.

**7.15.4** The Concessionaire shall submit a method statement including the following :

- i) Design assumptions calculations and drawings,
- ii) Construction Procedure,
- iii) Tests to be conducted including frequency and the formats for reporting the test results.

**7.15.5** The packaging of reinforcing elements shall clearly indicate the name of the manufacturer/supplier and brand name, date of production, expiry, if any and batch identification number along with the manufacturers test certificates.

## **7.16 River Training and Protective Works**

River training and protective works shall be provided wherever required for ensuring the safety of bridges and their approaches on either side. The design of various types of river training and protective works shall be in accordance with IRC:89. The construction of river training works shall conform to MORTH Specifications.

## **7.17 Safety Barriers**

- i) For bridges without foot paths, concrete crash barriers shall be provided at the edge of the carriageway on all new bridges.
- ii) The type design for the crash barriers may be adopted as per IRC:5. The design loading for the crash barriers shall be as per Clause 209.7 of IRC:6.
- iii) For bridges with foot paths, pedestrian railing shall be provided on the outer side of footpath.
- iv) The railings of existing bridges shall be replaced by crash barriers, where specified in Schedule 'B' of the Concession Agreement.
- v) Parapets/Railings of the existing bridges/culverts to be repaired/replaced shall be specified in Schedule 'B' of the Concession Agreement.

## **7.18 Rail-Road Bridges**

**7.18.1** ROB/RUB to be provided shall be as specified in this Manual, with particular reference to the provisions of Para 7.3 of this Section. Any deviation to these provisions shall be specified in Schedule 'D'.

### **7.18.2** *Road over bridge (road over rail)*

- i) In case a 2-lane bridge exists over the railway tracks, another two-lane bridge shall be constructed for one side traffic. The treatment to existing structure shall be given as in Sub Para 7.3 (iv) of this Section.
- ii) In case the bridge is to be provided over an existing level crossing, twin 2-lane bridges shall be constructed with overall width as given in Sub Para 7.3 (ii) of this Section. If the alignment of road at the existing railway crossing has skew angle more than 45 degrees, the alignment of road or of pier/abutment shall be suitably designed to reduce skew angle up to 45 degrees.
- iii) The horizontal and vertical clearances to be provided shall be as per requirement of the Railway authorities.
- iv) The Concessionaire shall be required to obtain approvals of all designs and drawings from the concerned Railway authorities.
- v) The construction of ROB within the railway boundary shall be under the supervision of Railway authorities.
- vi) The approach gradient shall not be steeper than 1 in 40.

### **7.18.3** *Road under bridges (road under railway line)*

- i) Full roadway width as in the approaches shall pass below the bridge structure allowing for widening of Project Highway to 6-lane at a later date. The service roads where provided shall be continued in the bridge portion also.
- ii) The vertical and lateral clearances shall be as per guidelines given in Section 2 of this Manual.
- iii) These structures shall be designed to carry railway loads. The Concessionaire shall be required to obtain approvals of all designs and drawings from the concerned Railway authorities. The design of structure shall be in accordance with relevant Railway codes.
- iv) The construction of RUB and its approaches shall be carried out in conformity with the terms specified in the approval granted by the Railway authorities.

**7.18.4** In cases of ROB, the service road on both the sides shall be joined through one of the viaducts of ROB. This arrangement shall be on either side of the railway crossing if the situation demands. For some proportion of service road traffic, safe entry and exit shall be provided from service roads to the ROB.

### 7.19 Grade Separated Road Structures

- i) The location, type and length of grade separated structures to be provided on the Project Highway shall be as specified in Schedule 'B' of the Concession Agreement.
- ii) The vertical and lateral clearances shall be as per requirements given in Section 2 of this Manual. Design of structures shall conform to requirements specified in this Manual.

A typical cross section of a grade separated structure/elevated sections is given in **Fig. 7.8**.

### 7.20 Drainage

An effective drainage system for the bridge deck shall be planned, designed and installed so as to ensure that water from the deck is taken down to ground level/drainage courses by adequate size of drainage spouts and pipes.

### 7.21 Structures in Marine Environment

Necessary measures/treatments for protecting structures in marine environment shall be as specified in Schedule 'B' of the Concession Agreement.

### 7.22 Repairs and Strengthening

- i) Structures requiring repairs and strengthening shall be specified in Schedule 'B' of the Concession Agreement. This shall be based on detailed condition survey of existing structures and shall bring out the nature and extent of repairs to be carried out, covering the following in addition to other specific requirements:-
  - a) Repair/replacement of damaged railings and parapets, provision of crash barriers,
  - b) Replacement of wearing coat (old wearing coat shall be removed and replaced by bituminous wearing coat),
  - c) Replacement of expansion joints,
  - d) Replacement of bearings,
  - e) Structural repairs to sub-structure/super structure, including replacement of substructure/superstructure if required
  - f) Repair to flooring and protection works.
- ii) The Concessionaire shall submit repairs and strengthening plan for structures in para (i) above to the Independent Engineer for review and comments, if any. For all other structures with minor deficiencies, not affecting structural inadequacies and integrity, appropriate repair measures may be proposed and submitted to the Independent Engineer for review and comments, if any.

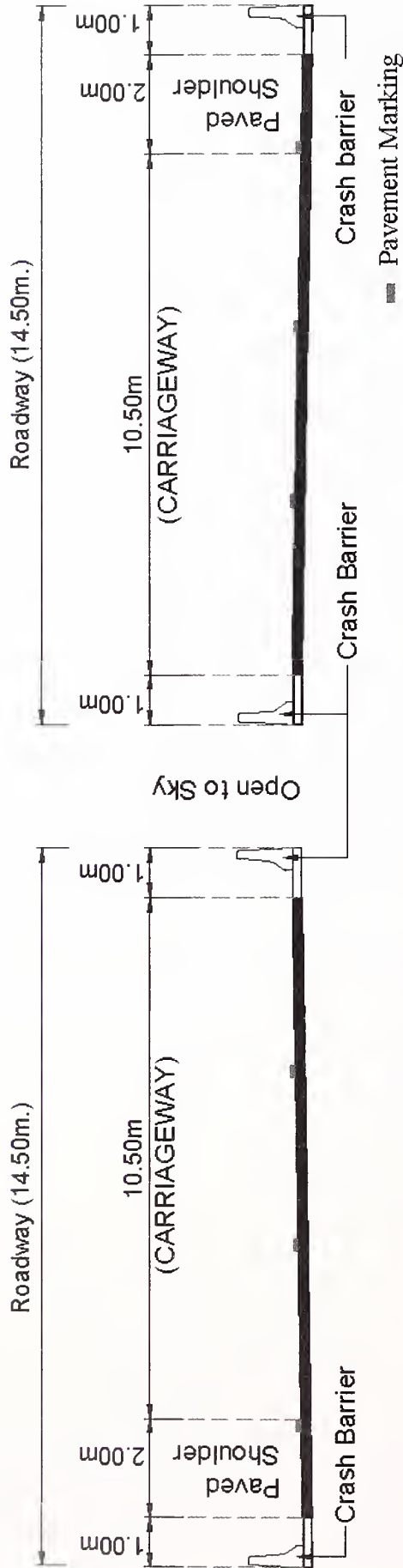

Fig. 7.8 : Cross Section of Grade Separated Structure  
Vehicular/ Pedestrian/ Cattle Underpass; and Elevated Section  
6 - LANE DIVIDED HIGHWAY

- iii) Strengthening/rehabilitation work shall be carried out in accordance with relevant IRC Codes and Guidelines.
- iv) The Concessionaire shall take up repair and widening of existing bridge at a particular site only after the new bridge at that site is constructed and the same can be used by the traffic. Before taking up the works of repair and widening of the existing bridge, the Concessionaire shall make all arrangements to ensure that both way traffic can use the new bridge and smooth flow of traffic is maintained. The Concessionaire shall take all precautions to guard against any traffic accident due to such diversion and shall use all necessary road signs, traffic management measures etc. for the purpose. After completion of repair and widening of the existing bridge, all arrangements shall be made so that both the old and the new bridges at the site can be used by the traffic. Repair works for substructure, foundation, and abutment etc., which will not affect or disturb the flow of traffic over the existing bridges, may, however, be taken up before completion of the new bridge. In such cases where new 2-lane bridges is not required to be constructed before COD, the existing bridge shall be repaired/strengthened by suitably regulating the traffic on the bridge or by temporary diversion.

### **7.23 Design Report**

The Concessionaire shall furnish the design report including the following to the Independent Engineer for his review and comments, if any.

- i) Sub soil exploration report as per IRC:78 as specified in Para 7.6 above.
- ii) Hydrological investigation report including design discharge calculation for the bridges, in case of any change in the proposed waterway of any bridge as specified in Para 7.5 above.
- iii) Designs and drawings of temporary works, foundations, substructures and superstructure of structures
- iv) Detailed report regarding the bridges whose width is less than the roadway width and the proposal for their improvement.

Any other information relevant to the design report.

### **7.24 Responsibility for Design and Structural Adequacy**

The Concessionaire shall be fully responsible for the design, structural adequacy and detailing of bridge and culvert structures. Review by IE shall not relieve the Concessionaire of this responsibility.

## SECTION - 8

### MATERIALS

#### 8.1 General

All materials to be used in works shall be in conformity with the requirements laid down for relevant item in MORTH Specifications. If the Concessionaire proposes to use any material, which is not covered in MORTH Specifications, it shall conform to IRC or relevant Indian Standards, if there are any, or to the International Standards. Proprietary products proposed to be used shall be proven by use in comparable international road and bridge projects, and shall be supported with authenticated licensing arrangement with the manufacturer.

---



## SECTION – 9

### TRAFFIC CONTROL DEVICES/ROAD SAFETY DEVICES/ ROAD SIDE FURNITURE

#### 9.1 General

The multi-lane highways being built under various road development programmes are adopting the geometric standards specifications, signage, road markings etc. as per the provisions contained in the codes of practice and the standards of the Indian Roads Congress supported by the Ministry's specifications. However, accident data demonstrates that motorists leave the roadway for numerous reasons including errors of judgment. To ensure long term road safety on these highways, the following suitable engineering measure are considered essential for adoption so as to help in improving road safety leading to reduction of accidents.

Traffic Control Devices, Road Safety Devices and Road Side Furniture shall comprise of road signs, road markings, object markers, hazard markers, studs, delineators, attenuators, safety barriers, pedestrian guard rails, boundary stones, km stones, etc. Guidelines given in IRC:8, IRC:25, IRC:26, IRC:35, IRC:67, IRC:79, IRC:103 and Section 800 of MORTH Specifications shall be used for providing these items unless otherwise specified in this Section.

#### 9.2 Road Signs

The three types of road signs *viz.*, mandatory/regulatory signs, cautionary/warning signs and informatory signs shall be provided as given in IRC:67 and Section 800 of MORTH Specifications. Proper signs shall be provided for main carriageways, service and slip roads, toll plaza and other project highway facilities. Clustering and proliferation of road signs shall be avoided for enhancing their effectiveness.

**9.2.1** There shall be corresponding road markings with stop signs, give way signs, merging or diverging traffic signs, lane closed signs, road narrowing signs, slip roads/diversion signs, compulsory keep left/right signs, or any other signs as per IRC:67.

**9.2.2** The Specifications and Standards of road signs, which are not covered by IRC:67 would be as per International Standards.

**9.2.3** All road signs shall be of Prismatic Grade Sheeting corresponding to Class C Sheeting described in IRC:67 and any of the sheeting types VIII, IX or XI as per ASTM D 4956-09 fixed over Aluminum or Aluminum Composite Material. The sheeting for different type of signs can be chosen based on the selection guidance provided in IRC:67 depending upon the situation encountered by road users in viewing the signs. Sheeting with high coefficient of retro reflection at small observation angle are for a road sign to be viewed by a driver from a long distance, whereas the sheeting with wide observation angle for better performance at short distance viewing. The Type XI sheeting will have better performance at short and medium distances. Micro prismatic sheeting is preferred for gantry mounted overhead signs. Type IV micro prismatic sheeting can be used for delineator posts.

**9.2.4** Shoulder mounted signs shall be supported on GI pipes. Overhead signs shall be placed on a structurally sound gantry or cantilever structure made of GI pipes. Its height, lateral and vertical clearance for installation shall be as per the guidance provided in IRC:67 and also as per MORTH Specifications.

**9.2.5** Locations of overhead traffic signs shall be specified in Schedule 'C' of the Concession Agreement. The following conditions may be considered while deciding about the locations of overhead signs:

- i) Present and future traffic volume.
- ii) Restricted sight distance.
- iii) Built-up stretches.
- iv) Insufficient space for placing ground mounted signs and also where road features and roadside activities obscure the ground mounted signs.
- v) Distances of important places and routes at suitable intervals.
- vi) Before major intersections of considerable traffic bifurcation and on approaches to interchanges/flyovers/VUPs.

The overall size of gantry mounted signs shall be evolved based on design of sign boards given in IRC:67.

**9.2.6** The road sign, traffic signal or any other device erected for traffic control, traffic guidance and or traffic information shall not obscure other traffic sign. Further, the signs and signals shall not carry any advertisement.

**9.2.7** Wherever the Project Highway alignment is on a curve, there shall be advance cautionary signs for sharp curves (depending on whether it is on left or right) and chevron signs (rectangular in shape with yellow background and black arrow) at the outer edge of the curve. The sign for the curve ahead particularly in mountainous and steep terrain shall always be accompanied with chevron signs at the outer edge of the curve and appropriate delineation. Following guidance shall be adopted while installing curve signs:

- i) The curves with radii upto 450 m shall be provided with curves warning sign in advance of hazard and single Chevrons on outer edge of curve. Chevron signs shall be always placed on outer edge of the curve and spaced uniformly for the length covering transition length and the straight portion as given in IRC:67. Due to any reason if there is any curve with radius less than 450 m, the safe negotiating speed for the particular curve shall be placed along with curve warning sign at both approaches. Generally if the difference between the approach speed and permissible negotiating speed of any curve is more than 15 kmph, the curve warning and speed limit sign shall be placed on shoulder side and median side also.
- ii) The curves with radii 451 m to 750 m shall be installed with single Chevrons on outer edge of curve at 75 m spacing
- iii) The curves with radii 751 m to 1200 m with deflection angle greater than 20 degree shall be provided with single Chevron signs

- iv) For curves with radii 751 m to 1200 m with deflection angle less than 20 degree and also curves with radii from 1201 to 2000 m shall be provided with forgiving type delineator posts at 40 m spacing on outer edge of curves. **Fig. 9.1** presents the positioning of Chevron signs and also the Object Hazard Markers with respect to traffic movement.

**9.2.8** Each exit ramp/slip road shall have ground mounted flag type direction sign indicating the name of the place and the important roads it would lead to.

#### **9.2.9** *Direction information sign*

Gantry and shoulder mounted Advance Direction Sign shall be provided in advance of an interchange/ Flyover/ VUP or any urban reach. Flag type direction information sign shall be installed at the start of deceleration length or gorge indicating the destinations of the side roads. **Fig. 9.2** gives the typical placement of direction information signs.

#### **9.2.10** *Signs for At-grade junctions*

Stack type advance direction sign and flag type direction signs shall be provided for at-grade junctions. The junction control shall be established either with STOP sign or GIVEWAY sign based on visibility funnel given in IRC:67. STOP and GIVEWAY sign shall not be installed on Project Highway, but shall be always on side road only. The tip of all splitter and triangular islands shall be installed with the direction regulatory sign of appropriate size along with Object Hazard Markers. Though both signs can be installed in one post, but while installing them the minimum clearance between vertical faces of signs and kerb specified in IRC:67 shall be ensured

**9.2.11** The approach arm to roundabout shall be provided with GIVEWAY sign and central island with turn left sign and double chevron signs as given in IRC:67. Relatively insignificant minor road approaches shall be provided with STOP sign and also a speed breaker at 8 m to 12 m away from edge line, whereas a side road warning sign shall be placed on Project Highway. The design details of a speed breaker which can be considered for side road or on service roads are given in **Fig. 9.3**.

#### **9.2.12** *Facility information*

Roadside facility information sign shall be provided wherever necessary like for Eating place, Filling station, Police station and Hospitals

#### **9.2.13** *Prohibitory signs*

Required prohibitory sign shall be placed prohibiting the entry of certain movements like Bullocks carts into Project Highway and also parking prohibitory sign in junction influence area of Project Highway.

#### **9.2.14** *Pedestrian signs*

Pedestrians guide rails shall be provided to streamline them into safe zebra crossing locations. Pedestrian guard rail shall be forgiving type. The zebra crossing shall be provided with warning sign and also informatory sign. On approach to school, warning sign shall be provided and zone shall be provided with footways and speed limit sign.

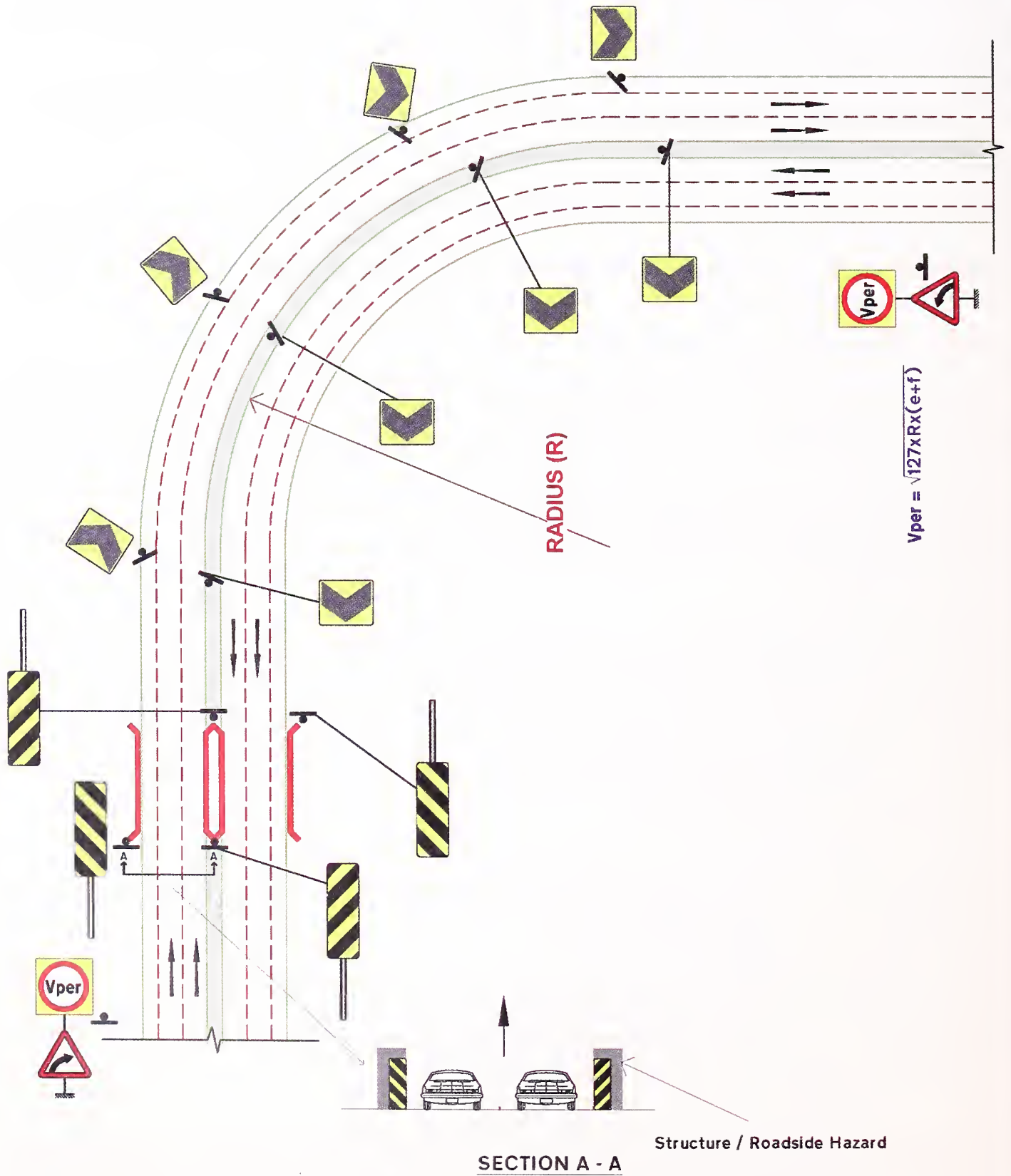

Fig. 9.1 Curve Delineation in a Divided Carriageway

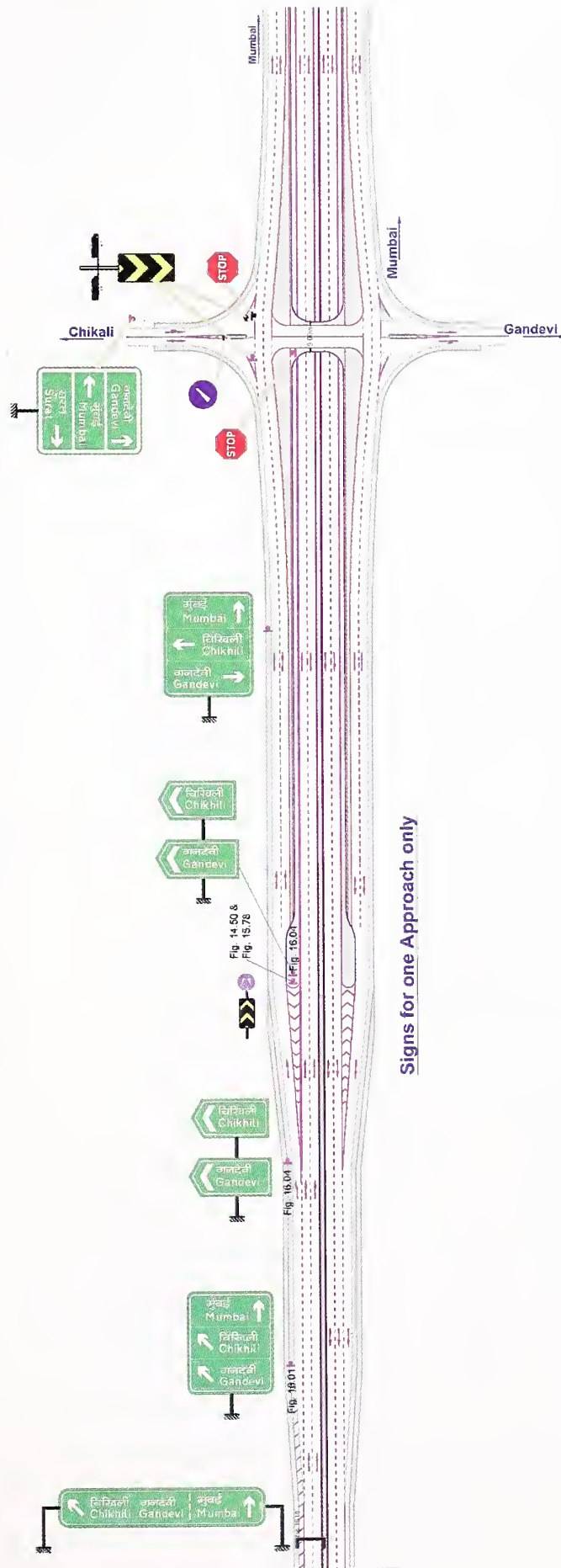

Fig. 9.2 Sign Plan for a Flyover/MUP Approach

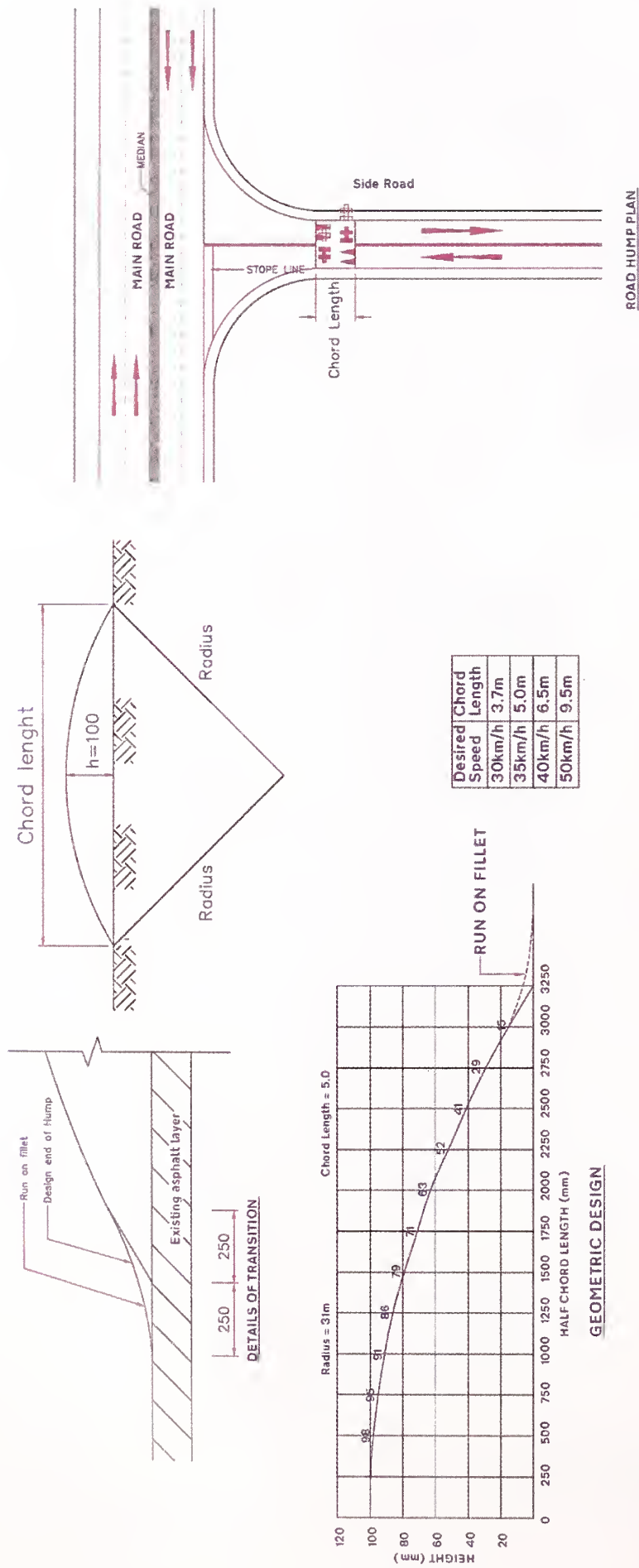

Fig 9.03:- Design Details of Speed Breaker

Fig. 9.3 Design Details of Speed Breaker

Generally grade separated pedestrians crossing facility shall be provided. On exceptional situations, at-grade crossing can be provided with adequate warning signs. The typical application is shown in **Fig. 9.4** and which also gives the safety measure to create gateway effect when the project highway passes through a settlement.

### **9.3 Road Markings**

Road markings shall be of hot applied thermoplastic materials with glass reflectorizing beads as per relevant specifications. The quality of thermoplastic application shall be ensured by testing actual samples by random selection during application time to avoid any possible deception in the quality of materials used. Since the readability of Project Highway hinges on road markings, the minimum performance level indicated in relevant code and specification for road marking shall be ensured and any shortage shall invite reapplication of road marking.

#### **9.3.1 Longitudinal markings**

All curves upto 750 m radii shall be provided with traffic lane line marking meant for curves sections i.e. with shorter interval as per IRC:35. Flyover and VUPs/PUPs and their approaches of 300 m be provided with traffic lane line marking meant for intersections. The traffic lane line shall be continues for curves having radii less than 450 m, where general operating speed is 100 kmph.

**9.3.2** In order to ensure the conspicuity of road markings, median side edge line shall be placed at least 350 mm from the vertical face of kerb

#### **9.3.3 Diagonal and chevron markings**

Chevron marking shall be provided for all entry/exit and shall be in continuation of shoulder edge line. Diagonal marking shall be provided in case of opposite stream of traffic.

#### **9.3.4 Bus and truck lane marking**

Bus and truck lane marking shall be provided with adequate chevron marking at diverging/merging locations with main carriageway. The continuity of shoulder edge line shall be maintained while making chevron markings.

#### **9.3.5 Stop line and give way marking**

Stop line and Give way marking shall be provided for side road, which shall also be in the continuity of shoulder side edge line

#### **9.3.6 Longitudinal marking to toll booths**

The traffic lane marking running through the four lane shall be continued till the toll booth, in such a way that traffic from each lane of project highway is guided to discharge uniformly to different toll booths. Toll booth shall be provided with chevron marking and hazard markers. There shall be transverse bar marking to alert the traffic about the approaching toll booth.

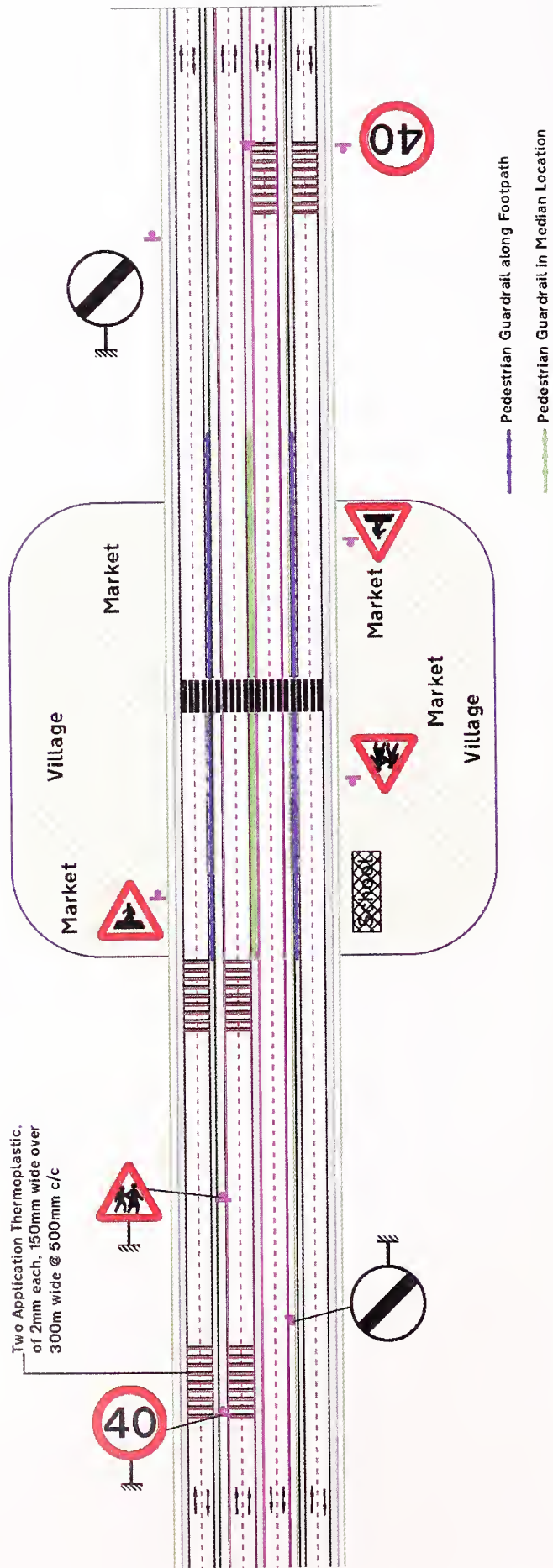

Fig. 9.4 Safety Measures on Project Highway passes through Ribbon Development



### 9.3.7 *Object markings*

To streamline the traffic through the defined pathway and also to discourage zigzag vehicular movements, the paved surfaced between edge line and the adjacent raised islands/ separators/barriers shall be provided with diagonal markings. Typical applications would come in junctions and in truck/ bus lay-bye, where the diagonal markings along with carriageway edge line would enable the driver to notice the raised hazards. The shoulder and median edge line shall be continuous through and through and shall be broken lines where vehicles are allowed to cross like in continuity line. **Fig. 9.5** gives a cross sectional view for lateral placement of pavement markings.

## 9.4 **Road Delineators**

These are roadway Indicators, hazard markers and object markers as given in IRC:79.

### 9.4.1 *Roadway indicators*

Circular Iron Posts of 1.0 m height or concrete or any manufactures product with retro-reflective reflector of at least Type IV sheeting as per criteria, placement and spacing given in IRC:79 shall be provided. This will include low embankments and flat curves where crash barriers are not provided.

**9.4.2** Hazard Markers shall be provided as given IRC:67. In addition, the objects close to the road shall be painted with black and yellow stripes using the paint conforming to IS:164.

**9.4.3** Object Markers shall be provided as given in IRC:79 and IRC:67. All physical objects projects above the Finished Road Level (FRL) that are falling within 3 m from the carriageway edge line shall be illuminated with Object Hazard Markers (OHM). The objects shall include foot path or utility poles or parapet or concrete barrier of Major bridge, Minor bridge, Culverts, RE wall start of Underpass or flyovers. The Object Hazard Marker shall be either left OHM or right OHM or Two way Hazard Marker with respect to position of object to the traffic as shown in **Fig. 9.1**. In addition the kerbs in the medians/traffic islands shall be painted with black and white stripes (black and yellow stripes at hazardous locations) using the paint conforming to IS:164.

## 9.5 **Reflective Pavement Markers (Road Studs)**

The Reflective Pavement Markers(RRPM) i.e. road studs shall be provided to improve the visibility in night time and wet weather conditions. These shall be prismatic retro-reflective type conforming to ASTM D 4280. RRPM shall be provided on curves and approaches, bridges and approaches and junction influence. The RRPM on shoulder edge line shall be Red in colour and that on median edge line shall be Amber colour. RRPM shall be provided for traffic lane for all curves less than 400 m radii and shall be white in colour. The RRPM on traffic lane line shall be placed at the centre of gap of lane line marking. The RRPM shall be provided for pedestrian crossing to make them visible and shall be red colour. The details of road studs are provided in **Table 9.1**.

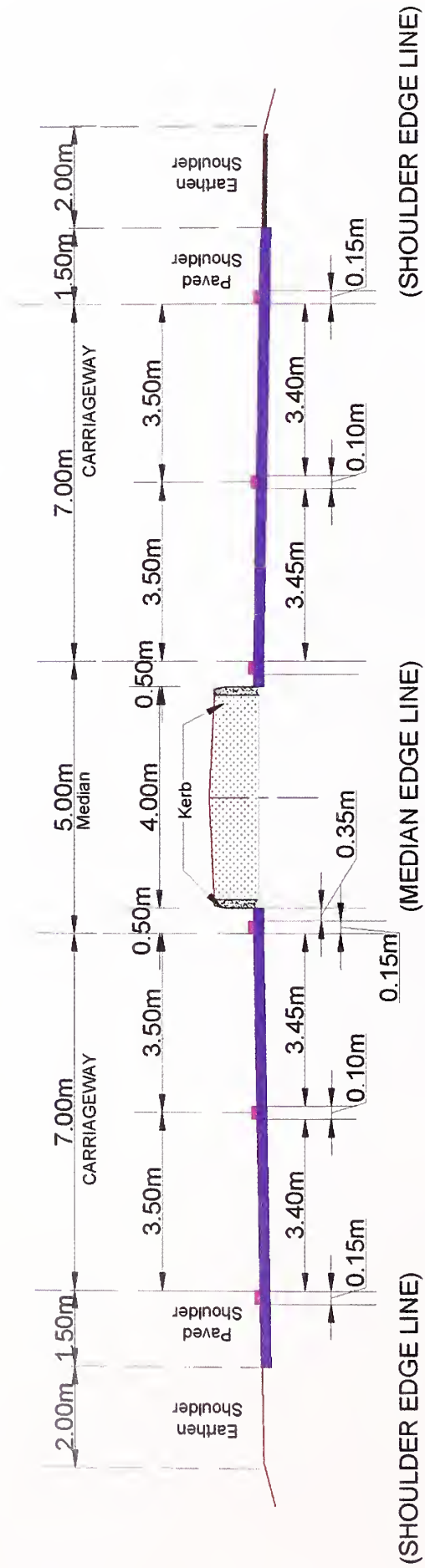

■ Pavement Marking

New 4-Lane Construction

Fig. 9.5 Placement of Markings (Cross-Sectional View)

Table 9.1 Warrants for Road Studs

Sl. No.	Description of section		Length	Spacing	Location & Colour
1)	All sections of Project Highway having horizontal curves	Curve radii upto 450	Curve length including transition with 20 m on either side.	9 m	For shoulder and median side edge lines. (Red colour on shoulder side and Amber colour for median side)
2)		Curve radii 451 to 750		18 m	
3)		Curve radii 751 to 2000 m and critical section		27 m	
4)	All sections of Project Highway having horizontal curves	Length of highway where vertical gradient is 2.5% and above and its Vertical curves	Length including vertical grade and curves and adjoining 180 m portion on either side	18 m	
5)	All sections of Project Highway where overtaking prohibited	Sections where overtaking prohibited	Length of no overtaking zone.	18 m	For shoulder and median side edge lines and traffic lane line. (Red colour on shoulder side, Amber colour for median side and white colour for traffic lane line)
6)	All Major/Minor Bridge, ROB and all structures (Interchange/Flyover/VUP)	Structure	Structure portion and adjoining 180 m on either side	9 m	For shoulder and median side edge lines. (Red colour on shoulder side and Amber colour for median side)
7)		Approaches	Approach length including the length of acceleration/ deceleration length if any and 180m adjoining on either side.	18 m	
8)		Built-up areas	Built-up area/ settlement/ villages	Length of built up from the start to end	

Sl. No.	Description of section		Length	Spacing	Location & Colour
9)	All entry/exit slip roads/ramps and its acceleration/ deceleration lanes	Entry/exit slip roads and ramps	Length of both side edge lines of slip roads/ramp+edge line of acceleration/ deceleration lane	9 m	Red colour on edge lines
10)			Chevron/diagonal markings on gorge	6 m	Red Colour for Chevrons/diagonal markings
11)		Continuity line for acceleration/ deceleration lane for entry/ exit of slip	Length of crossable continuity line for lane changing of entry/exit slip roads	8 m	Green Colour for crossable continuity line
12)	All junctions and median openings	Storage lane and acceleration/ deceleration lanes including 180m on either side	Length of Shoulder and median edge lines	18 m	Red colour on Shoulder side and Amber Colour for median sides
13)			Chevron/diagonal markings	6 m	Red Colour for Chevrons/diagonal markings
14)		Across the carriageway	At the start of acceleration lane	3 rows at 1m apart	Green Color
15)	Pedestrian Crossing	For zebra crossing marking	At four corners of all block of Zebra crossing markings	2 rows & at 0.5 m spacing	Amber Color

Alternatively, Solar Powered Road Markers are more effective and draw attention of drivers and shall be provided at locations like at Sl. 6 & 8 and also other locations where performance of normal road studs are not that effective due to street lightings and other roadside activities.

### 9.6 Traffic Impact Attenuators

Attenuators shall be provided at hazardous locations and gorge areas so as to act as energy absorber. The attenuators or crash cushions shall be composed of W-beam fender panels supported by diaphragm with trigger mechanism or composed of sand barrels as per Clause 814 the MORTH Specifications and the contractor/supplier shall furnish the certificate that the system to be installed has been tested in accordance with the NCHRP 350 and performs effectively at design speeds up to 100 kmph. The space requirement to shield a fixed object should be considered while designing and constructing the attenuators. **Fig. 9.6** shows the area that should be made available for crash attenuators installations The design

**MINIMUM SPACE REQUIRED FOR CRASH ATTENUATORS.**  
I.e. RESERVE AREA (In meter)

SPEED OF MAIN HIGHWAY (kmph)	MINIMUM SPACE						PREFERRED SPACE		
	RESTRICTED CONDITIONS			UNRESTRICTED CONDITIONS					
	N	L	F	N	L	F			
50	2	2.5	0.5	2.5	3.5	1	3.5	5	1.5
80	2	5	0.5	2.5	7.5	1	3.5	10	1.5
100	2	8.5	0.5	2.5	13.5	1	3.5	17	1.5
120	2	11	0.5	2.5	17	1	3.5	2.1	1.5

**THE AREA IN WHICH CRASH ATTENUATOR TO BE ACCOMODATED**

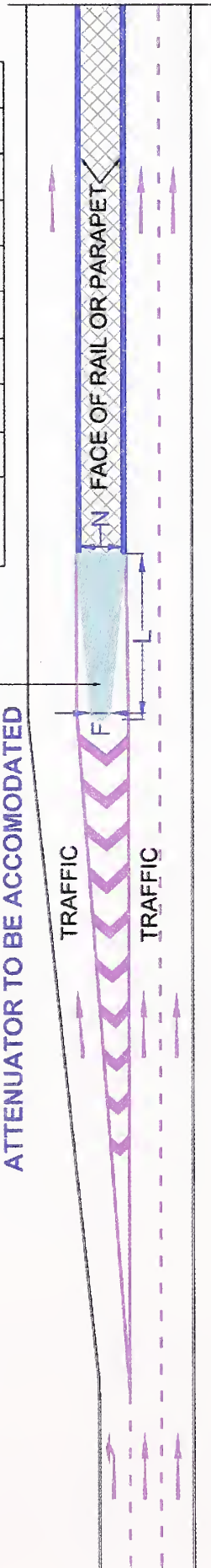

**Fig. 9.6 Space Required to Place Crash Attenuators**

and size of attenuators shall be as per International Standards. Following are the general criteria for providing crash attenuators:

- a) The location where there is a history of more than average number of accidents involving vehicles impacting obstruction
- b) The 85<sup>th</sup> percentile speed of traffic plying through the traffic lane adjacent to obstruction in diverge area is greater than 70 kmph
- c) At location where the lane changing manoeuvring of vehicles are substantial.
- d) Traffic is required to travel in close proximity to the potential obstruction where it is not feasible to install safety barrier in front of it
- e) The obstruction with high value and if damaged by vehicle impact will have serious consequences
- f) The gorge areas of all diverging which are one level above ground

The specific location shall be identified following the criteria given above and the type of crash attenuators will be based on severity of the situation and shall be indicated in Schedule 'B'.

## **9.7 Road Side and Median Safety Barriers**

There are two types of safety barriers viz., roadside safety barriers and median safety barriers.

### **9.7.1 Road side safety barriers**

i) **Warrants:** The longitudinal roadside barriers are basically meant to shield two types of roadside hazards i.e. embankments and roadside obstacles and also for preventing the vehicles veering off the sharp curves. Therefore, all embankments with height 3 m or more shall have safety barriers at the edge of formation, with delineating reflectors fitted on them. W beam barrier shall be provided along all curves having radii upto 450 m for complete length of curves including transitions and 20 m further before and after the curve.

Normally on shoulder side the lateral distance of at least 0.75 to 1.0 m width from edge of paved portion (i.e. carriageway + paved shoulder) should be available without any obstacles. Wherever a permanent object cannot be removed for some reasons, provision of tandems viz. W-beam metal crash barriers and hazard markers with reflectors must be made. Further, frangible lighting columns and sign posts need to be used for minimizing the severity in case of collision.

Irrespective of type of barrier being used, the slope in front of W-beam or wire rope or rigid barrier shall be near to flat gradient so that safety barrier perform best when impacted by a vehicle and the slope of ground in front of barrier shall not be steeper than 10:1.

Some of the commonly encountered roadside obstacles are bridge piers, abutments and railing ends, roadside rock mass, culverts, pipes and headwalls, cut slopes, retaining walls, lighting supports, traffic signs and signal supports, trees and utility poles.

### 9.7.1.1 *Types of roadside safety barriers*

There are three types of longitudinal roadside safety barriers viz:

- a) Semi-rigid type like
  - W-beam type steel barrier
  - Thrie beam type steel barrier
- b) Rigid type (like concrete crash barriers)
- c) Flexible type (like wire rope fencing)

The steel barriers with strong post type usually remain functional after moderate collisions, thereby eliminating the need for immediate repair. If damaged by a vehicle collision, both posts and rails of W-beam are to be repaired. Lack in maintenance can cause the W-beam rails to protrude into traffic way creating highly unsafe situation. The wire rope though technically complicated, can be repaired with minimum costs. Though initial installation cost is relatively high for concrete rigid barrier compared to W-beam and wire rope safety barriers, the repair and maintenance issues can be minimized greatly in concrete rigid barrier. The psychological shyness of drivers to keep away from the safety barrier will be the least in rigid concrete barrier compared to other types. Since rigid barriers will not yield under any vehicle impact, it shall be provided for bridges and ROBs and also to shield roadside objects/hazards where the required set back distance cannot be retained with wire rope and W-Beam (due to any site condition), as they are deflective in nature.

Invariably W-beam and wire rope barrier shall not be installed upon a structure. For a median upon a structure, it shall be concrete rigid barrier. Wire Rope Safety Barrier shall not be used over major or minor bridges

### 9.7.2 *Road side steel barriers*

- a) **Design aspects:** The W-beam type safety barrier consists of steel posts and a 3 mm thick W-beam rail. There shall be a steel spacer block between the post and the beam to prevent the vehicle from snagging on the post, as the snagging can cause the vehicle to spin round. The steel posts and the blocking out spacer shall both be channel section of 75 mm x 150 mm size and 5 mm thick. The posts shall be spaced 2 m center to center. **Fig. 9.7** gives the typical details of W-Beam rail and splices and shall be procured and installed from a reputed manufacturer.

The Thrie beam safety barrier shall have posts and spacers similar to the ones mentioned above for W-beam type. The rail and splices design details for typical Thrie beam are shown in **Fig. 9.8** and shall be from a reputed manufacturer.

This barrier has higher initial cost than the W-beam type but is less prone to damages to vehicle collisions especially for shallow angle impacts.

The W-beam, the Thrie beam and the posts spacers and fasteners for steel barriers shall be galvanized by hot dip process and design elements and

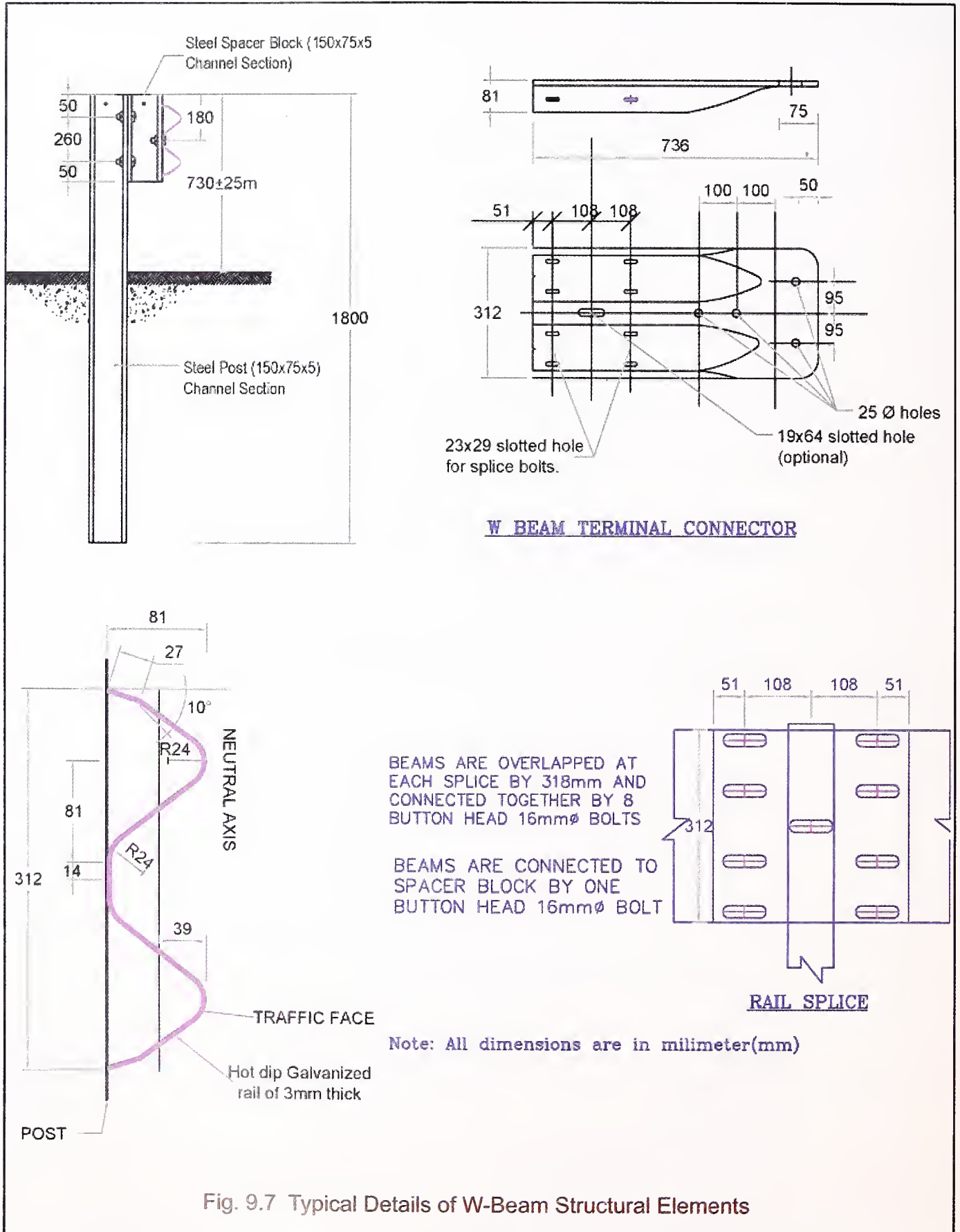
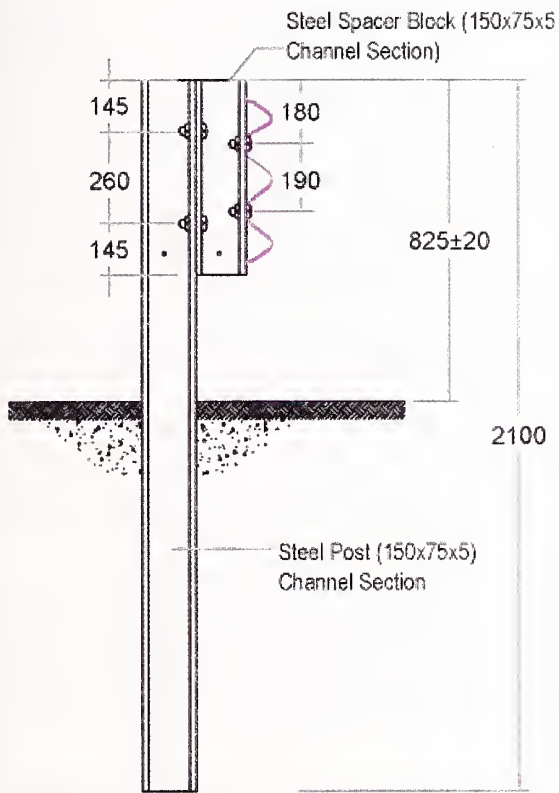
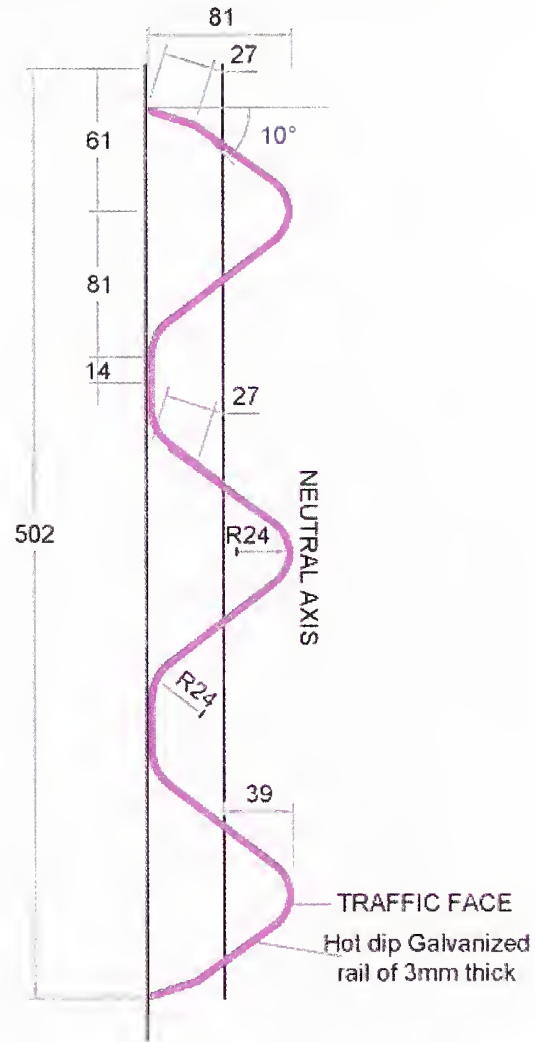

Fig. 9.7 Typical Details of W-Beam Structural Elements





**DETAIL OF THRIE BEAM BARRIER**



**SECTION THROUGH THRIE BEAM RAIL ELEMENT**

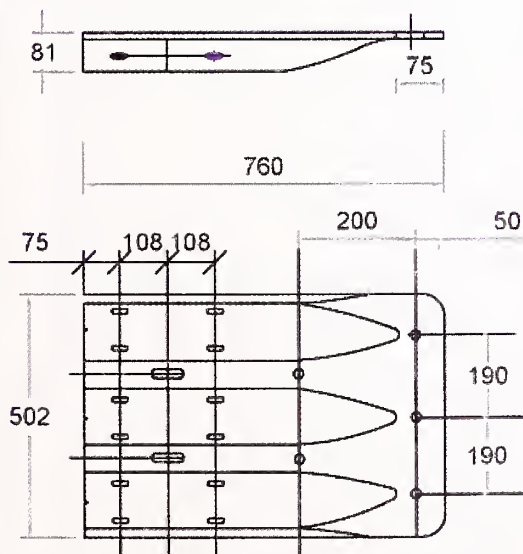

**THRIE BEAM TERMINAL CONNECTOR**

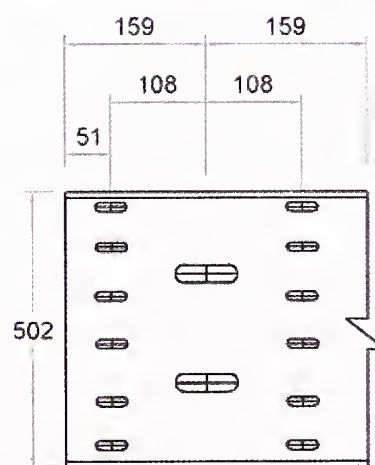

**RAIL SPLICE**

Note: All dimensions are in millimeter(mm)

Fig. 9.8 Typical Details of Thrie Beam Structural Elements

installations shall be as per the details shown for crash barrier in this manual so as to achieve the performance characteristics intended for W-Beam. For any structural elements and details missing in this Manual for W-beam and its various end treatments, the details from international guidelines/manuals on W-beam which would conform to EN 1317 Part-2 can be adopted.

- b) **End treatment for steel barrier:** If hit, an untreated end of the roadside barrier can be hazardous, because the barrier beam can penetrate the passenger compartment and cause the impact vehicle to stop abruptly. End treatments should, therefore, form an integral part of safety barriers and the end treatment should not spear vault or roll a vehicle for head on or angled impacts. The end treatment on approach shall be Modified Eccentric Loader Terminal (MELT) arrangement as shown in **Fig. 9.9** and departure sides it shall be Trailing Terminal (TT) arrangement as shown in **Fig. 9.10**. Following the same end treatments, **Fig. 9.11** presents the typical layout of W beam whether on raised median sides or on depressed/flushed median sides. The international practices shall be adopted for those details which are not available in this Manual for MELT and TT arrangements for the end treatment of W-Beam.

The W-Beam to concrete transition shall be carried out by decreasing the post spacing, nesting one rail behind another and using steel section behind the W-Beam. The transition between W-beam and concrete barrier is detailed in **Fig. 9.12**.

- c) **Placement:** Placement recommendations determine the exact layout of the barrier and shall be made by the design engineer keeping in view the lateral offset of the barrier and flare rate. The final layout shall be as site-specific combination of these factors. The barriers shall be as far away from the traffic as possible and shall preferably have uniform clearance between the traffic and the hazard. As far as possible, the safety barrier shall be placed beyond 2.5 m of the traveled way. For long and continuous stretches, this offset is not critical. The distance between the barrier and the hazard shall not be less than the deflection of the barrier by an impact of a full sized vehicle. In case of embankments, a minimum distance of 600 mm shall be maintained between the barrier and the start of embankment slope of a hazard to prevent the wheels from dropping over the edge.

The W-beam and Thrie beam perform well on the outside of curves and even those of relatively small radius. When a kerb exists on the edge of road and on to close proximity traffic way whether on shoulder or median edge lines, a distance of 100 mm shall be maintained between vertical face of kerb and W-beam or Thrie beam face to ensure that impacting vehicle do not vault over safety barrier and at the same time reduces the nuisance hit. The steel barrier shall be placed in such a way so as to be collided by vehicle directly. **Fig. 9.13** gives the lateral clearance to be maintained in different situations.

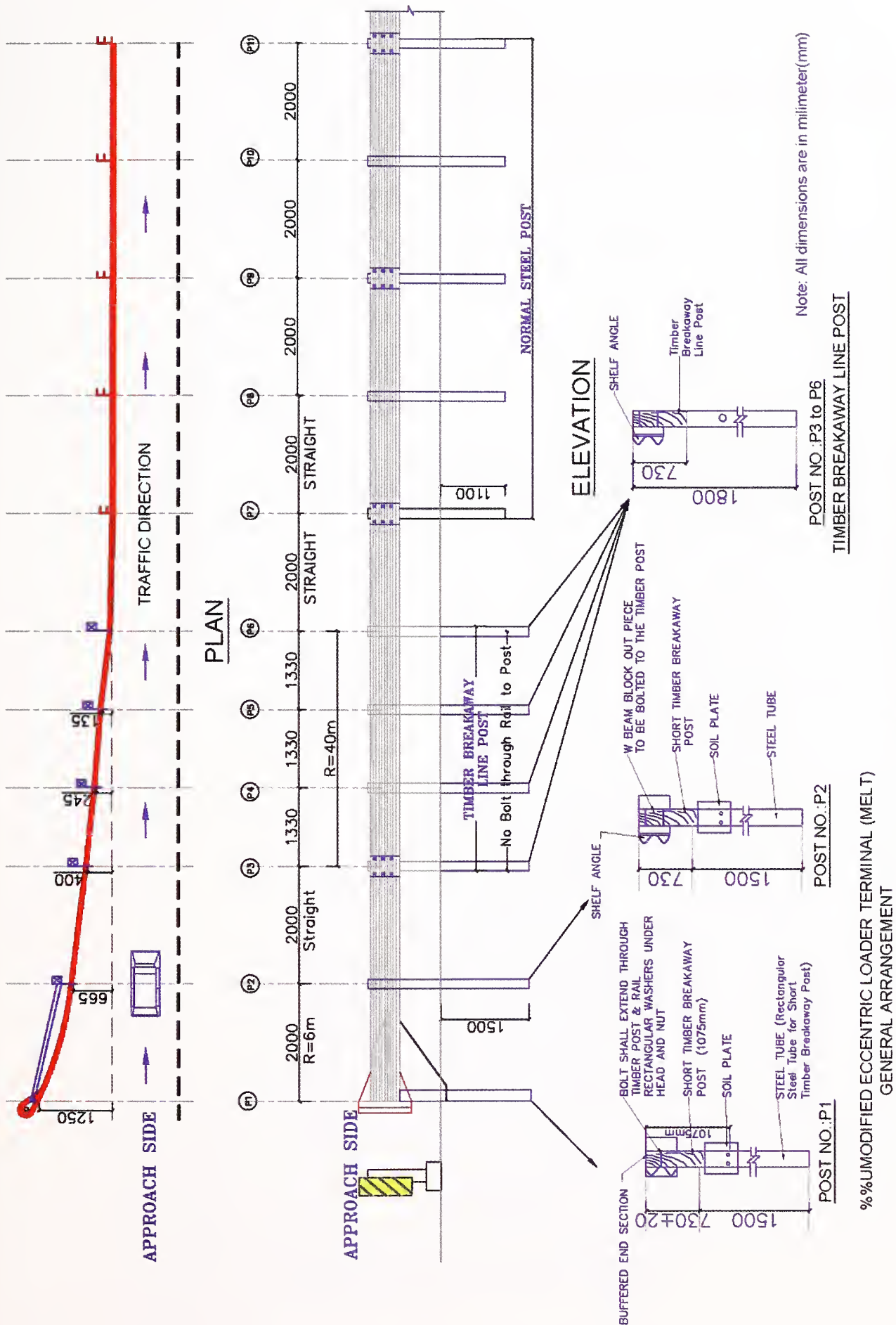

Fig. 9.9 Modified Eccentric Loader Terminal (MELT) Arrangement: W-Beam Treatment on Approach Side

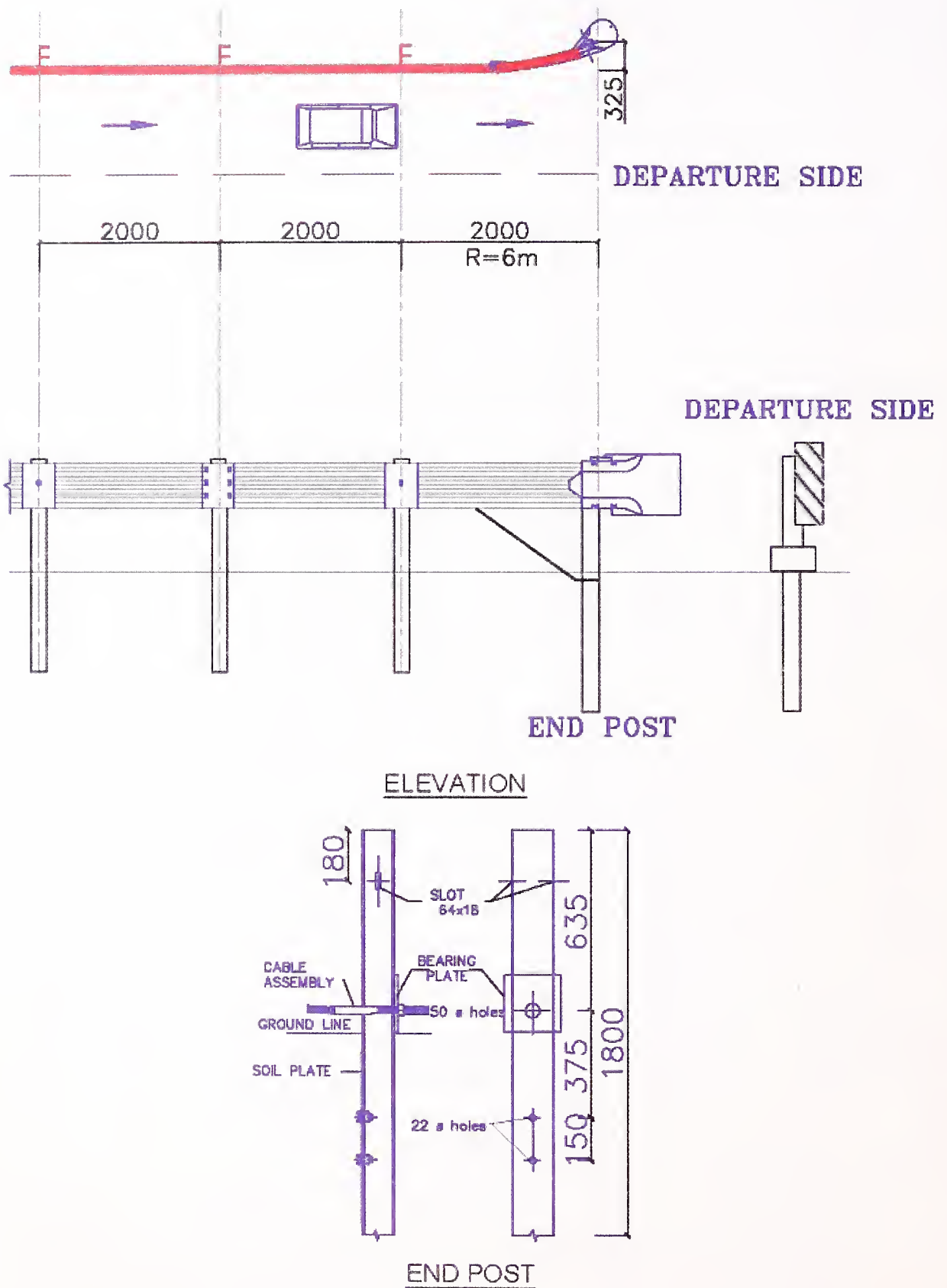
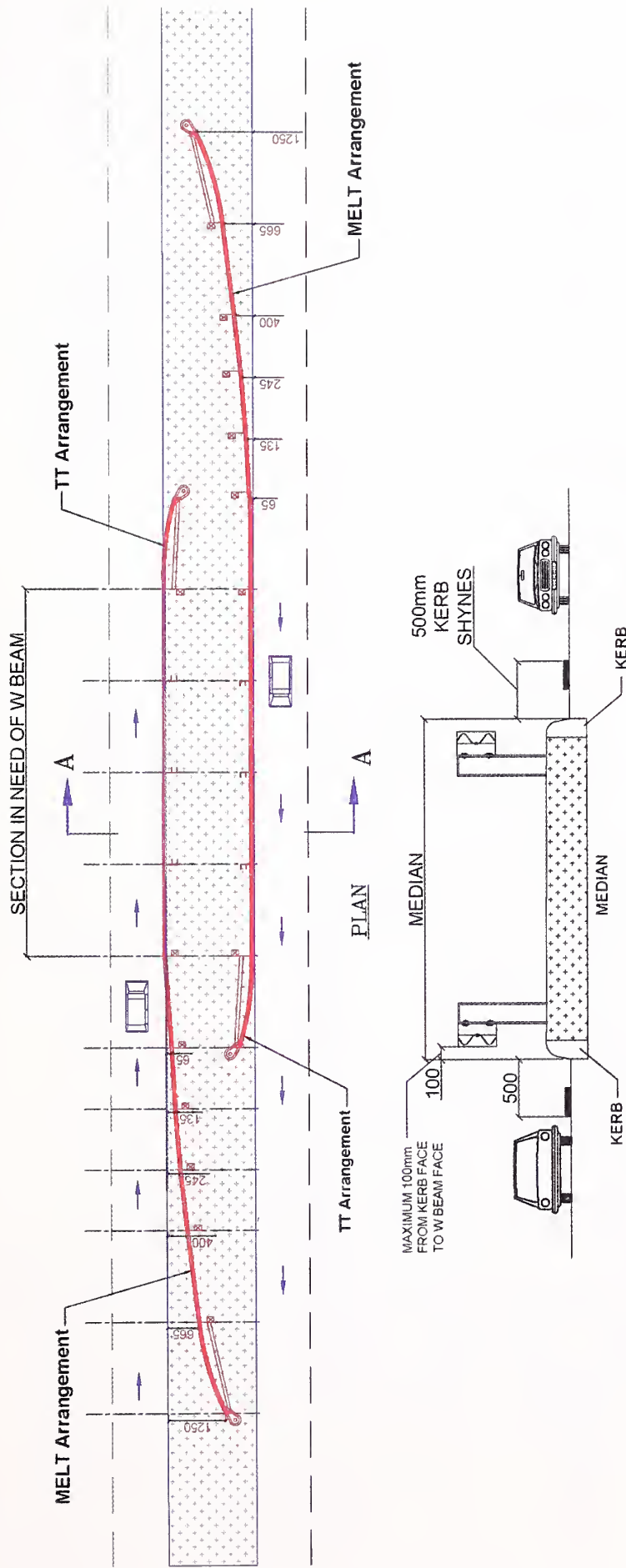

Fig. 9.10 Trailing Terminal (TT) Arrangement:-  
W-Beam Treatment on Departure Side



W BEAM ON RAISED MEDIAN

Fig. 9.11 Typical Layout of W Beam on Median Side

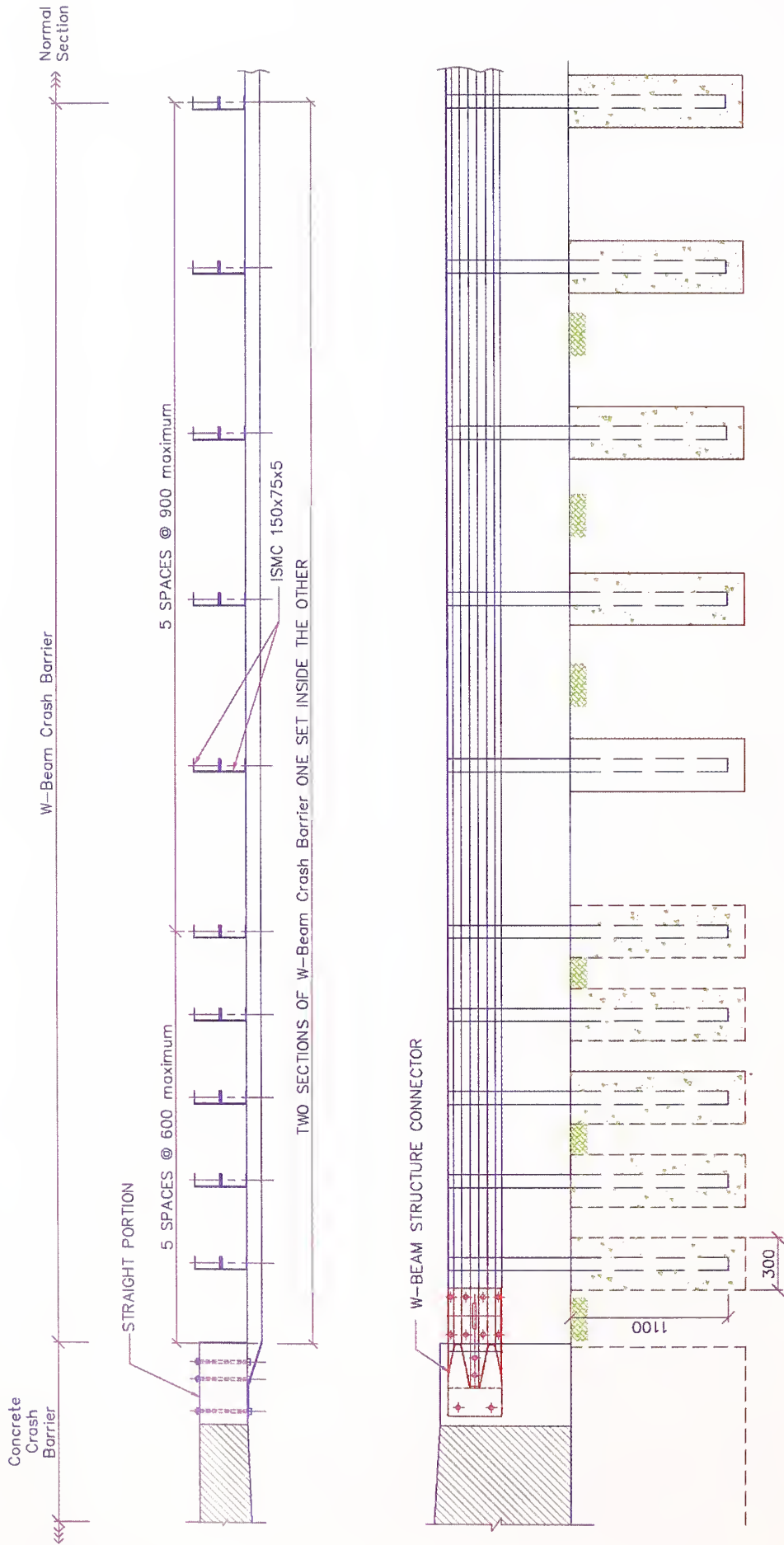

Fig. 9.12 W-Beam to Concrete Connection Details

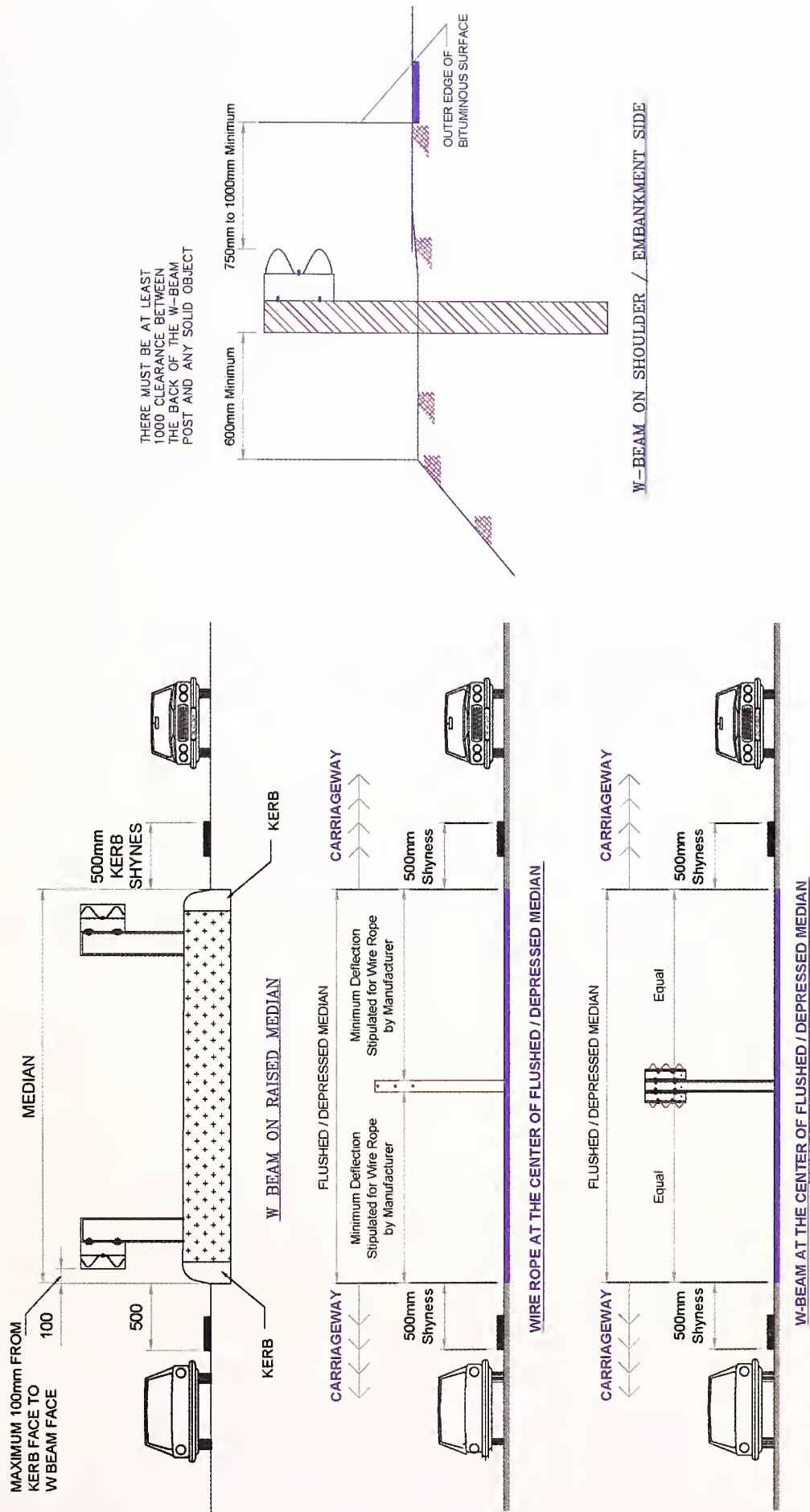

Fig. 9.13 Lateral Clearance for different Barriers

### 9.7.3 Road side concrete barriers

- a) **Design aspects:** Roadside concrete safety barriers are rigid barriers having a sloped front face and a vertical back face. For uniformity New Jersey type concrete barriers should be used where necessary. Rigid crash barriers may however be required only in constrained urban location between main carriageway and service road. The concrete barrier may be pre-cast in lengths of up to 6 m depending upon the feasibility of transport and lifting arrangements. Concrete grade for the barriers shall not be leaner than M30. The minimum thickness of foundations shall be 25 mm thick cement concrete or hot mix asphalt placed at the base of barrier to provide lateral restraint. Where more than 75 mm thick over lay on the road pavement is anticipated, the foundation step may be increased to 125 mm. However, longitudinal roadside concrete barrier should have elaborate footing design which is structurally safe unless sufficient earth support is available.

Suggested flare rates depending upon the design speed are given in Table 9.2.

Table 9.2 Flare Rates of Rigid barriers

Design Speed in km per hour	Flare Rates
100	17:1
80	14:1
60	11:1
40	8:1

- b) **End treatment:** Safety barrier shall be provided with an end treatment, which shall be obtained by tapering the height of terminating end of the median barrier within a length of 8 m to 9 m.
- c) **Placement:** Placement recommendations for roadside steel barriers, mentioned in Para 9.7.2 (c) are applicable to roadside concrete barriers as well.

### 9.7.4 Wire rope safety barrier

- a) **Design aspects:** The wire rope barriers/systems are suitable for either shoulder and/or median side application, provided there is adequate clearance to account for their deflection, as per manufactures system design specification and standards. The slope of surface between traffic way and wire rope safety barrier shall always be flatter than 10:1 and there shall not any object or raised kerb in between so to enable the cables to readily dis-engage from posts during impact and thereby minimizing snagging and ensuring that the vehicle is smoothly redirected.

Wire rope barrier can be repaired quickly and only damaged posts are to be replaced. High tension 3 rope or 4 rope wire system confirming the



requirements of EN 1317 Part 2 for higher containment Level of H2 shall be used. Typical details of wire rope barrier are given in **Fig. 9.14** and wire rope barrier with ropes interwoven are also presented in **Fig. 9.15**. The wire rope barrier shall be the proprietary product of an approved manufacture and test result shall conform to EN 1317 Part 2.

- b) **End treatment:** The end treatment shall be as per the manufactures details conforming to EN 1317 Part 2. The Wire rope to W-beam transition shall be done Modified Eccentric Loader Terminal (MELT) arrangement as shown in **Fig. 9.16**. The termination of Wire rope to a rigid or concrete barrier or a parapet shall be avoided and there shall be a transition from wire rope to W-beam in-turn to concrete barrier as shown in **Fig. 9.17**.
- c) **Placement:** The placement of the Wire Rope Safety Barrier shall be determined by the design engineer and shall be a combination of the deflection ratios of the barrier and the site-specific conditions. The barrier shall be placed as far away from the traffic as possible and shall preferably have uniform clearance. The lateral slope of surface between traffic way and wire rope safety shall always be flatter than 10:1 so that vehicle bumper trajectory will not change before an errant vehicle hit the wire rope.

When Wire Rope Safety Barrier is provided in front of a hazard, it shall be so located caters to the deflection specified by the manufacture. The barrier shall be extended at full height not less than 30 m in advance of the hazard on the approach side, and shall continue at full height for 7.5 m beyond the hazard on the departure side. The minimum length of fence shall be no less than 50 m. If there is a hazard present in the deflection area of the barrier, then the distance between fence and the hazard shall not be less than that deflection values described by the manufacture and will depend upon the post spacing.

There shall be at least 1 m setback distance between wire rope safety barrier and the start of drop or embankment slope. While installing wire rope on a highway carrying two/three-wheelers and other small vehicles, the deflection as specified by the manufacturer shall be maintained as set back distance from the start of drop or embankment. The deflection can be reduced by closer post spacing, however the minimum setback distance shall be ensured. Wire rope can be installed for curves radii more than 450 m only.

The Wire Rope Safety Barrier shall not be permitted in following situations:

- Where a hazard is present within the deflection area of the fence.
- Where total fence length is less than 50 m.
- On a horizontal curves of radius 450 m or less.
- On vertical sag curves of radius less than 3 km.
- Where rate of change in setback is steeper than 1 in 10.

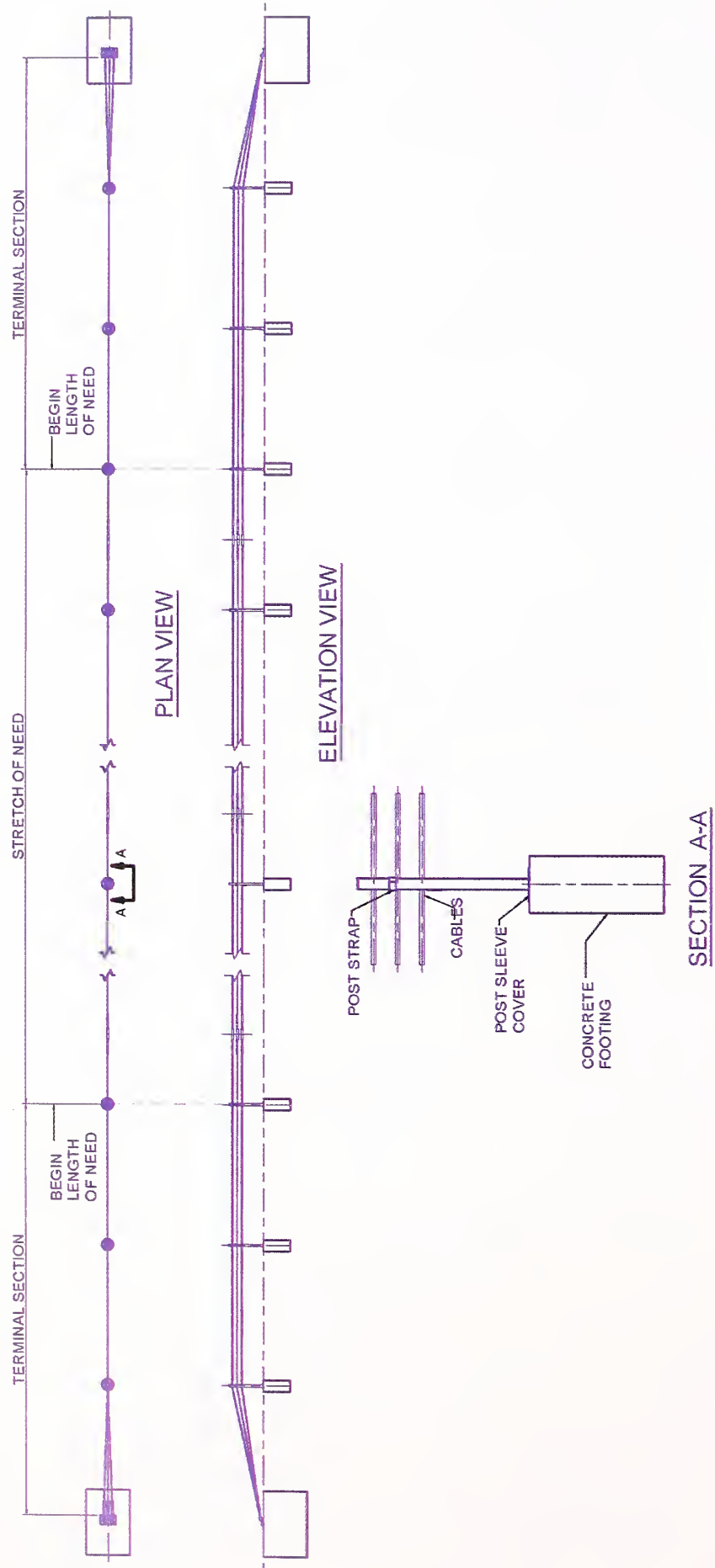

Fig. 9.14 Typical Details of Wire Rope Safety Barrier

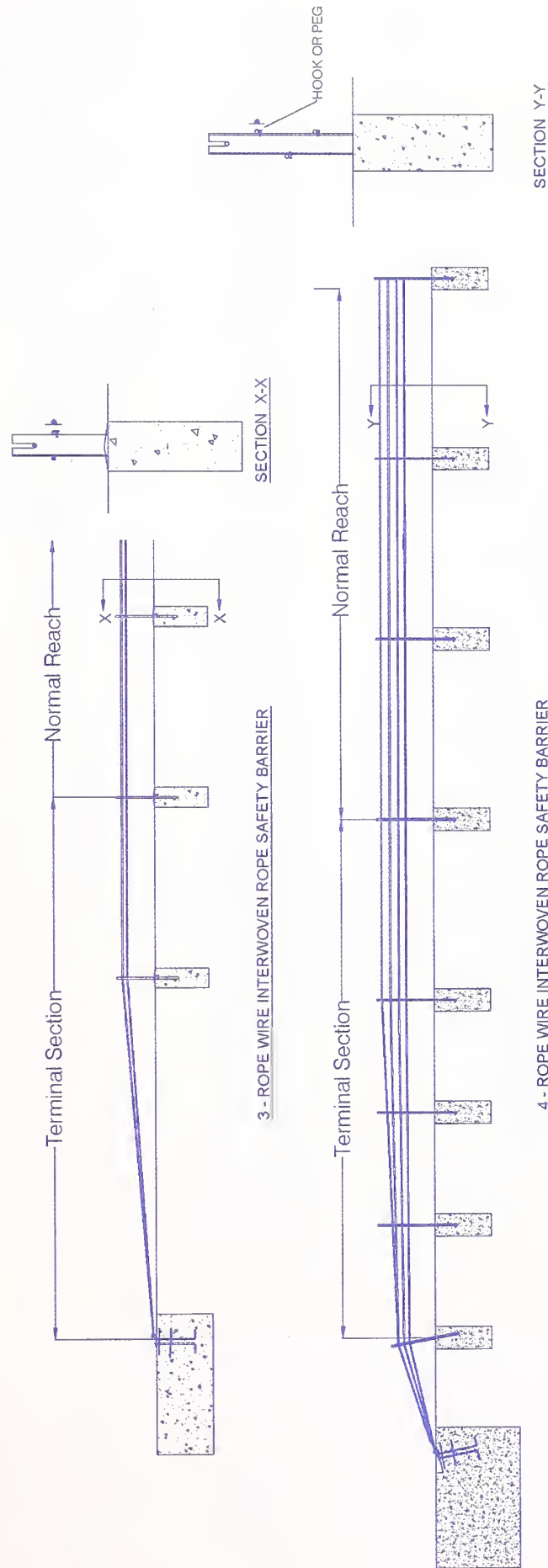

Fig. 9.15 Typical Details of Interwoven Wire Rope Safety Barrier

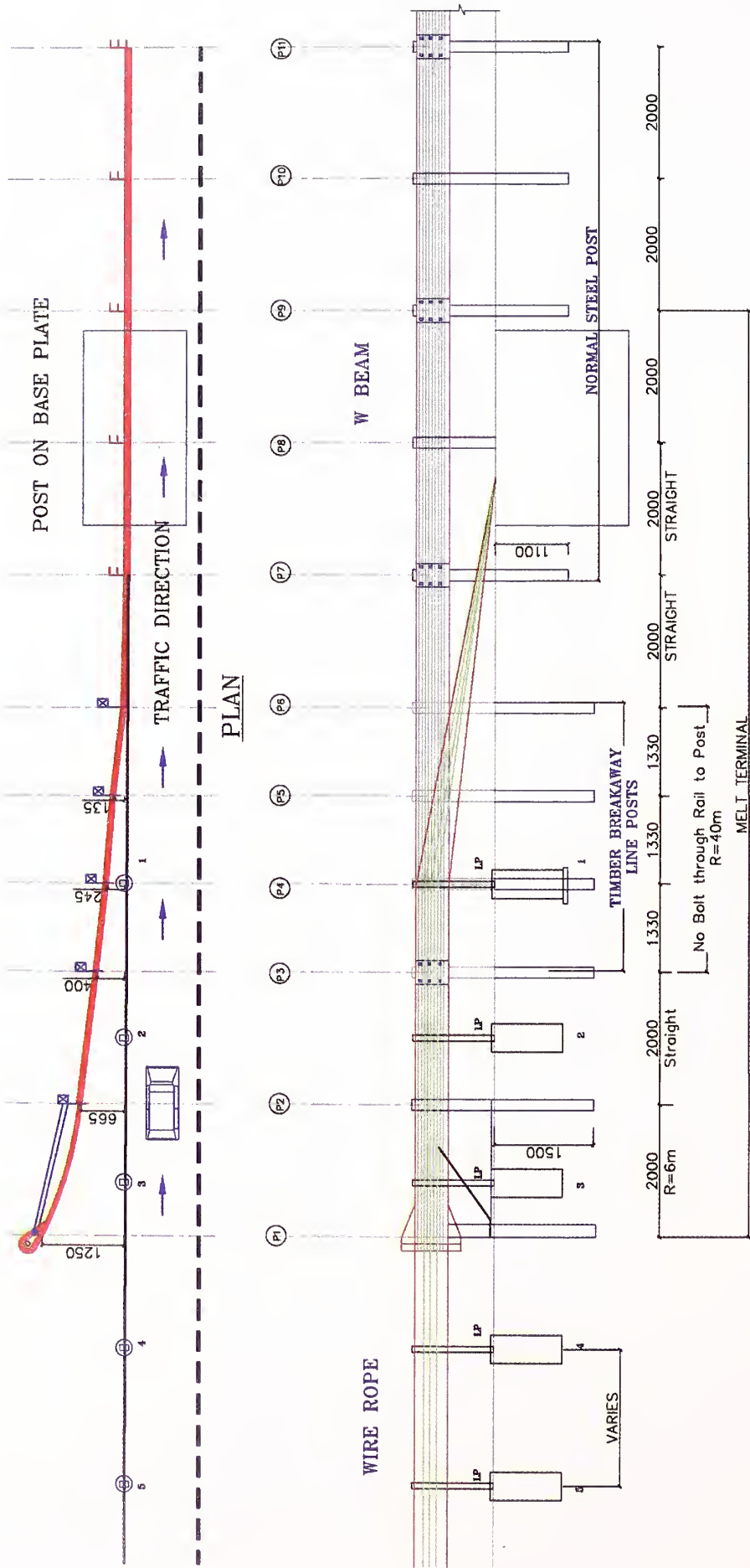

Fig. 9.16 Typical Details on Wire Rope to W-Beam Barrier

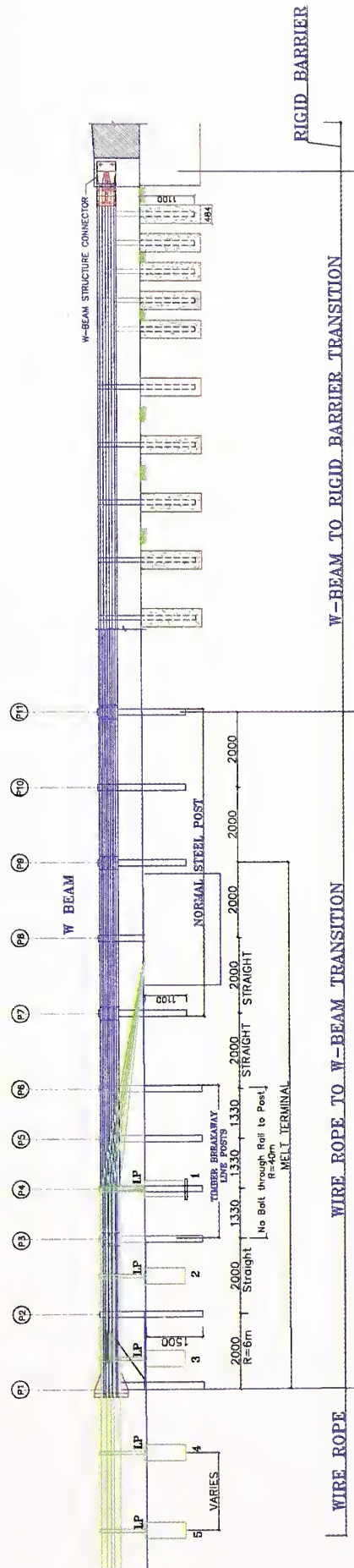

Fig. 9.17 Typical Details on Wire Rope to Rigid Barrier

### 9.7.5 Median barriers

- i) **General:** Head-on-collisions, especially on highways with narrow medians, caused by out-of-control vehicles jumping across the medians are a major source of accidents. Fixed objects on medians also require shielding from the traffic flow. Provision of median safety barrier in such conditions is an important requirement.
- ii) **Warrants:** For all multilane highways where adequate land is available, it is preferable to provide wide depressed medians having width of 7 m or more but with W-beam metal crash barrier or wire rope safety barrier at the edges of the median. Considering the vehicle trajectory over kerbs, when safety barrier are to be installed along an existing multilane highways with raised medians, it shall be placed in such a way that vehicle bumper would hit directly on the safety barrier than first with the raised median kerb. The maximum lateral distance between vertical face of raised kerb and W-beam shall not be more than 100 mm. Wire ropes are ideally suited in depressed or flushed median situations in a mutli lane highway owing to their double side nature and also not allowing crossover as wire rope never snaps. However, while applying wire rope on a narrow flushed median, it shall be placed at the centre of flushed median, ensuring the sufficient deflection distance from both traffic way. The spacing of posts and the deflection stipulated by the manufacture shall be strictly adhered. The placement of Beam and wire rope barrier on median sides are pictorially presented in **Fig. 9.13**.

Median barriers shall also be provided to shield fixed objects in a narrow median. If necessary, median barriers shall be flared to encompass a fixed object, which may be a light post, foundation of overhead signs, bridge pier etc.

#### iii) **Types of median barriers:**

There are four types of median safely barrier viz., W-beam type steel barrier, (Strong post type), Thrie beam type steel barrier, (Strong post type), Concrete barriers, Wire Rope safety barrier with closer post spacing.

#### 9.7.5.1 Steel median barriers

**Design aspects:** The W-beam barrier shall be similar to the roadside barrier described in Para 9.7.2 (a).

The Thrie beam barrier shall be similar to the roadside barrier described in Para 9.7.2 (a).

**Placement:** Steel beam crash barrier shall be placed at both the edges of median along the carriageway. The lateral placement and end treatment of W-Beam at median location as given in **Fig. 9.11** shall be followed. The Modified Eccentric Loader Terminal (MELT) arrangement on approach side and Trailing Terminal (TT) arrangement on departure side shall be adopted for W Beam end treatment in median location also.

### 9.7.5.2 Concrete median barriers

**Design aspects:** Concrete median barrier shall be New Jersey type. These should be used in case of narrow medians of two meter or less along with an anti-glare screen for avoidance of headlight glare. The concrete barrier cannot be altered easily, hence rigid barrier shall be provided in narrow median in urban location to prevent pedestrian intrusion and other side friction. The terminating end of the median barrier shall be tapered in a length of 8 to 9 m.

**Placement:** Concrete median barrier shall be placed at both the edges of median along the carriageway.

### 9.7.5.3 Wire rope median barrier

**Design aspects:** The design aspects given in Para 9.7.4 (a) will be applicable for wire rope at median location.

**Placement:** The requirements covered in Para 9.7.4 (c) for wire rope will be applicable for median barrier also. Also, when Wire Rope Safety Barrier is placed between two adjacent carriageways which are at the same level, it shall be placed at the center of the median with deflection area not be less than that deflection values described by the manufacture from either side of the fence. In case of two carriageways which are at different levels, it shall be at both sides of the median edge. In the case of a split median, it shall be on the carriageway of higher side. Wire rope barrier for median location can be adopted as long as the median is not raised and allowable deflection can be kept from both traffic way sides as given in **Fig. 9.13**. The end treatment presented in Para 9.7.4 (b) will be applicable for wire rope at median location also.

### 9.7.6 General

Raised kerbs or drains shall not be provided between the traveled way and the barriers. These destabilize the vehicle balance and disturb its equilibrium before it strikes the barrier, thus defeating the essential purpose of safety and redirection of the impacting vehicle. Steel barriers shall be provided in non-built-up sections whereas concrete barriers shall be provided in built-up sections. In addition to the warrants given in Paras 9.7.1 (i) and 9.7.5 (ii), the safety barriers shall also be provided at the following locations:

- a) Where embankment is retained by a retaining structure (concrete).
- b) On valley side of highway in mountainous and steep terrain (concrete).
- c) Between main carriageway and footpath in bridges (concrete).
- d) At hazardous locations identified in Schedule 'C' or through safety audit (concrete/steel as specified in Schedule 'B' or Safety Audit Report).

The requirements of Safety Barriers for structures are given in Para 7.17 of this Manual.

## 9.8 Road Boundary Stones (RBS)

Road boundary stones shall be provided at the boundary on both sides of the Right of Way. These shall be spaced at 50 m. The boundary stones shall be of cement concrete as per

Type Design given in IRC:25. The boundary stones shall be painted with cement primer and enamel paint and marked 'RBS' by paint.

### **9.9 Work Zone Traffic Management Plans (WTMPs)**

The traffic diversion plan during construction shall be prepared as per IRC:SP:55 for the entire project highway. Separate traffic diversion plan shall be prepared for structures and CD works. Following suggested layouts presented in IRC:SP:55 are recommended for various construction scenarios. Suiting the specific site requirements, the application steps described therein shall be followed

**Fig. 9.18** Two-Lane to Four-lane (Eccentric Widening)

**Fig. 9.19** Two-Lane to Four-lane (Shifting of Traffic from One Carriageway to Other)

**Fig. 9.20** Two-lane to Four-lane (Concentric Widening)

**Fig. 9.21** Two-Lane to Four-lane (Concentric Widening)

**Fig. 9.22** 2-lane to Four-lane Concentric Widening & Worksite Advances

**Fig. 9.23** Stage-1 of Flyover/VUP Construction

**Fig. 9.24** Stage-2 of Flyover/VUP Construction





**APPLICATION:**

The layout shown is applicable when the two lane highway is upgraded to 4-lane, with eccentric widening. In the first stage, the new carriageway would be constructed on the sides, while the new carriageway is being constructed, the traffic will continue to ply through the existing road. Layout of signs and barriers would be as shown.

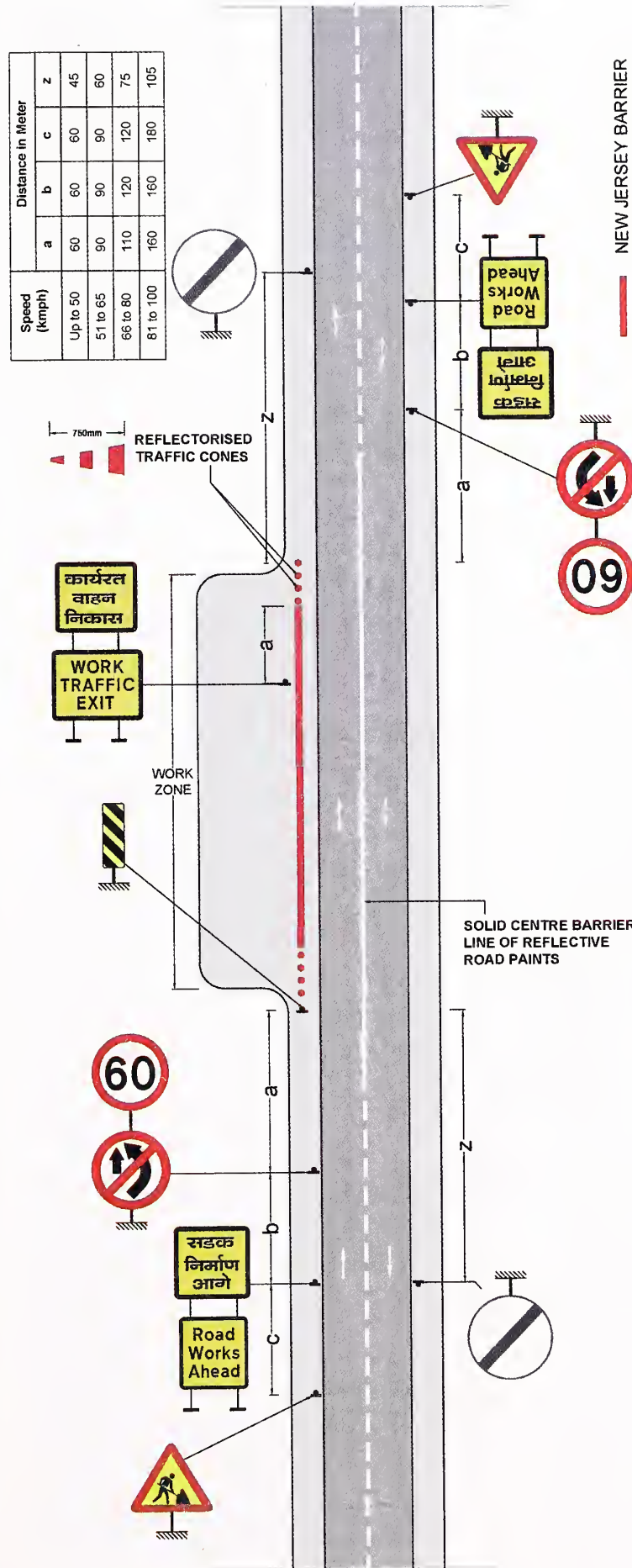

Fig. 9.18 Two-Lane to Four Lane (Eccentric Widening)

**APPLICATION:**

The layout is applicable for the second stage of eccentric widening when new carriageway has been constructed and existing carriageway will be taken up for strengthening or overlay, where traffic has to be shifted from one carriageway to other. In shifting traffic from one carriageway to other, the cross over length is critical and shall be carefully meeting the site requirements such that the layout is clearly visibly carried out with adequate signs and in a well guided way and shall be visible both day and night. In the cross over length the camber also shall be properly given for safe transfer to avoid overturn due to reverse camber. It would be advisable to bring about gradual reduction in speed. Layout of signs and barriers would be as shown.

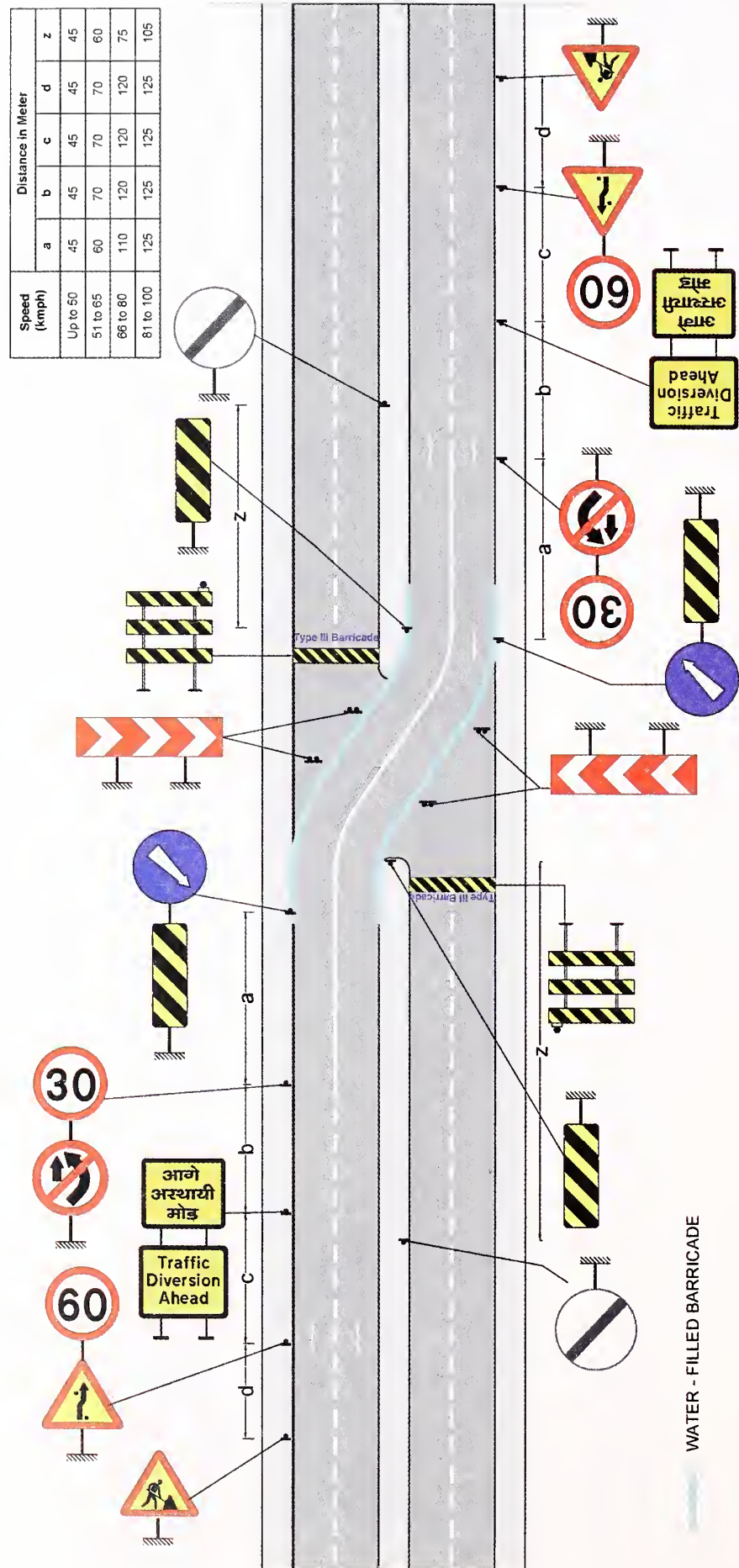

Fig. 9.19 Two-Lane to Four-Lane (Shifting of Traffic from One Carriageway to Other)

**APPLICATION:**

The layout shown is applicable for concentric widening of a two lane highway 4-lane highway. In the first stage, construction of service road or diversion road would be taken up on the sides and traffic would continue to move on main highway on both direction.

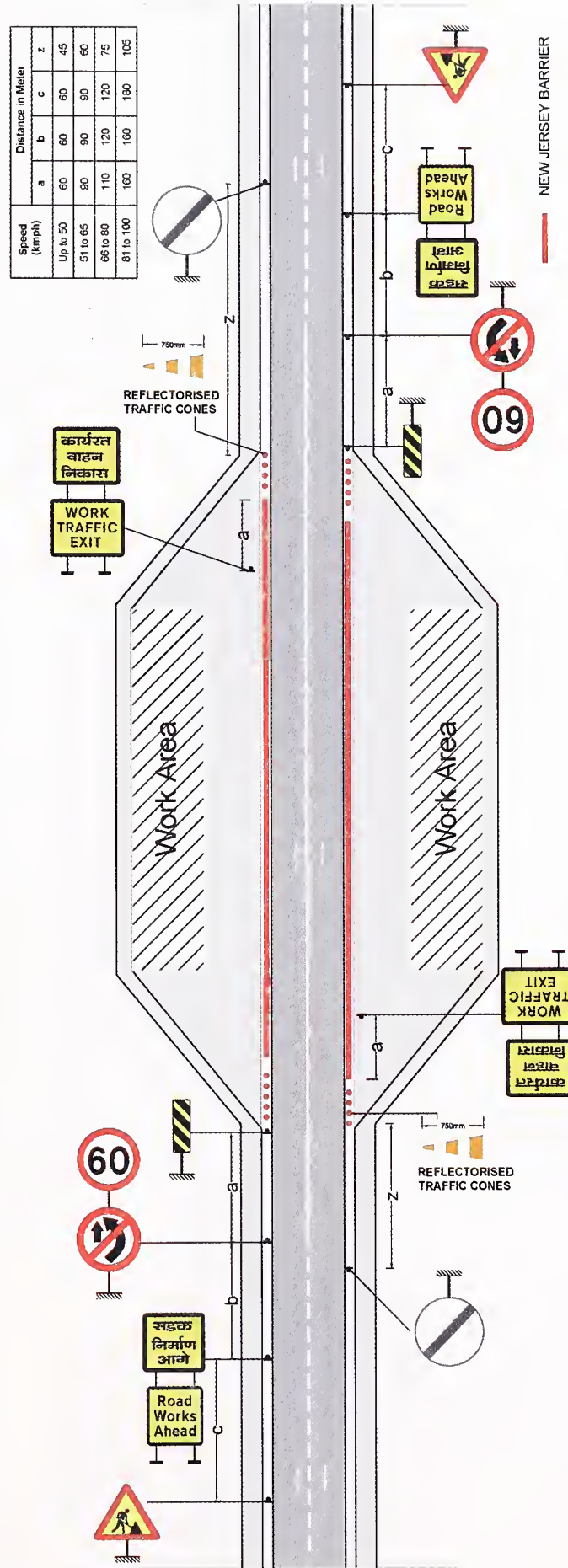

Fig. 9.20 Two-lane to Four-Lane (Concentric Widening)

**APPLICATION:**

The layout is applicable when 2-lane highway will be upgraded to 4-lane with service on both sides. In the second stage traffic move on service/diversion roads in each direction and widening work on both carriageway including median is done in the central cordon portion. Necessary warning signs will be given to inform of roadwork being undertaken Repeat

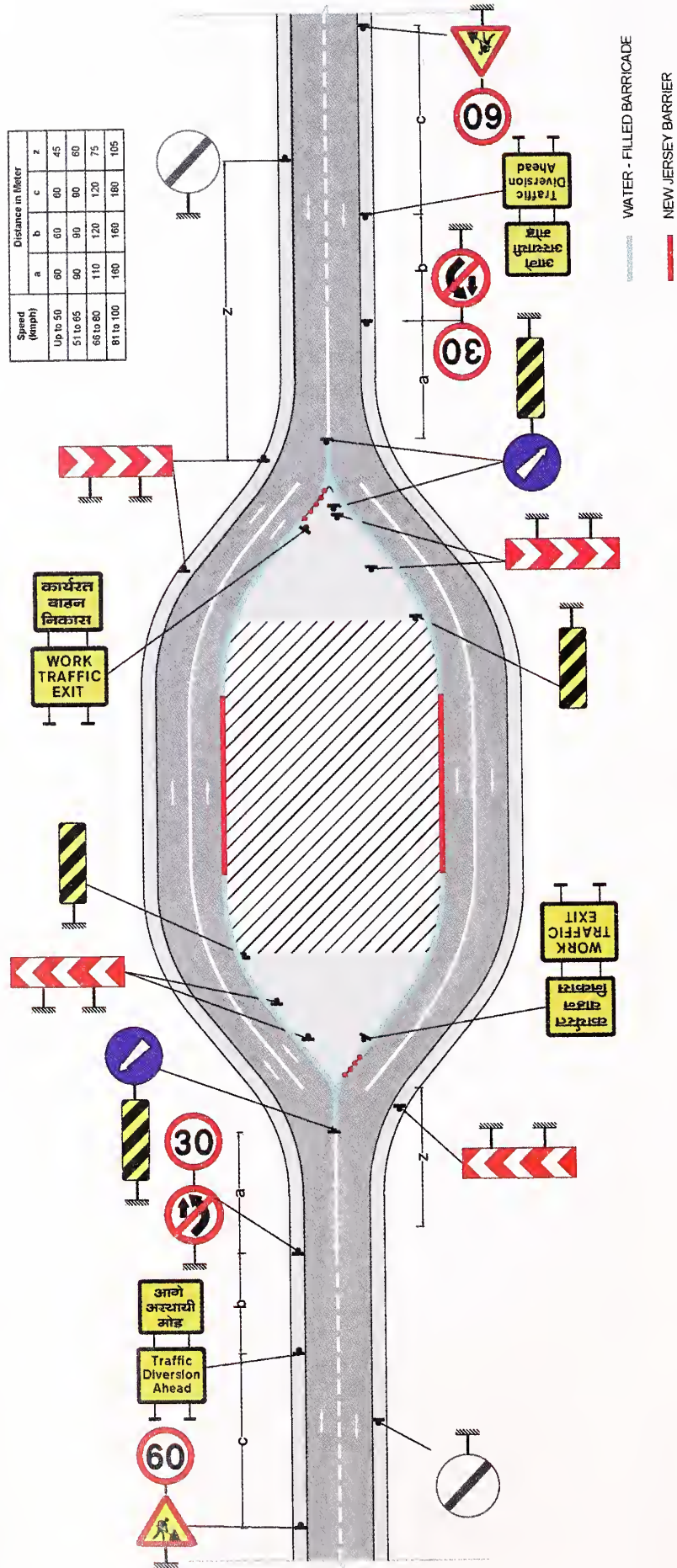

Fig. 9.21 Two-Lane to Four-lane (Concentric Widening)

**APPLICATION:**

The layout is the third stage of concentric widening for 2-lane to 4-lane showing the shifting/ of workzone to the adjacent stretch for progress of construction activities

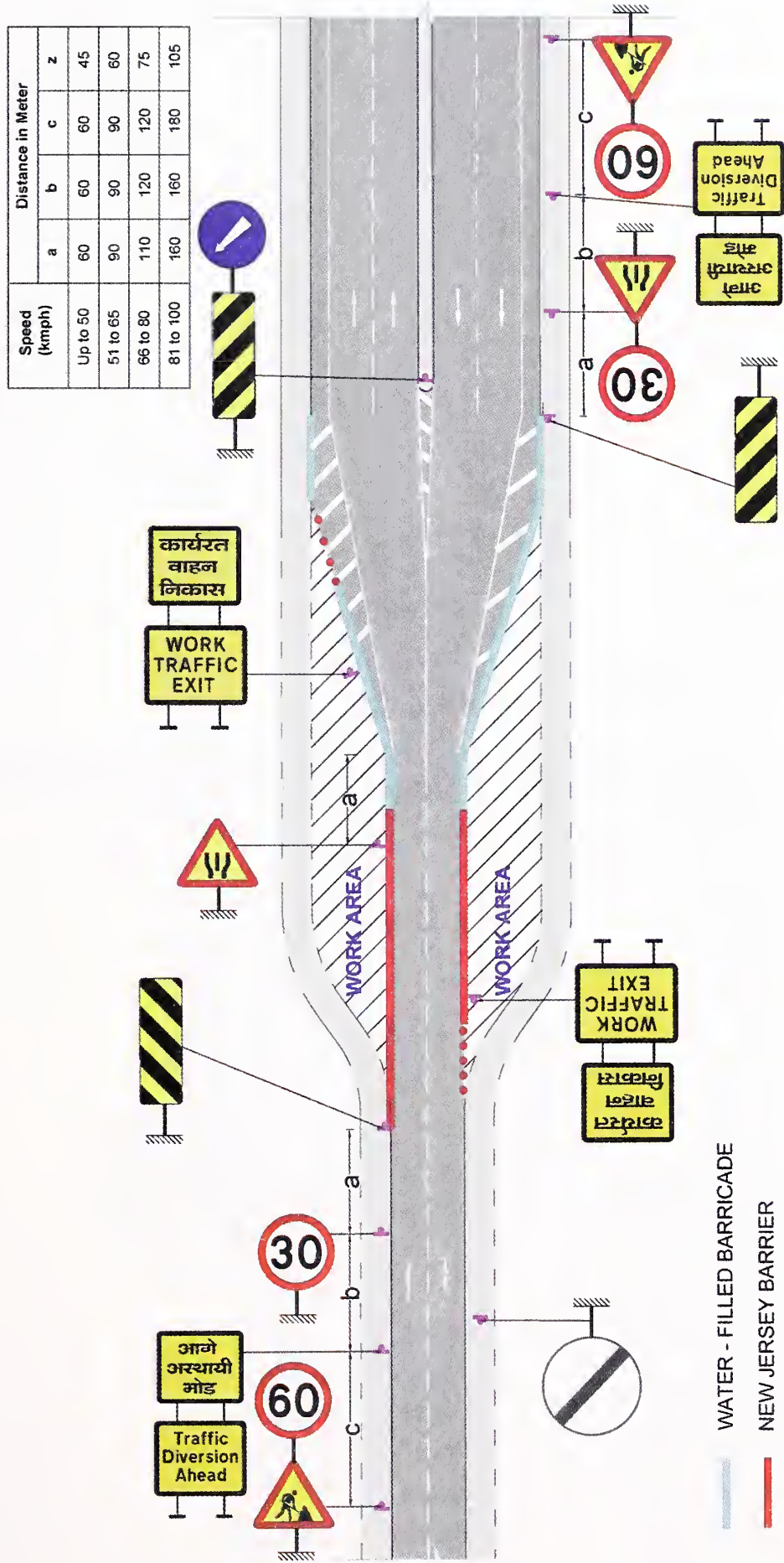

Fig. 9.22 2-lane to 4-lane - Concentric Widening & Worksite Advances

**APPLICATION:**

The layout shows the Stage-1 in flyover/MUP construction. In the first stage, the traffic will be diverted to a service road or temporary road. The turning movements would continue at the existing intersection and construction of piers/embankment/RE wall would be taken up in the cordoned portion. Carefully planned pedestrian markings on the roads and protected safe passage for crossing of pedestrians shall be provided through work area.

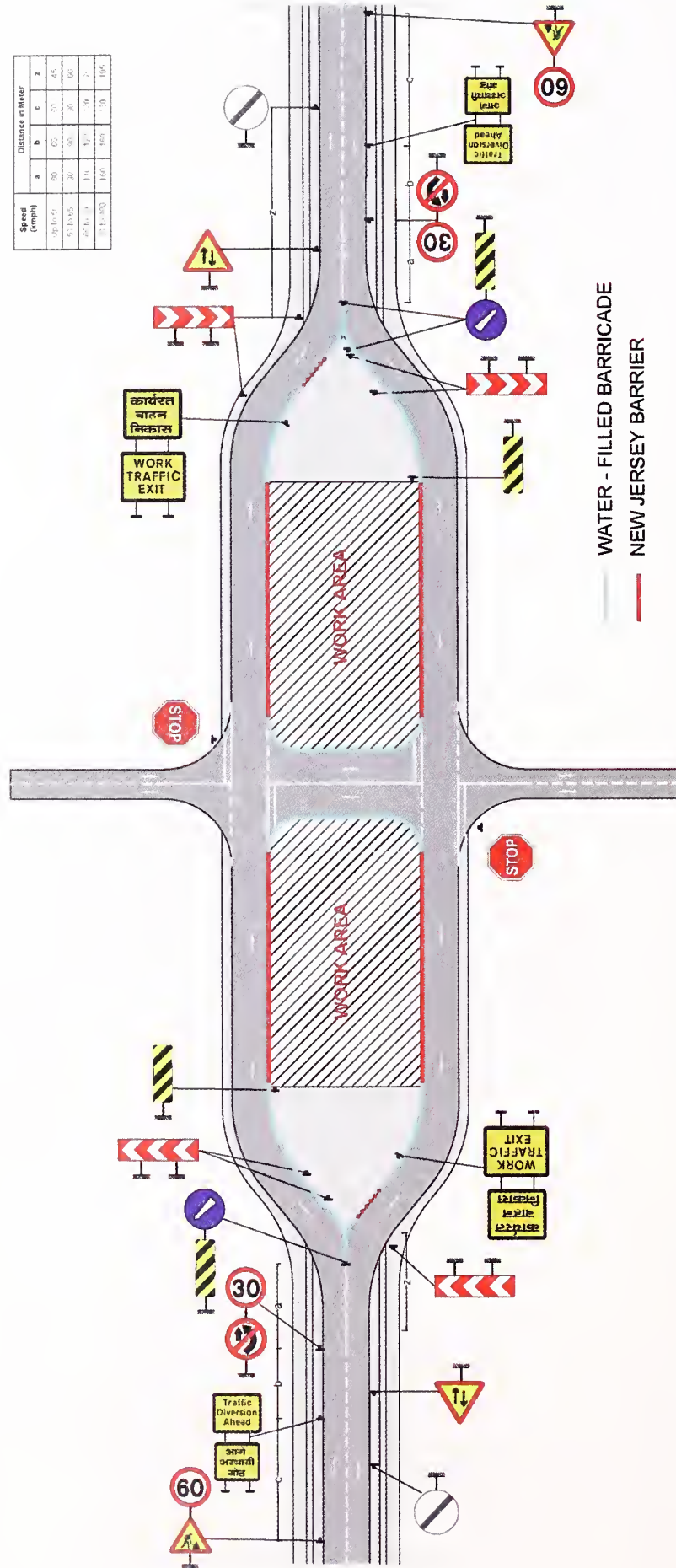

Fig. 9.23 Stage-1 of Flyover/MUP Construction

**APPLICATION:**

The layout shows Stage-2 of flyover/VUP construction. In the second stage, the central portion will be taken up and junction will be blocked for direct cross road movement. During this short period of time, cross road movement will be accommodated like a circulatory movement using U-turn, whereas the through traffic will continue to ply through service road/temporary road. Direction signs would be carefully planned and installed

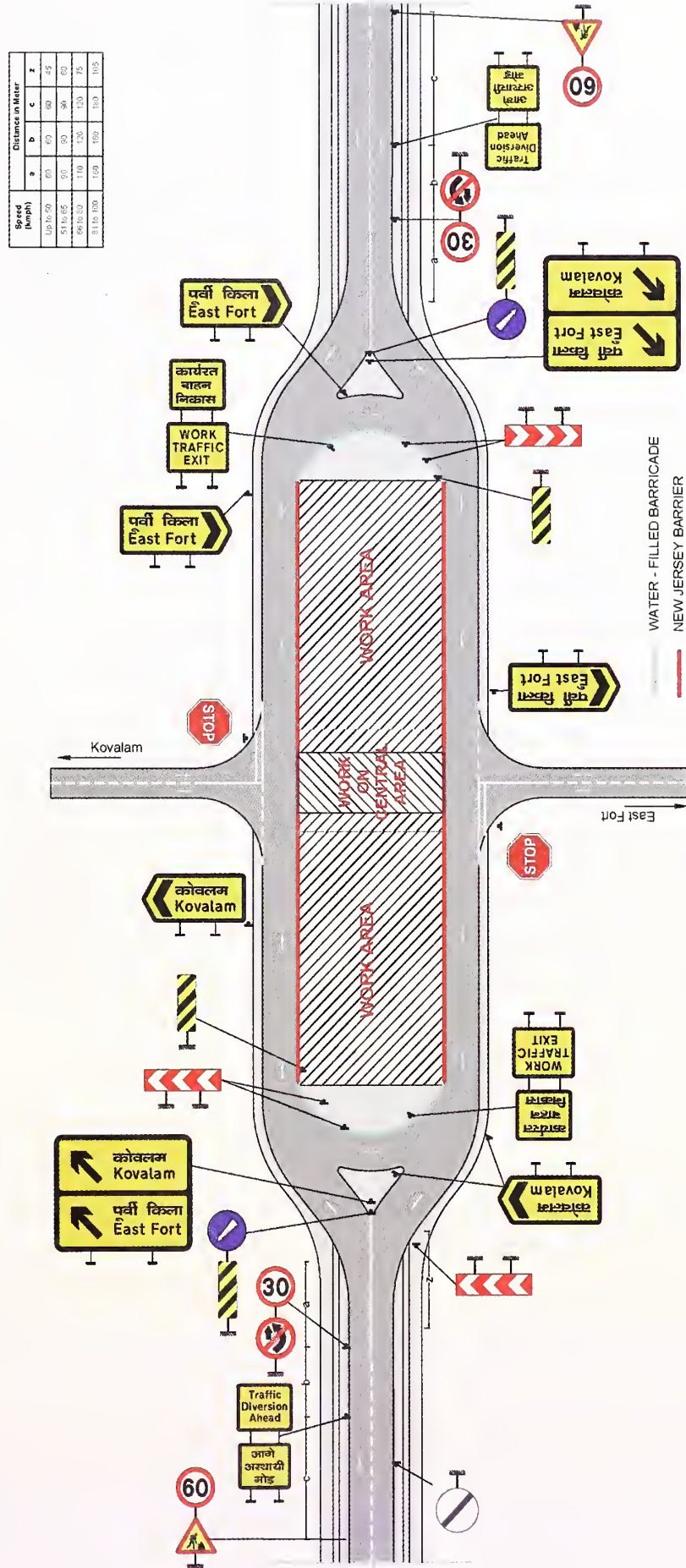

Fig. 9.24 Stage-2 of Flyover/VUP Construction

## SECTION – 10

### TOLL PLAZAS

#### 10.1 General

The Concessionaire shall provide the Toll Plazas at the locations specified in Schedule 'C' for collection of toll fee as per the Concession Agreement. The fee collection system shall be speedy, efficient and user friendly. The design of the Toll Plazas should be such that they are aesthetically pleasing and efficient and the fee collection staff should be quick, courteous and adequately trained before deployment.

#### 10.2 Location of Toll Plaza

The location of toll plaza shall be indicated in Schedule 'C' of the Concession Agreement. Their locations shall be decided keeping in view the following factors:

- i) Land availability
- ii) Stream of traffic on Toll Plaza
- iii) Visibility for the approaching traffic
- iv) Reasonably away from road intersections and/or rail crossings
- v) Free from risk of flooding and submergence, etc.
- vi) Preferably on flat land and away from congested urban locations

#### 10.3 Land for Toll Plaza

Adequate land for Toll Plaza shall be acquired to permit the provision of toll lanes for a projected peak hour traffic of 20 years subject to a minimum number of 16 toll lanes including all other buildings and structures to be accommodated at the Toll Plaza location. Land shall be acquired as per provisions of the Concession Agreement.

#### 10.4 Layout and Design of Toll Plaza

**10.4.1** Typical layout of a toll plaza is given in **Fig. 10.1**. The layout shall provide for future expansion of toll lanes. Stage construction of Toll Plaza in respect of number of toll lanes shall be allowed. However, other structures as envisaged in the Concession Agreement shall be provided at the initial stage itself.

##### 10.4.2 *Width of toll lane*

The width of each toll lane shall be 3.2 m, except for the lane for over dimensioned vehicles, where it shall be 4.5 m.

##### 10.4.3 *Traffic islands at the toll plaza*

Between each toll lane of the toll plaza, traffic islands are required to accommodate toll booth. These islands shall be of minimum 25 m length and 1.9 m width. Protective barriers of reinforced concrete and traffic impact attenuators shall be placed at the front of each island



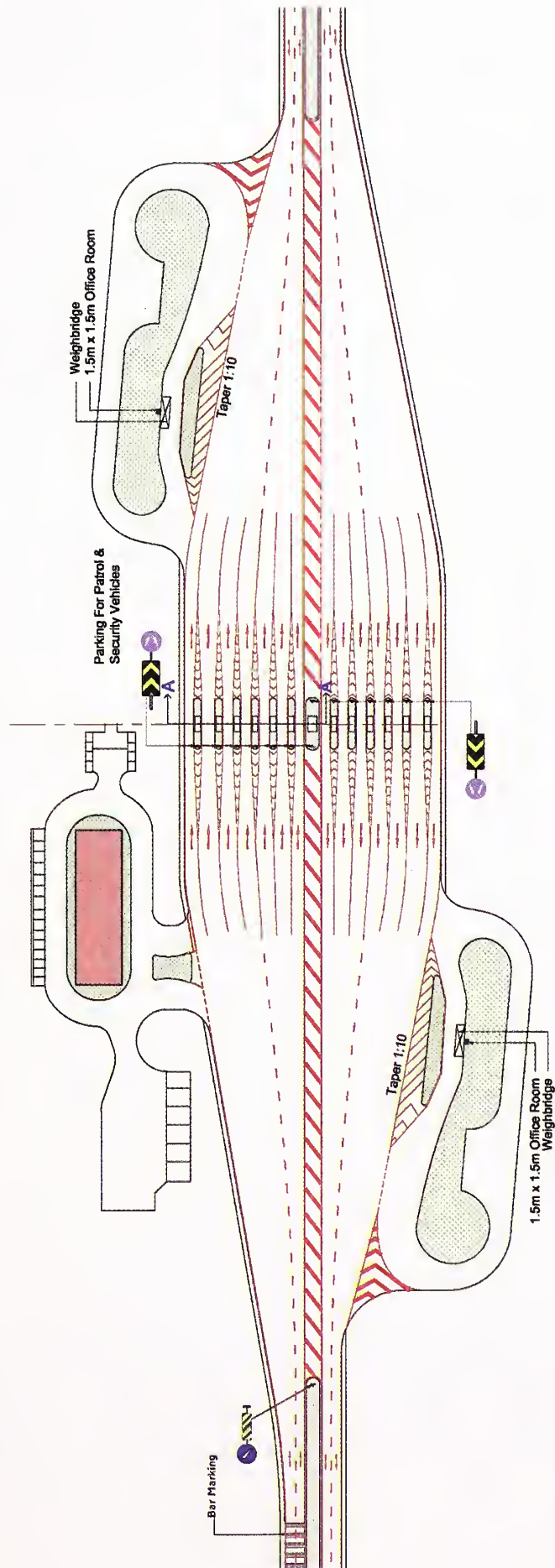

Fig. 10.1 Typical Layout of a Toll Plaza

to prevent out of control approaching vehicles crashing into the toll booth. They would be painted with reflective chevron markings. For toll lane to be installed with weigh in motion system, the minimum length of islands shall be 35 m where 22.5 m on approach side.

**10.4.4 Toll booths**

Toll booths may be provided of prefabricated materials or of masonry. The toll booths shall have adequate space for seating of toll collector, computer, printer, cash box, etc. It should have provision for light, fan and air conditioning. The typical details of traffic island with toll booth are given in Fig. 10.2. Toll booth shall be placed at the centre of each traffic island. The toll booth shall have large glass window to provide the toll collector with good visibility of approaching vehicles. The bottom of the toll window should be placed at such a height (0.9 m) above ground level so as to provide convenience of operation. The toll booths shall be ergonomically designed and vandal proof. There shall be CCTV camera installed at each booth.

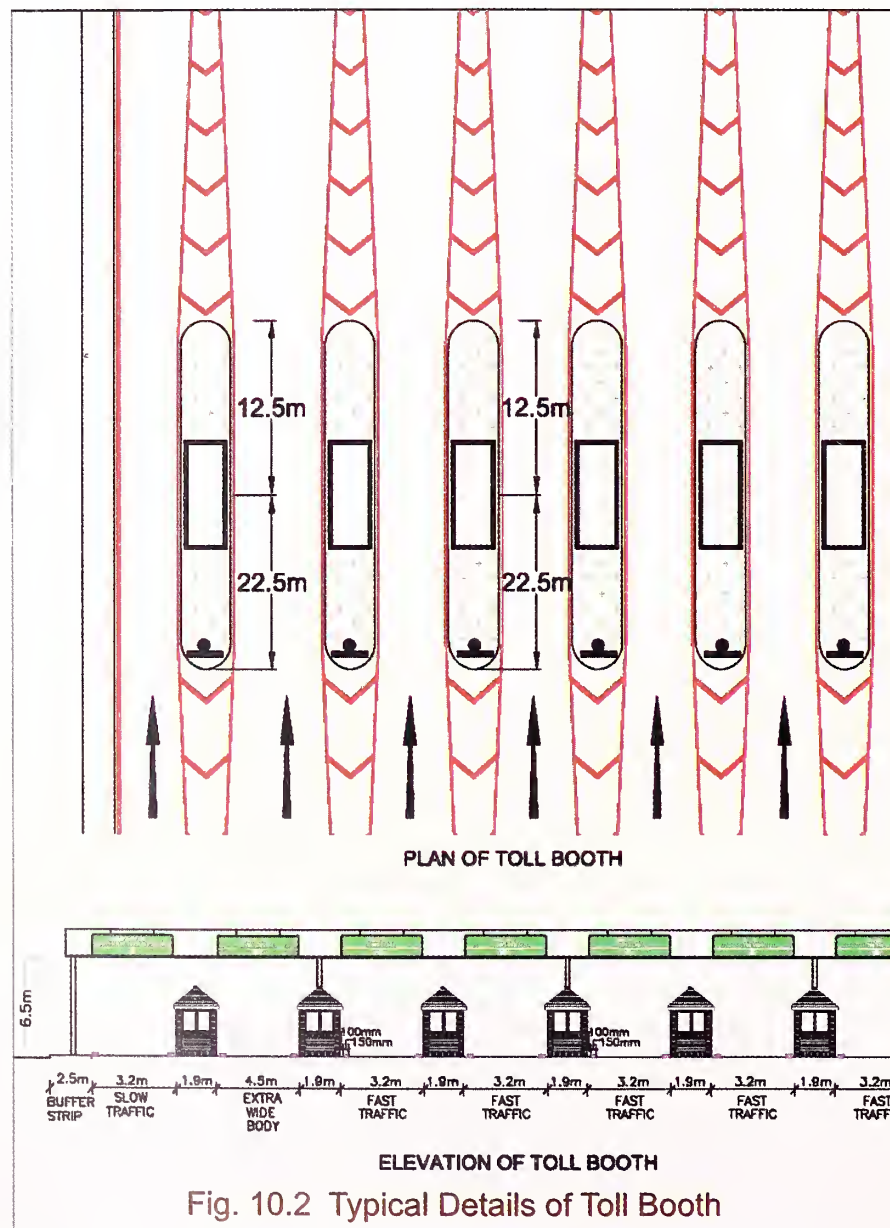

Fig. 10.2 Typical Details of Toll Booth

#### 10.4.5 *Tunnels*

For the movement between toll office and toll booth of each toll lane, an underground tunnel across all toll lanes shall be provided. Its dimension would be sufficient to accommodate the required wiring/cable system and for convenient movement of personnel. It should also be provided with lighting and ventilation system so that the movement is convenient. The tunnel shall be of minimum 3 m width and 2.5 m height or alternately suitable safe overhead system of cash transfer may be planned, if required, and same shall be specified in Schedule 'B'.

#### 10.4.6 *Transition*

A transition of 1 in 20 to 1 in 10 may be provided from four-lane section to the widened width at Toll Plaza on either side.

#### 10.4.7 *Canopy*

All the toll lanes and toll booths shall be covered with a canopy. The canopy shall be wide enough to provide weather protection to toll operators, drivers and facilities. The canopy shall be of aesthetically pleasing design with cylindrical support columns located at traffic island so that there is no restriction on visibility and traffic movement. The vertical clearance shall be as prescribed in this Manual.

#### 10.4.8 *Drainage*

The toll plaza shall be provided with surface and sub surface drainage system so that all the storm water is drained off efficiently and no ponding or stagnation of water takes place at any area of the toll plaza.

#### 10.4.9 *Equipment for toll lanes*

Each entry lane shall be equipped with a micro controller based Vehicle Counting-cum-Classifer Unit for counting the number of vehicles and their axle number and for identification of the category of vehicle. The semi-automatic toll collection system shall also have a ticket issuing machine for issue of the tickets for user fee at the press of a button on a touch panel and entry lane controller for controlling the equipment of the entry lane and for sending the data to the data processing equipment at Toll Plaza office. Each toll lane shall have electronically operated boom barrier along with synchronised system for traffic lights.

#### 10.4.10 *Electronic toll collection*

Two lanes in each direction of travel shall be provided with the system of payment through Electronic Toll Collection (ETC) out of which one lane shall be dedicated for ETC exclusively and the second lane shall be standby ETC lane. The standby ETC lane may be converted to dedicated ETC lane in case of failure/maintenance of first ETC lane.

The Tag information shall be read and stored in the dedicated local Server as per the data format given in **Appendix-1**. The ETC transaction data shall be stored securely to avoid any misuse/tampering by any unauthorized persons.

In future, if additional ETC lanes are required to accommodate increased number of Tag users, the Cash lanes shall be converted into dedicated ETC lanes depending upon the ETC usage.

The RFID Transceivers and Tags shall comply with the technical specifications given at **Appendix-1**.

Till the time Legal provision to penalize ETC violations (e.g. Non-Tag or Invalid Tag vehicles entering dedicated ETC lane) is notified, provision of pre-screening of ETC Tags approx 50 – 70 meters prior to lane islands as per the layout plan shown in **Appendix-2** will be made. The objective of ETC pre-screening is to eject the Non-Tag or Invalid Tag vehicles from the ETC lanes to adjacent cash lanes. The ETC pre-screening arrangement would involve installation of RFID Transceiver, a Boom Barrier and related signage.

#### **Nation-wide ETC interoperability**

- i) Till the time Central Clearing House (CCH) is commissioned by the Service Provider for nation-wide interoperable ETC system, the ETC system will be in a stand-alone mode.
- ii) Toll Plaza shall have necessary arrangements for issue, top-up and servicing the RFID Tags complying with the technical specifications indicated in A-I.
- iii) The road users who opt for RFID Tags will get registered with the basic details like Name, Address, Vehicle type, Vehicle registration no., Mobile no. etc. by paying a nominal fee towards cost of the Tag. The Tag users may be charged an initial prepaid amount in multiples of Rs.100/- at the time of registration. In case any Tag holder wishes to discontinue ETC services at any point of time after registration, full balance amount shall be refunded to him.
- iv) When the Central Clearing House (CCH) is commissioned by the Service Provider for nation-wide ETC interoperability, the issuance of Tags shall be stopped by the Concessionaires. The entire database of ETC user account details shall be transferred to NHAI/ETC Service Provider along with the balance amount of ETC Tag holders.
- v) Necessary support shall be provided to ETC Service Provider in migration of ETC accounts from the stand-alone plaza to the Central Clearing House (CCH) for national interoperability. Also, provide all necessary technical support for operation of ETC interoperability. During the interoperable ETC mode, shall support ETC Service Provider in establishing data network between toll plaza and Central Clearing House (CCH) and transfer of ETC data.

#### **10.4.11 Prevention of overloading**

Toll plaza location shall also be provided with system for checking and preventing overloading of vehicles at Toll Plaza. For this purpose, weigh in motion systems at approaches to each toll lane are to be installed. Separate space for static weigh bridge and area to hold off-loaded goods from overloaded vehicles shall be provided after the toll barriers for each direction of travel.

**10.4.12** The total number of toll booths and lanes shall be such as to ensure the service time of not more than 10 second per vehicle at peak flow regardless of methodology adopted for fee collection. For purpose of guidance following parameters are suggested as a capacity of individual toll lane for design purpose :

i)	Semi-automatic toll lane (Automatic vehicle identification but manual fee transaction)	240 veh/hour
ii)	Electronic toll collection (ETC lanes) (Toll collection through RFID Tags and no stoppage of vehicles)	1200 veh/hour

Not less than 2 middle toll lanes shall be capable of being used as reversible lane to meet the demand of tidal flow.

Toll plazas shall be designed for projected peak hour traffic of 20 years. As mentioned in Para 10.4.1, the stage construction of toll plaza in respect of number of toll lanes shall be allowed. If at any time, the queue of vehicles becomes so large that the waiting time of the user exceeds three minutes, the number of toll lanes shall be increased so that the maximum waiting time is brought down to less than three minutes.

#### **10.4.13** *Toll collection system*

For smooth and efficient functioning of toll collection, the following arrangements facilities shall be provided:

- i) The staff posted at the counters in the semi-automatic system of toll collection shall be provided with sufficient electronic equipment for the collection of toll and recording data, and small denomination notes/coins at the start of each shift.
- ii) Intercom facility shall be provided between booths and the office of the supervisors.
- iii) If the booth is closed for any reason, incoming traffic shall be guided into the adjoining working booth with the help of appropriate signs.
- iv) The entire fee collection complex shall be adequately guarded.

#### **10.4.14** *Pavement*

Concrete pavement shall be provided in the Toll Plaza area including tapering zone, from durability and long time serviceability consideration and to permit the provision of toll lanes initially for a projected peak hour traffic of 10 years. The concrete pavement may be widened to provide for future toll lanes required as per stage construction. The rigid pavement shall be designed as per IRC:58. For this work, use of paver shall not be insisted.

#### **10.4.15** *Traffic signs*

A well thought out strategy should be evolved for providing traffic signs and road markings in and around the Toll Plaza in accordance with IRC:67 and IRC:35. The Concessionaire would design the configuration/placement of signs for toll plaza which are not given in IRC:67 and

furnish to IE for review so as to ensure uniformity of signs in use on all the highways across the country.

Signs should be placed along the Project Highway, roadway of Toll Plaza to guide and render assistance to the drivers approaching the Toll Plaza. It is necessary to alert the driver about the existence of Toll Plaza one km ahead with a repeater sign 500 m ahead. Stop sign shall always be used in combination with certain road markings such as stop line and the word 'STOP' marked on the pavement.

The Toll Plaza sign should be supplemented by the sign advising the users of the notified toll rates (fees) for various types of vehicles and exempted categories of vehicles. **Fig.10.3** gives the Direction Information Signs in Toll Plaza.

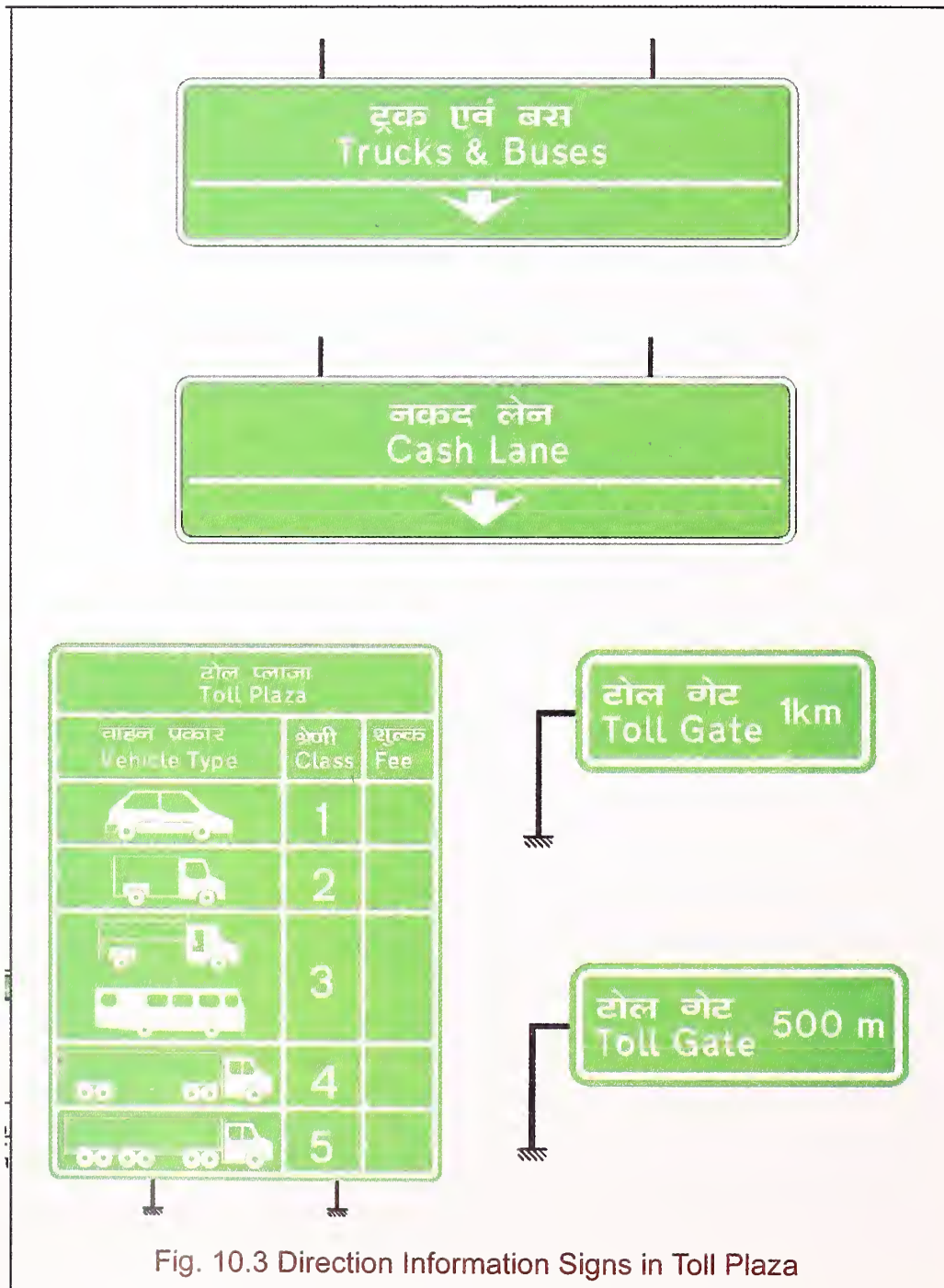

Overhead Lane Signs (OHLS) shall be mounted on the leading edge of the canopy covering the toll lanes above the centre of the lane to indicate to the user. The lane applicable to specific category of vehicle, lane with ETC System, reversible lane, etc. It shall also indicate whether the toll lane is open or closed for the processing of vehicles. A red cross signal would indicate that the lane is closed, whilst a green arrow would indicate that the lane is open to traffic.

#### **10.4.16** *Road markings*

The road markings shall be used in accordance with Section 9 of this Manual. The road markings for the toll plaza area shall consist of lane markings, diagonals, chevron markings. Single centre line is provided at the centre of carriageway at toll gate to demarcate each service lane. Diagonal markings for central traffic island and chevron markings at side traffic island shall be provided to guide the approaching and separating traffic.

In order to check over speeding of the vehicle approaching toll booth, transverse bar markings can be provided. The typical lay out of Plaza building, associate facilities and uploading platforms alongwith transverse and longitudinal markings are shown in **Fig.10.4**.

#### **10.4.17** *Lighting*

The toll plaza shall have lighting system to provide visibility to drivers for the use of facility especially to access the correct service lane and also to the toll collector. Indian Standard 'Code of Practice for Lighting of Public Thorough fare IS:1944 shall be followed . This would be done by interior and exterior lighting as indicated below. Power supply shall be from public power supply system, but stand by generating set of the capacity to supply the required power shall be provided at toll plaza.

**Interior Lighting:** The toll booths and facility building office shall be illuminated adequately. Indoor lighting shall be with fluorescent lamps. Lighting should be provided in such a manner that glare is avoided or minimized. The level of illumination shall be 200 to 300 Lux as per IS:3646 Part II.

**Exterior Lighting:** Lighting of the Toll Plaza is important for enhancing the night visibility. The lighting system shall consist of the following major components.

- i) High Mast lighting
- ii) Lighting on both side approaches to the Toll Plaza
- iii) Canopy lighting of complex

**High Mast Lighting:** Normal low light poles are not able to give the required lighting conditions. It is, therefore, necessary to install high mast. A height of 30 m for the mast is considered suitable to have uniform spread of desired level of illumination in the Toll Plaza area for safe movement of vehicles.

**Highway Lighting:** A minimum requirement of illumination on the road surface of 40 Lux shall be ensured. Lighting in minimum 500 m length on both side approaches of toll plaza (toll booth) shall be provided to enhance the safety at night on the Project Highway and to

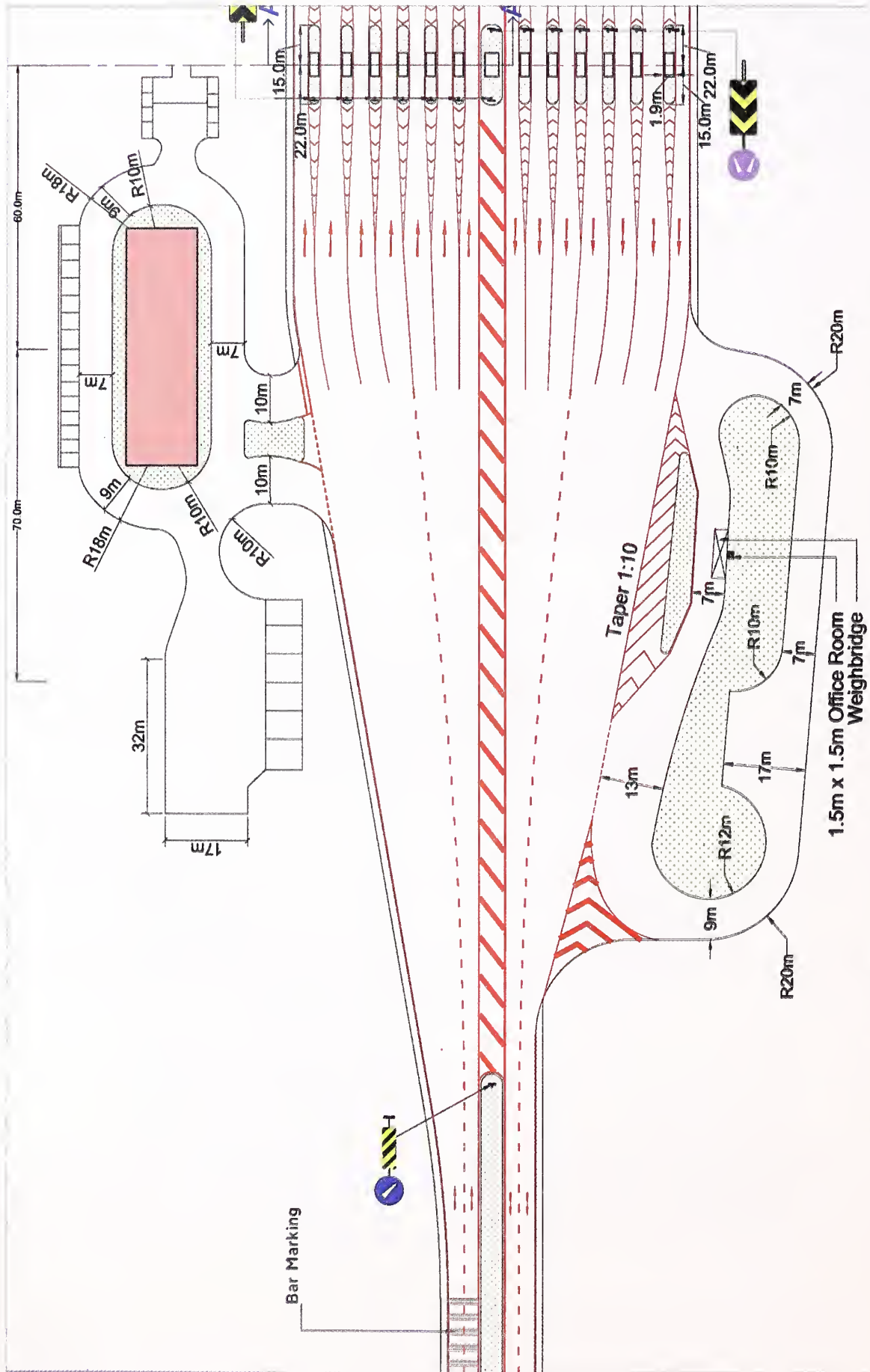

Fig. 10.4 Typical layout Building and Associated Facilities and Pavement Markings



make the drivers conscious of their approaching the toll gate. These shall be provided on the mild steel welded tubular pole of 10m height from road surface and with 2 m overhang. Sodium Vapour lamp of 200-250 watts should be provided for these poles on both sides at 50 m staggered spacing. There should be provision for flashing signals for foggy weather conditions.

**Canopy Lighting:** A higher level of illumination up to 100 Lux by providing 150 watt metal halide lamps shall be provided at the toll gate and at toll booth locations. 1000-watt halogen lamps shall be provided at the selected nodes of space frame of the canopy to ensure uniform illumination of the area.

#### **10.4.18** *Water supply*

Adequate water supply shall be provided. For working out water requirement and internal drainage system, reference may be made to IS:1172, IS:5339 and IS:1742.

#### **10.4.19** *Fire Fighting system*

Toll Plaza shall have fire fighting equipment, including smoke detectors and auto visual alarm system as per Section 4.17.1 of National Building Code, so that the personnel working in the complex and the office and the road users are protected against fire hazards.

#### **10.4.20** *Toll plaza complex*

Toll plaza shall have a separate office building so as to provide comfortable office space for manager, cashier and other staff. There shall be separate rooms for TV monitors, meetings, toilets, and for the sale of passes, smart cards, on board units and public interaction. The building shall have a strong room for keeping the cash and a garage to accommodate the security van (during operation of loading the collected revenue). There shall be parking space in the same campus for vehicles for the staff and workers and other vehicles engaged in the operation of the Project Highway.

The size of the office complex depends on the minimum requirement of above facilities.

Provision for future expansion: The office building shall be located taking into consideration of future expansion.

#### **10.4.21** *Toll audit*

The toll plaza shall have toll audit system and fraud protection measures. The operations for toll collection, supervision, auditing and cash handling shall be done through the qualified personnel with adequate number so that each operation is efficiently handled.

### **10.5 Report to be submitted**

The design and layout of Toll Plaza complex including all facilities shall be submitted to the Independent Engineer for review and comments, if any.

## SECTION – 11

### LANDSCAPING AND TREE PLANTATION

#### 11.1 General

The Concessionaire shall plant trees and shrubs of required number and type at the appropriate locations within the Right of Way and in the land earmarked by the Authority for afforestation keeping in view the IRC Guidelines on Landscaping and Tree Plantation. The Authority shall specify the number of trees which are required to be planted by the Concessionaire as compensatory afforestation or otherwise in Schedule 'C' of Concession Agreement. The Concessionaire shall also maintain the trees and shrubs in good condition during the Concession Period as per the maintenance schedule. The guidelines given in this Section shall be followed in plantation of trees and shrubs.

#### 11.2 Design Considerations in Various Locations

##### 11.2.1 *Set-back distance of trees and other plantation*

Trees on the roadside shall be sufficiently away from the roadway so that they are not a hazard to road traffic or restrict the visibility. Most vulnerable locations in this regard are the inside of curves, medians, junction corners and cut slopes. Trees shall be placed at a minimum distance of 14 m from the centre line of the extreme traffic lane to provide recovery area for the vehicle that runs off the road. A second row of trees 6 m further away will also be planted wherever possible. Preferably the first row of trees shall consist of species with thick shade and other rows of vertical type providing thin shade. Expansion of the Project Highway to 6-lanes shall be taken into consideration while locating the trees so that land is free of trees when further widening takes place. The distances for alternative rows of trees shall be reckoned from the nearest edge of the unidirectional carriageway. No plantation shall be allowed on the embankment slopes.

##### 11.2.2 *Set-back of trees on curves*

Experience has been that growth of thick vegetation close to the formation on inside of horizontal curve leads to serious reduction of sight distance and causes avoidable accidents with cattle/children suddenly emerging from the side. Uncontrolled trees/vegetation, may also affect visibility of traffic control devices and road signs. Therefore, in plain terrain a stopping sight distance of 180 m corresponding to the design speed of 100 km per hour may be ensured on all curved sections of the Project Highway along the innermost lane. However, where there are site restrictions their requirement may be reduced to 130 m corresponding to the design speed of 80 km per hour as a special case. The existing trees and vegetation on the sides have to be suitably thinned/trimmed, or even removed if necessary and a regular programme of pruning of the offending trees shall be undertaken as part of the maintenance operations. In all cases, location of trees shall be checked to ensure that clear vision of all highway signs/signals is available at all times to the motorists. Also, the foliage or trees shall not come in the way of roadway lighting.

### 11.2.3 *Vertical clearance of trees and other plantations*

For safe traffic operation, the vertical clearance available across the roadway shall be minimum 5 m. From this angle, the probable size of all plants shall be anticipated in advance, at the time of initial planting. To allow for the effects of growth, wind and rain, trees shall be trimmed to 6 m and 6.5 m above the pavement in rural and urban areas respectively.

### 11.2.4 *Plantation in medians*

In the sections of the Project Highway where median width is more than 2.5 m, shrubs shall be planted and maintained to cut-off headlight glare from traffic in the opposite direction.

Flowering plants and shrubs are eminently suited for the purpose. These shall be planted either in continuous rows or in the form of baffles. The height of shrubs shall be maintained at 1.5 m to cut-off the effect of traffic lights coming from the opposite direction.

In the sections, where the width of median is less than 2.5 m, shrubs or flowery plants may be planted in between crash barriers or other means like metal/plastic strips to cut off glare shall be provided.

The shape of shrubs and plants shall be suitably regulated so that there is no overgrowth either vertically or horizontally beyond the edge of the median.

In the vicinity of road intersections and median openings, median plantation shall be avoided or restricted to low-growing varieties to ensure adequate visibility.

### 11.2.5 *Spacing of avenue trees*

The spacing of avenue trees will depend on the type and growth characteristics of trees, requirement of maintenance, penetration of distant views, etc. A range of 10-15 m would meet the requirement for most varieties.

### 11.2.6 *Choice of trees*

The following guidelines shall be kept in view while selecting the species of trees to be planted:

- i) Trees shall be selected with due regard to soil, rainfall, temperature and water level
- ii) Trees which become very wide shall be avoided as their maintenance would cause interference with traffic flow.
- iii) The species must be capable of developing a straight and clean bole up to a height of 2.5 to 3.5 m from the ground level.
- iv) The selected trees shall, preferably, be fast growing and wind-firm. These shall not be thorny or drop too many leaves.
- v) The trees shall be deep rooted, as shallow roots injure pavements.
- vi) In urban areas, the species selected shall be of less spreading type, so that these do not interfere with overhead services, clear views of signs/signals, and efficiency of roadway lighting.

### **11.3 Landscape Treatment**

A suitable landscape treatment with provision of foundations and coloured lighting so as to enhance the overall aesthetics duly designed by a qualified and experienced landscaping architect, shall be provided at grade separators, elevated sections, viaducts, traffic islands, toll plazas, bus bays, truck lay byes, rest areas, O&M centre, etc. The locations where landscape treatment is to be given shall be specified in Schedule 'C'. The landscape treatment shall also be provided for special areas as given in IRC:SP:21 (Para 8).

### **11.4 Report to be submitted**

The Concessionaire shall submit scheme for plantation and maintenance of plants and trees to the Independent Engineer for review and comments, if any.

---

## SECTION – 12

### PROJECT FACILITIES

#### 12.1 General

The requirement of the project facilities to be provided shall be indicated in Schedule 'C' of the Concession Agreement. This shall include information regarding location and size of the facilities. Land required for provision of facilities shall be acquired by the Authority and the date of handing over of the land to the Concessionaire shall be indicated in the Concession Agreement.

#### 12.2 Pedestrian Facilities

##### 12.2.1 General

Pedestrians are vulnerable to being involved in accidents. Therefore, adequate consideration shall be given to their safety through provision of facilities. The facilities for pedestrians given in this Section shall be provided on the Project Highway.

##### 12.2.2 Footpaths (sidewalks)

- i) The sidewalks shall be provided in the built-up sections, on both sides, as given in Para 2.15 of this Manual.
- ii) The width of sidewalks depends upon the expected pedestrian flow and shall be fixed subject to land availability, but shall not be less than 1.5 m.

##### 12.2.3 Pedestrian guard rails

Pedestrian guardrails shall be provided as specified in Section 9 of this Manual.

##### 12.2.4 Pedestrian crossings

There shall be no pedestrian crossings across the carriageway. Facility for crossing the carriageway by the pedestrians shall be provided through pedestrian underpasses/FOB as per Para 2.13.4 of this Manual. At-grade pedestrian crossings shall be provided for all intersections of cross roads with service roads or entry exit ramps. At-grade pedestrian crossings shall be controlled. Controlled form of crossing shall be achieved through provision of Zebra Crossings, whether at signalized intersection or pedestrian actuated signal.

#### 12.3 Street Lighting

##### 12.3.1 General

- i) The Concessionaire shall provide lighting at locations of the Project Highway specified in Schedule 'C', using appropriate system and source of electric power as per the requirements of this Section.
- ii) The Concessionaire shall make suitable arrangements for procuring power supply to ensure uninterrupted lighting during night and when visibility is low, including provision of DG sets as standby arrangements.

- iii) The Concessionaire shall bear all costs of procurement, installation, running and operation cost of all lighting, including cost of energy consumption specified in this Section.

### **12.3.2** *Specifications*

- i) Unless stated otherwise in this Manual, the minimum level of illumination on the locations of the Project Highway where lighting is to be provided as per this section shall be 40 Lux.
- ii) The layout of the lighting system together with type of luminaries for different locations shall be prepared by the Concessionaire in such a manner that the minimum illumination level prescribed in Para 12.3.2(i) can be achieved and shall be submitted to the Independent Engineer for review and comments, if any, for compliance by the Concessionaire.
- iii) Overhead electrical power and telecommunication lines erected within the ROW by the Concessionaire shall be provided with adequate clearance so that safe use of the highway is not affected.
- iv) Vertical and horizontal clearances for electrical installations shall conform to IRC:32.
- v) All the fixtures, wires/cables, lights shall conform to relevant BIS specifications as a minimum. The Concessionaire with the prior review and comments of the Independent Engineer can use fixtures with better specifications.

### **12.3.3** *Locations where lighting is to be provided*

Unless specified otherwise in Schedule 'C' of the Concession Agreement and else as per in this Manual, the Concessionaire shall provide lighting at the following locations of the Project Highway:

- i) Toll Plaza Area: The lighting in and around Toll Plaza, toll booths, office building, on the approach road, etc. shall be as per Section 10 of this Manual.
- ii) Rest Areas as given in Para 12.6
- iii) Truck lay-bye: Lighting at the truck lay-bye shall be as per Para 12.4.
- iv) Bus Bay & Bus Shelter Locations: Lighting shall be provided as per Para 12.5.
- v) Grade separated Structures, Interchanges, Flyovers, Underpasses (vehicular/pedestrian) and Overpasses: Lighting shall be provided as per Para 3.3.4 of this Manual.
- vi) Built-up sections on the Project Highway both in the median of main carriageway and on the service roads on either side.

## **12.4** **Truck Lay-byes**

### **12.4.1** *General*

The Concessionaire shall construct and maintain adequate number and size of truck lay-bye for parking of trucks by the side of the Project Highway as indicated in Schedule 'C' of the

Concession Agreement. The guidelines, as given here, shall be followed in regard to location, size and facilities to be provided at the truck lay-byes. A typical lay out is given in **Fig. 12.1**.

#### **12.4.2**     *Location and size*

Truck lay-byes shall, in general, be located near check barriers, interstate borders, places of conventional stops of the truck operators, etc. The places be identified on the basis of field survey and shall have adequate space for facilities as specified in this section and future growth.

#### **12.4.3**     *Facilities*

The truck lay-byes shall have the following facilities:

- i)     Paved parking,
- ii)    Rest areas with toilets, drinking water,
- iii)   Telephone.

#### **12.4.4**     *Lighting*

The truck lay-byes and 50 m length of the Project Highway on its either side shall be illuminated at night to provide a minimum illumination of 40 Lux. Suitably designed electric poles having aesthetic appeal and energy saving bulbs may be used to provide required illumination. Alternatively, photo voltaic lamps may be used.

### **12.5**        **Bus Bays and Passenger Shelters**

#### **12.5.1**     *General*

The buses shall be allowed to stop for dropping and picking up passengers only at the bus bays, which shall be provided near the pedestrian underpass overpass locations. The Authority will indicate in Schedule 'C' of the Concession Agreement, the number and broad location of bus bays to be provided by the Concessionaire. The bus bays shall conform to the specifications and standards given in this Section.

#### **12.5.2**     *Location*

The bus bays shall be located only near the pedestrian underpass overpass locations. In hilly areas, the bus bays shall be located, preferably, where the road is straight on both sides, gradients are flat and the visibility is reasonably good (usually not less than 50 m). Subject to these requirements, it will be advisable to choose locations where it is possible to widen the roadway economically for accommodating bus bays.

#### **12.5.3**     *Layout and design*

- i)     For plain area, typical/layouts of bus bays given in **Fig. 12.2** shall be adopted. The length "L" shown in **Fig. 12.1** shall be 15 m. which shall be increased in multiples of 15 m if more than one bus is likely to halt at the bus bay at one time.
- ii)    For hilly areas, where there is a general constraint on space, the layout indicated in **Fig. 12.3** may be adopted.

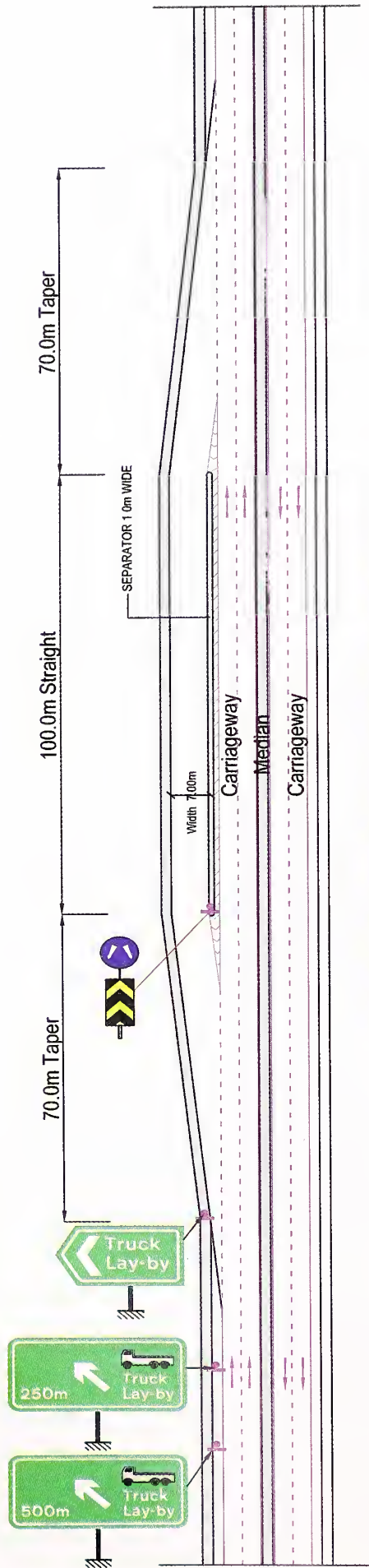

Fig. 12.1 Typical layout of Truck Lay By

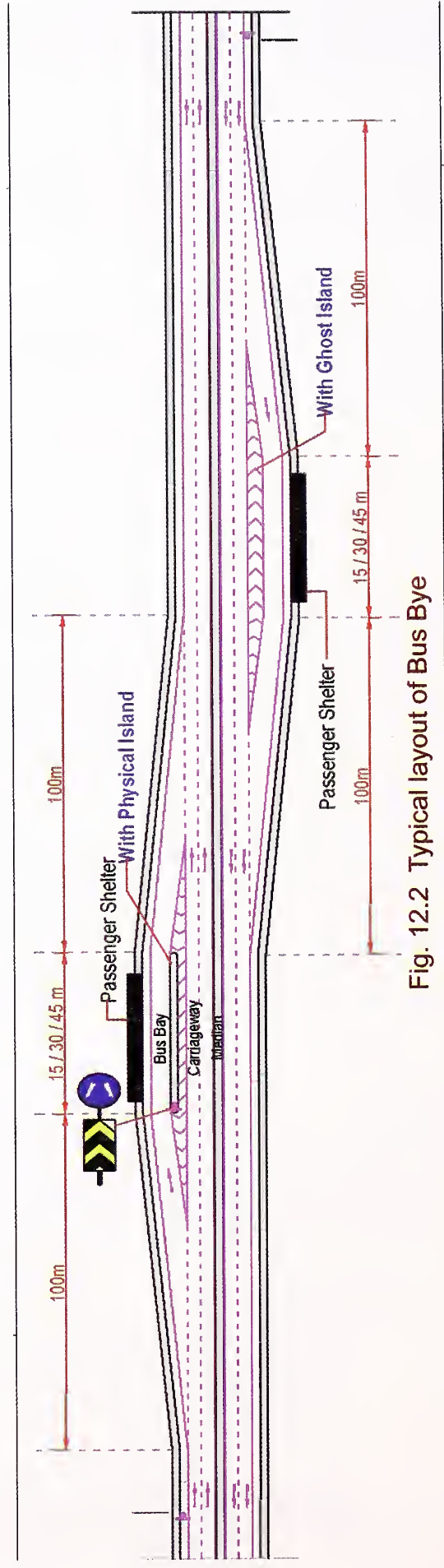

Fig. 12.2 Typical layout of Bus Bay



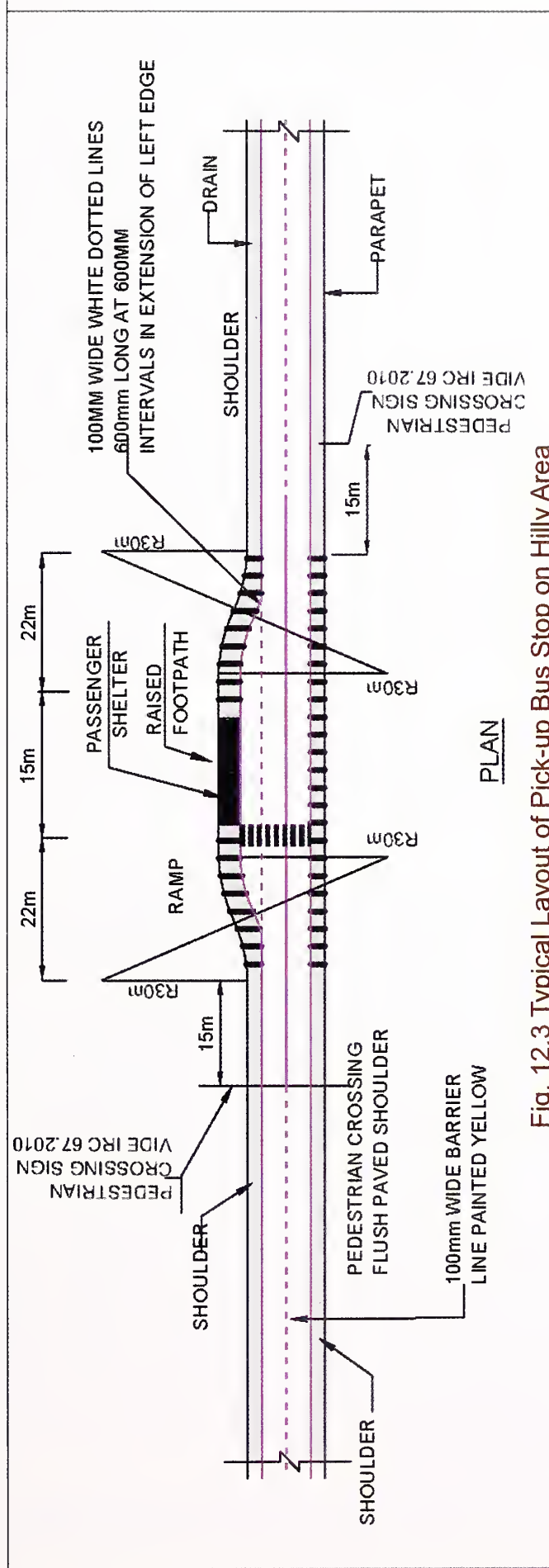

Fig. 12.3 Typical Layout of Pick-up Bus Stop on Hilly Area

- iii) The channellizing island between the paved shoulder and bus-bay shall not be raised but it shall be paved with CC blocks.
- iv) Bus bays shall be provided on both sides of the Project Highway for each direction of travel independently. Covered steps with rise not exceeding 150 mm (minimum 5 m wide) along with a ramp for use of disabled persons (1 m wide minimum) with railing on either side shall be provided for climbing up/down from Bus Shelter to underpass/overpass to carriageway and vice versa. The cover of the steps shall be aesthetically pleasing and protect the users from sun, wind and rain. The entire area used by the pedestrians shall be provided with granite stone cladding and flooring.
- v) The bus bay shall be provided with a shelter for passengers. The shelter shall be structurally safe and aesthetic in appearance, while also being functional so as to protect the waiting passengers adequately from sun, wind and rain. If the shelter is constructed on the till side, slopes shall be properly dressed and suitably protected to avoid slips.
- vi) The bus bay and passenger shelter shall be designed to provide for safe and convenient use by physically challenged persons as well.

#### 12.5.4 *Pavement*

The pavement in the bus bays shall have adequate crust with respect to the wheel loads expected. Also, the surfacing shall be strong enough to withstand forces due to frequent braking and acceleration by the buses.

#### 12.5.5 *Drainage*

- i) The bus bays shall have proper cross slope to drain off the excess water. No water, which is likely to splash on the waiting passengers, shall be allowed to collect near the bus shelters.
- ii) Suitable kerb gutter section with requisite longitudinal slope and outlets at intervals to ensure quick disposal of water shall be provided.
- iii) Adequate drainage for the steps and pedestrian movement area shall be provided.

#### 12.5.6 *Road markings*

Pavement markings as specified in Section 9 of this Manual shall be provided at the bus stops as shown in **Figs. 12.2** and **12.3** with the word 'BUS' written prominently on the pavement. Pedestrian crossings shall be marked slightly behind the standing position of the buses in order to reduce pedestrian conflicts. The kerbs shall be marked with continuous yellow line to indicate "No Parking".

#### 12.5.7 *Landscaping and plantation*

The total area of ROW near the bus bay location shall be landscaped and planted with shady trees for giving pleasing appearance of the area.

### 12.5.8 *Lighting*

The entire bus bay area shall be provided with lighting (minimum illumination of 40 Lux)

## 12.6 **Rest Areas**

**12.6.1** The rest areas shall be provided at the locations given in Schedule 'C'. Rest areas shall be provided by the Concessionaire on the lands included in the site and procured by the Authority. Within the areas so provided, the Concessionaire shall construct and operate, or cause to be constructed and operated, facilities such as toilets, telephones, cafeteria, restaurant, parking for cars, buses and trucks, dormitory, rest rooms, shops for travel needs, fuel stations and garage, first aid, etc. In approximately 2 Hectares of land, the following minimum facilities shall be provided.

Cafeteria/Restaurant for seating 50 persons; Toilets (separate for ladies and gents) (WC - 5 nos.; Urinals - 10 nos.); Dormitory with 20 beds; drinking water facility; parking for 100 trucks and 50 cars in addition to STD/ISD Telephone Facility, Shops and First Aid facilities.

The facilities shall be provided keeping in view the expected peak hour traffic.

The whole area shall be elaborately landscaped to provide a pleasing environment.

**12.6.2** Lighting shall be provided as given in Para 12.4.4.

## 12.7 **Cattle Crossings**

Facility for cattle crossings shall be provided as specified in Para 2.13.4.

## 12.8 **Highway Patrol Unit(s)**

The Concessionaire shall establish and operate Highway Patrol Unit(s) at the Toll Plaza Locations, which shall continuously patrol the highway in a stretch not exceeding 50 km and shall remain in contact with the Control Room on a real time basis. The patrol shall render assistance to users in distress and disabled vehicles through own intervention or by calling for assistance from Control Room, Crane operators or ambulance as required. The patrol shall promptly clear the road of any obstruction. Where the obstructions take time to be cleared, the section shall be cordoned off by placing traffic cones, which shall be illuminated during night. The patrol vehicle shall be large enough for seating atleast four personnel besides the driver and space to carry essential traffic and incidence management and safety tools. It Shall also have a light on its top and a siren on board. It shall also be filled with a GPS based Vehicle Tracking System to monitor its movement on 24 hrs x 7 days of a week basis.

Each Patrol Vehicle should carry the following equipment:

- a) Fire extinguisher (1 no.)
- b) Gas culler with protective glass (2 nos.)
- c) Liquid container (2 nos.), Water container with fresh water (1 no.) and Funnel.
- d) Rubber Gloves, Leather Gloves (1 pair each)
- e) Brooms one hard bristle, other soft (2 nos.)

- f) Gum boot (4 pairs), Rain coat (4 pairs), Blanket (1 no.)
- g) Torch light (4 nos), Spare Batteries, Flashing light (1 no.)
- h) Hydraulic jack, towing chain, Animal hook, rope.
- i) Tool set (with standard set of spanners, pliers, hammers etc), shovels.
- j) Digital Camera, measuring tape.
- k) Paper pad, Forms, pens/pencils, folders.
- l) First Aid kit, Rain Coat, water proof sheets, stretchers (2 nos.)
- m) List of Hospitals in the area.

Each vehicle should also carry the following Traffic Management Equipment, (used/worn out items shall be replaced forthwith with new ones)

- a) Sign boards - "Accident ahead" - 3 nos., "Lane merging" - 3 nos., "Direction Arrows" - 3 nos., "Speed Limit" (80/60/40) - 3 nos., "Keep left/right" - 2 nos. (all signs 1200 mm size and of retro-reflective type (micro prismatic cube comer).
- b) Sign Stand set (one for triangular and other for circular sign)-6 sets.
- c) Flags, whistle, reflective hand signal.
- d) Traffic cones 500 mm size with solar bulb mounted on top. 20 nos.
- e) Barricades-4 nos. reflective type (100 m), tape, stands, flags of 600 mm by 600 mm made of good red cloth secured to a staff at 1m length, paddles all east 600 mm wide and provided with rigid handle with markings SLOW, STOP.

Reflective Jackets - 12 nos.

As a minimum, each patrol vehicle should carry sufficient communication equipment to render its staff capable of direct communication with the Control Room.

### **Manpower:**

The team which is to be deployed with each patrol vehicle, needs adequate training for their tasks, especially in first aid, vehicle maintenance and minor repairs. The Concessionaire must employ sufficient manpower to work in shifts for each patrol vehicle. Typical staffing shall be:

- a) Route Patrol Incharge
- b) Route Patrol Assistant
- c) Driver, with knowledge of vehicle repairs.

## **12.9 Emergency Medical Services**

These services shall include setting up medical aid posts by the Concessionaire. The Concessionaire shall provide ambulance(s) at the Toll Plaza location(s) manned by atleast two trained and certified paramedics so that the response time is not more than 20 minutes of call. Each ambulance shall be equipped with first aid, life saving medical services and

support system implements for transporting the victims to the nearest trauma care hospitals, and providing emergency medical aid during transportation of victims from accident site to the nearest trauma care hospital. It shall also be fitted with a GPS based Vehicle Tracking System to monitor its movement on 24 hrs x 7 days of a week basis.

The vehicle shall be conform to AIS 125 : Constructional and Fuctional Requirement for Road Ambulances (National Ambulance Code) published by MORTH. The ambulance is required to have the following medicines and equipments and also the paramedical staff:

a) **General Ambulance**

Folding Doctor Seat with Belt with adequate height in relation to the stretcher, Antistatic, water proof ply board vinyl flooring, Channel, Locking system for rolling stretcher, High intensity blinkers/light barsiren/beacon, Electronic siren with Public Addressing System, Internal lighting with three spot light embedded in ceiling, AC/DC connection and outlet points, Wash basin with Stainless Steel Tank, 58 Trash bin Cabinet integrated with interiors, Head racks and cupboard, Attendant seat with seat belt to double as second stretcher for stable patients, Provision for communication system where the location of ambulance can be located, Provision for fog light on sides, Cool/Warm boxes, Provision of Fire Extinguishers, Handheld Spotlight,

Inverter with the facility re-charging from 220V AC and Vehicle's alternative, Oxygen delivery system comprising of Cylinder Trolley, pressure tubing with regulators, Roof mounted Air-conditioner with appropriate cooling capacity with additional blower for Patient Cabin, Extrication equipment and Good Suspension to cater for smooth transportation.

b) **Basic Life Support System**

Automatic loading stretcher, Scoop stretcher, Folding stretcher, Spineboard full, Vacuum splint kit/foldable splints, C-Collars, Oxygen Cylinder with accessories mounted/with manifold and pressure indicators, Oxygen Cylinder (aluminium portable), BP Instruments (Wall mounted-Aneroid), Stethoscope, Automatic defibrillator, Resuscitation bag (ambu bag, laryngoscope, airways and masks of different size including pediatric). Manual foot operated suction pump. I. V. Fluid and I.V. Sets, Tourniquet, First Aid Box (Dressing material/Antiseptic lotion/Analgesic etc), Linen/Blanket, Laryngeal mask airway of all sizes.

c) The following paramedical staff are required with proper uniform and name of the person written on the uniform:

- |      |   |   |
|------|---|---|
| i)   | Trained Paramedical Staff                 | 1 |
| ii)  | Nursing staff with knowledge of first aid | 1 |
| iii) | Driver for ambulance                      | 1 |

## 12.10 Crane Services

The Concessionaire shall provide a crane of adequate capacity (minimum 20 MT) at each Toll plaza location (s) with all necessary equipment so that it can reach the site of the incident

within 30 minutes of call and clear the disabled/accidented vehicles. It shall also be fitted with a GPS based Vehicle Tracking system to monitor its movement on 24 hours x 7 days of a week basis.

### **12.11 Communication System**

The Concessionaire shall provide a suitable Communication System with all necessary equipment for meeting his O&M obligations.

### **12.12 Advanced Traffic Management Systems (ATMS)**

For ATMS, Clauses 816.1 to 816.17 of Specifications for Road and Bridge Works of MORTH shall be applicable.

### **12.13 Operation and Maintenance Centre**

**12.13.1** There shall be operation and maintenance centre(s) either at the toll plaza (s) or at any other location along the Project Highway as identified by the Concessionaire. The land for the same shall be acquired by the Concessionaire at his cost and risk. The operation and maintenance centre would have following minimum facilities:

- i) Main control centre and Administrative block.
- ii) Equipment for operation and maintenance and storage space for them.
- iii) Storage space for equipment and material for traffic signs and markings.
- iv) Workshop.
- v) General garage and repair shop.
- vi) Testing laboratory.
- vii) Parking space for minimum 4 number of large vehicles and for other expected vehicle during peak hours including those for working staff and visitors.

**12.13.2** All building works shall be designed to meet the functional requirements and shall be compatible with regional architecture and micro climate. Locally available materials shall be given preference but not at the cost of construction quality.

**12.13.3** The circulation roads and parking spaces in the O&M centre shall be paved to withstand vehicle loads and forces due to frequent acceleration and braking of vehicles.

Parking bays/lots shall have proper cross slope and drainage. The marking of the parking bays shall be as per IRC:35 to demarcate parking and circulation space. Parking lots shall have illumination as provided in IS:1944 (Parts I and II).

**12.13.4** The whole campus of operation and maintenance centre shall have system for security with safe entry and exit.

### **12.14 Report to be submitted**

The Concessionaire shall submit report containing the proposals for provision of project facilities on the Project Highway to the IE for review and comments, if any.

## SECTION – 13

### SPECIAL REQUIREMENTS FOR HILL ROADS

#### 13.1 General

**13.1.1** The additional/new carriageway in hilly areas may either be constructed at the same level as that of the existing carriageway or at different levels to form a split highway depending upon the feasibility and geo-technical stability of the area.

**13.1.2** The Concessionaire shall pay due attention to geo-technical, environmental and social aspects of hill roads and take appropriate measures to ensure the following: (The guidelines given in IRC:SP:48 may be referred to for details).

- i) Stability against geological disturbances.
- ii) Prevention of soil erosion.
- iii) Provision of efficient drainage and preservation of natural drainage system.

**13.1.3** If there are any landslide prone areas along the road alignment, adequate investigation shall be undertaken and appropriate remedial measures shall be provided as per guidelines given in IRC:SP:48.

**13.1.4** Where any new construction/realignment is involved, the alignment shall avoid large scale cutting and filling and follow the profile of land, as far as possible.

Areas having potential landslide or settlement problems shall be avoided. Adverse impact on the environment shall be reduced by adopting proper mitigation measures. Refer to guidelines given in IRC:SP:48.

**13.1.5** Unstable hill slopes shall be adequately addressed by providing appropriate bioengineering and stabilization measures.

**13.1.6** Necessary safeguard shall be taken to protect ecologically sensitive areas like wild life and bird sanctuaries, reserve forests, national parks, etc.

**13.1.7** Protective structures for traffic such as parapets, railings, roadside safety barriers, boulder nets, etc. shall be provided, where necessary.

**13.1.8** In mountainous and steep terrain, the scope of work defined by the Authority may be two-lane carriageways on different alignments (contours). In that case, the Manual of Specifications and Standards for two-laning of Highways shall apply to the two-lane carriageways on different alignments (contours).

#### 13.2 Set Back Distance at Horizontal Curves

Requisite sight distance should be available across the inside of horizontal curves. Lack of visibility in the lateral direction may arise due to obstructions like walls, cut-slopes, wooded areas, etc. Set back distance from the central line of the carriageway, within which the offending obstructions should be cleared to ensure the needed visibility, can be determined using the Equation given in IRC:52.

### **13.3 Grade Compensation at Curves**

At horizontal curves, the gradient shall be eased by applying the grade compensation correction for gradients steeper than 4 percent in accordance with IRC:52.

### **13.4 Hairpin Bends**

Hairpin bends, where unavoidable, may be designed either as a circular curve with transition curves at each end or as a compound circular curve.

Design criteria given in IRC:52 shall be adopted for the design of hairpin bends. At hairpin bends, the full roadway width shall be surfaced.

### **13.5 Climbing Lane**

Climbing lane shall be provided, where specified in Schedule 'B' of the Concession Agreement, in order to address the necessity of making available separate lane for safe overtaking for vehicle traveling uphill.

Proper signs and road markings shall be provided to ensure that the absolute right of way for climbing vehicles is available.

### **13.6 Rock Blasting**

Heavy rock blasting should be avoided. Controlled blasting shall be resorted to. Blasting shall be supervised by experienced personnel. Blasting and related operations shall be carried out in accordance with Clause 302 of MORTH Specifications.

### **13.7 Cut Slopes**

Cut slopes shall be rendered stable in the construction stage itself, by cutting at the correct angle and benching etc. including slope stabilizing structures like drains, breast walls, pitching, etc.

### **13.8 Tunnels**

Where it is necessary to cross hills or high ridges, the various alternatives including construction of tunnel to avoid deep cuts shall be considered and the most preferred alternative shall be chosen. The alternative to be followed shall be indicated in Schedule 'B' of the Concession Agreement. Where road is to be taken through tunnel, its salient details shall be indicated in Schedule 'B' of the Concession Agreement. Alternatively the specifications given in Section 14 of this Manual shall be adopted.

### **13.9 Drainage**

For drainage of water from roadside, an effective system of drainage shall be constructed to lead the run-off to natural water courses. In particular, catch water drains (Refer to Para 6.5 of this Manual) shall be provided above the cut slopes. It shall be ensured that water is not drained into villages and cultivated land. Location of cross drains and culverts should be so chosen as to avoid erosion of the outlet. Erosion control works like drop walls, apron at out-fall points along with pitching/paving of the channel shall be provided where required.



## **13.10 Retaining Walls**

### **13.10.1** *Retaining walls shall be provided*

- i) To support the down hill side unstable strata or fills,
- ii) To achieve width of roadway, where cutting into hill is restricted,
- iii) To arrest damage caused to the valley side and the road, by undercutting by a stream or other water course,
- iv) At valley points, where water flows over the road,
- v) At places where the valley side gets saturated in the monsoons and is likely to result in slips and damage to the road,
- vi) At any other locations warranting provision of retaining walls.

**13.10.2** The retaining walls on the existing roads shall be inspected by the Concessionaire to check and assess the requirements of repairs and/or strengthening or reconstruction. If so required, the repair and/or strengthening or reconstruction work shall be carried out as per the assessment.

**13.10.3** For general features, arrangement and design, guidelines given in IRC:SP:48 may be referred to.

## **13.11 Aprons etc.**

Construction of apron, pitching, flooring shall conform to Clauses 2503 to 2507 of MORTH Specifications.

## **13.12 Disposal of Debris**

Disposal sites shall be identified by the Concessionaire for disposal of waste, debris, etc. Tipping of waste into valley sides, stream channels, water bodies, and forest areas shall not be resorted to.

## **13.13 Report to be Submitted**

The Concessionaire shall submit report containing proposal for special requirements in hill areas to the IE for review and comments, if any.

## SECTION – 14

### TUNNELS

#### 14.1 General

**14.1.1** Project highway shall be constructed in tunnel either to carry the alignment under or through a natural obstacle or to minimize the impact on the community under conditions such as:

- i) Long, narrow mountainous terrain where a cut section is economically unviable or leads to adverse environmental consequences.
- ii) Narrow right-of-way where all the surface area must be retained for road purpose.
- iii) Railway yard, airport or similar facilities.
- iv) Parks or other land uses, existing or planned.
- v) Prohibitive costs of land acquisition exceeding the costs of tunnel construction and operation.

**14.1.2** Planning and design of tunnel shall be based on various conditions along the Project highway alignment including the topography, geology, meteorology, environment, locations and traffic volumes and shall generally conform to provisions of IRC:SP:91 and this Manual.

**14.1.3** Wherever tunnel is required to be provided its location, length and number of lanes shall be indicated in Schedule 'B' of the Concession Agreement.

#### 14.2 Geometrics

**14.2.1** A tunnel shall have the same geometric standards as on the main carriageway outside the tunnel except as specified in this Section.

##### 14.2.2 *Cross-section*

Shape of tunnel cross-section shall be commensurate with the methodology of construction, e.g., mining or cut-and-cover method, geotechnical conditions and structural consideration.

##### 14.2.3 *Horizontal clearance*

The tunnel shall cater for carriageway, paved shoulder, edge strip as on the adjoining carriageways outside the tunnel, and space to be provided for ventilation ducts, escape footway, emergency lay-bye where necessary, lighting, drainage, fire and other services.

##### 14.2.4 *Vertical clearance*

The tunnel shall have a minimum vertical clearance of 5.0 m over the full width of carriageway and paved shoulders. Vertical clearance over footway shall be 3.0 m minimum. Additional vertical clearance shall be provided for accommodating tunnel ventilation and lighting fixtures.

#### 14.2.5 *Number of traffic lanes*

Design service volume for tunnel shall be same as for the portion of highway outside the tunnel. Number of lanes to be provided shall be based on the traffic projections for 25 years. Tunnels shall have minimum 3-lanes carriageway for each direction of traffic. Provision shall be made for providing additional tubes as and when traffic demands. In case there is existing 2-lane tunnel, another 2-lane tunnel shall be added for one side traffic (2x2 lanes) and a new 3-lane tunnel shall be added for other side of traffic. In case there are two existing tunnels of 2-lanes each another tunnel of 3-lane or two tunnels of 2-lanes each shall be added.

#### 14.2.6 *Carriageway & paved shoulder*

The carriageways of the tunnels shall be of cement concrete. Tunnels shall have paved shoulder of 2.0 m on left side and edge strip of 0.60 m on the right side. In case of tunnels having more than 500 m length provision shall be made for 100 m long and 3.0 m wide emergency lay bye beyond the left most lane at 750 m intervals to facilitate refuge by break down/damaged vehicles and also for maintenance vehicles. Proper transitions, line of sight and informatory signs shall be ensured for such lay-bye.

Typical tunnel cross sections for unidirectional traffic conditions for three-lane configuration with cut and cover construction and mining type construction are shown in **Figs. 14.1** and **14.2**. A typical layout of lay-bye is shown in **Fig. 14.3**.

#### 14.2.7 *Tunnel spacing*

The clear distance between the twin tubes shall be kept depending upon the type of strata and structural stability of the tunnel subject.

#### 14.2.8 *Tunnel passage*

The twin tunnels of more than 500 m length shall be connected by a cross passage at an inclination to facilitate diversion of the traffic from one tube to other tube in the event of an incident/accident in one of the tubes at a spacing of 300 m. The cross passage shall be at an angle of 30 degrees with the direction of flow as shown in **Fig. 14.4**. The cross passage shall have provision for one traffic lane, edge strip of 0.60 m, crash barriers and walkways on either side. In normal conditions the cross passage shall be barricaded.

#### 14.2.9 *Vertical alignment*

The vertical gradient shall not be more than 2.5 percent for tunnels of length more than 500 m. In short tunnels the gradient may be limited to 6 percent however, in such cases the ventilation system should be designed to take effect of gradient and possible incidence of fire.

#### 14.2.10 *Horizontal alignment*

The horizontal alignment shall be straight as far as practicable. However the straight stretch shall not be more than 1500 m to avoid the effect of monotony and induction of an unconscious increase in speed. Similarly, last few metres of the tunnel shall have gentle curve. The curves if provided shall be gentle and meet the minimum radius requirements for design speed of the tunnel. Tunnel alignment at the ends and open/approach cuts shall merge smoothly

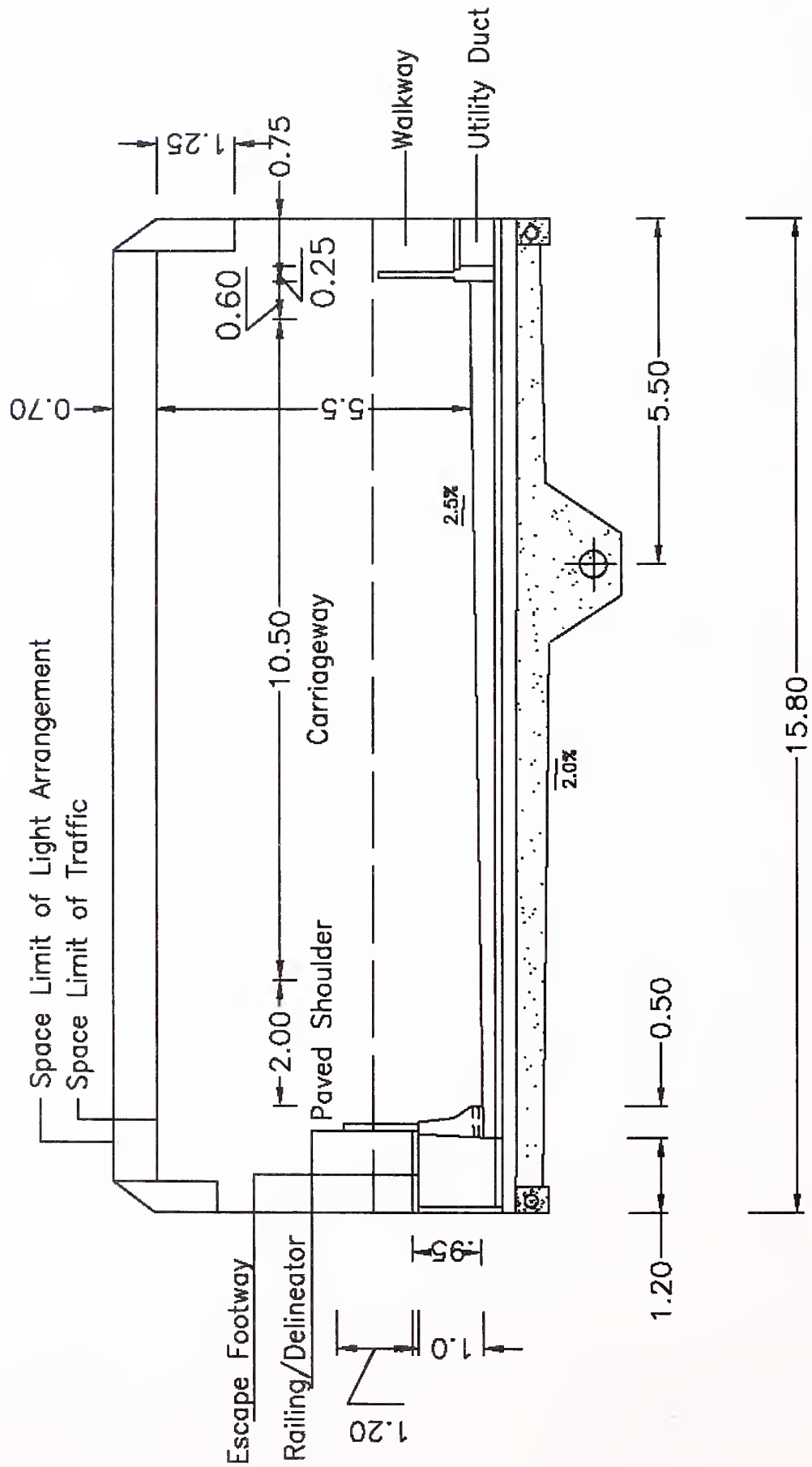

Fig. 14.1 Typical Cross-section of Three Lane Tunnel Cut and Cover Construction

NOTE - All Dimesion are in metres

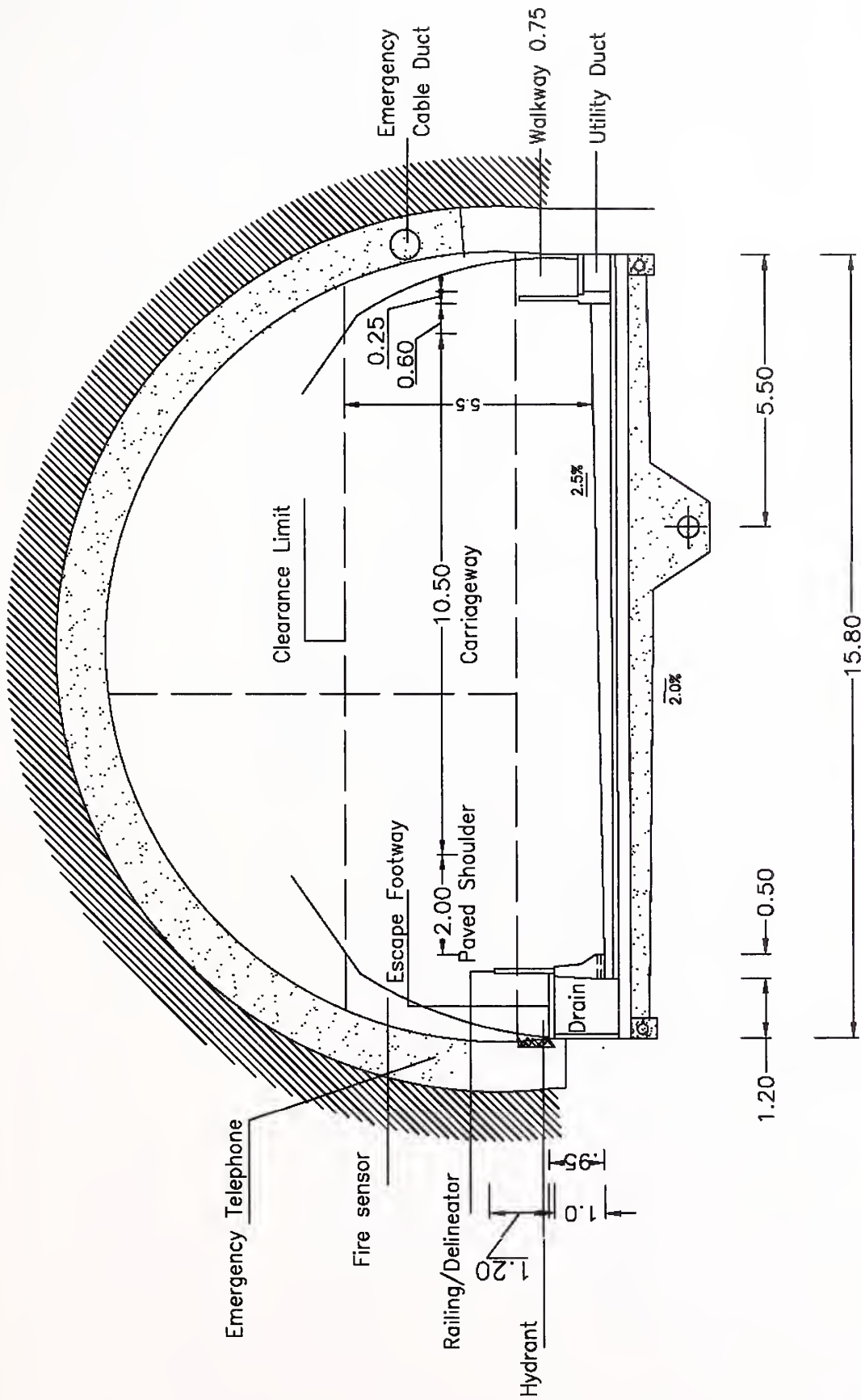

Fig. 14.2 Typical Cross-section of Three Lane Tunnel Mining Type Construction

NOTE - All Dimesion are in metres

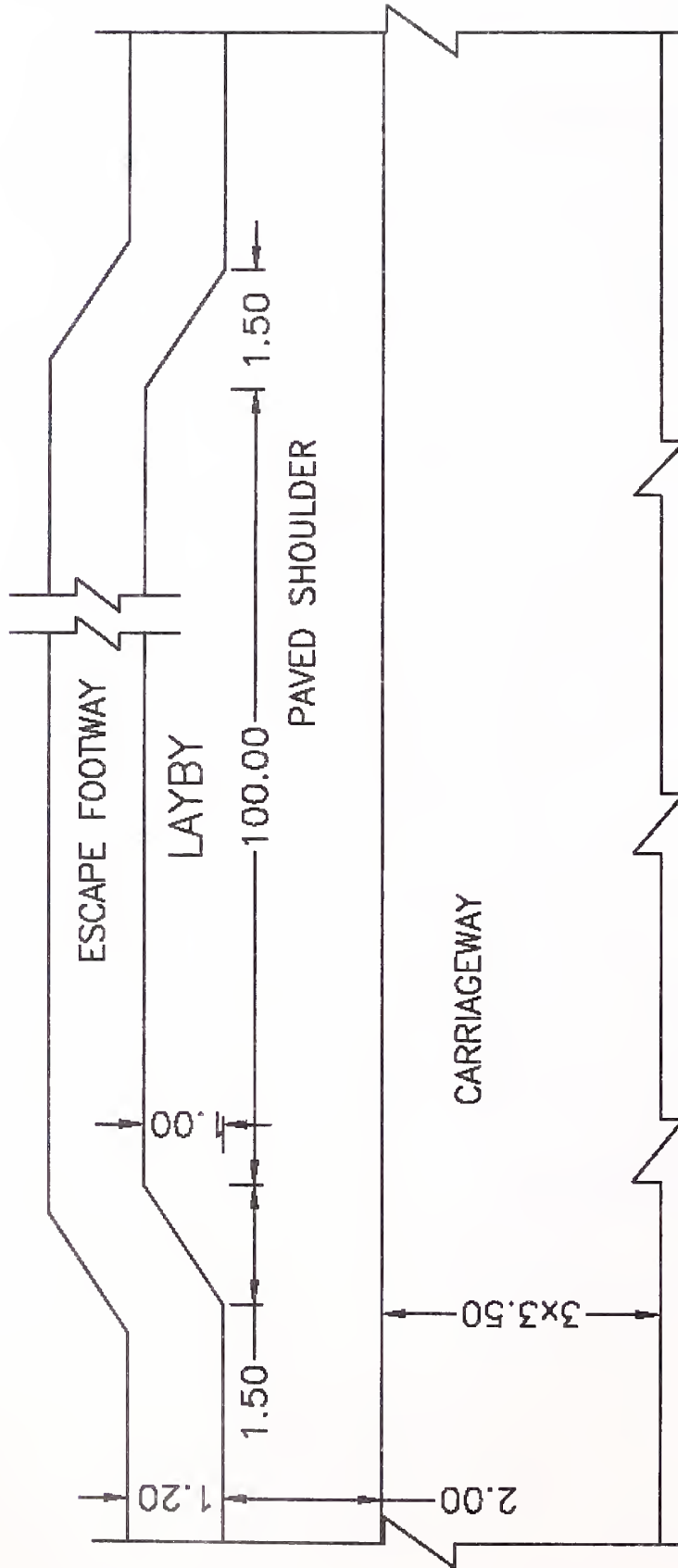
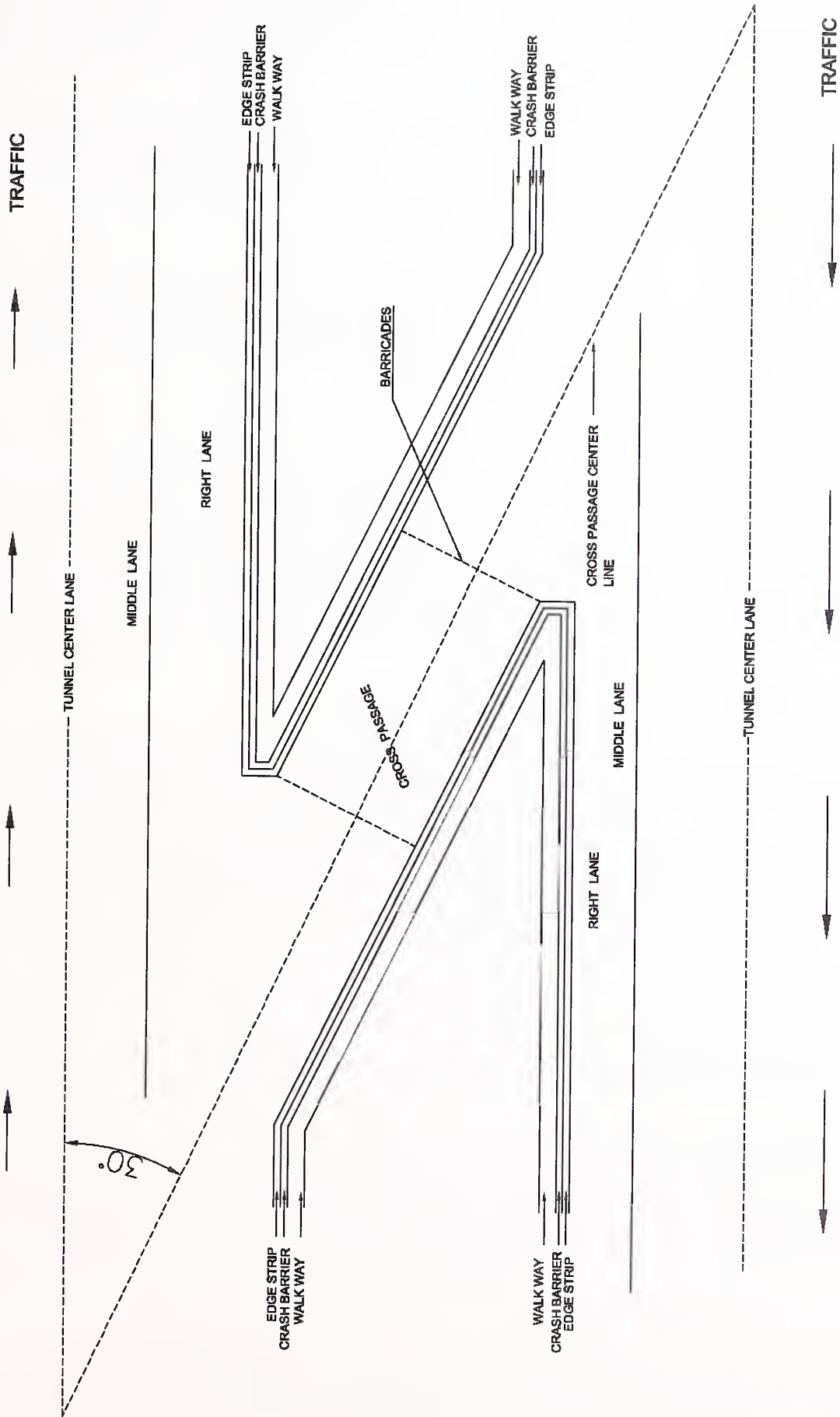

Fig. 14.3 Typical Layby Inside Tunnel For Tunnels Length More Than 500 M  
(At 750 m Interval)

NOTE - All Dimesion are in metres



PLAN

Fig. 14.4 Tunnel Passage

with adjoining road in the open air. The crossing of central median shall be provided at suitable locations at approaches of both tunnel tubes so as to allow emergency services gain immediate access to either tube and also to send back diverted traffic to proper traffic lanes.

#### **14.2.11** *Tunnel approach*

Tunnel approach shall have smoothly aligned tunnel walls without any sudden narrowing to avoid a shift from the tunnel wall and a good day/night visibility of the edge lines. Tunnel wall lining shall be of white colour with high luminous reflectance.

#### **14.2.12** *Tunnel portals*

Tunnel portals should, apart from providing protection at entry and exit, convey drivers about the presence of the tunnel, reduce the luminance of facing walls and be in harmony with the surrounding environment from aesthetics considerations.

### **14.3 Geotechnical Investigations**

In order to make a realistic geotechnical and geophysical assessment of the ground through which the tunnel is to pass and detailed mapping of surface geology of the tunnel area necessary for the planning and design of alignment and portal locations, shape of tunnel, tunnel supporting systems, minimum distance to be kept between two tunnels, independent geotechnical investigations should be carried in accordance with the provisions of Section 3 of IRC:SP:91.

### **14.4 Structural Design**

**14.4.1** Assessment of applicable loads shall be based on structural properties of the ground likely to be met during tunneling as arrived from detailed geo-technical investigations.

**14.4.2** The design shall cater to the most adverse combination of load conditions including only those loads which have reasonable probability of simultaneous occurring with due consideration for the methodology of construction particularly in case of soft strata and soils. The design shall be checked for loading conditions during the stages of construction, operation and maintenance.

#### **14.4.3** *Tunnels in rock*

Provisions of Section 4 of IRC:SP:91 shall be followed for the structural design of tunnels passing through rock.

#### **14.4.4** *Tunnels through soft strata and soils*

Structural design of tunnel system passing through soft strata and soils may be carried out by suitable national or international standards, specialist literature and best engineering practices.

### **14.5 Design of Drainage System**

Efficient and effective drainage system shall be provided in the tunnel for the removal of water from rainfall, seepage, tunnel washing operations, vehicle drippings/spillage on fire fighting operations.



**14.5.1** In order to trap rainwater from hill slopes and prevent it from flowing into the approach cuts and the tunnel, suitable catch water drains shall be provided above the top of sides of the open/approach cuts and above excavated portals.

**14.5.2** In the open/approach cuts discontinuous kerbs shall be provided to demarcate the edge of the carriageway. Beyond the kerbs, side drains with adequate waterway shall be provided in the open/approach cuts.

**14.5.3** Inside the tunnel, suitable side drains shall be provided behind the kerbs/crash barriers. Suitable drain pipes going through the kerbs/crash barriers shall be provided to lead seepage and wash water to the drains. The drains shall be located below the walkways meant for the pedestrians and maintenance personnel, as shown in the sketches below. The carriageway shall have suitable camber to facilitate drainage into the side drains. In case of bi-directional tunnel, the camber shall be from the centre outwards and in case of uni-directional tunnel from high speed lane towards low speed lane. The vertical profile shall facilitate self draining of tunnel by providing high point somewhere in the tunnel. However, for long tunnels this may not be possible and detailed draining system shall be designed by providing sumps and combination of self draining and pumping arrangements.

**14.5.4** The black topped road surface inside tunnel, generally constructed on rocky subgrade, gets damaged due to seepage water and creates severe problem for surface drainage. Hence the pavement inside the tunnel and in approach cuts shall be of high performance pavement concrete.

## **14.6 Waterproofing**

Waterproofing in the form of tunnel lining such as cast in situ plains on reinforced concrete shall be provided for structural protection from surrounding weathering effects as well as operational considerations. To prevent water leaks inside the tunnel, water proof sheet at least 0.8 mm thick with synthetic textile buffer between shotcrete and lining shall be provided.

## **14.7 Ventilation**

**14.7.1** Natural ventilation may be sufficient for tunnels of length up to 500 m. However for tunnels of length more than 250 m natural ventilation system should be used only after thorough evaluation of reliance on natural ventilation especially with reference to effects of meteorological and operating conditions.

**14.7.2** Mechanical system of ventilation shall be provided in case of tunnels of length more than 500 m.

**14.7.3** Detailed design of ventilation shall be carried out as per Section 7 of IRC:SP:91 keeping in view the length, shape, size, tunnel environs and complexion of the likely traffic for which tunnel has been designed.

## **14.8 Tunnel Illumination**

Tunnel illumination/lighting shall be designed and provided as per MORTH guidelines for Expressway, Chapter 13.5 for Tunnel Lighting.

## 14.9 Tunnel Furnishing

Provisions shall be made for installation of tunnel furnishing such as sign boards, fire fighting arrangements, cable trays for telephone and power lines etc. in consultation with relevant local authorities.

## 14.10 Signages and Carriageway Markings

**14.10.1** Variable messages signs inside the tunnel shall be provided for the information of traffic of lane blockage/closure due to incidents related to vehicles/non-vehicles, weather and human hazards etc. or maintenance operations as also to warn of possible hazard ahead due to any abnormal situation. Signage system shall be complemented by providing traffic lights above each lane at the entry portal end and inside. Signages indicating distance travelled, distance/direction to an exit on evacuation route shall be provided inside the tunnel.

**14.10.2** Tunnel carriageway markings consisting of a discontinuous line separating the traffic lanes and continuous line separating the lateral traffic lane from the paved shoulder and emergency lay-bye shall have good day/night visibility and conform to IRC:35. The markings shall be done by means of self propelled machine which has a satisfactory cut-off capable of applying broken line automatically.

### 14.10.2.1 Material

- i) Hot applied thermoplastic paint with glass beads shall be used as carriageway marking material.
- ii) Carriageway marking may also be in the form of pre-fabricated sheet material, e.g. plastic sheets, which may be set into the pavement with upper surface flush with the pavement surface.

## 14.11 Emergency Facilities

**14.11.1** Tunnel emergency facilities categorized mitigate damage in the event of incidence of fire or any other accident in the tunnel shall be provided in conformity with the standards for installation of emergency facilities according to the classification based on traffic volume and length of tunnel as shown in **Fig. 14.5** and guidelines of emergency facilities for each classification of tunnel vide **Table 14.1** as per details in following Para 14.11.2.

**14.11.2** Types of details of emergency facilities to be provided are categorized as Information and Alarm Equipment, Fire Extinguishing Equipment, Escape and Guidance Facilities and other equipment. Requirements are as under:

- i) Information and Alarm Equipment
  - a) Emergency Telephone to be used exclusively for dispatching information regarding the occurrence of an accident to the highway authorities by persons involved in or discovering the accident (installed at intervals of 200 m).

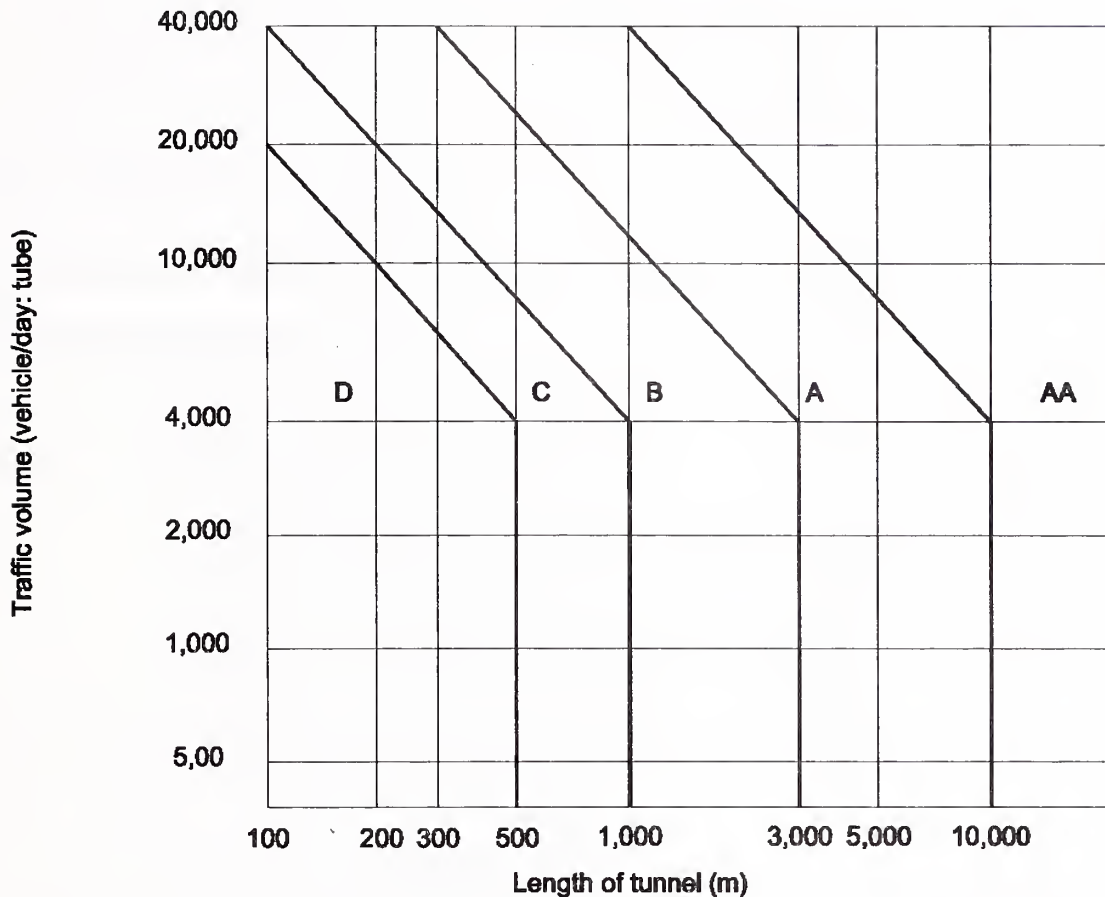

Fig. 14.5 Classification of Tunnels

- b) Push button type information equipment to be pressed by persons involved in or discovering an accident in order to inform the highway authorities etc of the occurrence of the accident (installed at intervals of 50 m).
  - c) Fire Detectors: detect fires and automatically notify their location to the highway authorities etc. (installed at interval of 25 m).
  - d) Emergency Alarm Equipment: when something goes out of order in the tunnel, drivers running in the access zone as well as in tunnel promptly notified through this alarm equipment. The system includes entrance information boards at tunnel entrances and the in-tunnel information boards in emergency parking areas in the tunnels.
- ii) Fire Extinguishing Equipment
- a) **Fire Extinguishers:** Installed for initial control of small-scale fires. Portable powder-type fire extinguisher, two per set, are equipped (installed at intervals of 50 m).
  - b) **Fire Plug:** Hose-reel water plugs are installed for initial control of ordinary fires. Designed even for road users to be able to handle them (installed at intervals of 50 m).

Table 14.01 Installation Standards of Emergency Facilities

Emergency Facilities		Classification	AA	A	B	C	D	Remarks
Information alarm equipment	Emergency telephone		O	O	O	O	O	Omitted in Class D tunnels less than 200 m in Length
	Pushbutton type information equipment		O	O	O	O		
	Fire detector		O	O				Omitted in tunnel without ventilation system
	Emergency alarm equipment	Tunnel entrance information board		O	O	O	O	O
In-tunnel information board			O	*				To be installed in Class A tunnels 3,000 m or more in length
fire extinguishing	Fire extinguisher		O	O	O	O	O	
	Fire plug		O	O	*			To be installed in Class B tunnels 1,000 m or more in length
Escape and guidance equipment	Guide board	Emergency exit lamps	To be installed in tunnels with evacuation aids					
		Guide board	To be installed in tunnels with evacuation aids					
		Emergency exit direction board	To be installed in tunnels with evacuation aids					
		Guide board	O	O	O			To be installed in tunnels without evacuation aids
	Smoke discharge equipment and Escape passage		<ul style="list-style-type: none"> <li>Evacuation aids to be provided in tunnels of around 750 m or more in length.</li> <li>Smoke discharge equipment to be provided in tunnels of around 1,500 m or more in length.</li> <li>Evacuation tunnels provide for those Class AA tunnels and Class A tunnels of a length of 3,000 m or more which employ a two-way traffic system and a longitudinal ventilation system.</li> <li>Either evacuation aids or smoke discharge to be provided for Class AA</li> </ul>					
Other equipment	Hydrant		O	O	*			To be provided in Class B tunnels 1,000 m or more in length. Tunnels equipped with hydrants are to be provided with water supply ports near the entrance.
	Radio communication auxiliary equipment	Coaxial cables	O	*				To be provided in Class A tunnels 3,000 m or more in length.
	Radio rebroadcasting equipment	Entrance/exit telephone	O	O				
		interrupt function provided	O	*				To be provided in Class A tunnels 3,000 m or more in length.
	Cell phone connectivity		O	O	O	O	O	To be provided
	Loudspeaker equipment		To be provided in tunnels equipped with a radio rebroadcasting equipment (with interruption function)					
	Water sprinkler system		O	*				To be provided in Class A tunnels 3,000 m or more in length, and serviced in two way traffic.
	CCTV		O	*				To be provided in Class A tunnels 3,000 m or more in length.
	Lighting equipment for power failure		To be provided in tunnels 200 m or more in length.					
Emergency Power supply equipment	Independent power plant		To be provided in tunnels 500 m or more in length.					
	Non-failure power supply equipment		To be provided in tunnels 200 m or more in length.					

LEGEND:

O- Mandatory

\* - Use with consideration

- c) **Smoke Discharge Equipment:** When a fire arises, this device keeps the spread of smoke to a minimum level and also functions to force smoke to be discharged. Usually, ventilation equipment (working in reverse mode) is used as a smoke remover.
- iii) **Escape and Guidance Facilities**
- a) **Guide board:** in an emergency, these direct road users in the tunnel the distance/direction to an exit or evacuation route, the current position, and other information.
- b) **Escape Passage:** These are evacuation tunnels and evacuation exits for the road users in the tunnel to a safe place. The former is built for escape, separately from the main tunnel, while the latter connects the main tunnel to an evacuation which runs in parallel with it, or two main tunnels. The evacuation tunnel may have a vertical clearance of 4.5 m. The exit for evacuation shall be shutter type of light weight and non-flammable materials. Adequate signage for direction of movement and easy opening mechanism shall be provided. Evacuation tunnel shall be used only by the evacuating persons and emergency vehicles.
- iv) **Other Equipment**
- a) Hydrant supply water for fire fighting activities by fire service crew. The storage capacity of tank is designed to supply water to the following fire Fighting measures for at least 40 minutes simultaneously. Design allowance shall be 20 percent extra.
- three fire hydrants (with fire hose)
  - two sections of sprinkler
  - two hydrants.
- b) **Radio Communication Auxiliary Equipment:** Used for communication with the fire squads engaged in rescue or fire-Fighting activities in the tunnel.
- c) **Mobile Connectivity:** Arrangements for mobile connectivity shall be provided.
- d) **Radio Rebroadcasting Equipment:** This is installed in the tunnel so that radio broadcasting can be made by the authorities to transmit information in an emergency.
- e) **Loudspeaker Equipment:** Reliable information is supplied to those who have alighted from their vehicles.
- f) **Water Sprinkler System:** Sprinkle fire particles of water from water spray heads in order to prevent fire from spreading, support fire-Fighting activities.

- g) **Observation Equipment:** CCTV with zoom function are installed at intervals of 200 m.
- h) **Lighting Equipment for Power Failure:** Maintains minimum lighting required during power failure or a fire.
- i) **Emergency Power Supply Equipment:** Used to keep emergency facilities functioning during power failure. There are two kinds, storage cell type and an independent power plant.

## **14.12 Safety During Construction**

**14.12.1** It shall be ensured that all applicable rules and regulations relating to the construction of tunnels are duly complied with in strict conformity with the spirit and body of such regulations.

**14.12.2** A Project Safety Plan (PSP) relevant to particular site shall be prepared by the Concessionaire and got approved from the competent authority. The PSP shall address all site-specific issues and take all the identified risk elements. During all operations connected with the construction of tunnels appropriate safety precautions shall be taken through the implementation of the PSP.

**14.12.3** An emergency management plan shall be part of the approved Project Safety Plan which shall be well communicated to all working personnel and prominently displayed at site. Emergency Research Measures should be drawn up to take care of various possible contingencies.

**14.12.4** Provisions of Section 6 of IRC: SP: 91 shall generally be followed for safety during construction of tunnels.



**Appendix-1**  
(Refer Clause 10.4.10)

(To be published in the Gazette of India, Part 1, Section 1)  
No.H-25011/04/2011-P&P (Toll) Vol.II  
MINISTRY OF ROAD TRANSPORT & HIGHWAYS  
New Delhi-110001 the August, 2011

**RESOLUTION**

The Government of India in response to public demand has constituted a Committee on 20<sup>th</sup> April, 2010 under the chairmanship of Nandan Nilekani, Chairman, Unique Identification Authority of India to recommend the adoption of Electronic Toll Collection (ETC) System across India's National Highways Network. The Committee has submitted its report on 28.6.2010 and to implement the recommendations of the Committee, Government has constituted an Apex Committee to finalise the required standards for the different components of ETC system and then suggest the operational methodology for implementation and operation of ETC. Apex Committee has finalised the specifications for the following :-

- i) RFID Transceiver
- ii) RFID Tag
- iii) Data exchange format between Toll Plaza Server and the Central ETC System.

These specifications are meant for Unified Electronic Toll Collection System across the country for all toll plazas on the National Highways. The detailed specifications are given below:-

**1. Specifications for RFID Transceiver**

**1.1 General**

S. No.	Parameter	Particular
1)	Frequency	UHF 865 MHZ to 867 MHZ*
2)	Communication	Ethernet/ Serial communication (EIA standard RS 232 C/ RS 485)
3)	RF Power maximum	1 W-transmitted & 4 W-EIRP (Equivalent maximum Isotropically Radiated Power) *
4)	Reading distance	With the Transceiver mounted typically at a height of 6 m above the road surface, the coverage of the antenna shall not exceed a diameter of 3.6 m.
5)	Antenna	Circularly Polarized

6)	Protocol	EPC Gen 2, ISO 18000-6C and shall comply with the general conformance requirements of the standard
7)	Visual diagnostics	The Transceiver shall have LED indicators for sense; transmit Fault and Power which shall be visible clearly to the operator on ground while the system is operation.

\* is in the wireless license free band for RFID use in India. Typical existing product(s) for 'RFID-based-ETC' operates in the 865 MHz- 868 MHz band.

## 1.2 Environmental

S. No.	Parameter	Particular
1)	Enclosure	Light weight enclosure for the RFID Transceiver and circularly polarized antenna
2)	Environmental	IP 65 or better for outdoor units
3)	Relative Humidity	95% Condensing
4)	Operating Temperature	-20°C to 55°C
5)	Storage Temperature	-40°C to 85°C

## 1.3 Operating Characteristics

S. No.	Parameter	Particular
1)	Air Interface & Adaptive Noise Features	The Transceiver technology employed should have the capability to optimize read rates for the vehicle identification application and adapt to instantaneous noise and interference level
2)	Application capability	1) Should have read reliability exceeding 99.5% in the distance range specified. 2) Diagnostic and Reporting Tools
3)	Upgradeability	The firmware should be upgradable to support future protocols.
4)	Transaction Capability	Reading of Tag & EPC memory for at least 2 Tags per second for a moving vehicle with a speed limit of 40 kilometres/ hour.
5)	Driver Software	The transceiver driver software shall be provided along with the transceiver that will interface to the ETC client through socket interface and handle the communication with ETC client. The packet structures shall be as notified in the ETC client-transceiver interface. The driver software shall implement filtering using a range of EPC-codes provided by set of bit pattern masks.



## 2. Specifications for RFID Tag

The Tags shall be essentially non-transferable RFID transponders designed to be used in conjunction with compatible Transceivers and are meant to identify the vehicle for ETC application.

### 2.1 General

S. No.	Parameter	Particular
1)	Power	Tags are Passive
2)	Frequency	UHG 860 MHZ to 960 MHZ as per EPC Gen 2 standards
3)	Data Transfer Rate	At least 512 kbps under ideals conditions & 64 to 512 kbps under field conditions
4)	Protocol	EPC Gen 2, ISO 18000-6C
5)	Dimensions (including the substrate/backing)	Maximum area occupied on the windshield shall be 50 Sq. Cm.
6)	Material	Plastic substrate with printed antenna.
7)	Physical printing of Tag ID on the Tag	The Tag ID shall be physically printed on the Tag using the Hexadecimal numbering system and shall be adequately clear for easy visual recognition.
8)	Tamper Proof RFID Label	<p>The tags should be RFID Tamper Proof Label specially designed for tagging directly to a surface, such as Glass (windshield) of an automobile. Any attempt to rip or tamper the label (tag) should result in disabling the functionality of tags to ensure a unique one to one relationship between the tag and the vehicle thereby parenting unauthorized tag removal and transfers. Such features of the RFID label should result in following actions:</p> <ol style="list-style-type: none"> <li>1) Destroy or Damage the Antenna</li> <li>2) Break the chip-antenna connection</li> </ol> <p>The manufacturing process, construction of tags and associated materials should ensure reliable tamper indication even when sophisticated tamper methods of Mechanical Attack (e.g. Razor Blades, Knives etc). Chemical Attack (using Corrosives Solvents etc.) and Thermal Attacks are employed.</p>

## 2.2 Environmental

S. No.	Parameter	Particular
1)	Relative Humidity	95% Condensing
2)	Operating Temperature	-20°C to 80°C ambient
3)	Storage Temperature	-40°C to 100°C

## 2.3 Installation

S. No.	Parameter	Particular
1)	Location	The RFID Tag shall be installed at a fixed location on the inside of the Windshield of the vehicle. *
2)	Installation mechanism	<p>The RFID Tag shall have a self-adhesive backing with which it can be fixed to inside of the windshield. The adhesive shall be such that</p> <ul style="list-style-type: none"> <li>• It allows reliable and accurate reading of the Tag by the Transceiver located at a specified distance.</li> <li>• The RFID chip and/or the antenna get irreparably damaged when an attempt is made to remove the installed Tag from the windshield by any means. Detailed functionality is given in point No. 8 of Para 3.2.1 of this document.</li> <li>• The tamper proof attribute will be test from accredited testing organization before taking delivery</li> </ul>

\* location to be optimized for each class of vehicle during trials

## 2.4 Memory

S. No.	Parameter	Particular
1)	Tag Memory (minimum)	Unique Tag ID-64 bits. EPC memory - 240 bits
2)	Data Retention	10 Years minimum with UV protection for normal sunlight exposure and ambient temperature of 45°C

## 3 AVI Processes

To ensure standardization as well as security in the system, vehicle identification as well as Tag commissioning & initiation processes are also defined below.

### **3.1 Tag commissioning**

**3.1.1** Each Tag will be required to have a non-changeable and unique Tag ID, which must be read by the Transceiver at the point-of-sale.

**3.1.2** At the time of commissioning, the point-of-sale module shall read the unique Tag ID and allocate an EPC code & a randomly generated initiation code. It shall then write the EPC code, Vehicle registration number, vehicle class code and the initiation code in the EPC memory area using the software module provided. The Tag ID, EPC code, Vehicle registration number, the vehicle class code and initiation code shall also be stored in the central database.

### **3.2 Tag initiation**

**3.2.1** Tag initiation will be a process carried out during Tag commissioning or when the originalowner suspects a cloning of the Tag.

**3.2.2** In the first case, the Tag initiation software shall generate a random initiation code, write in the Tag and store in the central database as mentioned in Para 4.1.2. Each time a Tag is read by the Transceiver for tag commissioning, a new initiation code will be generated, written on the Tag and stored in the central database along with other information.

**3.2.3** In the second case, the Tag initiation software shall generate a random initiation code and read Tag ID, EPC code, vehicle registration number & vehicle class code from the Tag mounted on the windshield. After due verification from the central database, the value of initiation code shall be updated on the Tag as well as on the central database. Old initiation code and EPC code shall be marked for special handling for 'catching' the clone as and when the cloned Tag comes into contact with Transceivers at the toll gates.

## **4. Automatic Vehicle Identification at Toll Point**

**4.1** The communication sequence between the Transceiver and Tag shall conform to ISO 18000-6C.

**4.2** The Transceiver shall retrieve the Tag and EPC memory contents for those Tags whose EPC code satisfies the mask stored in the Transceiver for a matching entry. The EPC code shall be used to index into the database from where the Tag ID, Vehicle registration number, the Vehicle class code and the initiation code will be retrieved from the database and verified against the corresponding values read from the Tag.

5. Data Format

5.1 Schematic

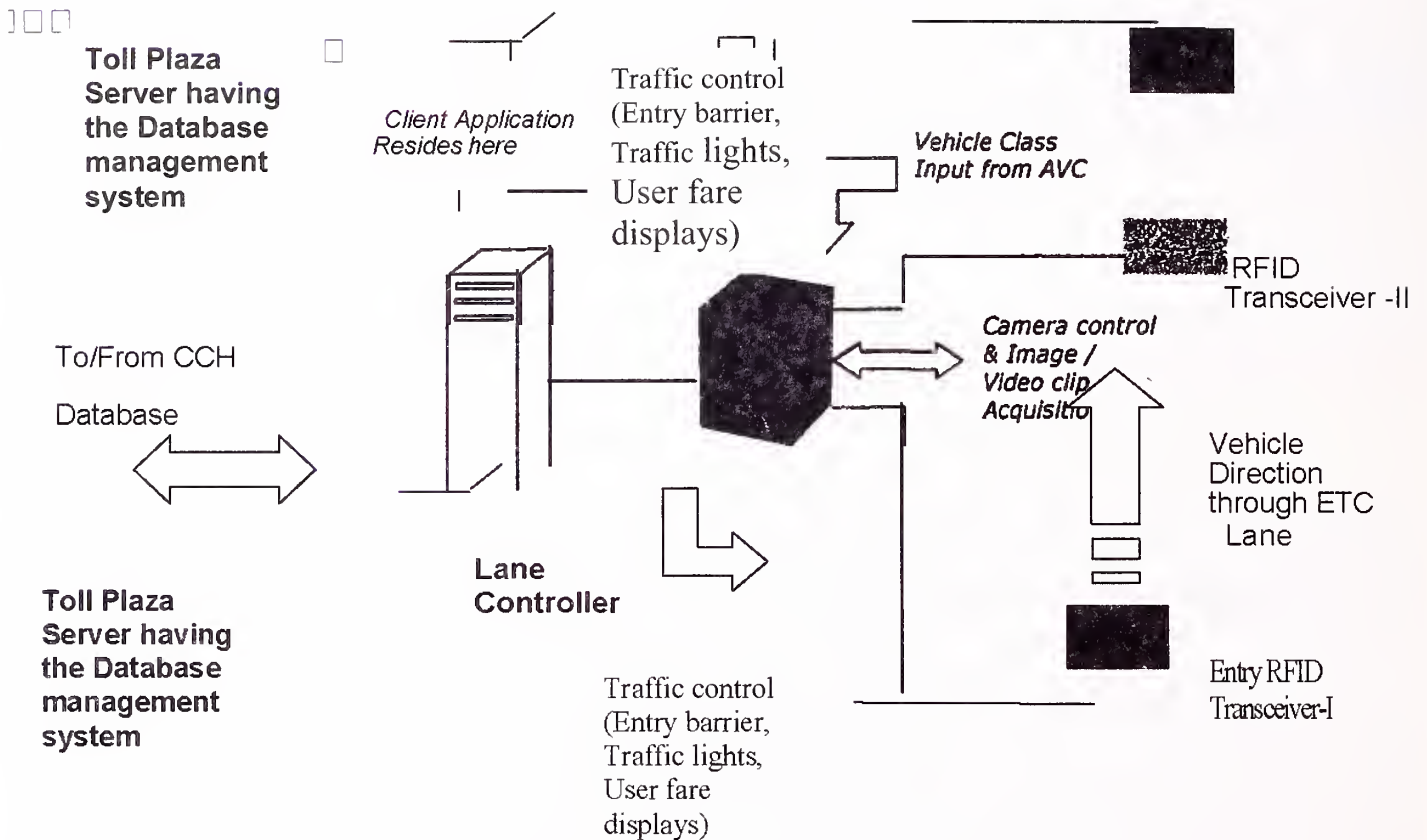

5.2 Data downloaded from Central Database into Data Management System (Toll Plaza Server) and each lane controller

S. No.	Data	Size and format	No. of Values of Data Parametre to be Stored in the Data Management System (Max.)	Remarks
1)	Tag ID (The Tag ID on the Tag is only 8 bytes long but extra memory has been provided in the database)	20 Bytes per vehicle	5,000,000	Written into the Database during Tag commissioning
2)	EPC Code	12 Bytes per vehicle	5,000,000	Written into the Database during Tag commissioning
3)	Vehicle Registration number	12 Bytes per vehicle	5,000,000	Written into the Database during Tag commissioning

S. No.	Data	Size and format	No. of Values of Data Parametre to be Stored in the Data Management System (Max.)	Remarks
4)	Vehicle Class code	2 Bytes per vehicle	5,000,000	Written into the Database during Tag commissioning
5)	Initiation code	4 Bytes per vehicle	5,000,000	3 Bytes random no. & 1 Byte checksum on Item nos. 2 to 5
6)	Tag Status (Valid, Exempt, Blacklisted)	1 Byte per vehicle	5,000,000	-

The above data is downloaded from the central Data base at User-settable time intervals varying between 15 min to 8 hours.

### 5.3 Toll Tariff tables downloaded from Central Database into Data Management System (Toll Plaza Server) and each lane controller

**5.3.1** This table contains the approved toll tariff records for the toll plaza. The toll tariff can be based on vehicle class, lane type, time of day and shall be applicable from a given start date only. The table will contain all the toll tariff records- the old, current and future. Any discounting for local road users must be done by the clearing house. The table is likely to be updated each time the toll tariff is revised (typically about once in 2 years).

S. No.	Data	Size and format	No. of Values of Data Parameter to be Stored in the Data Management System	Remarks
1)	Vehicle Class Code	20 Bytes	As many required	-
2)	Lane Type	20 Bytes	As many required	Valid Values will be 'Cash Lane', 'ETC Lane', 'Premium cash lane.
3)	Valid from Data	20 Bytes	As many required	Date of start of applicability of toll fare.
4)	Time Interval from	20 Bytes	As many required	Can be used for time differential toll charges
5)	Time interval till	10 Bytes	As many required	Can be used for time differential toll charges

## 5.4 Transaction data generated by client application for ETC vehicle

**5.4.1** Transactions generated (described under section 2.2.g.III in this document) by the client application is transferred to the Central Clearing House database. Each Transaction consists of the following items. Data Size are larger than what is required now and are designed to handle future expansion

S. No.	Data	Data Size	Remarks
1)	Date and Time Stamp	20 Bytes	Time stamp of the vehicle passing through the toll plaza
2)	Transaction identification	16 Bytes	This field uniquely identifies transaction. and comprises of Transaction Serial number (8 bytes), Controller ID (2 bytes), Toll Plaza (1 bytes) and Toll Operator ID (3 bytes).
3)	Tag ID	20 Bytes	As read from the vehicle against the database
4)	EPC Code	12 Bytes	As read from the vehicle against the database
5)	Vehicle Registration number	12 Bytes	As read from the vehicle against the database
6)	Vehicle Class code	2 Bytes	As read from the vehicle against the database
7)	Initiation code	4 Bytes	As read from the vehicle against the database
8)	Tag Status (Valid, Exempt, Blacklisted)	1 Byte	As read from the toll plaza replica of the CCH database
9)	Toll Amount	10 Bytes	Non-Discounted. Any discount on this shall be implemented by the Clearing house
10)	Vehicle Image	100 kb	JPEG format

**5.4.2** Transactions shall be uploaded into the central Database at User settable time intervals varying between 5 minutes to 8 Hours (Vehicle image need not be uploaded to the Central database to minimize the network bandwidth).

**5.4.3** The Data management system (Toll Plaza server) shall have the capacity to store at least 280,000 such transactions per lane.

## 5.5 Data in Central Database for ETC vehicle

5.5.1 Replica of this data (Item 1 to 6) shall be available at the toll plaza. The replica shall be made for only valid Tags including those that are listed for special handling.

S. No.	Data	Size and format
1)	Tag ID (The Tag ID on the Tag is only 8 bytes long but extra memory has been provided in the database)	20 Bytes
2)	EPC Code	12 Bytes
3)	Vehicle Registration number	12 Bytes
4)	Vehicle Class code	2 Bytes
5)	Tag Status (Valid, Exempt, Blacklisted)	1 Byte
6)	Initiation code	4 Bytes
7)	Tag Registration Date	20 Bytes
8)	Vehicle Owner details consisting of name, address, phone numbers, bank account details, credit card details, balance details (when paid, amount paid and current balance), valid-up-to details (when the information is going to be not considered)	a) Name - 90 Bytes and (including first, middle and Surname) b) Contact details: Address- Free format c) Phone numbers (Landline Mobile telephone numbers) bytes each E-mail address - Free format d) Bank Account details: Branch Name - 12 Bytes IFSC Code- 12 Bytes e) Credit Card Details: Credit card No -16 Bytes Type of Card (Jisa/Master Card/...) - 11 Bytes Issuing Bank - 10 Bytes 'Valid up to' Date- 20 Bytes f) Balance Details: Date paid -20 Bytes, Amount paid -10 Bytes Current balance -10 bytes g) 'Valid up to' Date - 20 Bytes

(Sanjay Bandopadhaya)  
Joint Secretary to the Govt. of India

ORDER

ORDERED that a copy of the resolution be placed on the Ministry's website for wide publication.

ORDERED also that the resolution be published in the Gazette of India for general information.

**(Sanjay Bandopadhaya)**  
Joint Secretary to the Govt. of India

To

The Manager

Government of India Press

(Bharat Sarkar Press)

FARIDABAD.



**Appendix-2**  
*(Refer Clause 10.4.10)*

**ETC PRE-SCREENING ARRANGEMENT AND OPERATION**

A) **VEHICLE WITH VALID TAG:** when the vehicle approaches the dedicated ETC lane, the first transceiver reads the Tag and allow the vehicle to proceed.

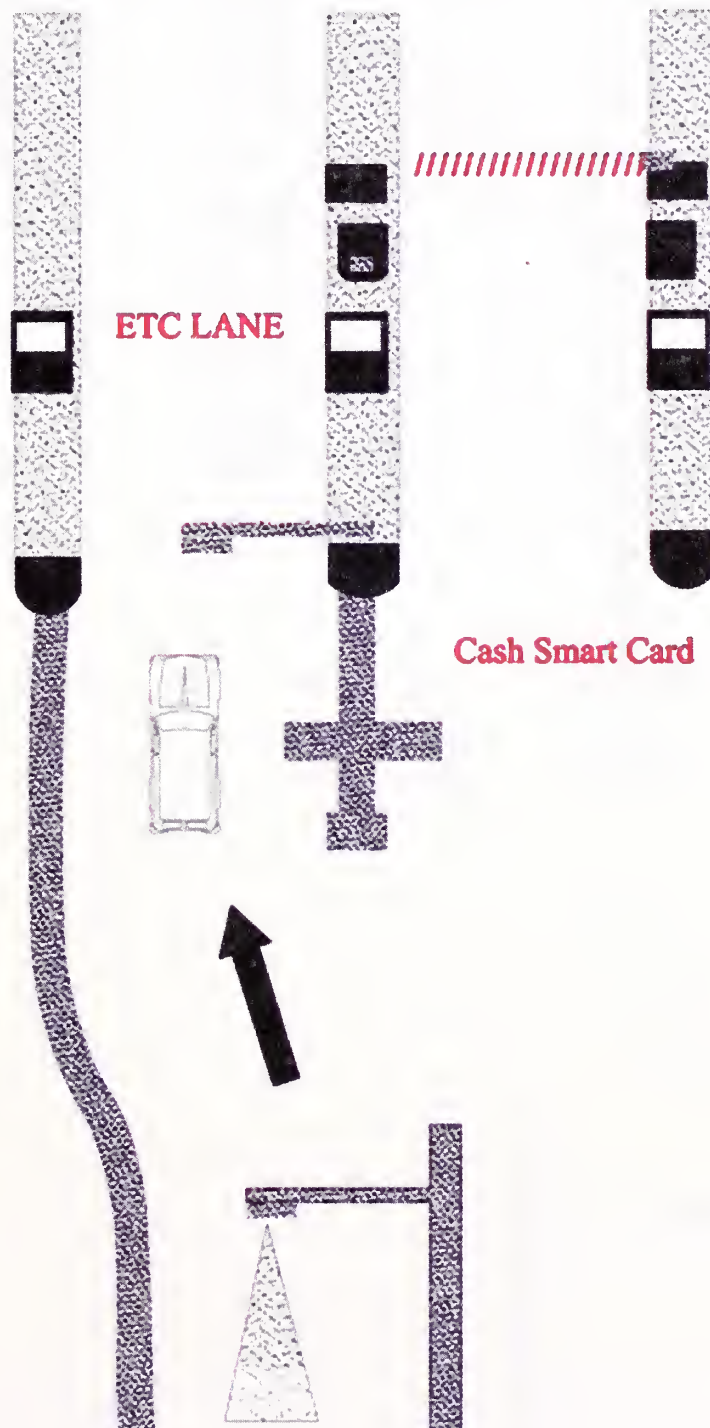

B) **VEHICLE WITHOUT TAG OR INVALID TAG:** when the vehicle approaches the dedicated ETC Lane, the first transceiver detects vehicle as non-Tag | invalid Tag and bring down the barrier blocking the entry to ETC lane. This will force the vehicle to eject from the ETC Lane and go to adjacent cash Lanes.

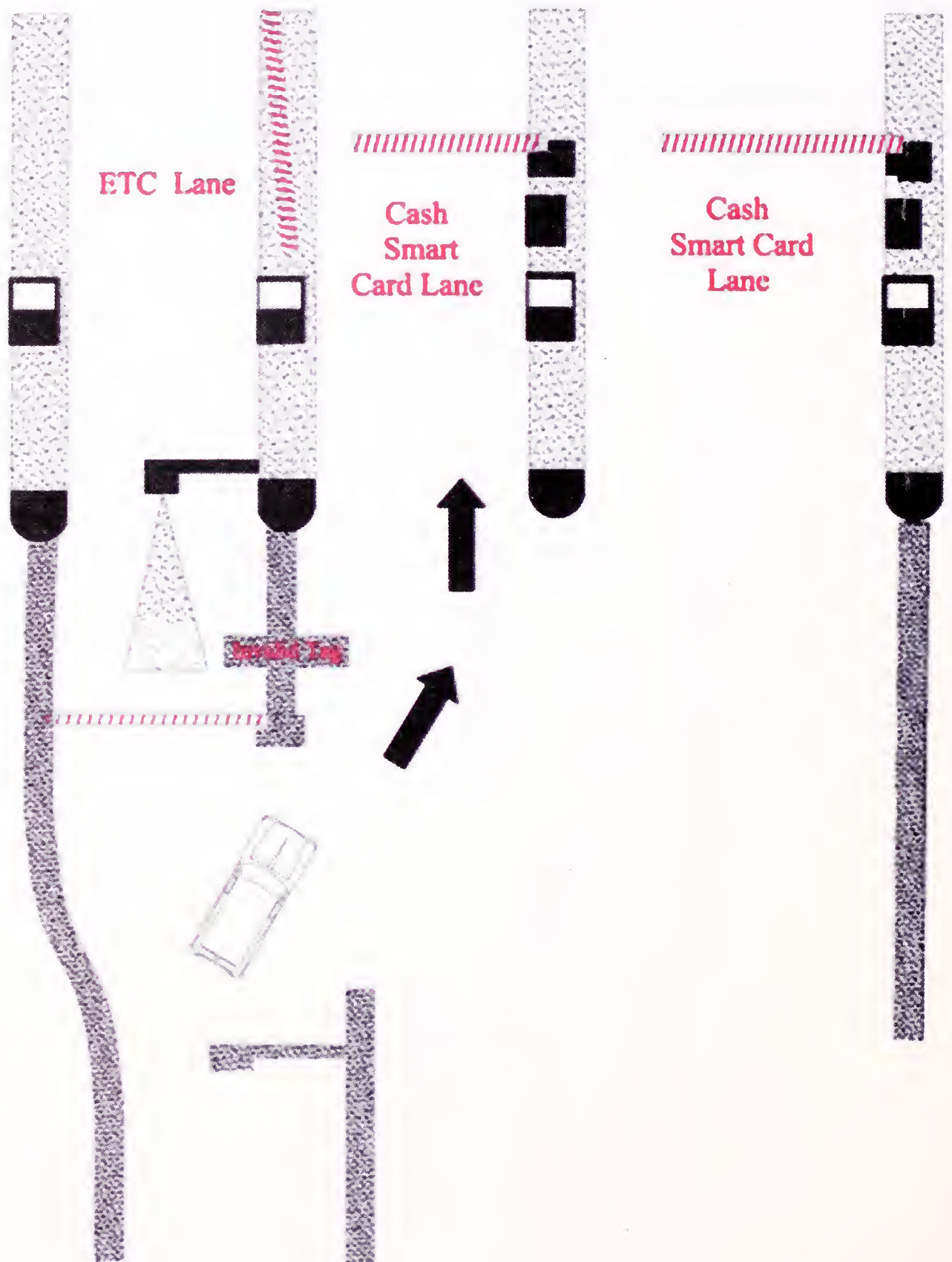





**(The Official amendments to this document would be published by the IRC in its periodical, 'Indian Highways' which shall be considered as effective and as part of the code/guidelines/manual, etc. from the date specified therein)**