

**Handbook
on
Causes
and
Prevention
of
Cracks
in
Buildings**

BUREAU OF INDIAN STANDARDS

**Handbook
on
Causes
and
Prevention
of
Cracks
in
Buildings**

BUREAU OF INDIAN STANDARDS
MANAK BHAVAN, 9 BAHADUR SHAH ZAFAR MARG, NEW DELHI-110002

SP : 25-1984

© BUREAU OF INDIAN STANDARDS, 1985

Second Reprint SEPTEMBER 1990

Third Reprint JULY 1994

Fourth Reprint MARCH 1999

UDC 69.059.22 (021)

ISBN 81-7061-015-X

PRICE Rs. 200.00

PRINTED IN INDIA AT KAY KAY PRINTERS, 150-D KAMLA NAGAR, DELHI 110007 AND
PUBLISHED BY BUREAU OF INDIAN STANDARDS, 9 BAHADUR SHAH ZAFAR MARG, NEW DELHI 110002

**CAUSES AND PREVENTION
OF CRACKS IN BUILDINGS**

As in the Original Standard, this Page is Intentionally Left Blank

FOREWORD

Users of various civil engineering codes have been feeling the need for explanatory handbooks and other compilations based on Indian Standards. The need has been further emphasized in view of the publication of the National Building Code of India in 1970 and its implementation. The Expert Group set up in 1972 by the Department of Science and Technology, Government of India, carried out in-depth studies in various areas of civil engineering and construction practices. During the preparation of the Fifth Five-Year Plan in 1975, the Group was assigned the task of producing a Science and Technology plan for research, development and extension work in the sector of housing and construction technology. One of the items of this plan was the production of design handbooks, explanatory handbooks and design aids based on the National Building Code and various Indian Standards, and other activities in the promotion of the National Building Code. The Expert Group gave high priority to this item and on the recommendation of the Department of Science and Technology, the Planning Commission approved the following two projects which were assigned to the Indian Standards Institution:

- a) Development programme on code implementation for building and civil engineering construction, and
- b) Typification for industrial buildings.

A Special Committee for Implementation of Science and Technology Projects (SCIP) consisting of experts connected with different aspects was set up in 1974 to advise the ISI Directorate General in identifying the handbooks and for guiding the development of the work. Under the first project, the Committee has so far identified subjects for several explanatory handbooks/compilations covering appropriate Indian Standards/Codes/Specifications which include the following:

- Design Aids for Reinforced Concrete to IS:456-1978 (SP:16-1980)
- Explanatory Handbook on Masonry Code (SP:20-1981)
- Explanatory Handbook on Codes of Earthquake Engineering (IS:1893-1975 and IS:4326-1976) (SP:22-1982)
- Handbook on Concrete Mixes (SP:23-1982)
- Explanatory Handbook on Indian Standard Code of Practice for Plain and Reinforced Concrete (IS:456-1978) (SP:24-1983)
- Handbook on Causes and Prevention of Cracks in Building
- Summaries of Indian Standards for Building Materials
- Concrete Reinforcement and Detailing
- Functional Requirements of Buildings
- Functional Requirements of Industrial Buildings
- Timber Engineering
- Foundation of Buildings
- Steel Code (IS:800)
- Building Construction Practices
- Bulk Storage Structures in Steel
- Formwork
- Fire Safety
- Construction Safety Practices
- Tall Buildings
- Inspection of Different Items of Building Work
- Loading Code
- Prefabrication

The Handbook on Causes and Prevention of Cracks in Buildings, which is one of the handbooks in this series, deals with the various causes of non-structural cracks which are due to moisture changes, thermal variations, elastic deformation, creep, chemical reaction, foundation movement and settlement of soil, vegetation, etc; it gives some typical examples of occurrence of cracks together with measures for prevention of cracks. This also covers guidelines for diagnosing causes of cracks of various types and suggestions for suitable remedial measures, where feasible.

The Handbook, it is hoped, would provide useful guidance to architects, engineers and construction agencies connected with planning, designing, construction and maintenance of buildings for avoiding/minimizing cracks.

The Handbook is based on the draft prepared by Shri M. S. Bhatia, Retired Engineer-in-Chief, Central Public Works Department (Government of India). The draft Handbook was circulated for review to Central Designs Organization, Central Public Works Department, New Delhi; Engineer-in-Chief's Branch, Army Headquarters, New Delhi; Central Building Research Institute, Roorkee; Public Works Department, Government of Andhra Pradesh; Public Works Department, Government of Tamil Nadu; Public Works Department, Government of Uttar Pradesh; Directorate General, Posts and Telegraph, New Delhi; M/s C. R. Narayana Rao, Madras; Indian Institute of Technology, Kanpur, Delhi Development Authority, New Delhi and India Meteorological Department, New Delhi and their views have been taken into consideration, while finalizing the Handbook. Indian Standards Institution also acknowledges useful comments and suggestions given to Shri Bhatia on the draft Handbook by Shri C. P. Malik, Retired Engineer-in-Chief, Central Public Works Department; Shri V. R. Vaish, Retired Director General, Central Public Works Department; Shri O. P. Mittal, Retired Chief Engineer, Central Public Works Department; Shri A. P. Paracer, Chief Engineer, Posts and Telegraphs, New Delhi; Shri A. Sankaran, Chief Engineer, Central Public Works Department, New Delhi; Shri H. R. Laroya, Chief Architect, Central Public Works Department, New Delhi and Shri C. S. P. Shastri, Executive Engineer, Central Public Works Department, New Delhi

Composition of the Special Committee for Implementation of Science and Technology Projects (SCIP)

CHAIRMAN

MAJ-GEN HARKIRAT SINGH*
W-51 Greater Kailash I, New Delhi 110048

MEMBERS

SHRI A. K. BANERJEE

PROF DINESH MOHAN

SHRI V. RAO AIYAGARI

DR M. RAMAIAH

SHRI G. S. RAO

SHRI A. CHAKRABORTY (*Alternate*)

SHRI T. K. SARAN

DR H. C. VISVESVARAYA

SHRI G. RAMAN

(*Member Secretary*)

REPRESENTING

Metallurgical and Engineering Consultants (India)
Limited, Ranchi

Central Building Research Institute, Roorkee

Department of Science and Technology, New Delhi

Structural Engineering Research Centre, Madras

Central Public Works Department, New Delhi

Bureau of Public Enterprises, New Delhi

Cement Research Institute of India, New Delhi

Indian Standards Institution, New Delhi

CONTENTS

SECTION 1 INTRODUCTION	...	2
SECTION 2 MOISTURE MOVEMENT	...	4
SECTION 3 THERMAL MOVEMENT	...	11
SECTION 4 ELASTIC DEFORMATION	...	25
SECTION 5 MOVEMENT DUE TO CREEP	...	32
SECTION 6 MOVEMENT DUE TO CHEMICAL REACTION	...	38
SECTION 7 FOUNDATION MOVEMENT AND SETTLEMENT OF SOIL	...	43
SECTION 8 CRACKING DUE TO VEGETATION	...	45
SECTION 9 DIAGNOSIS AND REPAIR OF CRACKS	...	46
SECTION 10 SUMMARY OF MEASURES FOR PREVENTION OF CRACKS IN STRUCTURES	...	61
APPENDIX A MONITORING AND MEASURING MOVEMENT OF CRACKS	...	66
BIBLIOGRAPHY	...	67
TABLES		
1. MOISTURE MOVEMENT OF SOME COMMON BUILDING MATERIALS	...	4
2. GENERAL PRECAUTIONS FOR AVOIDANCE OF SHRINKAGE CRACKS IN THE USE OF SOME COMMON BUILDING MATERIALS	...	10
3. COEFFICIENT OF THERMAL EXPANSION OF SOME COMMON BUILDING MATERIALS (WITHIN THE RANGE 0°C to 100°C)	...	12
4. HEAT REFLECTIVITY COEFFICIENT OF SOME COMMON BUILDING MATERIALS	...	12

SECTION 1 INTRODUCTION

1.1 Cracks in buildings are of common occurrence. A building component develops cracks whenever stress in the component exceeds its strength. Stress in a building component could be caused by externally applied forces, such as dead, live, wind or seismic loads, or foundation settlement or it could be induced internally due to thermal movements, moisture changes, chemical action, etc.

1.2 Cracks could be broadly classified as structural or non-structural. Structural cracks are those which are due to incorrect design, faulty construction or overloading and these may endanger the safety of a building. Extensive cracking of an RCC beam is an instance of structural cracking. Non-structural cracks are mostly due to internally induced stresses in building materials and these generally do not directly result in structural weakening. In course of time, however, sometime non-structural cracks may, because of penetration of moisture through cracks or weathering action, result in corrosion of reinforcement and thus may render the structure unsafe. Vertical cracks in a long compound wall due to shrinkage or thermal movement is an instance of non-structural cracking. Non-structural cracks, normally do not endanger the safety of a building, but may look unsightly, or may create an impression of faulty work or may give a feeling of instability. In some situations, cracks may, because of penetration of moisture through them, spoil the internal finish, thus adding to cost of maintenance. It is, therefore, necessary to adopt measures for prevention or minimization of these cracks. This Handbook deals with causes and prevention of non-structural cracks, that is, such cracks as are not due to structural inadequacy, faulty construction, overloading, etc.

1.3 Internally induced stresses in building components lead to dimensional changes and whenever there is a restraint to movement as is generally the case, cracking occurs. Due to dimensional changes caused by moisture or heat, building components tend to move away from stiff portions of the building which act as fixed points. In case of symmetrical structures, the centre of the structure acts as a fixed point and movement takes place away from the centre. A building as a whole can easily move in the vertical direction, but in the horizontal direction, sub-structure and foundation exert a restraining action on the movement of the superstructure. Thus, vertical cracks occur in walls more frequently due to horizontal movement. Volume changes due to chemical action within a component

result in either expansion or contraction and as a result cracks occur in the components.

1.4 Internal stresses in building components could be compressive, tensile or shear. Most of the building materials that are subject to cracking, namely, masonry, concrete, mortar, etc, are weak in tension and shear and thus forces of even small magnitude, when they cause tension or shear in a number, are able to cause cracking. It is possible to distinguish between tensile and shear cracks by closely examining their physical characteristics. In Fig. 1 to 4 some typical cracks have been shown to bring out the difference between tensile and shear cracks.

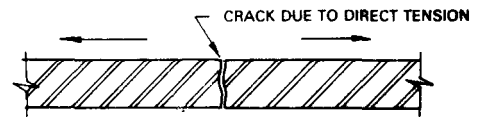

Fig. 1 Tensile Crack in a Masonry Wall

1.5 Cracks may appreciably vary in width from very thin hair cracks barely visible to naked eye (about 0.01 mm in width) to gaping cracks 5 mm or more in width. A commonly known classification¹ of cracks, based on their width is: (a) *thin*—less than 1 mm in width, (b) *medium*—1 to 2 mm in width, and (c) *wide*—more than 2 mm in width. Cracks may be of uniform width throughout or may be narrow at one end, gradually widening at the other. Cracks may be straight, toothed, stepped, map pattern or random and may be vertical, horizontal or diagonal. Cracks may be only at the surface or may extend to more than one layer of materials. Occurrence of closely spaced fine cracks at surface of a material is sometimes called 'crazing'. Cracks from different causes have varying characteristics and it is by careful observation of these characteristics that one can correctly diagnose the cause or causes of cracking and adopt appropriate remedial measures.

1.6 Depending on certain properties of building materials, shrinkage cracks may be wider but further apart, or may be thin but more closely spaced. As a general rule, thin cracks, even though closely spaced and greater in number, are less damaging to the structure and are not so objectionable from aesthetic and other considerations as a fewer number of wide cracks.

1.7 Modern structures are comparatively tall and slender, have thin walls, are designed for higher stresses and are built at a fast pace. These structures are, therefore, more crack-prone as compared with old structures which used to be low, had thick walls, were lightly stressed and were built at a slow pace.

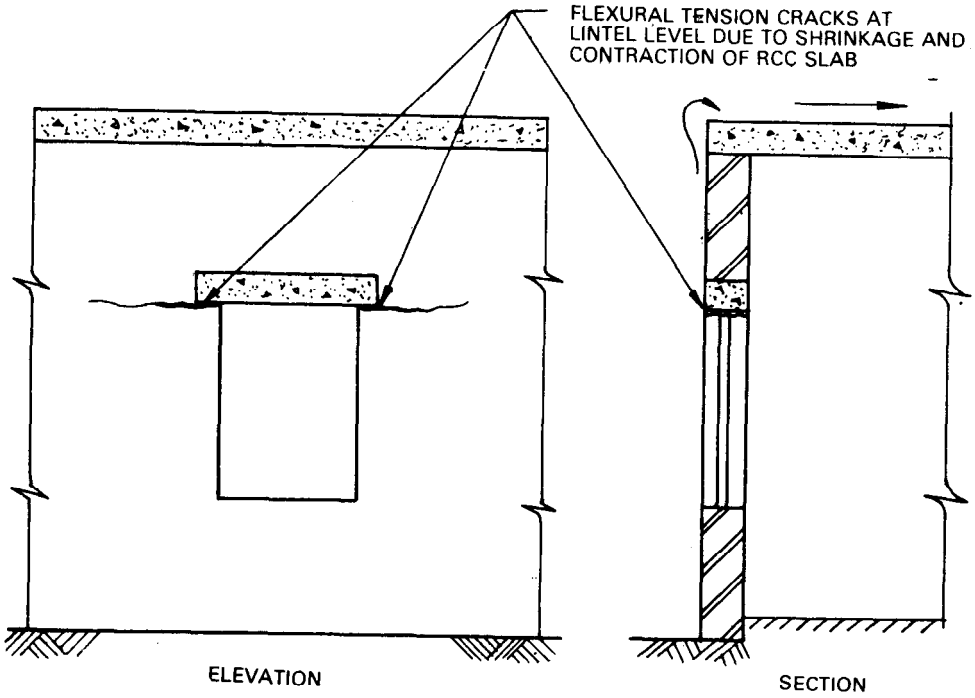

Fig. 2 Flexural Tension Crack in Wall Masonry

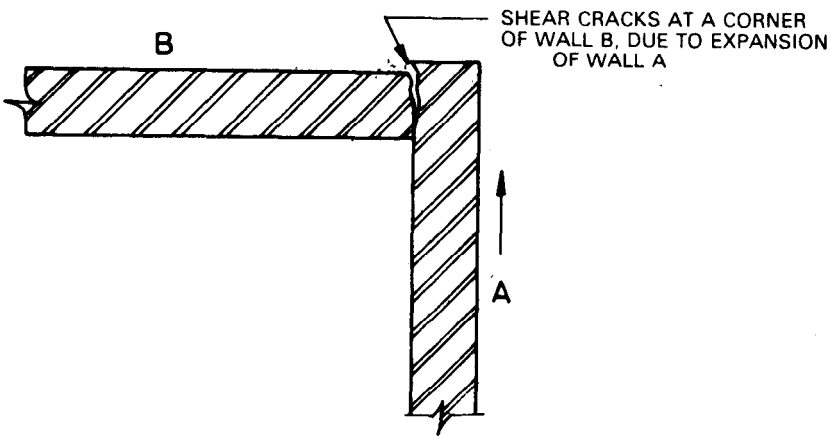

Fig. 3 Shear Crack in Masonry Wall

Moreover, moisture from rain can easily reach the inside and spoil the finish of a modern building which has thin walls. Thus measures for control of cracks in buildings have assumed much greater importance on account of the present trends in construction.

1.8 Principal causes of occurrence of cracks in buildings are as follows:

- a) moisture changes,
- b) thermal variations,
- c) elastic deformation,

- d) creep,
- e) chemical reaction,
- f) foundation movement and settlement of soil, and
- g) vegetation.

In order to be able to prevent or to minimize occurrence of cracks, it is necessary to understand basic causes of cracking and to have knowledge about certain properties of building materials. In this Handbook, various causes, of cracking have been discussed in

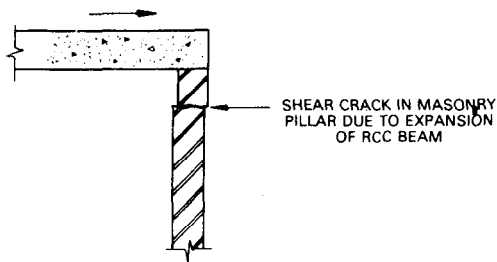

Fig. 4 Shear Crack in Masonry Pillar at Beam Support

detail and some typical examples of occurrence of cracks together with recommendations for measures for prevention of cracks have been given. Some guidance has also been given for diagnosing causes of cracks that may have occurred in a structure and suitable remedial measures, where feasible, have been suggested. For facility of ease of reference and ready information, a summary has been given of various measures to be taken for prevention of cracks in structures in the last chapter of the Handbook.

1.9 A list of books, journals, standards and other publications from which help has been derived in the preparation of this Handbook has been given at the end.

SECTION 2 MOISTURE MOVEMENT

2.1 General

2.1.1 As a general rule, most of the building materials having pores in their structure in the form of intermolecular space, as for example, concrete, mortar, burnt clay bricks, some stones, timber, etc. expand on absorbing moisture and shrink on drying. These movements are reversible, that is, cyclic in nature and are caused by increase or decrease in the inter-pore pressure with moisture changes, extent of movement depending on molecular structure and porosity of a material.

2.1.2 Apart from reversible movement, certain materials undergo some irreversible movement due to initial moisture changes after their manufacture or construction. Instances of irreversible movement in materials are: shrinkage of cement and lime-based materials on initial drying, and expansion in burnt clay bricks and other clay products on removal from kilns.

2.2 Reversible Movement

2.2.1 From consideration of moisture movement of reversible nature, materials could be broadly classified as under:

- a) Materials having very small moisture movement, as for example, burnt clay bricks, igneous rocks, limestones, marble, gypsum plaster, metals, etc. The use of these materials does not call for much precautions.
- b) Materials having small to moderate moisture movement, as for example, concrete, sand-lime bricks, sandstones, cement and lime mortars, etc. In the use of these materials some precautions in design and construction are necessary.
- c) Materials having large moisture movement, as for example, timber, block boards, plywoods, wood-cement products, fibrous boards, asbestos cement sheets, etc. For these materials, special techniques of treatment at joints and surrounds, and protective coats on surface are required (as indicated subsequently in Table 2).

2.2.2 Based on research findings in UK, range of reversible moisture movement of some of the commonly used building materials is given in Table 1.

TABLE 1 MOISTURE MOVEMENT OF SOME COMMON BUILDING MATERIALS*

Sl. No.	MATERIAL	MOISTURE MOVEMENT (DRY TO SATURATION) PERCENT
(1)	(2)	(3)
i)	Burnt clay bricks, limestone	0.002 to 0.01
ii)	Hollow clay bricks, terra cotta	0.006 to 0.016
iii)	Expanded clay concrete, cinder concrete	0.017 to 0.04
iv)	Sandstone, sand-lime bricks, concrete blocks	0.01 to 0.05
v)	Foam cellular concrete	0.04 to 0.05
vi)	Cast-stone, dense concrete, cement lime mortars	0.02 to 0.06
vii)	Auto-claved aerated concrete, clinker concrete	0.03 to 0.08
viii)	Marble	Negligible
ix)	Wood along grain	0.0008
x)	Wood across grain—tangential	5 to 15
xi)	Wood across grain—radial	3 to 5

NOTE: Initial drying shrinkage in cement and lime products which is partly irreversible is 50 percent more than the values of reversible shrinkage given above.

*Data for items (i) to (vii) are reproduced from 'Principles of modern buildings', Vol I and for items (viii) to (xi) from 'Common defects in buildings'¹¹

2.3 Initial Shrinkage

2.3.1 Initial shrinkage, which is partly irreversible, normally occurs in all building

materials or components that are cement/lime-based, for example, concrete, mortar, masonry units, masonry and plasters. This shrinkage is one of the main causes of cracking in structures.

2.3.2 Hardening process of cement-based products depends on chemical action in which moisture plays an important role. After mixing and placement, moisture contained in the product gradually dries out. In the first instance, moisture present in the intermolecular space (absorbed moisture) dries out, causing some reduction in volume and shrinkage. This shrinkage, which is reversible in nature, has been discussed earlier. After capillary water is lost, calcium silicate gel crystallizes and gives up some moisture (absorbed moisture) and individual molecules undergo reduction in size, resulting in shrinkage which is of irreversible nature. While all porous materials keep on undergoing reversible expansion and contraction with changes in moisture content throughout their life time, the irreversible component of initial shrinkage in case of cement/lime-based products takes place only once in their life time at the time of manufacture or construction when moisture used in the process of manufacture or construction dries out. Initial shrinkage in cement products is about 50 percent greater than that due to subsequent wetting and drying from saturation to dry state. Since subsequent wetting does not, in most of the cases, result in complete saturation of a component, as happens at the time of original manufacture or construction, initial drying shrinkage of concrete and mortar far exceeds any subsequent reversible movement and is very significant. Thus, most of the cracking in these materials occurs due to shrinkage at the time of initial drying.

2.3.3 Initial shrinkage in cement concrete and cement mortar depends on a number of factors, namely cement and water content; maximum size; grading and quality of aggregates; use of calcium chloride as accelerator; duration, method and temperature of curing; presence of excessive fines in aggregates; relative humidity of surroundings; chemical composition of cement; temperature of fresh concrete; etc. Influence of these factors on shrinkage is as follows:

a) **Cement content** — As a general rule, richer the mix, greater the drying shrinkage. Conversely, larger the volume of aggregate in concrete, lesser the shrinkage. For the range of aggregate content generally used for structural concretes, increasing the volume of aggregates by 10 percent can be expected to reduce shrinkage by about 50 percent¹⁵. Relation between mix

proportion and shrinkage is depicted in Fig. 5¹⁷

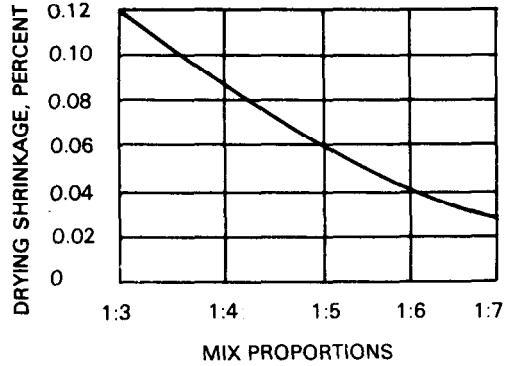

(Reproduced from 'Principles of Modern Buildings Vol.17')

Fig. 5 Relation Between Mix Proportions and Drying Shrinkage of Cement Concrete/Mortar

b) **Water content** — Greater the quantity of water used in the mix, greater the shrinkage. Thus a wet mix has more shrinkage than a dry mix which is otherwise similar. That explains why a vibrated concrete, which has low slump, has lesser shrinkage than a manually compacted concrete, which needs to have greater slump. In terrazzo and concrete floors, use of excess water in the mix (commonly resorted to by masons to save time and labour on compaction and screeding) is one of the principal causes of cracking in such floors. A typical relation between water content and drying shrinkage is shown in Fig. 6.

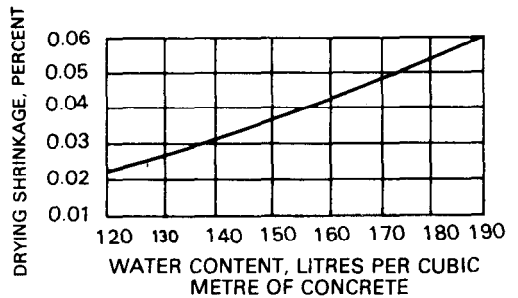

(Based on graph given in 'Control of Cracking in Concrete Structures')

Fig. 6 Effect of Variation in Water Content of Concrete on Drying Shrinkage

c) **Aggregates** — By using the largest possible maximum size of aggregate in concrete and ensuring good grading, requirement of water for concrete of desired workability is reduced and the concrete thus obtained has less shrinkage because of reduction in the porosity of hardened concrete. Any water in concrete mix in excess of that required for hydration of

cement, to give the desired workability to the mix, results in formation of pores when it dries out, thus causing shrinkage. Figure 7 illustrates the effect of aggregate size on water requirement⁵.

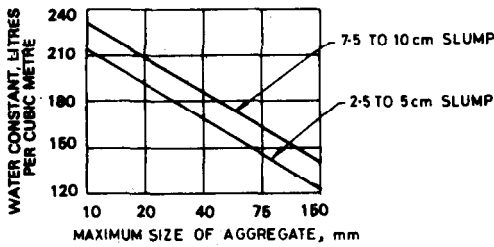

Fig. 7 Effect of Aggregate Size on Water Requirement of Concrete

For the same cement-aggregate ratio, shrinkage of sand mortars is 2 to 3 times that of concrete using 20 mm maximum size aggregate and 3 to 4 times that of concrete using 40 mm maximum size aggregate¹⁵. For the same reason, concretes and mortars having excessive fines will have greater shrinkage than those having just adequate amount of fines needed for good grading. Similarly, over-sanded mixes of concrete, which are preferred over concretes for ease in laying, will have greater shrinkage. Aggregates that are porous and themselves shrink on drying result in concrete which has greater shrinkage. Examples of porous aggregates are: sandstone, clinker, foamed slag, expanded clay, etc. Aggregates made from limestone, quartzite, granite and dolomite are considered to be non-porous and those made from basalt—semi-porous. Light-weight aggregates, which have generally very high porosity, are thus prone to high shrinkage.

- d) *Use of accelerators*—Use of calcium chloride as accelerator in concrete appreciably shrinkage increases—being up to 50 percent with 0.5 to 2.0 percent addition of calcium chloride. Shrinkage could be much more if proportion of calcium chloride is higher²⁰. Moreover, it has some corrosive effect on reinforcement in concrete.
- e) *Curing*—Curing also plays an important part in limiting shrinkage. If proper curing is started as soon as initial set has taken place and it is continued for at least 7 to 10 days, drying shrinkage is comparatively less, because when hardening of concrete takes place under moist environments, there is initially some expansion which offsets a part of subsequent shrinkage. Steam curing of concrete blocks at the time of manufacture reduces their liability to shrinkage as high temperature results in

precarbonation. This has been discussed subsequently in 6.3.

- f) *Presence of excessive fines*—Presence of excessive fines—silt, clay, dust—in aggregates has considerable effect on extent of shrinkage in concrete. Presence of fines increases specific surface area of aggregates and consequently the water requirement. Rightly, therefore, specifications for fine and coarse aggregates for concrete lay much emphasis on cleanliness of aggregates and stipulate a limit for the maximum percentage of fines in aggregates which is 3 percent for coarse as well as uncrushed fine aggregate according to IS : 383-1970³⁴
- g) *Humidity*—Extent of shrinkage also depends on relative humidity of ambient air. Thus, shrinkage is much less in coastal areas where relative humidity remains high throughout the year. Low relative humidity may also cause plastic shrinkage in concrete as discussed later in 2.3.4.
- h) *Composition of cement*—Chemical composition of cement used for concrete and mortar also has some effect on shrinkage. It is less for cements having greater proportion of tricalcium silicate and lower proportion of alkalis like sodium and potassium oxides. Rapid hardening cement has greater shrinkage than ordinary Portland cement.
- j) *Temperature*—An important factor which influences the water requirement of concrete and thus its shrinkage is the temperature of fresh concrete. This is illustrated in Fig. 8 based on studies made by Bureau of Reclamation, USA⁵.

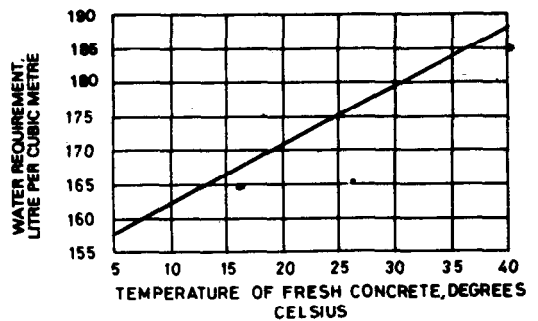

Fig. 8 Effect of Temperature of Fresh Concrete on Water Requirement

If temperature of concrete gets lowered from 38°C to 10°C it would result in reduction of water requirement to the extent of about 25 litres per cubic metre of concrete for the same slump. It, thus, follows that in a tropical country like India, concrete work done in mild winter

months would have much less tendency for cracking than that done in hot summer months. Any practice which increases water requirement of concrete, namely, high slump, use of small size of aggregate, excessive fines and high temperature, will increase drying shrinkage and consequent cracking. In hot weather, use of warm aggregates and warm water should be avoided in order to keep down the temperature of fresh concrete. Aggregates and mixing water should, therefore, be shaded from direct sun. If need arises, a part of mixing water could be replaced by pounded ice. Where feasible, concreting should be done during early hours of the day when aggregates and mixing water are comparatively cool and sun rays are slanting.

2.3.4 In freshly laid cement concrete pavements and slabs, sometimes cracks occur before concrete has set due to plastic shrinkage. This happens if concrete surface loses water faster than bleeding action brings it to top. Quick drying of concrete at the surface results in shrinkage and as concrete in plastic state cannot resist any tension, short cracks develop in the material. These cracks may be 5 to 10 cm in depth and their width could be as much as 3 mm². Once formed these cracks stay and may, apart from being unsightly affect serviceability of the job.

In order, to prevent plastic shrinkage of concrete, it is necessary to take steps so as to slow down the rate of evaporation from the surface of freshly laid concrete. Immediately after placing of concrete, solid particles of the ingredients of concrete begin to settle down by gravity action and water rises to the surface. This process — known as bleeding — produces a layer of water at the surface and continues till concrete has set. As long as rate of evaporation is lower than the rate of bleeding, there is a continuous layer of water at the surface, as evidenced by the appearance of a 'water sheen' on the surface and shrinkage does not occur.

Rate of evaporation from the surface of concrete depends on temperature of concrete, gain of heat from sun's radiation, relative humidity of ambient air and velocity of wind playing over the concrete surface. It could be curtailed by adopting measures as suggested in 2.3.3(j), by resorting to fog spray over the surface of concrete or by covering the job by wet burlap when relative humidity is very low and by providing wind breaks when weather is windy and dry.

2.3.5 For concrete and mortar using hydraulic lime, factors affecting shrinkage are the same as those for cement based products. In case of concrete and mortar using fat lime,

its setting action is due to chemical combination of carbon dioxide from the atmosphere with calcium hydroxide, forming calcium carbonate and water, and shrinkage is caused on drying because calcium carbonate occupies lesser volume than calcium hydroxide.

2.3.6 Shrinkage due to carbonation occurs to some extent in cement concretes and mortars also, because some lime (calcium hydroxide) is liberated as a result of hydration of cement and carbon dioxide from atmosphere reacts with it. Shrinkage due to this factor, however, is not of much significance in good quality dense concrete because carbonation is confined only to a thin surface layer. Extent of carbonation and consequent shrinkage in case of light-weight concrete blocks, however, is quite appreciable, as discussed subsequently in 6.5.4.

2.3.7 In cement concrete, one-third of shrinkage takes place in the first 10 days, half within one month and the remaining half in about a year. Shrinkage cracks in concrete may thus continue to occur and widen up to about a year.

2.4 Initial Expansion

2.4.1 When clay bricks (or other clay products) are fired, because of high temperature (900°C to 1000°C), not only intermolecular water but also water that forms a part of the molecular structure of clay, is driven out. After burning, as the temperature of bricks falls down, the moisture-hungry bricks start absorbing moisture from the environment and undergo gradual expansion, bulk of this expansion being irreversible. Extent of irreversible expansion depends on the nature of soil, that is, its chemical and mineralogical composition and the maximum temperature of burning. When bricks are fired at very high temperature, as in the case of engineering bricks, because of fusion of soil particles, there is discontinuity in the pores and as a result, water absorption and moisture movements are less.

2.4.2 While the reversible part of expansion, which depends upon porosity and surface area of soil particles, does not change with time, the irreversible part occurs only once in the life cycle of the burnt clay products. It does not depend on extent of wetting and its pace cannot be accelerated by immersion in water. Also it is not reversed if brick or brickwork subsequently dries out. Though this expansion continues for many years, its rate, which is very high in the beginning, rapidly drops down after a few weeks, and for all practical purposes, it could be assumed that

almost entire expansion takes place in the first 3 months.

2.4.3 There is considerable variation in the behaviour of bricks of different origins in regard to initial expansion. According to some experiments conducted in UK, a typical brick has an irreversible expansion of 0.08 percent in the first 8 years, 50 percent of which takes place in the first week itself. Compared to this, reversible expansion is of the order of 0.02 percent only. Irreversible expansion in brickwork has been found to be about 0.05 percent, that is, about 60 percent of that of bricks. If bricks are used in masonry soon after unloading from the kiln, brickwork will, in course of time, expand and may crack. Some cases of cracking of brick structures due to this cause have been identified in USA and some other countries.

2.4.4 To avoid cracks in brickwork on account of initial expansion, a minimum period varying from 1 week to 2 weeks is recommended by authorities for storage of bricks after these are removed from kilns^{11, 14, 16}. In India, though no research on this phenomenon of bricks seems to have been done so far, it is desirable to allow a minimum period of 2 weeks in summer and 3 weeks in winter, between removal of bricks from kilns and their use in masonry.

2.4.5 An example of expansion in external wall of brickwork, when there is a short return wall resulting in cracking, is illustrated in Fig. 9.

Walls 'A' and 'C' on expanding cause rotation of wall 'B' and vertical cracks at 'X'. Such cracks could be avoided if it is ensured that return wall is not less than 60 cm in length (that is, length of 3 bricks) as in that case movement of long walls gets accommodated in the joints between units of the return wall.

2.5 Measures for Controlling Cracks Due to Shrinkage

2.5.1 Shrinkage on account of drying out of moisture content in building materials/components is one of the main causes of cracking in structures, and it is thus a matter which deserves special attention. Cracking due to shrinkage normally affects mainly the appearance and finish and structural stability is not impaired. Most of the unsightly cracks usually develop in the first dry spell after the completion of a building.

2.5.2 Shrinkage in a material induces tensile stress when there is some restraint to movement, as is generally the case. When the stress exceeds the strength, cracking occurs, thus relieving the stress. Cracks in walls

generally get localized at weak sections, such as door and window openings or staircase walls. In external walls of buildings, shrinkage cracks generally run downward from window sill to plinth level and from window sill on an upper storey to the lintel of a lower storey.

2.5.3 Shrinkage cracks in masonry could be minimized by avoiding use of rich cement mortar in masonry and by delaying plaster work till masonry has dried after proper curing and has undergone most of its initial shrinkage. Masonry work done with composite cement-lime-sand mortars (1:1:6, 1:2:9 or 1:3:12 depending on requirements) which are weak, will have lesser tendency to develop cracks, because shrinkage in individual masonry units gets accommodated to a great extent in the mortar when these are laid in weak mortar.

2.5.4 In all concrete jobs, some precautions are necessary to limit the drying shrinkage. Factors which affect shrinkage have been discussed earlier in 2.3.3. Construction based on use of precast components has a distinct advantage over *in-situ* concrete job since initial shrinkage is made to take place without any restraint prior to incorporation of the components in a building, thus obviating subsequent shrinkage. Use of precast tiles in case of terrazzo flooring is an example of this measure. In case of *in-situ*/terrazzo flooring, cracks are controlled by laying the floor in small alternate panels or by introducing strips of glass, aluminium or some plastic material at close intervals in a grid pattern, so as to render the shrinkage cracks imperceptibly small.

2.5.5 In case of structural concrete, shrinkage cracks are controlled by use of reinforcement, commonly termed as 'temperature reinforcement'. For plain concrete walls (that is, walls which are not reinforced to take any forces due to loading), Indian Standard Code¹⁹ recommends a minimum reinforcement of 0.25/0.20 percent in the horizontal direction and 0.15/0.12 in the vertical direction when using plain/deformed bars. This reinforcement is intended to control shrinkage as well as temperature effect in concrete and is more effective if bars are small in diameter and are thus closely spaced, so that, only thin cracks which are less perceptible, occur. In case of basement floors subject to water pressure, since laying of floors in panels is not feasible as water would seep out from joints, shrinkage cracking in concrete has to be controlled with the help of reinforcement.

2.5.6 Coat of rendering or plastering on masonry is restrained from shrinkage to some extent by its adhesive bond to non-shrinking

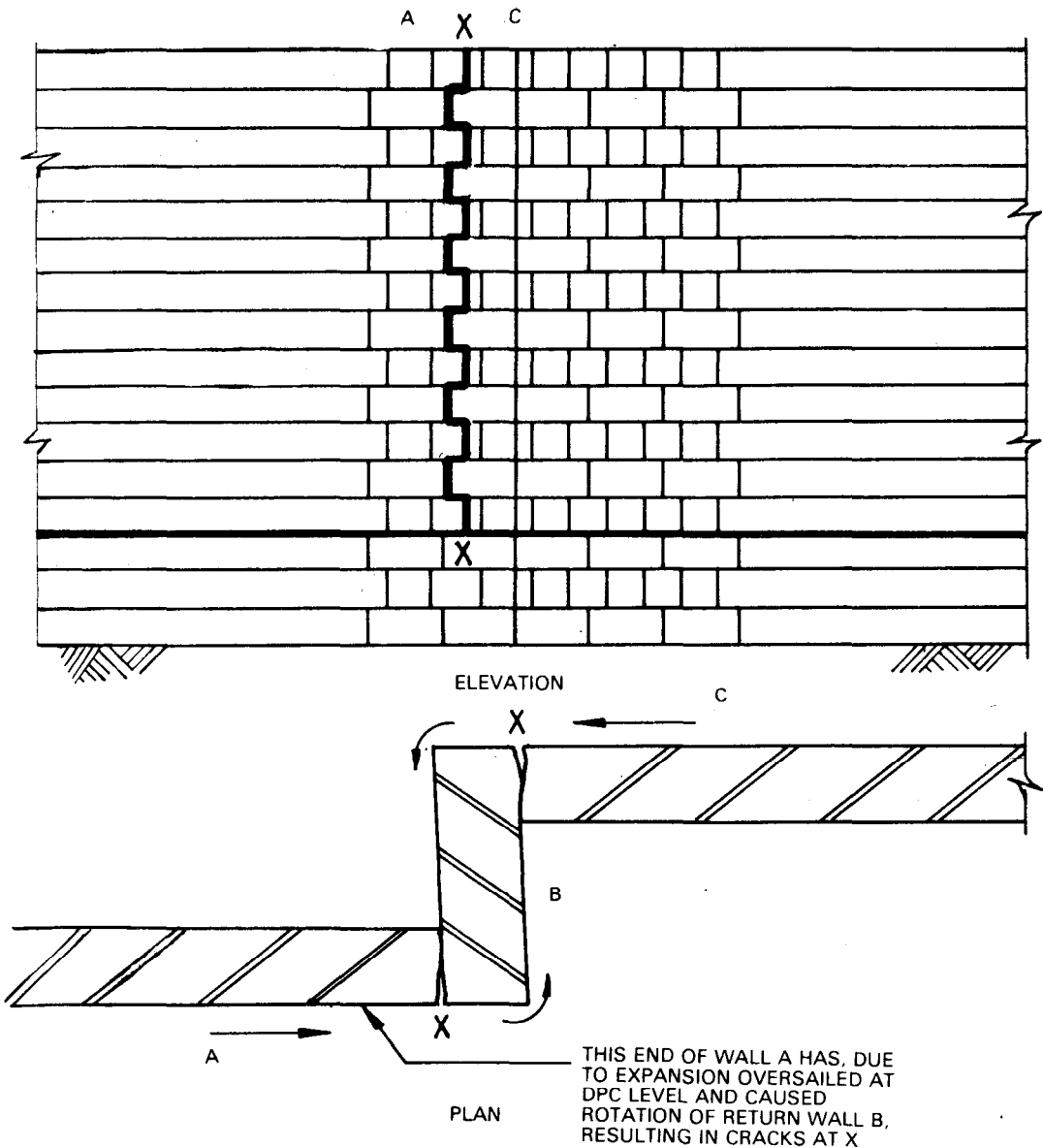

Fig. 9 Cracking Due to Expansion of Brickwork

background, the later having already undergone shrinkage. To limit these cracks so that these are not unsightly, it is necessary that adhesion should be uniform and good so that shrinkage is well distributed in thin cracks. One can thus appreciate the importance of raking of joints in masonry to be plastered so as to provide a good key between plaster and masonry. The background should also be strong enough to stand the force of shrinkage and plaster should not be stronger than the background. Shrinkage of a rich and strong mortar is known to exert sufficient force to tear off the surface layer of weak bricks.

To minimize shrinkage cracks in rendering/plastering, mortar for plaster should not be richer than what is necessary from consideration of resistance to abrasion and durability. Composite cement-lime mortar of 1:1:6 mix or weaker for plaster work is less liable to develop shrinkage cracks, as compared to plain cement mortar and should thus be preferred. For reasons explained earlier in 2.3.3, plaster with coarse well graded sand or stone chips (rough cast plaster) will suffer from less shrinkage cracks, and hence the superiority of such plasters for external face of walls, from consideration of

cracking and resistance against penetration of moisture through walls.

In case of rendering or plastering on concrete, better adhesion or bond is obtained if, where feasible, rendering/plastering is done as soon as possible after removal of shuttering; concrete surface is roughened where necessary by hacking, and neat cement slurry is applied to concrete just before rendering, plastering.

2.5.7 Sometimes, on architectural considerations, external walls of buildings are given on the outside a finish of some rich cement-based material, for example, terrazzo, pebble dash or artificial stone. In such cases, in order to avoid shrinkage cracks, the finish is divided into small panels of dimensions varying between 0.5 to 1.0 metre by providing grooves of 8 to 10 mm width in both directions.

2.5.8 Considering a building or a structure as a whole, an effective method of controlling shrinkage cracks, as also cracks due to other causes, is the provision of movement joints, that is, expansion, control and slip joints as discussed in Section 3.

2.5.9 It will be of interest to note that work done in cold weather will be less liable to shrinkage cracking than that done in hot weather, since movement due to thermal expansion of materials will be opposite to that due to drying shrinkage.

2.5.10 Some general precautions that should be taken for minimizing shrinkage cracks in case of materials that are commonly used in buildings are summarized in Table 2.

TABLE 2 GENERAL PRECAUTIONS FOR AVOIDING OF SHRINKAGE CRACKS IN THE USE OF SOME COMMON BUILDING MATERIALS**

Sl. No.	MATERIAL	EXTENT OF MOISTURE MOVEMENT	PRECAUTIONS IN USE
(1)	(2)	(3)	(4)
i)	Burnt clay bricks and other clay products Igneous rocks limestone	Small; under-burnt bricks have greater moisture movement than well-burnt bricks	Though these materials themselves have small shrinkage, cement, lime mortar used in masonry with these materials undergoes some shrinkage and thus certain precautions are necessary. Bricks should be well burnt; do not use very strong mortars and do plastering where required, after proper curing and adequate drying of masonry (see Note).
ii)	Sandstones	Appreciable; may vary with different types	Exercise some discrimination in choice of stone for masonry. When using sandstone having appreciable moisture movement do not use rich cement mortar and provide control joints at regular intervals.
iii)	Cement concrete and cement mortar	Appreciable; may vary considerably	Factors influencing shrinkage of concrete and mortars have been discussed in 2.3.3. Precautions as mentioned in that para should be taken to avoid or minimize shrinkage cracks. Construction joints in concrete where unavoidable should be provided with care as otherwise cracks are likely to develop due to shrinkage at construction joints ²⁴ .
iv)	Blocks of normal or light weight concrete, sand-lime bricks	Appreciable; may vary with mix, method of manufacture and amount of moisture contained in the blocks at the time of laying	Units should comply with standards issued by ISI; these should be allowed to mature and dry before use (allow time lag of at least one month after manufacture) and should be protected from getting wet at site due to rain; work in progress should be protected in wet weather; units should only be lightly wetted before use; use of strong and rich mortars for laying units should be avoided; mortar should have high water retentivity; thus cement-lime composite mortars should be preferred; use 1 cement : 2 lime : 9 sand mortar for work done in summer and 1 cement : 1 lime : 6 sand mortar for work done in winter that is in cold weather ⁴⁰ .

If wall exceeds 6 to 8 m in length, provide control joints at weak sections (see 3.11.3). Curing of masonry should be done sparingly so as to avoid body of the blocks getting wet. Masonry should be allowed to dry and undergo initial shrinkage before plastering. Avoid excessive wetting of masonry at the time of plastering so that moisture does not reach the body of the blocks. For curing of plaster, heavy watering of walls should be avoided and instead these should be lightly sprayed with water.

*Some of the recommendations contained in this Table are from 'Principles of modern buildings' Vol. 1¹⁷.

(Continued)

TABLE 2 GENERAL PRECAUTIONS FOR AVOIDING OF SHRINKAGE CRACKS IN THE USE OF SOME COMMON BUILDING MATERIALS—CONTD.

Sl. No.	MATERIAL	EXTENT OF MOISTURE MOVEMENT	PRECAUTIONS IN USE
(1)	(2)	(3)	(4)
v)	Wood-wool slabs	Considerable	Avoid use of this material in external panels; even in internal panels, it is necessary to conceal shrinkage by suitable joint treatment.
vi)	Asbestos cement sheets	Considerable	Protect both surfaces with paint ³⁹ .
vii)	Timber	Considerable	Timber, before use should be seasoned to a moisture content that is appropriate to the conditions at which equilibrium will ultimately be reached in the building. As far as possible, door and window frames should not, on either side, be fitted flush with a wall surface. Where unavoidable, either conceal the junction with an architrave or provide the frame of shape and design as shown in Fig. 10. In joinery work avoid use of planks in panels wider than 25 cm, where unavoidable make use of plywood panel or block-board construction for internal work. Protect all surfaces of wood work by paint, enamel, polish or varnish, etc.
viii)	Block-boards and plywood	Considerable	Confine their use to internal locations and dry situations; protect all surfaces including edges by painting.

NOTE—To avoid cracking in brick masonry due to initial expansion, burnt clay bricks should be exposed to atmosphere after unloading from kilns for a minimum period of 2 weeks in summer and 3 weeks in winter before use.

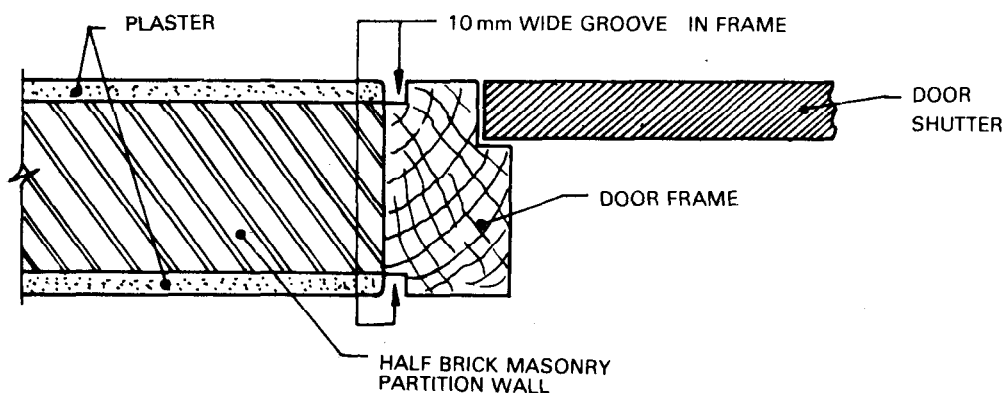

Fig. 10 Arrangement Showing Fixing of Door Frame Flush with Wall Surface on Both Sides

SECTION 3 THERMAL MOVEMENT

3.1 It is a well known phenomenon of science that all materials, more or less, expand on heating and contract on cooling. Magnitude of movement, however, varies for different materials depending on their molecular structure and other properties. When there is some restraint to movement of a component of a structure, internal stresses are set up in the component, resulting in cracks due to tensile or shear stresses. In extreme cases, stresses due to changes in temperature may exceed those due to loading; thermal movement is

thus one of the most potent causes of cracking in buildings and calls for serious consideration.

3.2 While diurnal changes/variations in temperature are due to rotation of the earth round its own axis once in every 24 hours, seasonal changes are due to variations in the angle of incidence of the sun rays, as well as their duration, and the cycle extends over a year. Seasonal changes are practically negligible near the equator, and go on intensifying as one moves away from the equator. Seasonal as well as diurnal changes

are very mild in coastal areas because of tempering effect of the sea and humid atmosphere. In India, diurnal and seasonal changes are generally of the order of 5°C to 20°C and 0°C to 25°C, respectively. Daily changes which are rapid, have much greater damaging effect on account of movement than seasonal changes, which are gradual because in the latter case, stress gets relieved to a considerable extent on account of creep.

3.3 Extent of thermal movement in a component depends on a number of factors, such as temperature variation, dimensions, co-efficient of expansion and some other physical properties of the materials. Co-efficients of thermal expansion of some of the common building materials are given in Table 3.

TABLE 3 CO-EFFICIENT OF THERMAL EXPANSION OF SOME COMMON BUILDING MATERIALS (WITHIN THE RANGE 0°C TO 100°C)*

Sl No.	MATERIAL	CO-EFFICIENT OF THERMAL EXPANSION 10 ⁻⁶ PER °C
(1)	(2)	(3)
i)	Bricks and brickwork	5 to 7
ii)	Cement mortar and concrete	10 to 14
iii)	Sand-lime bricks	11 to 14
iv)	Stones:	
	a) Igneous rocks (granite, etc)	8 to 10
	b) Limestones	2.4 to 9
	c) Marble	1.4 to 11
	d) Sandstones	7 to 16
	e) Slates	6 to 10
v)	Metals:	
	a) Aluminium	25
	b) Bronze	17.6
	c) Copper	17.3
	d) Lead	29
	e) Steel and iron	11 to 13
vi)	Wood	

NOTE: Thermal co-efficient for brickwork as given above is for movement in horizontal direction; for movement of brickwork in the vertical direction, co-efficient is 50 percent higher¹⁶.

* Data contained in this Table is from 'Principles of modern buildings', Vol. I¹⁷ excepting item (iii), which is from the 'Performance of high rise masonry structures'¹⁶ and item (vi) which is from 'Thermal movements and expansion joints in buildings'¹⁷.

3.4 Co-efficient of thermal expansion of brickwork in a building in the vertical direction is 50 percent¹⁶ greater than that in the horizontal direction because, firstly there is no restraint to movement in vertical direction, secondly there is no scope for any inter-adjustment of movement between bricks and mortar, and thirdly compared to the horizontal direction, proportion of mortar which has higher thermal co-efficient than brick is greater. Expansion of brickwork in

the vertical direction is reversible, but in the horizontal direction it is reversible only if the structure does not crack, since cracks generally get filled up with dust, etc, and do not close with drop in temperature. For a brick masonry wall of 10 m length, variation in length between summer and winter could be of the order of 2 mm.

3.5 Other factors which influence the thermal movement of component are: colour and surface characteristics, thermal conductivity, provision of an insulating or protective layer and internally generated heat, as discussed below:

a) *Colour and Surface Characteristics*— Dark coloured and rough textured materials have lower reflectivity than light coloured and smooth textured materials and thus, for the same exposure conditions, gain of heat and consequently rise in temperature of the former is more. As an example, a black coloured panel exposed to sun under certain circumstances (in Great Britain) could reach a temperature of as much as 70°C¹⁷. It has also been reported by a research authority that surface of one experimental roof slab was 14°C hotter than bottom of the slab and it was found that flexural deformation associated with this thermal gradient was completely removed when the upper surface of the slab was painted white. In Western India, it has been a common practice—and a very successful one—of laying a layer of broken china in lime mortar over lime concrete terrace (known as 'China mosaic') which, because of its high reflectivity co-efficient reduces heat load on the roof and at the same time gives a good wearing and draining surface on the terrace.

Reflectivity co-efficients of some of the commonly used building materials are given in Table 4.

TABLE 4 HEAT REFLECTIVITY CO-EFFICIENT OF SOME COMMON BUILDING MATERIALS*

Sl No.	MATERIAL	REFLECTIVITY CO-EFFICIENT
(1)	(2)	(3)
i)	Asphalt	0.09 to 0.17
ii)	GI sheets	0.10 to 0.36
iii)	Asbestos cement sheets	0.29 to 0.58
iv)	Brickwork (exposed)	0.30 to 0.58
v)	Cement mortar and concrete	0.34 to 0.65
vi)	Granite (reddish)	0.45
vii)	Aluminium paint	0.46
viii)	Aluminium sheets	0.47
ix)	Marble (white)	0.56
x)	White paint	0.71
xi)	Whitewash	0.79 to 0.91

*Based on data contained in 'Principles of modern buildings', Vol II¹⁸, and 'Thermal movements and expansion joints in buildings'¹⁷.

- b) *Thermal Conductivity*—Low thermal conductivity of a component which is subject to solar radiation produces a thermal gradient in the component, resulting in warping of the component. In case of concrete roof slabs, as the material has low conductivity, thermal gradient is quite appreciable and that causes the slab to arch up and also to move outward due to heat from the sun. This results in cracks in external walls which support the slab and in the internal walls that are built up to the soffit of the slab. It is thus very necessary to provide a layer of adequate thickness of a suitable material preferably with a good reflective surface over concrete roof slab in order to minimize cracking in walls.
- c) *Provision of an Insulating or Protective Layer*—If there is a layer of an insulating or heat absorbing material acting as protective cover to a component, shielding it from sun rays, heat gain or loss of the component is considerably reduced and thus its thermal movement is lessened. It is a common practice in hot countries like India, to provide such a layer over flat roofs of buildings. In air-conditioned buildings, this layer may consist of light-weight concrete cork or such other insulating material, while in ordinary buildings, which are not air-conditioned it may consist of 10 to 15 cm thick layer of lime concrete or well compacted earth (with or without a wearing coat of brick tiles) laid to slope. Whereas light-weight concrete or cork function through their insulating property, lime concrete and earth function through their good heat storing property. In the latter case, because of cyclic nature of heat load and time lag in the transmission of heat, temperature on the underside of the roof slab remains fairly even during day and night. Such a layer, apart from reducing heat load on the upper storey of a building reduces thermal movement of the roof (thereby reducing its liability to cracking) and in addition facilitates roof drainage.
- d) *Internally Generated Heat*—Rise of temperature in fresh concrete can take place not only due to heat gained from an external source but also due to heat generated within the material by hydration of cement. Extent of rise of temperature due to heat of hydration would depend on the properties of cement used as well as the shape and size of the component. Loss of heat by radiation into the atmosphere depends on the proportion of exposed surface to volume of the component. For instance, if under certain conditions, in a 15 cm thick concrete wall, 95 percent of heat is lost to

the air in $1\frac{1}{2}$ hour, under similar circumstances, same amount of heat will be lost in about one week when the wall is 1.5 m thick, and in about 2 years when the wall is 15 m thick¹. This comparison is given to bring out the effect of surface-to-volume ratio on dissipation of internally generated heat in concrete. Though in concreting jobs of buildings and ordinary pavements, rise in temperature of fresh concrete due to heat of hydration is not significant, in case of dams and such other massive structures, heat of hydration could result in appreciable rise of temperature which could be as much as 25°C.

With the rise in temperature, fresh concrete expands, but as it is in a plastic state at that stage, very little stress is set up in the material due to this expansion. However, later on, when cooling takes place and concrete has hardened by that time, shrinkage occurs and concrete cracks. Thus, heat of hydration in massive structures like dams is an important factor to be contended with. To prevent cracking in such cases, special measures are called for which include use of low-heat cement, use of pozzolanas, pre-cooling of aggregates and mixing water, post-cooling of concrete by circulating refrigerated water through pipes embedded in the body of the concrete, etc.

3.6 Very large forces could be brought into play if expansion of a beam or slab is restrained and cases of severe damage to buildings in a hot country like India are not uncommon. The magnitude of force due to thermal expansion when restrained may be appreciated from the fact that a force of 500 kN is necessary to restrain the expansion of a strip of concrete 1 m wide, 0.1 m thick heated through 22°C¹⁶. It is, therefore, important to make provision for unrestrained movement (to the extent it is feasible) of concrete beams and slabs at the supports.

3.7 Generally speaking, thermal variations in the internal walls and intermediate floors are not much and thus do not cause cracking. It is mainly the external walls, especially thin walls exposed to direct solar radiation and the roof, which are subject to substantial thermal variation and are thus liable to cracking.

3.8 Cracks due to thermal movement could be distinguished from those due to shrinkage or other causes from the criterion that the former open and close alternately with changes in temperature while the latter are not affected by such changes. When a concrete job has high drying shrinkage and is done in summer, that is, when ambient temperature is high, contraction due to drop in temperature

in winter and drying shrinkage act in unison and there is a possibility of greater cracking. However, requirement of gap width for expansion joint in such a case gets reduced. In contrast to this, a concrete job done in winter that is cold weather is less liable to cracking but requires wider expansion joints.

3.9 In order to bring out the importance of thermal movement in structures and measures that should be adopted to prevent cracking due to these factors, it will be of interest to give

here a few examples of common occurrence of cracks due to this factor:

- a) In load-bearing structures, when a roof slab undergoes alternate expansion and contraction due to gain of heat from the sun and loss of heat by radiation into the open sky, horizontal cracks may occur (that is shear cracks) in cross walls as shown in Fig. 11 (see also Photo 1). If movement of slab is restrained on one side by some heavy structure and

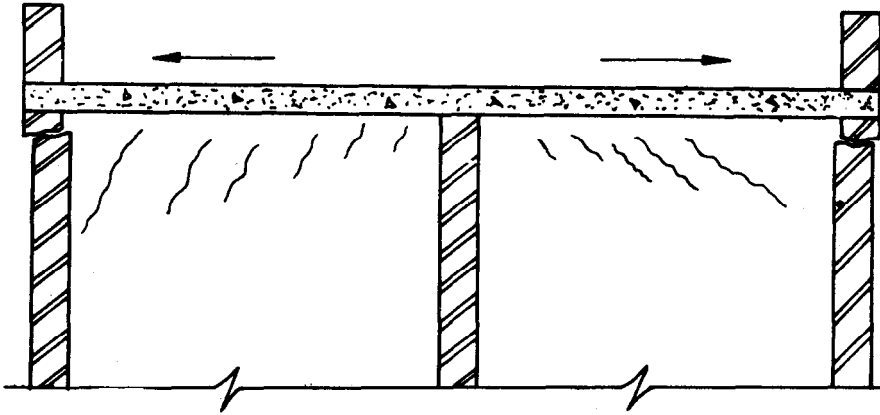

Fig. 11 Cracking in Top Most Storey of a Load Bearing Structure

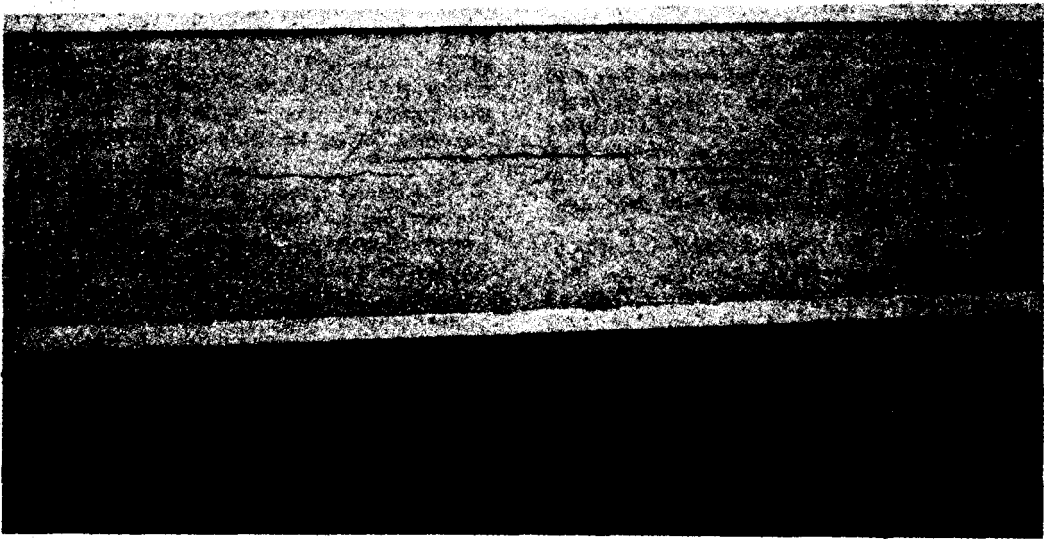

Photo 1 Horizontal Crack at the Support of an RCC Roof Slab due to Thermal Movement of Slab

insulation or thickness of protective cover on the roof is inadequate, cracking will be much more severe. To prevent cracks in such situations, a slab should be provided with adequate insulation or protective cover on the top, span of slab should not be very large, slip joint should be introduced between slab and its supporting wall as well as between slab and cross walls and further either the slab should project for some length from the supporting wall or the slab should bear only on part width of the wall as shown in Fig. 12. On the inside, wall plaster and ceiling plaster should be made discontinuous by a groove about 10 mm in width as shown in Fig. 12.

- b) In case of framed-structures, roof slab, beams and columns move jointly causing diagonal cracks in walls which are located parallel to the movement, and horizontal cracks below beams in walls which are at right angle to the movement. This is shown in Fig. 13. Extent of movement in a framed-structure, however, is comparatively less because columns, on account of their stiffness and ability to take tension due to bending, are able to resist and contain the movement to some extent. Both in load-bearing as well as framed-structures, provision of adequate insulation or protective cover on the roof slab is very important in order to avoid cracks in walls.
- c) Figure 14 shows a long garden wall built between two buildings. In the absence of any provision for expansion of stone

coping, it arches up in the middle causing horizontal cracks as shown. Provision for expansion of coping should have been made by introducing expansion joints, that is gaps in the coping on both ends as well as at regular intervals (say 4 to 5 m) in between.

- d) An instance of very frequent occurrence of thermal cracks (combined with shrinkage) in buildings, is the formation of horizontal cracks at the support of a brick parapet wall or brick-cum-iron railing over an RCC cantilevered slab, that is balcony as shown in Fig. 15 (see also Photo 2 and 3)

Factors which promote this type of cracking are: (1) thermal co-efficient of concrete is twice that of brickwork and thus differential expansion and contraction cause a horizontal shear stress at the junction of the two materials; (2) balcony slab as well as parapet masonry are both very much exposed and are thus subject to wide range of temperature variations; (3) drying shrinkage of concrete is 3 to 4 times that of brick masonry; (4) parapets are generally built over the concrete slab before the latter has undergone its drying shrinkage fully; and (5) parapet or railing does not have much self-weight to resist horizontal shear force at its support caused by differential thermal movement and differential drying shrinkage. In case of brick masonry parapets over RCC slabs, there is no simple solution for

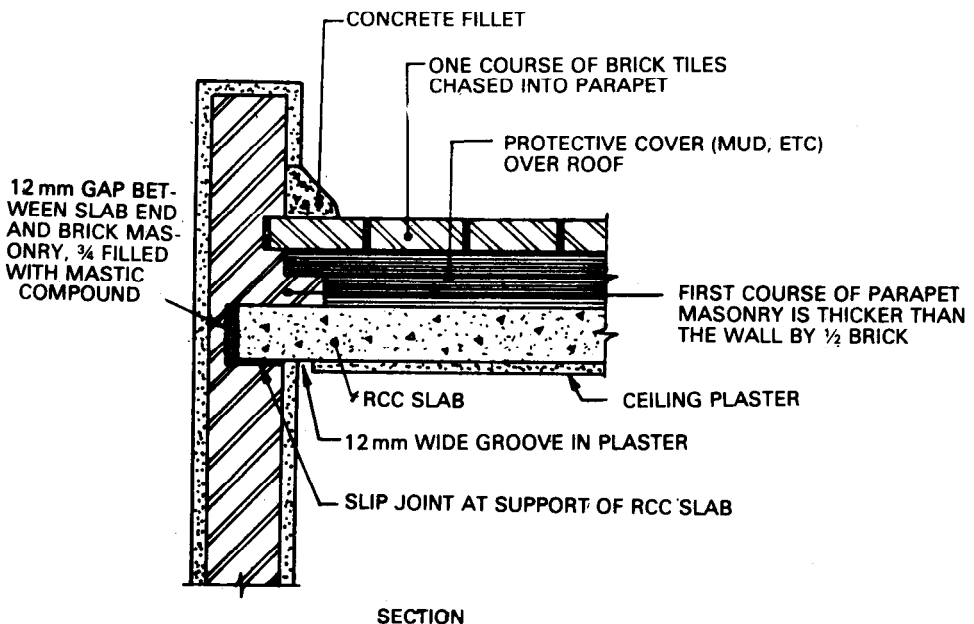

Fig. 12 Constructional Detail of Bearing of RCC Roof Slab Over A Masonry Wall

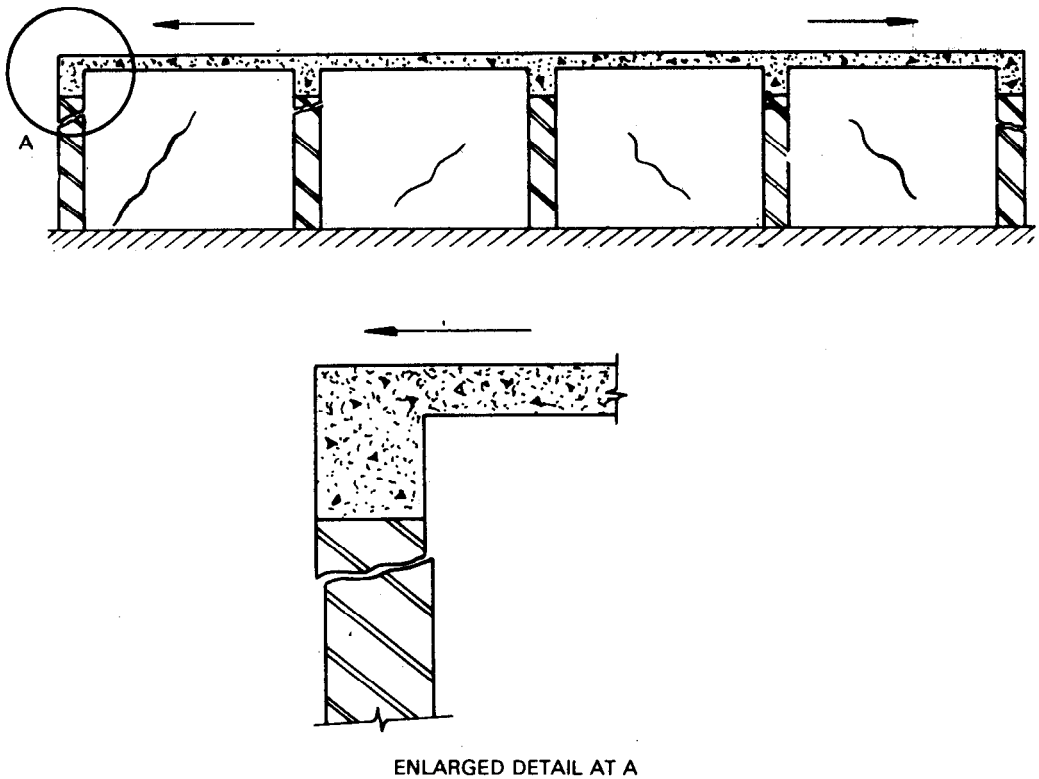

Fig. 13 Cracking in Cladding and Cross Walls of a Framed Structure

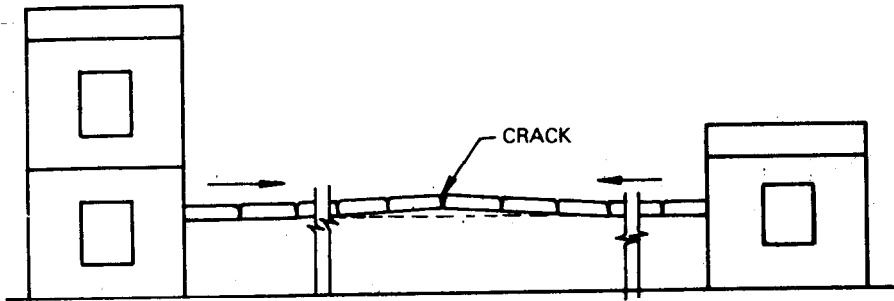

Fig. 14 Arching up and Cracking of Coping Stones of a Long Garden Wall

preventing the cracks in question, but severity of cracking could be much reduced and cracks made inconspicuous by adopting the following measures:

- 1) Concrete of slab should be of low shrinkage and low slump (see 2.3.3).
- 2) Construction of masonry over the slab should be deferred as much as possible (at least one month) so that concrete undergoes some drying shrinkage prior to the construction of parapet.
- 3) Mortar for parapet masonry should be 1 cement:1 lime : 6 sand and a good bond should be ensured between masonry and concrete.
- 4) Plastering on masonry and RCC work should be deferred as much as possible (at least one month) and made discontinuous at the junction by providing V-grooves in plaster. This way the cracks, if they occur, will get concealed behind the groove and will not be conspicuous.

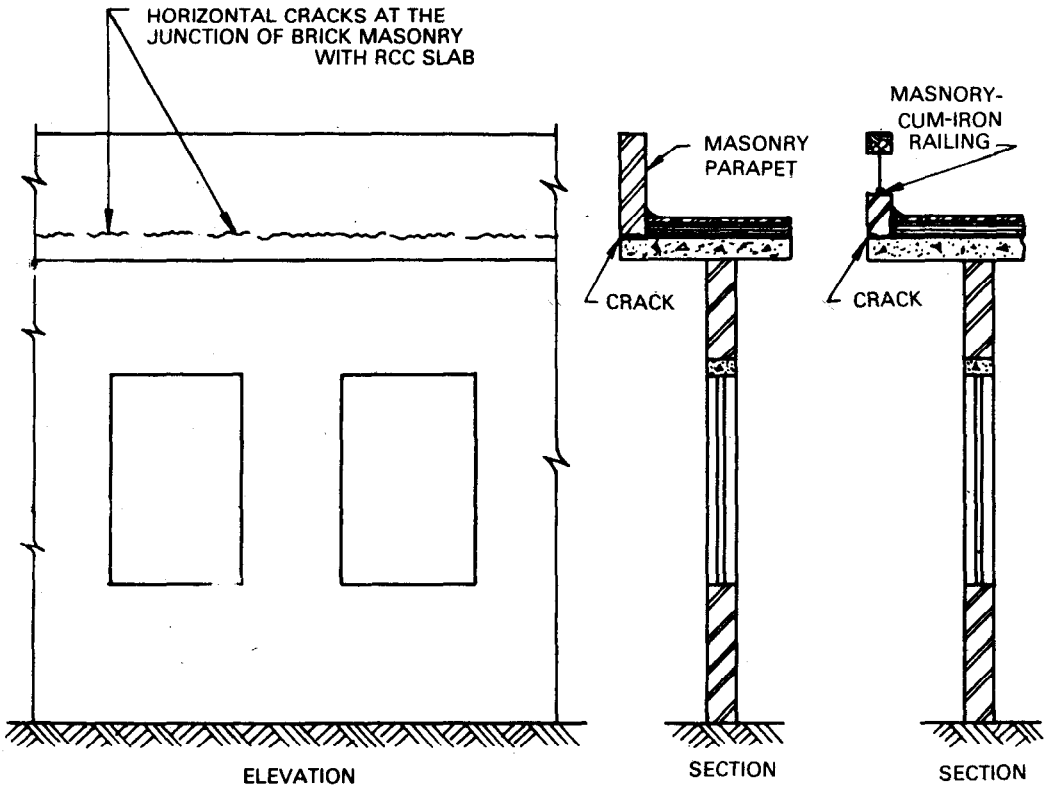

Fig. 15 Horizontal Crack at the Base of Brick Masonry Parapet (or Masonry-cum-Iron Railing) Supported on a Projecting RCC Slab

In case of brick-cum-iron railing, cracks could be avoided by substituting the brickwork (of which there are only a few courses) with a low RCC wall, supporting the iron railing.

- e) When 2 or more residential blocks of buildings, about 20 m or more in length are built in a row without any provision for thermal movement, vertical cracks occur either at the junction of blocks, when there is a joint in the RCC slabs at the junction or at some other weak section due to openings in walls or staircase wells, depending on length of blocks. To avoid these cracks, blocks of buildings longer than 20 m (in hot and dry regions) should be built with expansion joints at the junction of blocks with twin walls (see Fig. 16). In case of coastal areas and other regions, where temperature variations are less, spacing of joints could be more.

3.10 Some general measures for prevention of cracks due to thermal movement are given below:

- a) Wherever feasible, provision should be made in the design and construction of

structures for unrestrained movement of parts, by introducing movement joints of various types, namely, expansion joints, control joints and slip joints. This is an important measure for avoiding cracks and has been dealt with in greater detail subsequently in 3.11. In structures having rigid frames or shell roofs where provision of movement joints is not structurally feasible, thermal stresses have to be taken into account in the structural design itself, to enable the structure to withstand thermal stresses without developing any undesirable cracks.

- b) Even when joints for movement are provided in various parts of a structure, some amount of restraint to movement due to bond, friction and shear is unavoidable. Concrete, being strong in compression, can stand expansion but, being weak in tension, it tends to develop cracks due to contraction and shrinkage, unless it is provided with adequate reinforcement for this purpose. In case of one-way or cantilevered slabs, from structural consideration, reinforcement is required mainly in the direction of the span to take tension due to bending and no

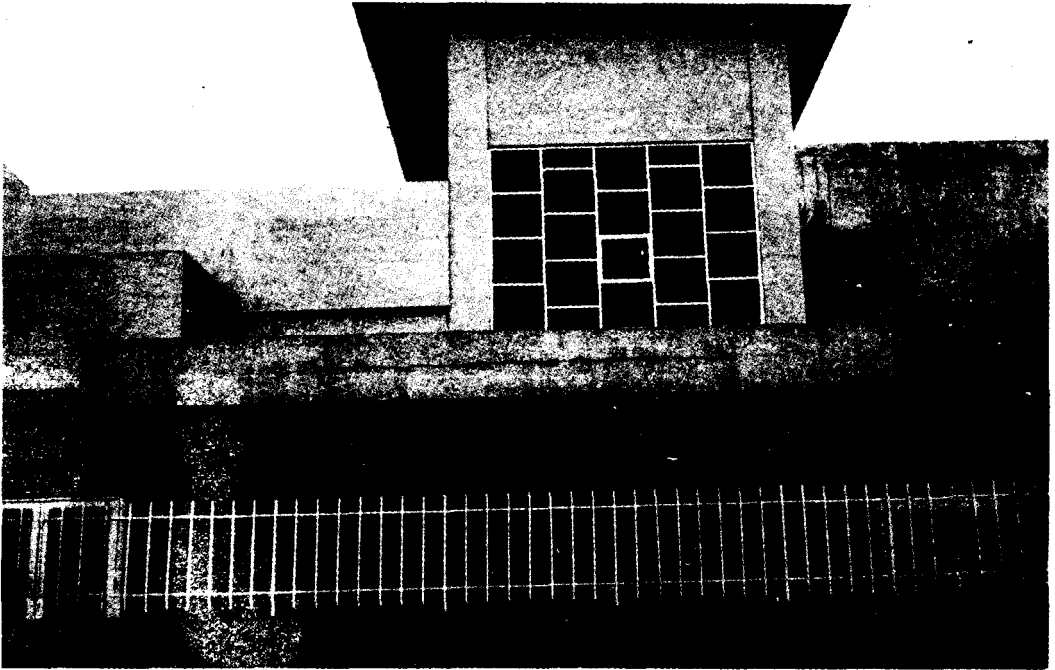

Photo 2 Horizontal Crack at the Junction of Brickwork and Concrete due to Differential Shrinkage and Thermal Movement



Photo 3 Horizontal Crack at the Support of a Brick-cum-Iron Railing Over an RCC Cantilevered Roof Slab due to Different Shrinkage and thermal Movement

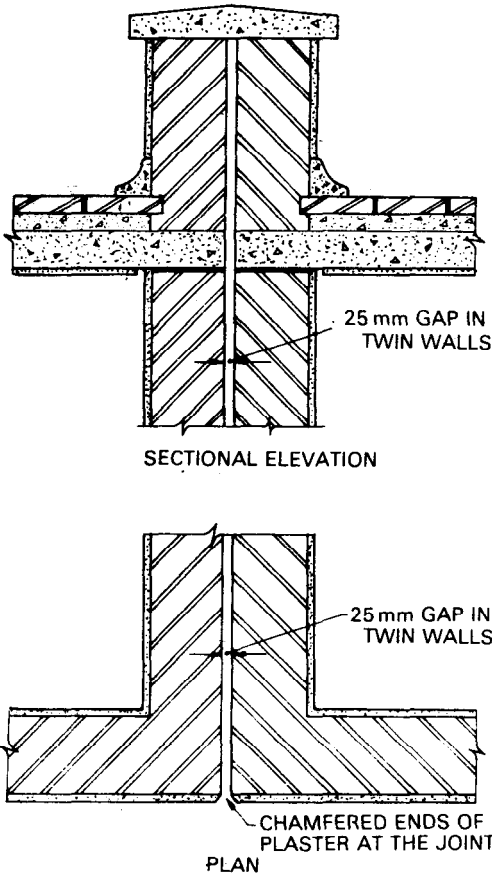

Fig. 16 Expansion Joints in Slabs Supported on Twin Walls

reinforcement is needed in the direction at right angle to the span. Members in question could thus develop cracks on account of contraction and shrinkage in the latter direction. It is, therefore, necessary to provide some reinforcement called 'temperature reinforcement' in that direction. Generally, minimum amount of this reinforcement should be 0.15 percent of the section area of the concrete when plain bars are used¹⁹. However, in case of members which are exposed to sun, for example sun-shades, fins, fascia, railings, canopies, balconies, etc., amount of 'temperature reinforcement' should be increased by 50 to 100 percent of the minimum amount, depending upon the severity of exposure, size of member and local conditions.

- c) Over flat roof slabs, a layer of some insulating material or some other material having good heat insulation capacity, preferably along with a high reflectivity finish, should be provided so as to reduce heat load on the roof slab, as discussed earlier in 3.5(c).

- d) In case of massive concrete structures, rise in temperature due to heat of hydration of cement should be controlled as explained earlier in 3.5(d).

3.11 Provision of Movement Joints in Structures

3.11.1 GENERAL — Movement joints in structures are introduced so that unduly high stresses are not set up in any part of a structure, and it may not develop unsightly cracks. When a joint permits expansion as well as contraction it is termed as 'expansion joint'; when it allows only contraction, it is termed as 'control joint' and when the joint permits sliding movement of one component over another it is termed as 'slip joint'.

3.11.2 EXPANSION JOINT — This consists of a pre-planned break in the continuity of a structure or a component of a structure with a gap 6 to 40 mm wide*, depending upon the extent of movement expected and constructional details. The gap in some cases is filled with a flexible material which gets compressed under expansive force and stretched under a pulling force. If there is a possibility of rain water penetrating through the joint, water bar or a sealant or a protective cover, or a suitable combination of these items is provided, depending upon the requirement in any particular situation. Width of expansion joint for jobs done in summer could be less than for those done in winter.

In load bearing structures if long walls are intercepted by cross walls at intervals, as is usually the case in common buildings like residences, hostels, hospitals, business premises, administration buildings, etc., the cross walls tend to confine the thermal movement to stretches of walls between the cross walls and thus the overall thermal movement gets reduced. In such a case, expansion joints could be somewhat farther apart. On the other hand, in case of warehouse type structures and factory buildings where, generally no or very few cross walls are provided, expansion joints have to be closer. In framed-structures, the structural members are in a position to bear to some extent, stresses due to thermal movement and thus expansion joints could be farther apart. For such components of a structure as are slender and exposed, for example, parapets and sun-shades, joints have to be at much closer intervals.

* For Seismic Zones, III, IV and V, joints have to be much wider for which IS:4326-1976 Code of practice for earthquake resistant design and construction of buildings (first revision) should be referred to.

Some typical designs of expansion joints for cases commonly occurring in buildings are shown in Fig. 16 to 21.

3.11.3 CONTROL JOINTS—Expansion of a structure results in a compressive force and

contraction or shrinkage in a tensile force. Since the principle materials used in buildings, namely, concrete and masonry are strong in compression and weak in tension, cracking mainly occurs due to contraction or shrinkage. That is the reason why in concrete

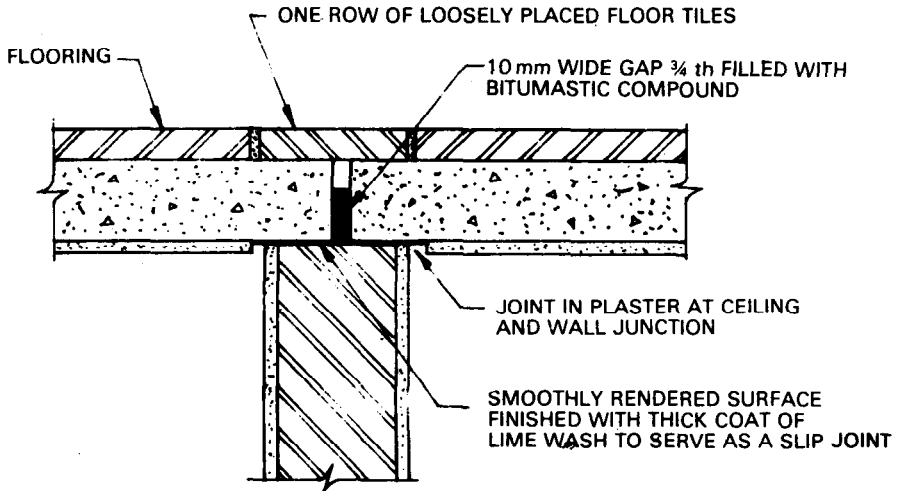

17A Joint in floor slab

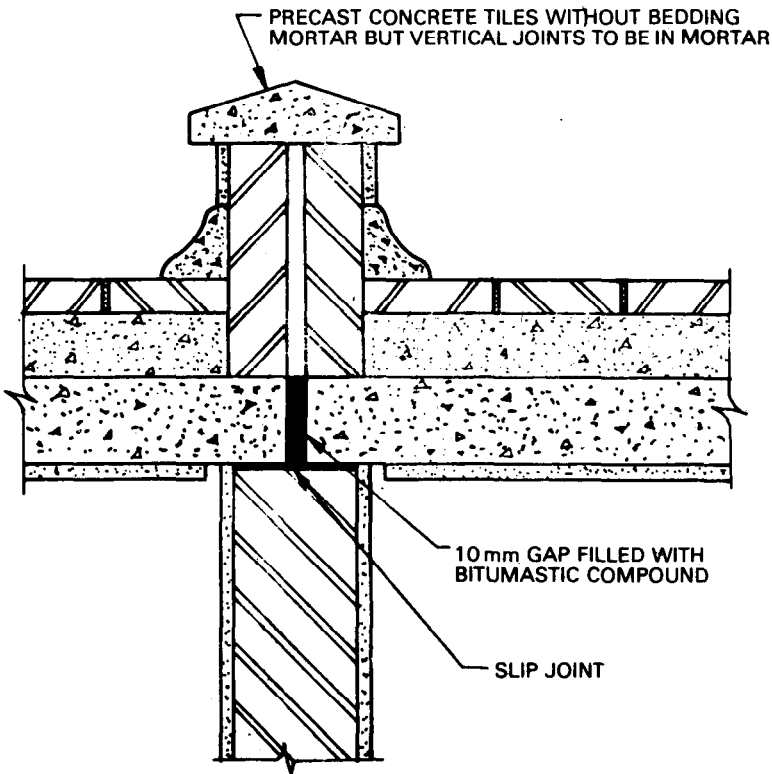

17B Joint in roof slab

Fig. 17 Expansion Joints in RCC Slabs Supported on Intermediate Walls

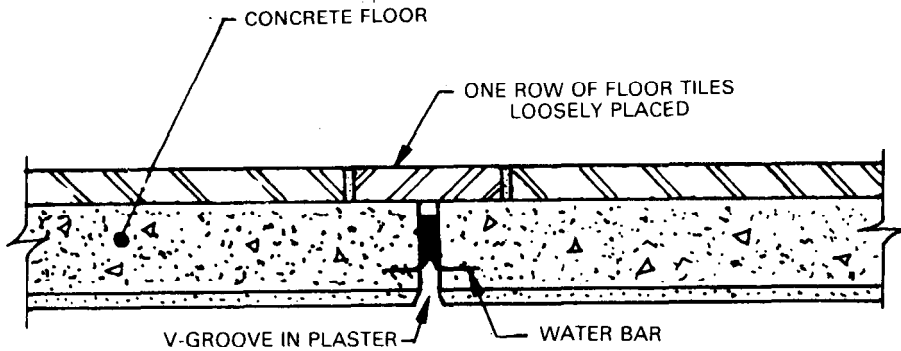

18A Joint in Floor Slab

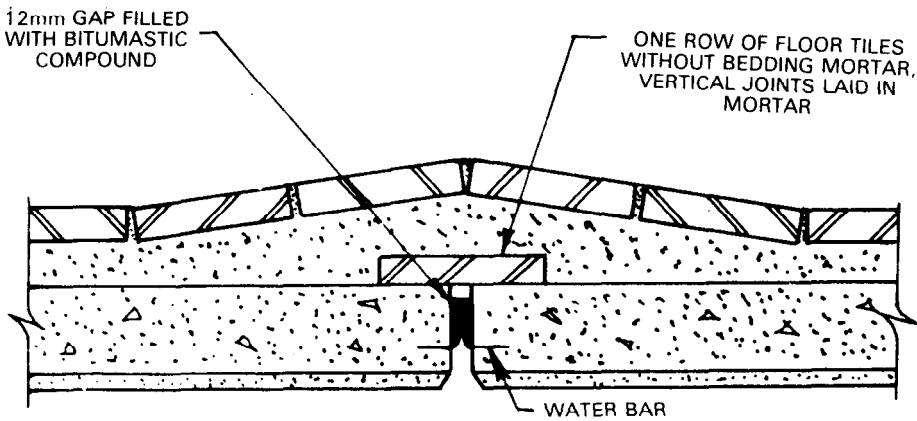

18B Joint in Roof Slab

Fig. 18 Expansion Joints in RCC Slabs of Long Open Verandahas Slabs Supported on Twin Walls

pavements, control joints are provided at closer intervals than the expansion joints.

A control joint consists of a straight butt joint without any bond at the interface. In case of floors and pavements, control joints are formed by laying concrete in alternate panels. Provision of strips of some materials which do not develop much bond with concrete, for example, glass, aluminium*, plastic, in a grid formation, is a convenient method of providing control joints in concrete floors to allow for shrinkage. A dummy joint (see Fig. 22) is another form of control joint and consists of a weak section at the joint (generally $2/3$ rd of the total thickness of the member) and is provided either by leaving a groove at the time of laying concrete or by mechanically forming a groove later after laying of concrete. When shrinkage takes

place, a straight crack develops at this dummy joint—being a weak section, and thus uncontrolled and haphazard cracking is obviated. Grooves of the dummy joint are generally filled with some mastic compound to conceal the crack and to prevent water getting into the joint.

In case of masonry walls with units having high shrinkage, for example, light-weight concrete units or sand-lime bricks, sometimes control joints are provided at weak sections (that is, at mid point of opening) by leaving the joints at a section dry, that is, unmortared, as shown in Fig. 23¹⁰. After shrinkage has taken place, unmortared joints could be filled up at the surface with weak mortar so that these do not look unsightly.

3.11.4 SLIP JOINT—A slip joint is intended to provide sliding movement of one component over another with minimum of restraint at the interface of the two components. A commonly occurring example is a joint between an RCC slab and top of

*Since aluminium reacts chemically with cement, thus causing stains in the floors, it is desirable to apply good quality paint to the aluminium strips, before placing the strips, in position.

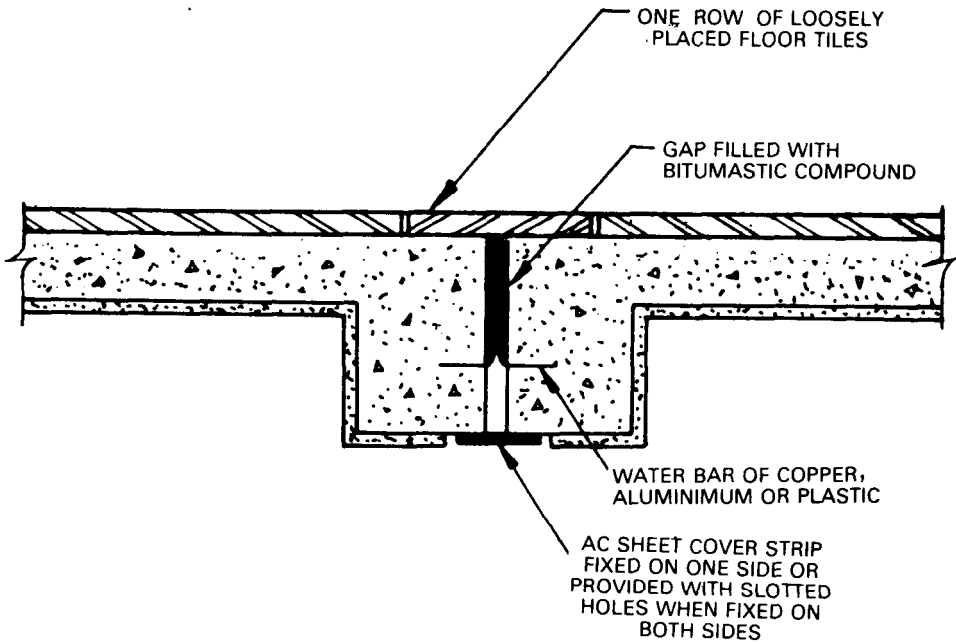

19A Joint in Floor Slab

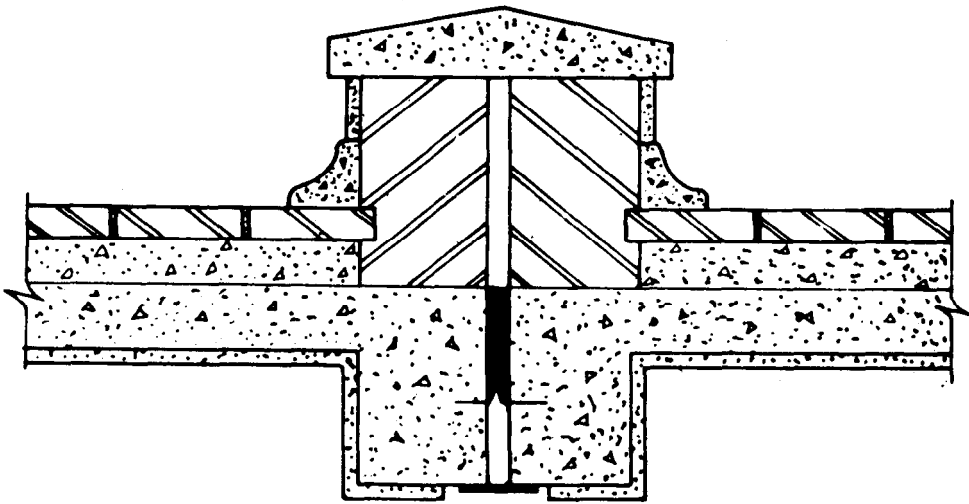

19B Joint in Roof with Normal Beam

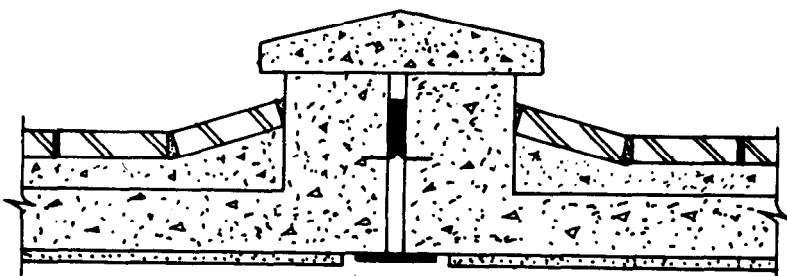

19C Joint in Roof with Inverted Beam

Fig. 19 Expansion Joints in RCC Slabs with Twin Beams—contd

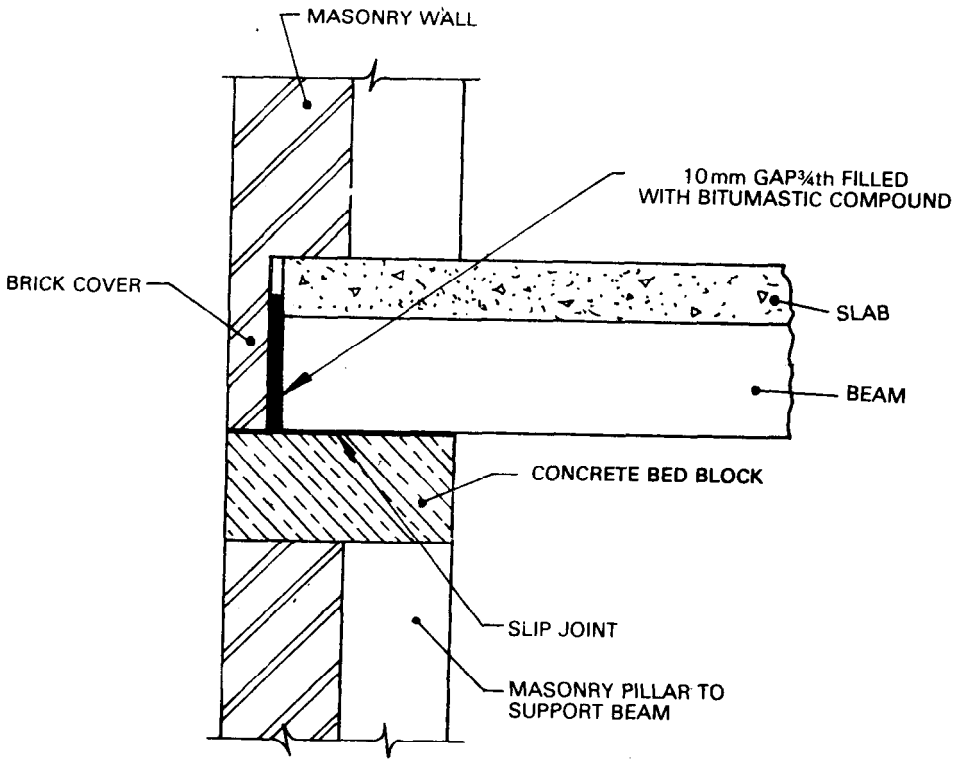

19D Details of supports for twin beams at expansion joint in load bearing structures

Fig. 19 Expansion Joints in RCC Slabs with Twin Beams

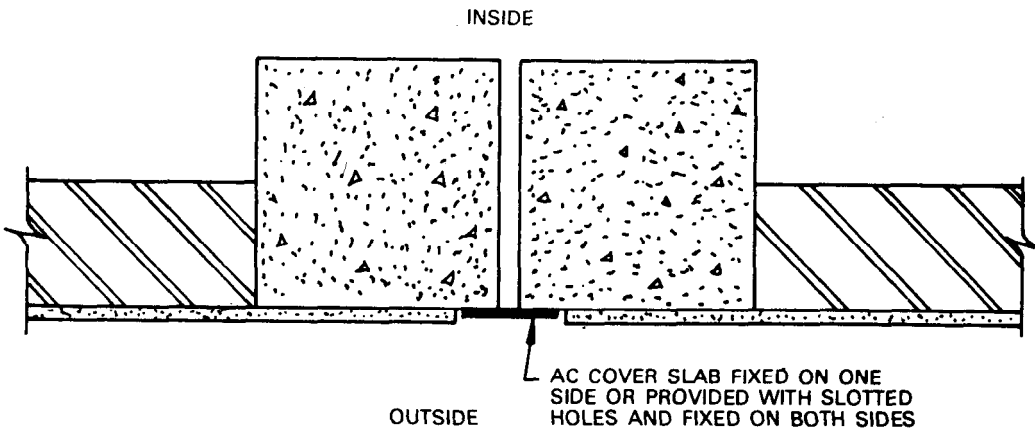

NOTE—Arrangements for expansion joints in floors and roofs of framed structure are similar to those for load bearing structure with twin beams as shown in Fig.19.

Fig. 20 Expansion Joints in Columns of Framed Structure

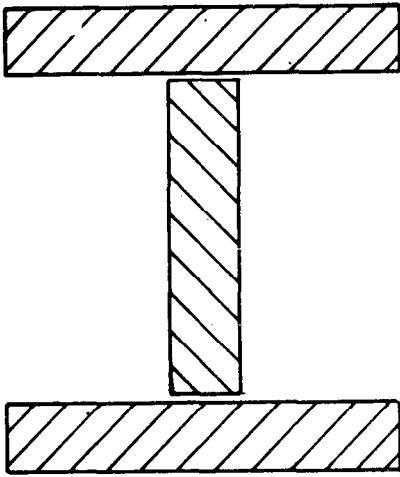

21A H-Shaped Building

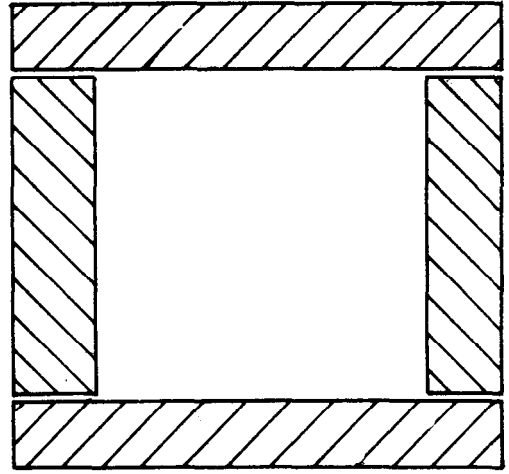

21B Rectangular Shaped Building

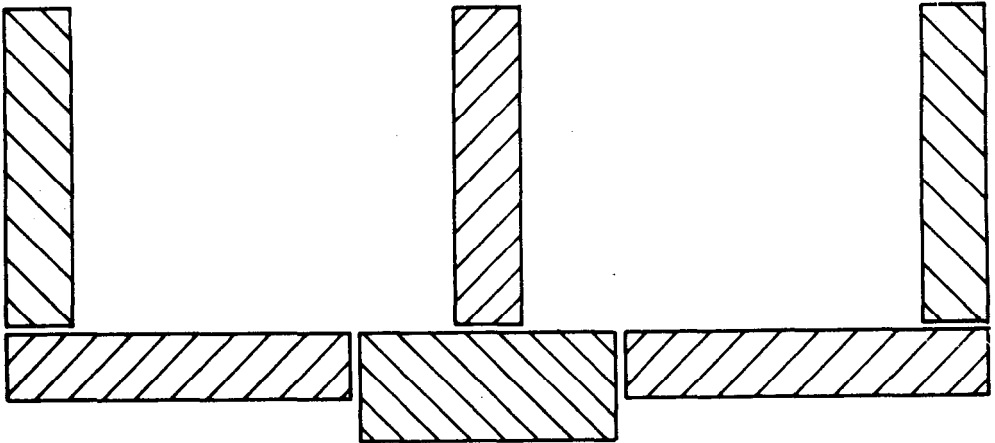

21C E-Shaped Building with Recesses in Front Elevation

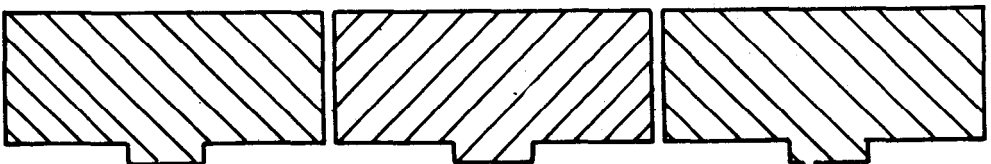

21D Blocks of Building in a Continuous Row with Twin Walls at Junction

Fig. 21 Locating Expansion Joints at Changes of Direction, in Recesses and at Junctions of Blocks

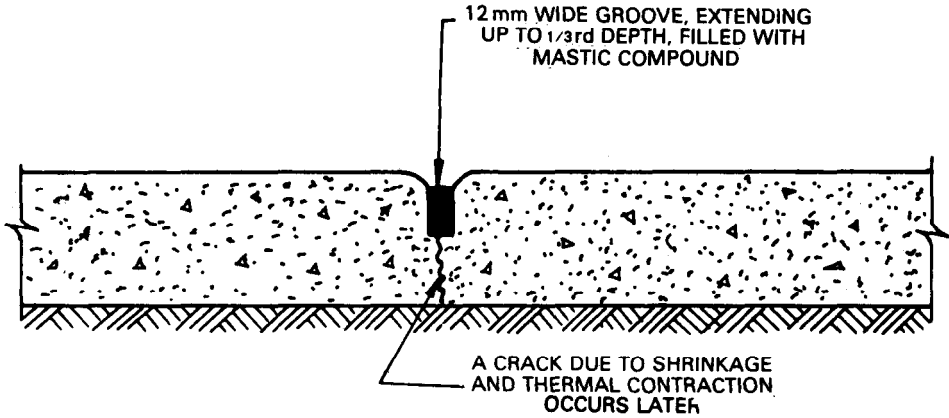

Fig. 22 Dummy Joint in a Concrete Pavement

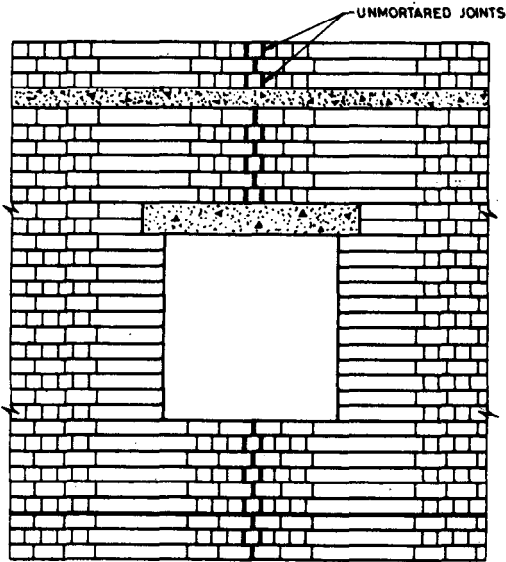

Fig. 23 Control Joint (Dry) in Masonry with Units Having High Co-efficient of Shrinkage

supporting wall (see Fig. 12). The bearing portion of the wall is rendered smooth with plaster, allowed to set and partly dry, and then given a thick coat of whitewash before casting the slab so that there is a minimum bond between the slab and the support. To ensure more efficient functioning of this joint, in place of whitewashing 2 or 3 layers of tarred paper are placed over the plastered surface to allow for easy sliding between RCC slab and the supporting masonry. When the slab expands due to rise in temperature, or contracts due to fall in temperature (also due to shrinkage of concrete) some movement can take place, thus obviating any excessive thrust or pull on the wall. Another example of a slip joint is the vertical butt joint (without mortar) between the wall of an existing building and that of an additional portion constructed subsequently. The joint enables the newly built portion of the building to settle and slide

down without causing any unsightly shear cracks at the junction of the new work with the old. A groove should be left in the wall plaster at the junction of old work with the new, and at the roof junction suitable measures should be adopted to prevent leakage of rain water through the joint in the roof.

3.11.5 Spacing and location of joints in a structure or its components is decided after taking into consideration properties of materials used in construction, temperature variations that are anticipated, temperature prevailing at the time of construction, that is, whether summer or winter, shape and size of a structure, degree of exposure of the structure or its components to heat and cold and experience gained in the behaviour of similar structures built in the past in a particular region (see Photo 4). Information given in Table 5 is intended to serve as a general guide in this regard. Since provision of joints in structures is helpful for prevention of cracks, not only due to thermal effects, but also due to some other causes, namely, moisture movement, creep and elastic deformation, information given in Table 5 covers joints required for various purpose.

SECTION 4 ELASTIC DEFORMATION

4.1 Structural components of a building such as walls, columns, beams and slabs, generally consisting of materials like masonry, concrete, steel, etc, undergo elastic deformation due to load in accordance with Hook's law, the amount of deformation depending upon elastic modulus of the material, magnitude of loading and dimensions of the components. This deformation, under circumstances such as those mentioned below, causes cracking in some portions:

- a) When walls are unevenly loaded with wide variations in stress in different parts,

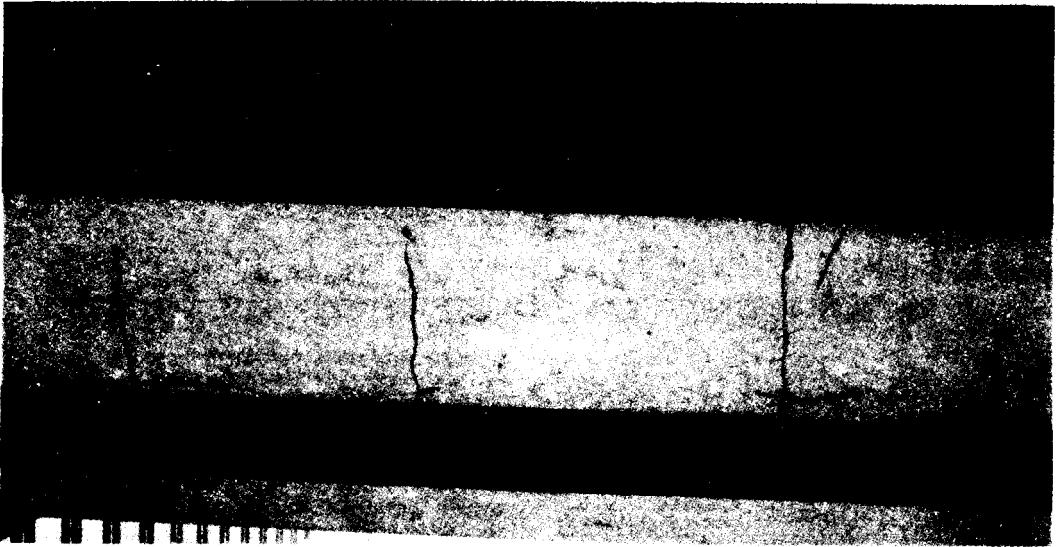

Photo 4 Vertical Cracks in RCC Railing Due to Drying Shrinkage of Concrete and Thermal Movement

TABLE 5 A GENERAL GUIDE FOR PROVISION OF MOVEMENT JOINTS IN BUILDINGS

Sl. No. (1)	PARTICULARS (2)	MOVEMENT JOINT AND OTHER MEASURES (3)
i) <i>Load bearing structures:</i>		
a) Buildings with flat roof having cross walls at intervals as in residences, hostels, hospitals, office buildings, business premises, schools, etc. (see Photo 5)		Provide vertical expansion joints 20 to 40 mm wide, 25 to 40 m apart. For this purpose, introduce twin walls or a wall and a beam or twin beams at the expansion joint. Joints should start from DPC level and should be through walls as well as floors, roof and parapet. In RCC roof slab, provide additional expansion joints such that length of a slab does not exceed 15 to 20 m ¹¹ . It is necessary to locate some expansion joints at change of direction and at sections of substantial change in height of a building, concealing the joints in recesses, where feasible. When blocks of buildings, such as residential flats are built in continuous rows, expansion joints should be provided at junctions of blocks as shown in Fig. 21 D.
b) Buildings of warehouse type or factory buildings with flat roof having no or very few cross walls		Provide vertical expansion joints, 20 to 40 mm wide at 20 to 30 m intervals with twin beams at the joints. In case pillars or columns are provided in a building to support the beams, it will be necessary to provide twin pillars/columns at the joints. If walls are panel walls between columns which support roof beams, vertical expansion joints should be provided 25 to 40m apart, as in (i) (a) above.
c) Buildings of warehouse type or factory buildings having sloping roof with sheets or tiles on trusses		For expansion of walls in the longitudinal direction, expansion joints should be provided as in (i) (b), with either twin trusses at the joints or single truss on one side of the joint and slotted holes in purlines resting over the truss, to allow for movement in the longitudinal direction. No joints are required in roofing sheets and other purlins since slight play in bolt-holes is enough to take care of thermal movements in these items. For steel trusses with rivetted joints, no provision for movement of trusses in the transverse direction for spans up to 15 m is necessary as slight play in rivetted joints allows for necessary movements. For spans between 15 and 25 m in case of rivetted trusses and spans up to 25 m in case of welded trusses, one end of the truss should be fixed and the other end should have slotted holes with a slip joint at the support to allow for transverse movement. Trusses exceeding 25 m in length should have roller and rooker bearing arrangement.
d) RCC roof slab having adequate thermal insulation on top		In hot and dry regions like North India, where variations in temperature are more than 15°C, provide expansion

(Continued)

TABLE 5 A GENERAL GUIDE FOR PROVISION OF MOVEMENT JOINTS IN BUILDINGS

Sl. No. (1)	PARTICULARS (2)	MOVEMENT JOINT AND OTHER MEASURES (3)
		joints in slabs 20 to 25 mm wide and 15 to 20 m apart. Where variations in temperature are less than 15°C, additional joints apart from those of (i) (a) are not needed.
e)	RCC roof slab having no or very little thermal insulation or protective cover on top	Provide expansion joints in slab 10 to 15 m apart.
f)	Supports for RCC slabs exceeding 4 to 6 m length	Provide slip joint between the slab and the bearing wall, keeping a gap of about 12 mm width between slab and brick cover [see Fig. 12 and 13.9(a)]
ii)	RCC-framed structures:	
a)	RCC-framed structure	Provide vertical expansion joints 25 to 40 mm wide, at 30 to 45 m interval. Joints should be provided by introducing twin columns and twin beams, twin columns having combined footing. It is necessary to locate some expansion joints at change of direction and at sections of substantial change in height of a building concealing the joints in recesses, where feasible (see Fig. 21). Roof slab should have adequate thermal insulation on top.
b)	Panel walls for cladding	Provide a horizontal expansion joint about 10 mm in width between the top of panel and soffit of beam. This gap may be filled up with mastic compound finished with some sealant or filled with weak mortar up to a depth of 3 cm on the external face and left open on the internal face. If structurally necessary, lateral restraint to the panel at the top should be provided by using telescopic anchorages (see Fig. 24). In case of panels longer than 5 to 8 m, either provide a groove in the plaster at the junction of RCC column and brick panel, or fix a 10 cm wide strip of metal mesh or lathing over the junction before plastering. The reinforced strip of plaster can accommodate differential movement elastically, without cracking, to some extent.
c)	Masonry partitions	Provide horizontal expansion joints as in (ii) (b).
iii)	Junction between old and new structures	Provide vertical slip joints or expansion joints, depending upon the length of the old new portions; make suitable arrangement for preventing seepage of rain water into the joint from top and sides.
iv)	Long compound walls of masonry	Provide vertical expansion joints 5 to 8 mm wide at 5 to 8 m interval from grade level upwards; also provide expansion joints at changes of direction; provide additional control joints in coping stones mid-way.
v)	Concrete pavements	Provide expansion joints 20 to 25 mm wide at 25 to 40 m interval together with control joints at 5 to 8 m interval, depending on thickness of pavement, extent of temperature variation anticipated, and local conditions. Thinner the pavement, closer the spacing of control and expansion joints. Joints are needed both in longitudinal and transverse direction. In the transverse direction, a spacing of 3 to 5 m for control joints is generally adopted, depending upon the size of construction equipment available; control joints normally function as construction joints as well. As far as possible, panels should be squarish in shape-length to breadth ratio should not exceed 1.5 m. Incidence of shrinkage cracking in panels which are rectangular in shape is comparatively more than that of square panels.
vi) a)	RCC sun-shades	Provide expansion joints 5 to 8 mm wide and 4 to 6 m apart; joints should be only in the exposed portion, that is, projected portion; some joints should invariably be located at change of direction; reinforcement should not be continued through the joint. It is not necessary to fill the joint with any jointing material.
b)	RCC facia	Provide expansion joints as in (vi) (a).

(Continued)

TABLE 5 A GENERAL GUIDE FOR PROVISION OF MOVEMENT JOINTS IN BUILDINGS—CONTD.

Sl. No. (1)	PARTICULARS (2)	MOVEMENT JOINT AND OTHER MEASURES (3)
c)	RCC balcony	Provide vertical expansion joints 8 to 12 mm wide and 6 to 9 m apart, with water bar, filled with mastic compound.
d)	RCC railing	Provide expansion joint 5 to 8 mm wide, 6 to 9 m apart.
e)	Open verandah with RCC slab floors/roof	Provide vertical expansion joints in slabs (parallel to the span) 10 to 15 mm wide and 6 to 9 m apart; joints should be located at the centre of supporting pillars; joints may be filled with mastic compound and V-grooved at the bottom and suitable arrangement made at the top to prevent leakage of water through the joint. (see Fig. 17)
f)	Brick tiling over mud phuska for roof terracing	Brick tiles should be laid with joints 8 to 10 mm wide, grouted with mortar, 1 cement : 1 lime : 6 sand; no expansion joints are required.
g)	Lime concrete terrace over roof slab	Provide, 10 to 15 mm wide dummy joints, 4 to 6 m apart; fill the joints with some mastic compound.
h)	Pre-cast concrete slabs over lime concrete terracing	Size of slabs should be 0.6 to 0.75 m square and these should be laid in lime mortar with 10 mm wide expansion joints, 4 to 6 m apart in both directions; joints should be filled with some mastic compound.
j)	Concrete/terrazo flooring	Provide control joints 1 to 2 m apart; alternatively, provide strips of glass, aluminium or some plastic material at 0.75 to 1.20 m interval in both directions; joints or strips are required mainly to prevent shrinkage cracks. When laying floor over an RCC structural slabs, ensure good bond with RCC slab by thorough cleaning of slab surface (roughening it by hacking if necessary) and priming with cement slurry. Alternately, provide a lime concrete base course 5 to 7.5 cm thick over the structural slab.
k)	Plaster work	<p>Joints in brick masonry should be raked to 10 mm depth while mortar is green. Plastering should be done after masonry has been cured and dried.</p> <p>At the junction of wall and ceiling provide a groove in plaster about 10 mm in width as shown in Fig. 12. When plastering over long masonry walls, abutting RCC columns, either give a vertical groove in plaster at the junction or embed in the plaster over the junction a 10 cm wide strip of metal mesh or lathing as in item (ii) (b).</p> <p>Sometimes longitudinal cracks occur in the plaster along conduits/pipes embedded in chases in masonry. To avoid these cracks, conduits/pipes should be placed at least 15 mm below the wall surface and embedded up to wall surface in concrete 1:2:3, cement : sand : coarse aggregate, using well graded coarse sand and 6 mm and down graded coarse aggregate. Concrete surface should be finished rough and plastered over after 7 days or more at the time of general plastering of the wall.</p>

NOTE — For seismic Zones III, IV & V, expansion joints have to be much wider for which IS: 4326-1976 'Code of practice for earthquake resistant design and construction of buildings (first revision)' should be referred.

- excessive shear strain is developed which causes cracking in walls;
- b) When a beam or slab of large span undergoes excessive deflection and there is not much vertical load above the supports, ends of beam/slab curl up causing cracks in supporting masonry; and
- c) When two materials, having widely different elastic properties, are built side by side, under the effect of load, shear stress is set up at the interface of the two materials, resulting in cracks at the junction.

This type of cracking has been explained below with the help of a few typical cases of common occurrence.

4.2 Figure 25 shows a multi-storeyed load bearing structure having brick walls and RCC floors and roof.

When the central wall 'A' which carries greater load than external walls 'B' has either the same thickness as walls 'B' or is not correctly proportioned, it is stressed more than the walls 'B'. This results in shear stress in the cross walls which are bonded to the load

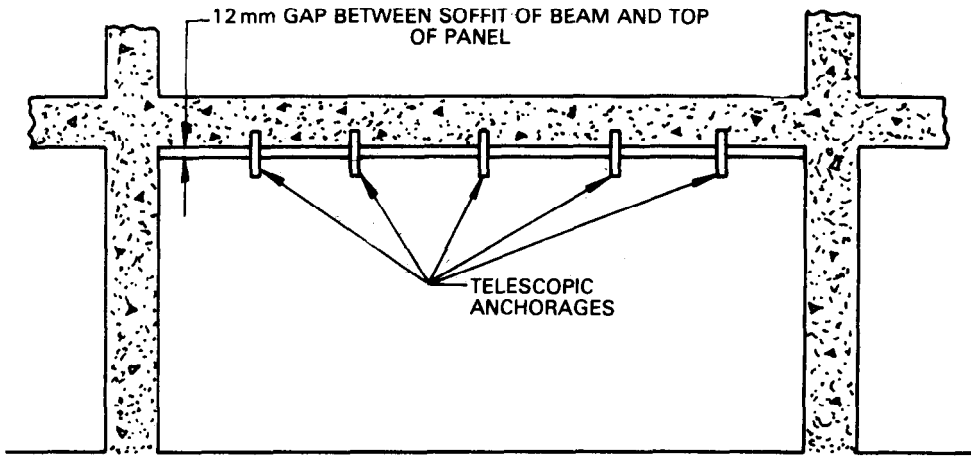

24A Elevation

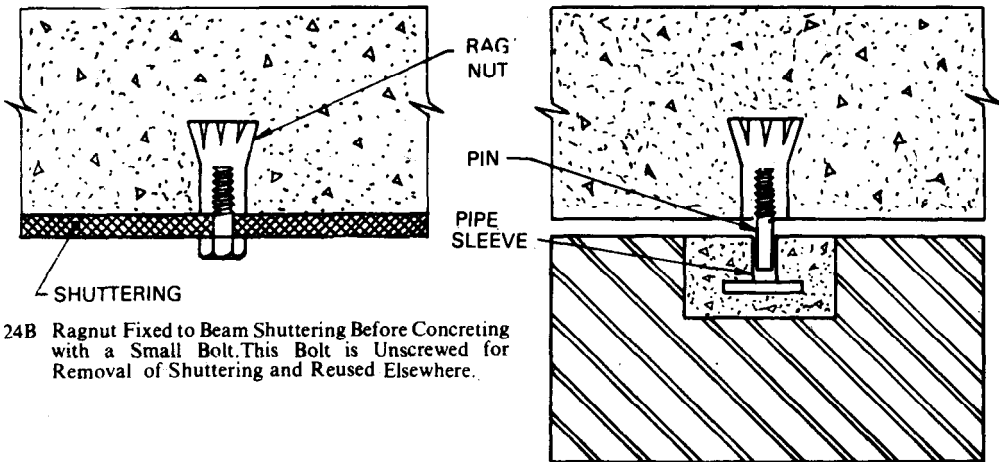

24B Ragnut Fixed to Beam Shuttering Before Concreting with a Small Bolt. This Bolt is Unscrewed for Removal of Shuttering and Reused Elsewhere.

24C Threaded Pin Screwed into Ragnut on Top and Held in a Pipe Sleeve Concreted in Masonry Panel. The Pin Allows Movement Between Beam and Panel Wall in the Vertical Direction but Prevents Horizontal Movement of the Panel.

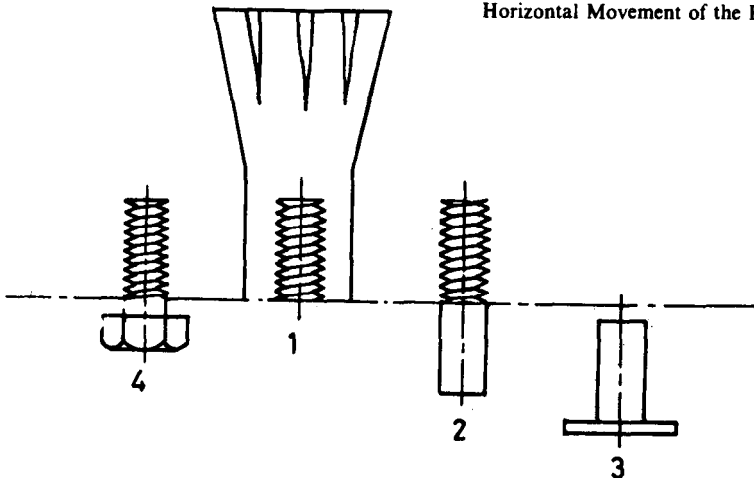

24D Enlarged View of (1) Ragnut, (2) Threaded Pin, (3) Pipe Sleeve and (4) Temporary Nut

Fig. 24 Schematic Sketch of Telescopic Anchorage for Panel Walls

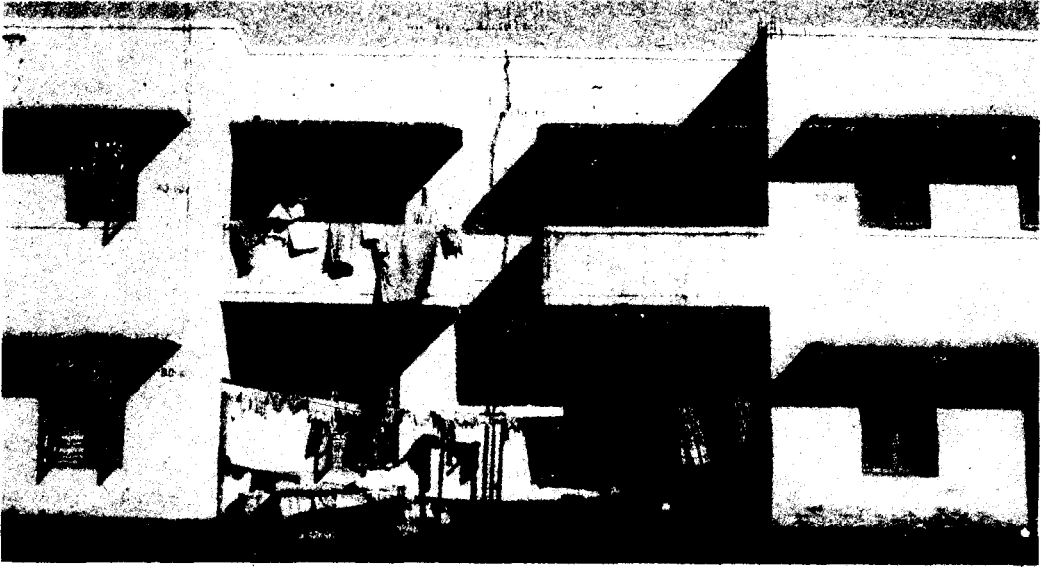

Photo 5 Vertical Crack at the Junction of Two Blocks of Residential Flats, Each Block Being About 20m in Length

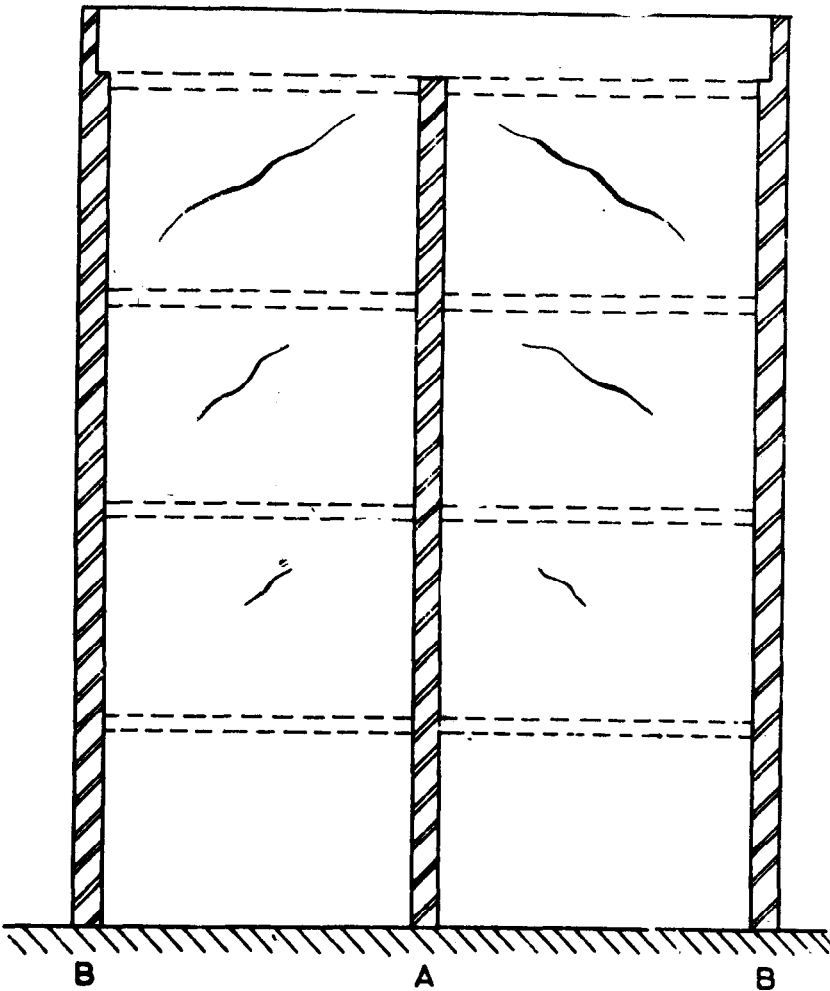

Fig. 25 Diagonal Cracks in Cross Walls of Multi-Storied Load Bearing Structures

bearing walls 'A' and 'B' and causes diagonal cracking as shown in Fig. 25. It is thus necessary to design carefully to ensure that stress in various walls of a load bearing structure is more or less uniform.

4.3 Figure 26 shows in elevation another load bearing multi-storeyed structure having large window openings in the external walls.

It can be seen that portions of wall marked 'A' act as pillars and are stressed much more than the portions marked 'B' below the windows. Thus, as a result of differential stress, vertical shear cracks occur in the wall as shown (see also Photo 6). To minimize these cracks, too much disparity in stress in different walls or parts of a wall should be avoided. If RCC slabs, RCC lintels over openings and masonry in plinth and foundation have good shear resistance, cracking in question would not be very significant.

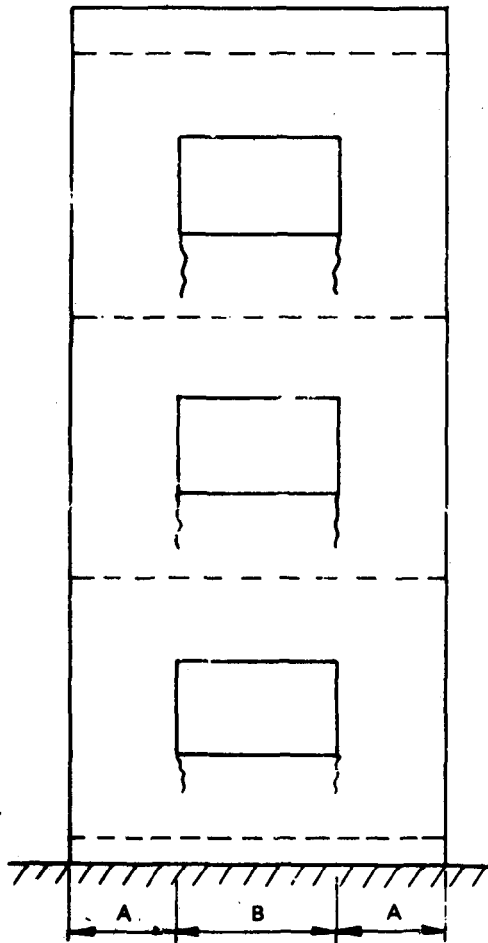

Fig. 26 Vertical Cracks in Multi-Storeyed Buildings Having Window Openings in Load Bearing Wall

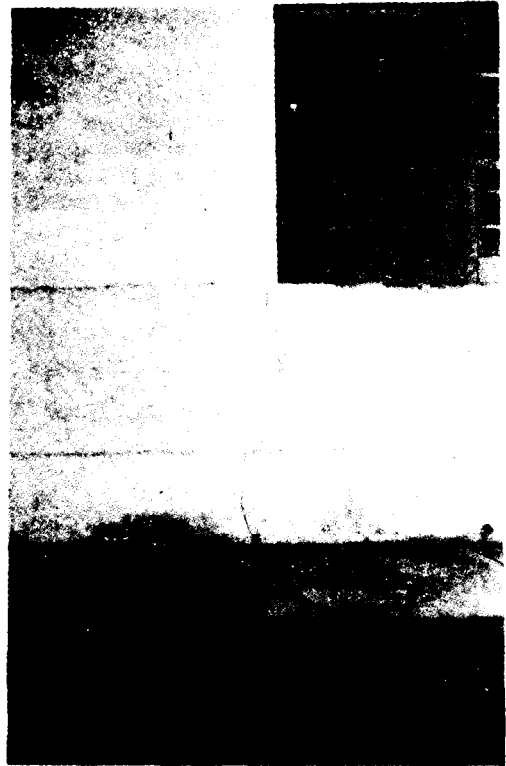

Photo 6 Vertical Crack at Window Sill Level Due to Differential Strain in the Loaded and Unloaded Portions of a Load Bearing Wall

4.4 Figure 27 shows cracks at supports due to bending deflection of a slab of large span. Such cracks occur mostly in the upper one or two storeys where vertical load on the wall is comparatively small. When large spans cannot be avoided, deflection of slabs or beams could be reduced by increasing depth of slabs and beams so as to increase their stiffness. Adoption of bearing arrangement as in Fig. 12 and provision of a groove in plaster at the junction of wall and ceiling will be of some help in mitigating the cracks.

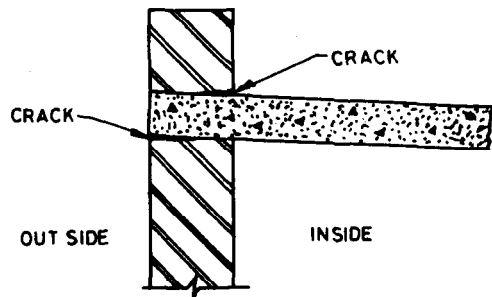
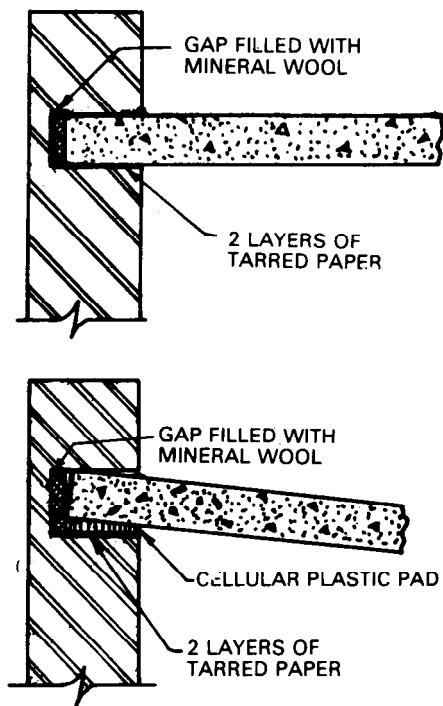

Fig. 27 Horizontal Cracks in a Wall at Supports Due to Excessive Deflection of a Slab of Large Span

Sahlin²⁶ has recommended use of cellular plastic pad with a layer of tar-felt under the slab bearing together with a filling of mineral wool between the slab and brick cover in the upper-most one or two storeys of a multistoreyed building having large spans so as to avoid cracks at supports due to deflection and shrinkage of slab as shown in Fig. 28.



(Reproduced from 'Structural Masonry' by S. Sahlin²⁶)

Fig. 28 Details of Bearing at the Support for a Roof Slab of Large Span

4.5 If glazed, terrazo or marble tiles are fixed to a masonry wall too soon, that is before wall has undergone normal strain due to elastic deformation, drying shrinkage and creep, excessive shear stress is likely to develop at the interface of masonry and tiles, resulting in dislodging or cracking of tiles. It is thus necessary to allow adequate time lag between work of wall masonry and fixing of tiles.

4.6 It is essential that centering for *in-situ* RCC slabs and beams which are to support masonry walls over them is struck prior to laying of masonry and some time is allowed to lapse so that deflection of beam/slab, due to its self load, takes place before start of masonry work as otherwise masonry may crack due to deflection of slab/beam. This has been discussed further in 5.9.

SECTION 5 MOVEMENT DUE TO CREEP

5.1 Some building items, such as concrete, brickwork and timber, when subjected to sustained loads not only undergo instantaneous elastic deformation, but also exhibit a gradual and slow time-dependent deformation known as creep or plastic strain. The latter is made up of delayed elastic strain which recovers when load is removed, and viscous strain which appears as permanent set and remains after removal of load. This phenomenon known as creep is explained in Fig. 29.

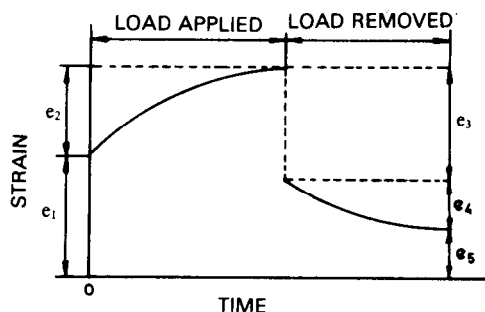

- e_1 —Elastic strain which is instantaneous
- e_2 —Creep or plastic strain which is time dependent
- e_3 —Instantaneous recovery which for practical purposes is taken as equal to e_1
- e_4 —Delayed elastic recovery which is time dependent
- e_5 —Permanent viscous strain which remains after removal of load.

Fig. 29 Phenomenon of Creep for a Visco-Elastic Material

5.2 Mechanism of creep is not yet clearly understood. At low stress it is thought to be due to seepage and viscous flow and at high stress it may be due to inter-crystalline slip and micro-cracking. In concrete, extent of creep depends on a number of factors, such as water and cement content, water cement ratio, temperature, humidity, use of admixtures and pozzolanas, age of concrete at the time of loading, and size and shape of the component. Creep increases with increase in water and cement content, water cement ratio, and temperature; it decreases with increase in humidity of the surrounding atmosphere and age of material at the time of loading. Use of admixtures and pozzolanas in concrete increases creep. A high surface to volume ratio of concrete also increases creep because moisture in concrete can seep out at a faster rate without encountering much impedece. Thus, under similar circumstances, a small and thin component of concrete will undergo larger creep than a large and massive component.

In case of brickwork, amount of creep depends on stress/strength ratio and, therefore, creep in brickwork with weak mortar, which generally has higher stress/strength ratio, is more. Another reason for greater creep in case of brickwork with weak mortar is that weak mortar has greater viscous flow than a strong mortar. Thus for the same quality of bricks, creep of brickwork in 1:1:6 mortar is 2 to 3 times that of brickwork in 1:4:3 mortar.

Ratio of total strain to instantaneous strain of concrete varies between 2 to 4 as compared to a range of 1.2 to 2.2 for brickwork. As an approximation, creep in brickwork is taken as 20 to 25 percent of that in concrete.

5.3 When stress in a material is less than two-third of the ultimate strength of the material, creep ceases after some time, total amount of creep depending upon the magnitude of stress. In brickwork, creep may cease after 4 months while in concrete it may continue up to about a year or so. However, in concrete, extent of creep is related to the process of hardening and thus most of the creep takes place in the first month and after that its pace slows down.

That means creep strain can be reduced by deferring removal of centering and application of external load. It is thus a common practice to adopt this method in case of cantilevered RCC members, namely, canopies, balconies, etc, to reduce overall deflection — that is in cases where deflection is otherwise quite large.

5.4 In steel under tension, there is no creep up to yield point, but beyond the yield point up to point of failure, creep is quite substantial. Amount of creep in steel increases with rise in temperature.

5.5 An important consequence of creep in concrete is the substantial increase in deformation of structural members, which may be 2 to 3 times the initial elastic deformation¹⁷. This deformation sometimes results in formation of cracks in brick masonry of framed and load bearing structures. Where deformation due to elastic strain and creep occurs in conjunction with shortening of an RCC member due to shrinkage, cracking is much more severe and damaging (see Photo 7). A few cases of



Photo 7 Horizontal Crack in Masonry Supported on a Cantilevered Canopy Slab due to Elastic Deformation, Shrinkage and Crack in RCC Canopy Slab

cracking due to combined effect of elastic strain, creep and shrinkage have been discussed below. Measures to be adopted for avoidance of cracks in such cases have been given in 5.10.

5.6 In certain situations, creep has a beneficial effect on the performance of materials, as it tends to relieve shrinkage and thermal stresses. For example, seasonal variations in temperature being gradual and slow, have less damaging effect on a structure because of creep in the material. Similarly, if process of curing of concrete and masonry is discontinued gradually, thereby slowing down the pace of drying of these items, shrinkage stress gets relieved due to creep, and cracking due to shrinkage is lessened.

5.7 Vertical Cracks at the Junction of Brick Masonry with an RCC Column in a Load Bearing Structure

Figure 30 shows a load bearing structure having mostly brick walls for supporting loads but in some portions, such as staircase wall where loading is heavy, RCC columns are provided to support the stair load. Brick walls normally in such jobs are built simultaneously with RCC columns. In course of time, RCC columns undergo some shortening due to elastic deformation, creep and shrinkage and because of difference in the strains in RCC columns and masonry, vertical shear cracks appear at junction of the two materials.

When an additional storey is added to an existing building, there is likelihood of cracks

occurring at the junction of masonry and RCC columns in the old portion of the building. It is difficult to avoid these cracks. Renewal of finish on walls of old portion should be carried out 2 or 3 months after imposition of additional load due to new construction (even later than this where feasible) so that cracks may get concealed in the finish.

5.8 Cracking in Brick Panel Walls of a Framed Structure

a) Horizontal cracks—Figure 31 shows brick panel wall of a framed structure supported on a beam and built right up to the soffit of the upper beam.

Due to shortening of column, caused by elastic deformation, creep and drying shrinkage, or due to comparatively greater deflection of upper beam under heavy loads, wall is subjected to a large compressive force, with the result that it gets buckled, and horizontal flexural cracks occur as shown in Fig. 31.

b) Vertical Cracks—In case of long panels built tightly between RCC columns, brickwork may due to thermal and moisture expansion get compressed and buckled and thus develop vertical crack as shown in Fig. 32. A linear movement of only 0.25 mm in 6 m length can produce a bulge of 25 mm⁶.

5.9 Cracking of Masonry Partitions in Load Bearing and Framed Structures due to Excessive Deflections of Support—Location and pattern of cracks in this example depend

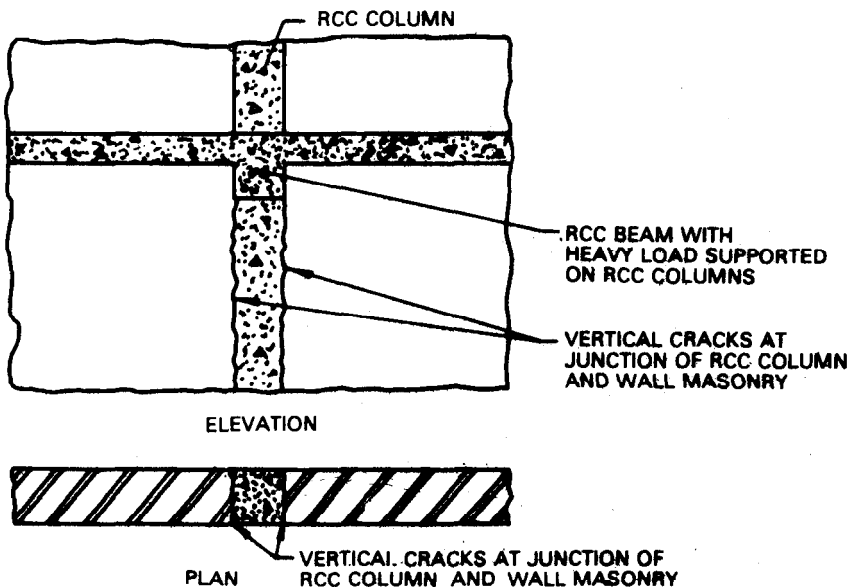

Fig. 30 Vertical Cracks at Junction of RCC Column and Wall Masonry in a Load Bearing Structure

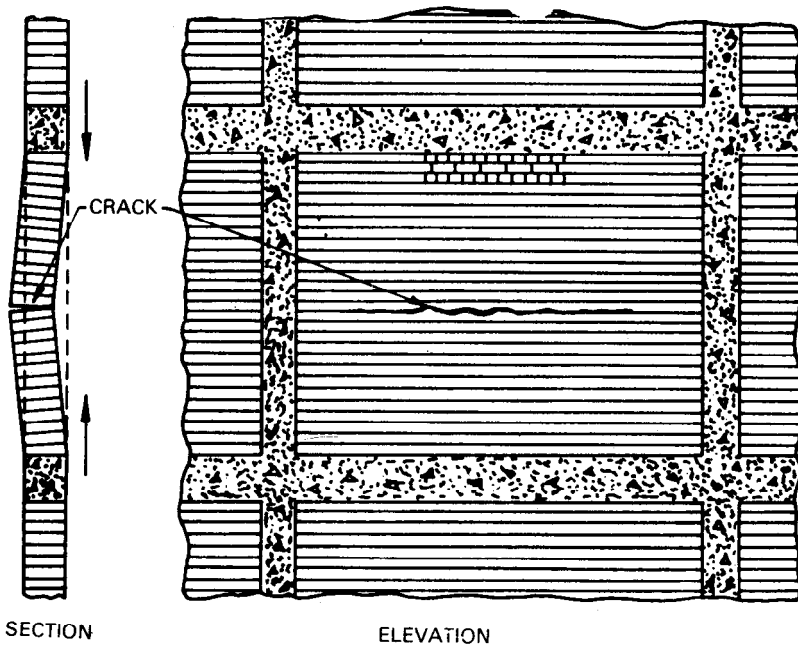

Fig. 31 Horizontal Cracks in Brick Panels of a Framed Structure

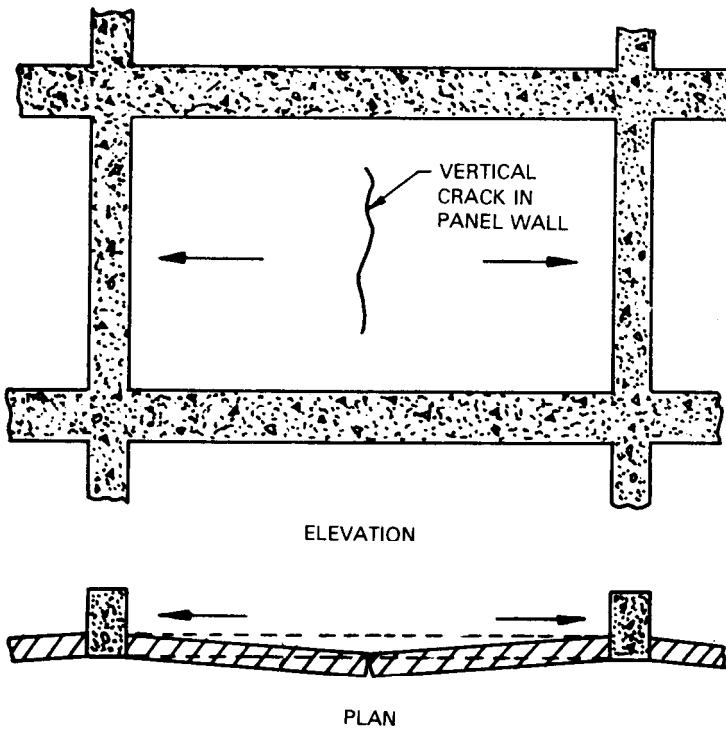

Fig. 32 Vertical Crack in Brick Panel Wall of Framed Structure Due to Expansion of Brickwork

upon the length-to-height ratio of the partition and position of door opening in the partition as under:

- a) *Case A* — Length-to-height ratio of partition is large (2 or more) and there is no door opening (see Fig. 33)

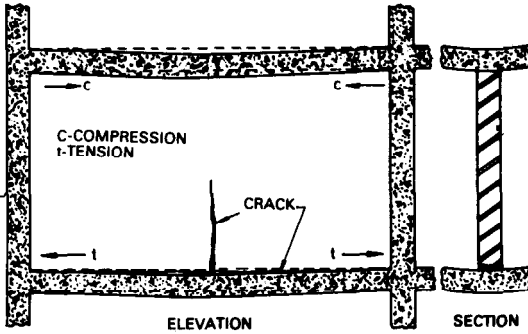

Fig. 33 Case A: Cracking in a Partition Wall Supported on RCC Slab/Beam, When Length to Height Ratio of Partition is Large, and there is no Door Opening

Due to deflection in the floor, middle portion of the partition loses support and because of large length-to-height ratio, load of the partition gets transferred to the ends of the support mostly by beam action. Thus, horizontal cracks occur in masonry at the support or one or more courses above the support. Also, vertical cracks occur near the bottom in the middle of the partition due to tensile stress, because of bending. These vertical cracks can be quite significant if the partition is built up to the soffit of the upper floor or beam and some load is transmitted to the partition due to the deflection of the latter. Shortening of columns supporting the floor due to elastic strain, creep and shrinkage, often aggravates the cracking of the partition.

- b) *Case B*— Length-to-height ratio is small (1.25 or less) and there is no opening in the partition (see Fig. 34):

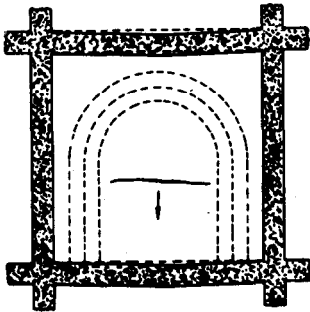

Fig. 34 Case B: Cracking in a Partition Wall Supported on RCC Slab/Beam, When Length to Height Ratio of Partition is Small and there is no Opening

In this case, self load of the partition is transmitted to the ends of the support, mainly by arch action and horizontal cracks occur at some height from the support because of tension developed due to self weight of unsupported portion of partition in the central region. There is not much of beam action in the partition in this case.

- c) *Case C*— Length-to-height ratio of partition is large and there is a central opening (see Fig. 35):

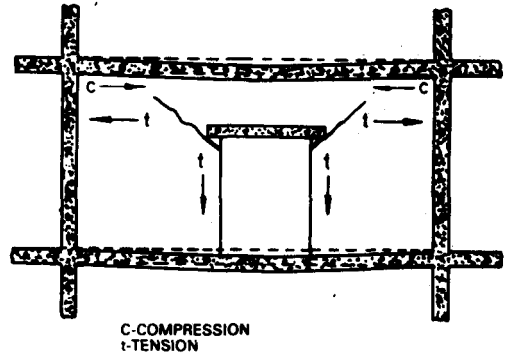

Fig. 35 Case C: Cracking in a Partition Wall Supported on RCC Slab/Beam, When Length to Height Ratio is Large and there is a Central Door Opening

In this case, diagonal cracks occur because of combined action of flexural tension in the portion of masonry above the opening and self weight of unsupported masonry on the sides of the opening. Cracks start from lintels where they are widest and get thinner as they travel upward.

- d) *Case D*— Length-to-height ratio of partition is small and there is a central door opening (see Fig. 36):

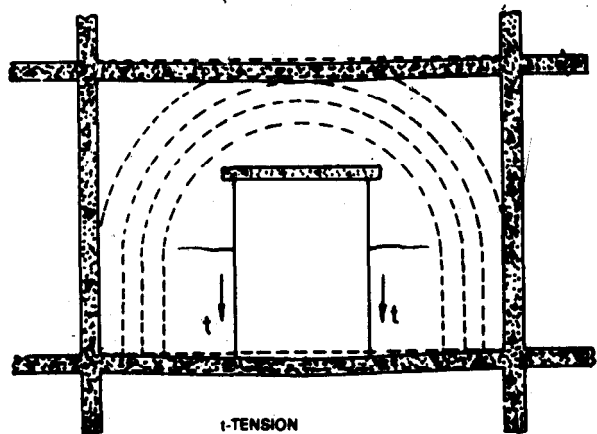

Fig. 36 Case D: Cracking in a Partition Wall Supported on RCC Slab/Beam, When Length to Height Ratio is Small and there is a Central Door Opening

In this case, horizontal crack occurs in the lower portion of the partition, mainly because of tension due to self weight of unsupported masonry on the sides of the opening.

- e) *Case E*—Length-to-height ratio is large and opening is off-centre (see Fig. 37):

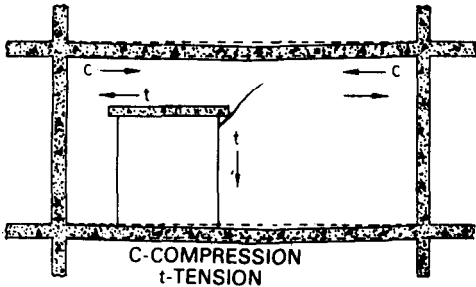

Fig. 37 *Case E: Cracking in a Partition Wall Supported on RCC Slab/Beam, When Length to Height Ratio is Large and there is an Off-Central Door Opening*

In this case, diagonal cracks occur as shown due to combined action of flexural tension in the portion of masonry above the opening and horizontal tension in the unsupported portion of masonry on the side of the opening due to loss of support in the middle. It is important to note that a partition with off-centre opening is more prone to cracking than that with central opening.

- f) *Case F*—Length-to-height ratio of partition is small and opening is off-centre (see Fig. 38):

In this case, crack is mainly due to tension caused by self-load of unsupported masonry on one side of the opening; there is not much of beam action in the masonry in this case.

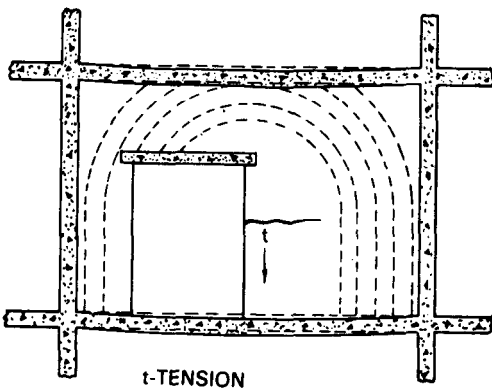

Fig. 38 *Case F: Cracking in a Partition Wall Supported on RCC Slab/Beam, When Length to Height Ratio is Small and there is an Off-Centre Door Opening*

5.10 *General Measures for Avoidance or Minimization of Cracks due to Elastic Strain, Creep and Shrinkage*

5.10.1 Though it may not be possible to eliminate cracking altogether, following measures will considerably help in minimization of cracks due to elastic strain, creep and shrinkage:

a) *General:*

- 1) Use concrete which has low shrinkage and low slump (see 2.3.3).
- 2) Do not adopt a very fast pace of construction.
- 3) Do not provide brickwork over a flexural RCC member (beam or slab) before removal of centering, and allow a time interval of at least 2 weeks between removal of centering and construction of partition or panel wall over it.
- 4) When brick masonry is to be laid abutting an RCC column, defer brickwork as much as possible.
- 5) When RCC and brickwork occur in combination and are to be plastered over, allow sufficient time (at least one month) to RCC and brickwork to undergo initial shrinkage and creep before taking up plaster work. Also, either provide a groove in the plaster at the junction or fix a 10 cm wide strip of metal mesh or lathing over the junction to act as reinforcement for the plaster.
- 6) In case of RCC members which are liable to deflect appreciably under load, for example, cantilevered beams and slabs, removal of centering and imposition of load should be deferred as much as possible (at least one month) so that concrete attains sufficient strength, before it bears the load.

b) *Panel walls in RCC framed structures:*

- 1) As far as possible, all frame-work should be completed before taking up masonry work of cladding and partitions which should be started from top storey downward.
- 2) Provide horizontal movement joint between the top of brick panel and soffit of beam. Where structurally required, provide lateral support for the panel at the top by using telescopic anchorage [see item (ii)(b) of Table 5 and Fig. 24] or similar restraints that permit movement in the vertical direction but can take horizontal shear due to wind, etc.

c) *Partitions supported on floor slab or beam:*

- 1) Provide upward camber in floor slab/beam so as to counteract deflection.
- 2) Defer construction of partitions and plaster work as much as possible.
- 3) Provide horizontal expansion joints between the top of masonry and soffit of beam/slab, filling the gaps with some mastic compound.
- 4) Provide central door openings in preference to off-centre openings.
- 5) Provide horizontal reinforcement in masonry, partition which have large (exceeding 2) length-to-height ratio. It should be ensured that masonry partitions which are reinforced do not get wet, as otherwise reinforcement may rust and cause cracks in the partition.

SECTION 6 MOVEMENT DUE TO CHEMICAL REACTION

6.1 *General*—Certain chemical reactions in building materials result in appreciable increase in volume of materials, and internal stresses are set up which may result in outward thrust and formation of cracks. The materials involved in reaction also get weakened in strength. Commonly occurring instances of this phenomenon are: sulphate attack on cement products, carbonation in cement-based materials, corrosion of reinforcement in concrete and brickwork, and alkali-aggregate reaction.

6.2 Sulphate Attack

6.2.1 Soluble sulphates which are sometimes present in soil, ground water or clay bricks react with tricalcium aluminate content of cement and hydraulic lime in the presence of moisture and form products which occupy much bigger volume than that of the original constituents. This expansive reaction results in weakening of masonry, concrete and plaster and formation of cracks. For such a reaction to take place, it is necessary that soluble sulphates, tricalcium aluminate and moisture—all the three are present.

6.2.2 In buildings, the main components which are liable to sulphate attack are concrete and masonry in foundation and plinth, and masonry and plaster in superstructure. The chemical reaction proceeds very slowly and it may take about two or more years before the effect of this reaction becomes apparent. Movement and cracks due to this reaction in structures thus

appear after about two years and these thus could be distinguished from cracks due to other causes from consideration of age of structure at the time when cracks start appearing in a structure.

6.2.3 Severity of sulphate attack in any situation depends upon:

- a) amount of soluble sulphates present;
- b) permeability of concrete and mortar;
- c) proportion of tri-calcium aluminate present in the cement used in concrete and mortar; and
- d) duration for which the building components in question remain damp.

Soluble sulphates normally found in a soil are those of sodium, potassium, magnesium and calcium. Strong and rich concretes and mortars can resist the sulphate attack better than weak and lean concretes and mortars. When sulphates are present, minimum cement content and maximum water-cement ratio are specified in order that concretes and mortars could resist sulphate attack. Percentage of tri-calcium aluminate in ordinary Portland-cement varies between 8 and 13, and greater the percentage of this constituent, greater its susceptibility to sulphate attack¹¹. In situations where it is necessary to increase the sulphate resistance of concretes and mortars, sulphate resisting Portland cement with tri-calcium aluminate content not exceeding 3.5 percent or supersulphated cement are specified¹². When water table is high, sulphates present in soil get dissolved in water and sulphates in solution attack the foundation concrete as well as cement mortar used in masonry in foundation and plinth. Similarly, continuous dampness in superstructure, either due to leakage from water supply or drainage system or due to long spells of rain, beating against walls or leaking through roof will, in course of time, result in cracks in masonry as well as plaster.

6.2.4 Sulphate attack on concrete and mortar of masonry in foundation and plinth would result in weakening of these components and may, in course of time, result in unequal settlement of foundation and cracks in the superstructure.

6.2.5 If brick aggregate used in base concrete of flooring contains too much of soluble sulphates (more than 1 percent) and water table is high so as to cause long spells of dampness in the base concrete, the latter will in course of time swell up resulting in upheaving and cracking of the concrete floor. Upheaving of a concrete tile floor due to sulphate attack is shown in Fig. 39.

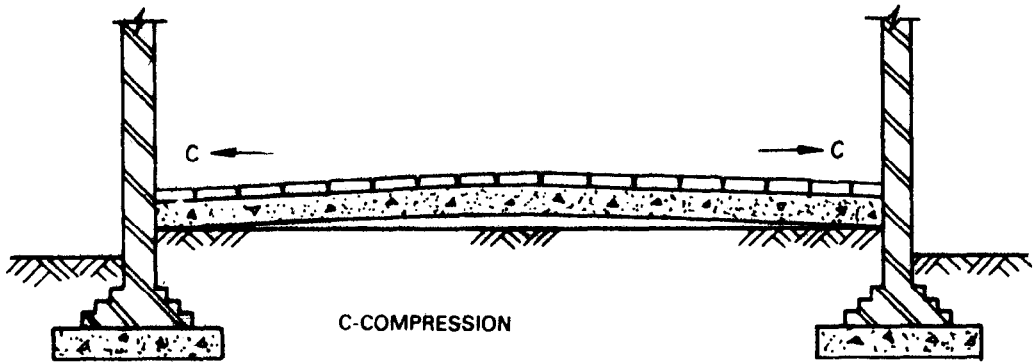

Fig. 39 Cracking and Upheaving of a Tile Floor Due to Sulphate Action in Base Concrete

6.2.6 If bricks used in masonry contain more than 3 percent of soluble sulphates, ordinary Portland cement is used in mortar for masonry and plaster, and if a wall remains damp for a long time, it may oversail at the membrane of DPC as shown in Fig. 40. This happens because of differential movement between superstructure and substructure because of restraint caused by the ground. This defect may appear two or three years after construction.

6.2.7 GENERAL MEASURES FOR AVOIDANCE OF SULPHATE ATTACK

- a) In case of structural concrete in foundation, if sulphate content in soil exceeds 0.2 percent or in ground water exceeds 300 ppm, use very dense concrete and either increase richness of mix to 1:1½:3 or use sulphate resisting Portland cement/super-sulphated cement or adopt a combination of the two methods depending upon the sulphate content of the soil. Similarly, in case of mortar for masonry, increase the richness of mix (1:½:4½ or 1:¼:3, cement:lime:sand) or use special cement as mentioned above or adopt a combination of the two methods.
- b) For superstructure masonry, avoid use of bricks containing too much of soluble sulphates (more than 1 percent in exposed situations, such as parapets, free standing walls and masonry in contact with damp soil as in foundation and retaining walls; and more than 3 percent in case of walls in less exposed locations)³⁸ and if use of such bricks cannot be avoided, use rich cement mortar (1:½:4½ or 1:¼:3) for masonry as well as plaster or use special cements mentioned earlier and take all possible precautions to prevent dampness in masonry. In certain situations, for example, compound and parapet walls, it may be necessary to introduce expansion joints at closer intervals, so as to make

adequate provision for expansion of masonry.

- c) Gypsum plaster, because of its sulphate content chemically reacts with Portland cement in the presence of moisture. For this reason, gypsum plaster should never be gauged with cement and it should not be used in locations where the wall is likely to get damp. Thus, gypsum plaster is not suited for external work which is liable to get wet due to rain.

6.3 Carbonation

6.3.1 When concrete hardens due to hydration of cement, some calcium hydroxide is liberated which sets up a protective alkaline medium inhibiting galvanic cell action and preventing corrosion of steel. In course of time, free hydroxide in concrete reacts with atmospheric carbon dioxide, forming calcium carbonate, resulting in shrinkage cracks. This reaction known as 'carbonation' also lowers alkalinity of concrete and reduces its effectiveness as a protective medium. In good quality dense concrete, carbonation is confined mainly to surface layers of concrete and depth of carbonation may not exceed 20 mm in 50 years. In porous concrete, carbonation may reach a depth of 100 mm in 50 years. (Thus, when concrete is permeable or when reinforcement is very close to surface because of inadequate cover, carbonation results in corrosion of reinforcement). Carbonation is more rapid in a dry atmosphere but, since presence of moisture is necessary for galvanic action to take place, for corrosion of steel, an alternating dry and wet weather is more conducive to corrosion.

6.3.2 In industrial towns, having higher percentage of carbon dioxide in the atmosphere because of pollution, cracking caused in concrete due to carbonation is comparatively much more. Such cracks can be avoided or minimized by ensuring use of

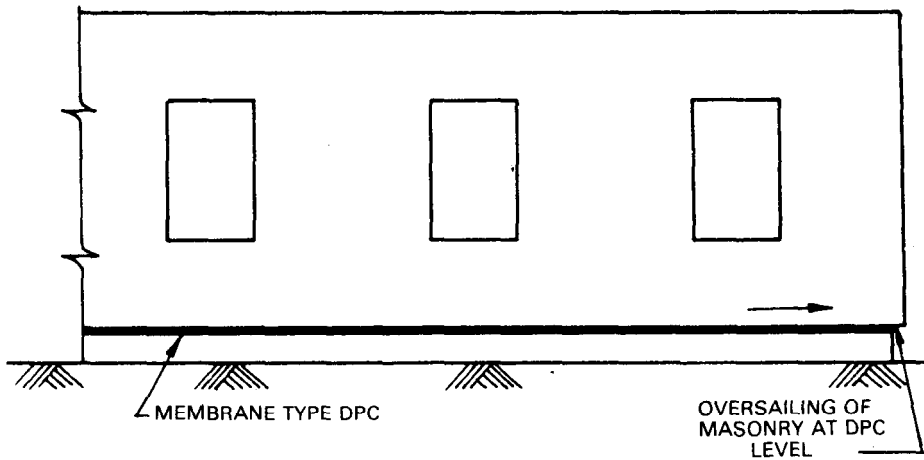

Fig. 40 Oversailing of Brick Masonry at DPC Level Due to Expansion

dense and good quality concrete and limiting the width of elastic cracks in structural design to 0.30 mm for protected internal members and to 0.20 mm for unprotected external members as stated earlier in 6.2.3(a)¹².

6.3.3 In asbestos cement sheets, because of their large surface to volume ratio, carbonation plays a significant role in causing cracks. These cracks are prevented by applying protective coats of paint on both sides¹⁷.

6.3.4 Occurrence of carbonation in case of masonry units of cellular or light-weight concrete is quite substantial, because carbon dioxide from atmosphere can penetrate to a considerable depth on account of porosity of the material. This reaction, therefore, accentuates shrinkage cracks in masonry employing these units. Curing of these units during manufacture with steam at atmospheric pressure causes pre-carbonation and considerably reduces subsequent shrinkage.

6.4 Corrosion of Reinforcement

6.4.1 Under most conditions concrete provides good protection to steel embedded in it. Protective value of concrete depends upon high alkalinity and relatively high electrical resistivity of concrete, extent of protection, depending upon the quality of concrete, depth of concrete cover and workmanship.

6.4.2 Corrosion of reinforcement is an electro-chemical process and for that a necessary precondition is the formation of a galvanic cell which comprises two electrodes— anode and cathode, separated by an electrolyte and connected in an electrical circuit. Anode reaction of the cell involves dissolution of metal and its combination with oxygen to form iron oxide. Concrete always

contains some moisture as such and acts as an electrolyte.

6.4.3 Factors which lead to corrosion of reinforcement in concrete and reinforced brickwork are:

- a) PRESENCE OF CRACKS IN CONCRETE BRICKWORK — Certain amount of cracking always occurs in the tension zone of RCC and reinforced brickwork, depending upon the amount of tensile stress in steel. Maximum permissible width of elastic cracks in RCC members would depend upon environments and other factors. For normal environmental conditions, one research authority after long investigations has recommended a maximum crack width of 0.30 mm for protected internal members and 0.20 mm for unprotected external members¹³. This could be taken as a general guide.
- b) PERMEABILITY OF CONCRETE — This is a major factor affecting corrosion of reinforcement. From this consideration, quantity of cement in concrete should not be less than 350 kg/m³ and water-cement ratio should not exceed 0.55 for ordinary structures and 0.45 for marine structures. All other normal requirements of good quality concrete, namely, grading and cleanliness of aggregates, thorough mixing, adequate compaction and curing, etc, should be taken care of.
- c) CARBONATION — Part played by carbonation in causing corrosion of reinforcement in concrete has been discussed earlier in 6.3.1 and 6.3.2 (see Photo 8).
- d) CORROSION CELLS — Corrosion cells are formed when there is difference in moisture content, electrolyte concentration, oxygen concentration, and when dissimilar metals are present.

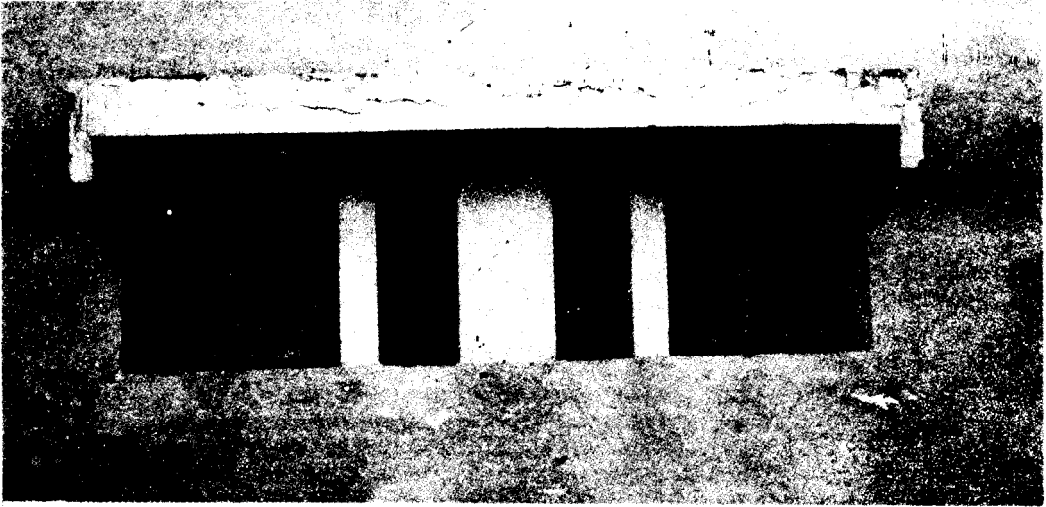

Photo 8 Cracks in RCC Sun Shade Due to Corrosion of Reinforcement, Because of Carbonation, Concrete not being of Good Density

- e) **ELECTROLYSIS** — Passage of direct electric current through concrete or reinforcement can cause rapid and serious corrosion. This may happen if there is electrical leakage of direct current and electrical system is not effectively grounded.
- f) **ALKALI-AGGREGATE REACTION** — If alkali-aggregate reaction takes place, concrete is weakened and develops cracks and thus is no longer in a position to afford adequate protection to steel reinforcement. This phenomenon of alkali-aggregate reaction has been discussed in more details in 6.5.
- g) **USE OF CALCIUM CHLORIDE (CaCl_2) AS ACCELERATOR** — Sometimes a small percentage of calcium chloride is used in concrete as an accelerator. This leads to rapid corrosion of reinforcement as it reduces electrical resistivity of concrete and helps to promote galvanic action. At the same time, it increases shrinkage cracks in concrete. Thus, use of calcium chloride (CaCl_2) in concrete as accelerator should be avoided. If its use is unavoidable under any circumstances, its quantity should be limited to 1.5 percent (by weight of cement) and low water-cement ratio, adequacy of cement content, good grading of aggregates, adequacy of cover to reinforcement and good compaction should be ensured.
- h) **INGRESS OF SEA WATER INTO PORES OF CONCRETE** — In case of marine structures, if concrete is not sufficiently impervious, ingress of sea water which contains about 3.5 percent of chlorides, results in reduction of alkalinity of concrete, thus resulting in rapid corrosion of steel. Portions of concrete which are not permanently submerged and undergo alternate wetting and drying, are more susceptible to damage. Factors as mentioned in 6.4.3(g) should be taken care of.
- i) **PRESENCE OF MOISTURE** — Presence of moisture in concrete is a precondition for corrosion to take place because concrete can act as an electrolyte only if it contains some moisture. In a hot and humid country like India, relative humidity above 75 percent as prevailing in coastal areas, causes rapid corrosion of reinforcement and calls for special attention (for example, good cover, low water cement ratio, use of well graded aggregates, good compaction and adequate curing). It is, therefore, necessary that in areas of high humidity, concrete should be of low permeability.
- j) **PRESENCE OF SOLUBLE SULPHATES** — If water containing soluble sulphates and cement used in cement concrete and cement mortar come in contact with each other, chemical action between the two results in expansion of concrete as well as corrosion of reinforcement. This aspect has been discussed in details earlier in 6.2.
- k) **INADEQUACY OF COVER** — If concrete cover to reinforcement is inadequate, latter is liable to get corroded too soon due to various factors, such as carbonation, ingress or spray of sea water, moisture from rain and humidity in the atmosphere. It is, therefore, necessary that RCC work should have minimum cover as recommended in IS: 456-1978¹⁹ and cover should be suitably increased in aggressive environments¹⁸.

Exposed concrete items in thin sections, such as sunshades, fins and louvres of buildings, are susceptible to early cracking and rapid dismemberment due to inadequacy of cover together with use of high slump concrete and improper compaction, etc. To prevent such cracking and premature deterioration, it is desirable to specify concrete of richer mix (say 1:1½ :3) for thin sections in exposed locations and to take special care about grading, slump, compaction and curing of concrete.

n) **IMPURITIES IN MIXING AND CURING WATER**—Impurities, such as sulphates and chlorides, when present in mixing and curing water in excess of certain concentrations, can lead to early and rapid corrosion of reinforcement in RCC work. IS:456-1978¹⁹ has laid down the following limits in this regard:

Total inorganic compounds	: 3000 mg/l
Sulphates (as SO ₄)	: 500 mg/l
Chlorides (as Cl)	: 2000 mg/l for plain concrete
	: 1000 mg/l for RCC

Mixing or curing with sea water is not recommended because of presence of

harmful salts in sea water. Under unavoidable circumstances, sea water could be used in plain concrete or such reinforced concrete work which is permanently under sea water.

6.4.4 As steel gets corroded, it increases in volume thus setting up internal stress in concrete. In course of time it first causes cracks in line with the direction of reinforcement and later causes spalling of concrete, dislodging cover of reinforcement from the body of the concrete, thus seriously damaging the structure.

6.4.5 In reinforced brickwork, process of corrosion of reinforcement is similar to that in concrete, except that, it is more rapid and life expectancy of such work is much less. Moreover, in this work thickness of concrete or cement mortar surrounding the reinforcement (that is cover) is comparatively much less and thus deterioration is much more rapid (see Photo 9). It is very important that bricks used in reinforced brickwork should have low porosity and should not contain more than 1 percent of soluble salts. That explains why reinforced brickwork is not successful in regions where quality of bricks as locally produced is not of high standard. Ensuring adequate cover to reinforcement, using bricks of good quality and preventing ingress of moisture to reinforced brickwork are some of the more important measures for



Photo 9 Horizontal Cracks in Compound Wall of Brickwork, having Horizontal Reinforcement; Brickwork being Exposed to Weather and Rain, Reinforcement has been Corroded, Resulting in Cracks; This Wall was Built in 1967

preventing early cracking and failure of reinforced brick structures.

6.5 Alkali-Aggregate Reaction

6.5.1 In ordinary Portland cement alkalis namely, sodium oxide, (Na_2O) and potassium oxide (K_2O) are present to some extent. These alkalis chemically react with certain silicious mineral constituents of some aggregates and cause expansion, cracking and disintegration of concrete. In case of RCC, cracking due to alkali-aggregate reaction gives rise to corrosion of reinforcement that may result in structural failure. Cracking due to this cause is usually of map pattern, and reaction being very slow, it takes a number of years for cracks to develop.

6.5.2 Preventive measures consist of avoiding use of aggregates which on testing have been found to be alkali-reactive. If use of such aggregates cannot be avoided or there is some doubt about the properties of aggregates in this regard, cement with alkali content not exceeding 0.6 percent (equivalent Na_2O) should be specified²⁷. When low alkali cement is not available economically, use could be made of some suitable pozzolanic material which prevents alkali-aggregate reaction by itself combining with the alkalis present in cement. Pneumatically applied mortar or concrete is a convenient and successful method of repairing an RCC structure where some damage has occurred due to the phenomenon under discussion.

6.5.3 There are a number of known tests for detecting occurrence of reactive aggregates. These are mortar bar test, quick chemical test and petrographic test, the last named test being quite reliable and by far the best¹⁹. Instances of some reactive rocks are opaline or calchedenic lime stones and dolomites. Based on studies made in USA aggregates containing more than 0.25 percent of opal or more than 5 percent of calchedony or more than 3 percent of glassy or crypto crystalline acidic to intermediate volcanic rocks or tuffs should be used as aggregate for concrete, only if cement, low in alkali content is obtainable²⁷.

SECTION 7 FOUNDATION MOVEMENT AND SETTLEMENT OF SOIL

7.1. Shear cracks in buildings occur when there is large differential settlement of foundation either due to unequal bearing pressure under different parts of the structure or due to bearing pressure on soil being in excess of safe bearing strength of the soil or due to low factor of safety in the design of foundation. Sometimes, differential settlements in buildings occur when there are local variations in the nature of supporting

soil and such variations are not detected and taken care of in the foundation design at the time of construction. In order to avoid settlement cracks in buildings, it is essential that designs for their foundations are based on sound engineering principles and good practice.

7.2 Buildings constructed on shrinkable clays (also sometimes called expansive soils) which swell on absorbing moisture and shrink on drying as a result of change in moisture content of the soil, are extremely crackprone and special measures are necessary to prevent cracks in such cases. Effect of moisture variation generally extends up to about 3.5 m depth from the surface and below that depth it becomes negligible²¹. Roots of fast growing trees, however, cause drying and shrinkage of soil to greater depth. Effect of soil movement can be avoided or considerably reduced by taking the foundation 3.5 m deep and using moorum, granular soil or quarry spoil for filling in foundation trenches and in plinth. Variation in moisture content of soil under the foundation of a building could be considerably reduced by providing a waterproof apron all round the building [see 9.5.1(n)]. Use of under-reamed piles in foundation for construction on shrinkable soils has proved effective and economical for avoiding cracks and other foundation problems. It is necessary that bulb of the pile is taken to a depth which is not much affected by moisture variations.

7.3 Cracks that occur due to foundation movement of a corner on an end of a building are usually diagonal in shape as shown in Fig. 41 (see also Photo 10). These cracks are wide at top and decrease in width downward. These cracks thus can be easily distinguished from those due to thermal or moisture movements.

7.4 In case of a building built on soil which is not very compact, sometimes settlement starts when water due to unusually heavy rains or unexpected floods gets into the foundation and causes settlement in the soil under load of the structure. Such a settlement generally not being uniform in different parts, results in cracking. Plinth protection around the building helps to some extent in preventing seepage of rain and surface water into the foundation, thereby obviating the possibility of settlement cracks.

7.5 Sometimes it becomes necessary to make a horizontal extension to an existing structure. Since foundation of a building generally undergoes some settlement as load comes on the foundation, it is necessary to ensure that new construction is not bonded with the old construction and the two parts (old and new) are separated by a slip or

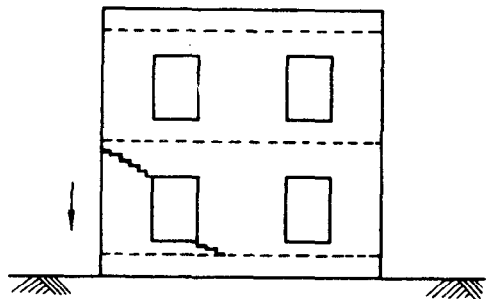

Fig. 41 Cracks at the Corner of a Building Due to Foundation Settlement

expansion joint right from bottom to the top, as otherwise when the newly constructed portion undergoes settlement, an unsightly crack may occur at the junction. Care should also be taken that in the vicinity of the old building, no excavation below the foundation level of that building is made. When plastering the new work a deep groove should be formed separating the new work from the old. If the existing structure is quite long (20 to 25 m), the old and new work should be separated by an expansion joint with a gap of about 25 to 40 mm so as to allow some room for unhindered expansion of the two portions of the building.

7.6 When it is intended to make horizontal extension to a framed-structure at some later date, it is necessary to provide twin columns at the junction with a combined footing for the foundation of the two columns. Foundation footing for the twin columns in question has to be provided at the time of original construction. This is illustrated in Fig. 42.

7.7 As walling work proceeds in a construction job, gradual settlement of foundation due to load on the soil takes place. To avoid differential settlement and consequent cracking in walls on this account, it is necessary to ensure that wall work proceeds more or less at a uniform level in all parts of the structure. Thus, specifications for building works generally stipulate that, difference in height of masonry in different parts of a building should not exceed 1.0 m at any time.

7.8 Sometime it is necessary to construct a building on a site which is low, and deep filling under the floors in plinth is required. If this filling is not well compacted, in course of time moisture or water from some source may find its way to the filled up soil and that may cause settlement of soil and cracks in floors. Thus, special precautions have to be taken to avoid possibility of cracking of floors, when filling is deep—say exceeding 1.0 m. Soil used for filling should be free from organic matter, brick-bats and debris; filling should be done in layers not exceeding 25 cm in thickness and each layer should be watered and well rammed. This requires very close supervision. If there is laxity of supervision or there is some doubt about the soundness of filling, bore holes about 1 metre apart in each direction should be made up to full depth of fill, area flooded with water and allowed to partially dry and then well compacted with wooden ballies and hand rammers. If filling is more than 1 metre in depth, process of flooding and compaction should be carried out after every metre of fill.

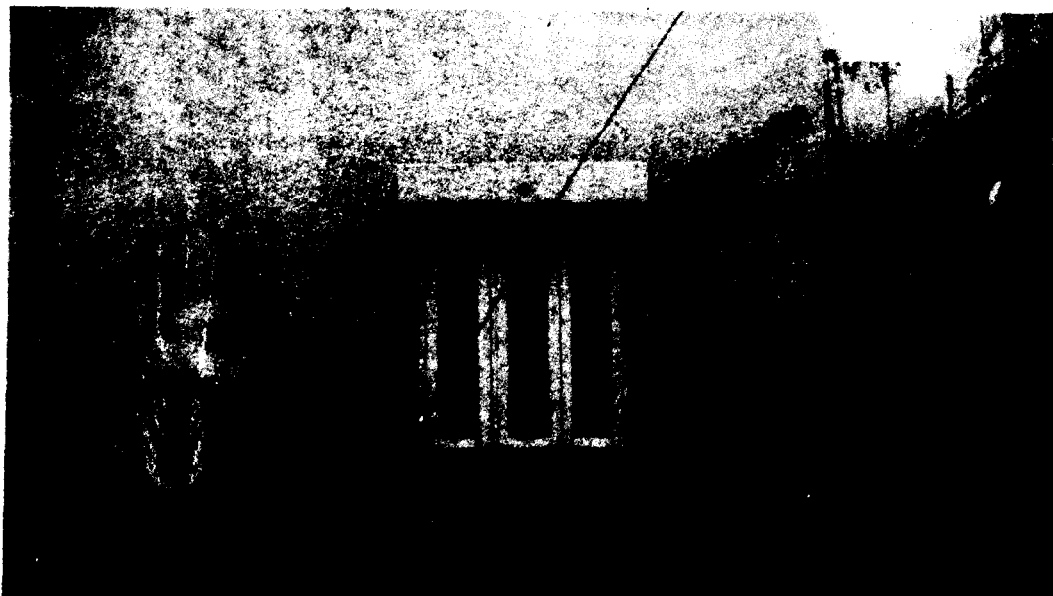

Photo 10 Diagonal Cracks in the Corner of a Building due to Foundation Settlement; Cracks have been Repaired by Filling them with Mortar and Replastering a Strip about 100 mm Wide Around the Cracks

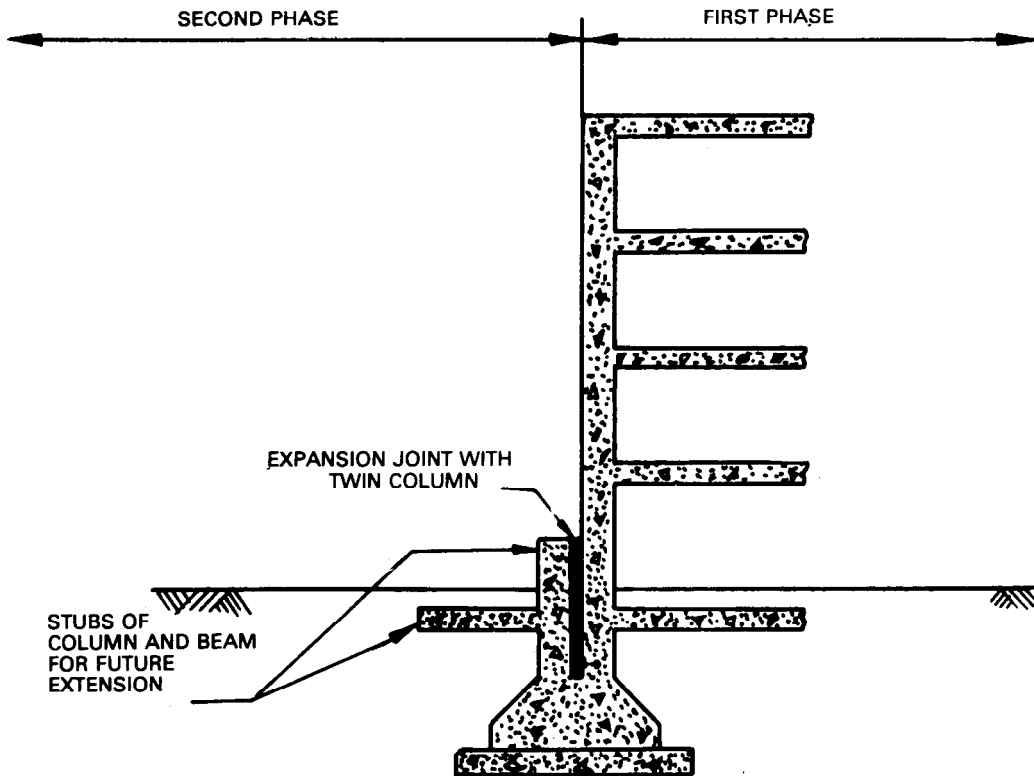

Fig. 42 Structural Provision for Horizontal Extension with an Expansion Joint, for RCC Framed-Structure

When a floor is required to take heavy loads as in grain godowns, warehouses and industrial buildings, degree of compaction, that is attained by the above method of filling would not be adequate. For such buildings, it is necessary to do filling in 25 to 30 cm layers with soil containing optimum moisture, compacting every layer of soil to 95 percent proctor density with the help of road rollers. Specifications for flooring should also be for heavy duty.

SECTION 8 CRACKING DUE TO VEGETATION

8.1 Existence of vegetation, such as fast growing trees in the vicinity of compound walls can sometimes cause cracks in walls due to expansive action of roots growing under the foundation. Roots of a tree generally spread horizontally on all sides to the extent of height of the tree above the ground and when trees are located close to a wall, these should always be viewed with suspicion.

8.2 Sometimes plants take root and begin to grow in fissures of walls, because of seeds contained in bird droppings. If these plants are not removed well in time, these may in course of time develop and cause severe cracking of the wall in question.

8.3 When soil under the foundation of a building happens to be shrinkable clay, cracking in walls and floors of the building can occur either due to dehydrating action of growing roots on the soil which may shrink and cause foundation settlement, or due to upward thrust on a portion of the building, when old trees are cut off and the soil that had been dehydrated earlier by roots, swells up on getting moisture from some source, such as rain.

8.4 A few examples of occurrence of cracks in structures, walls or floors due to vegetation are given below:

- Figure 43 shows a case where roots of a tree growing under the foundation of a compound wall cause cracks in the wall. These cracks are wide at the base and narrow down as they pass upwards.

Sometimes thrust exerted by the growing roots may overturn a compound wall as shown in Fig. 44.

- Figure 45 shows a case where trees growing close to a building founded on shrinkable soil cause shear cracks due to shrinkage of soil and settlement of foundation. These cracks are wide at top and get narrow as they travel downwards (see also Photo 11).

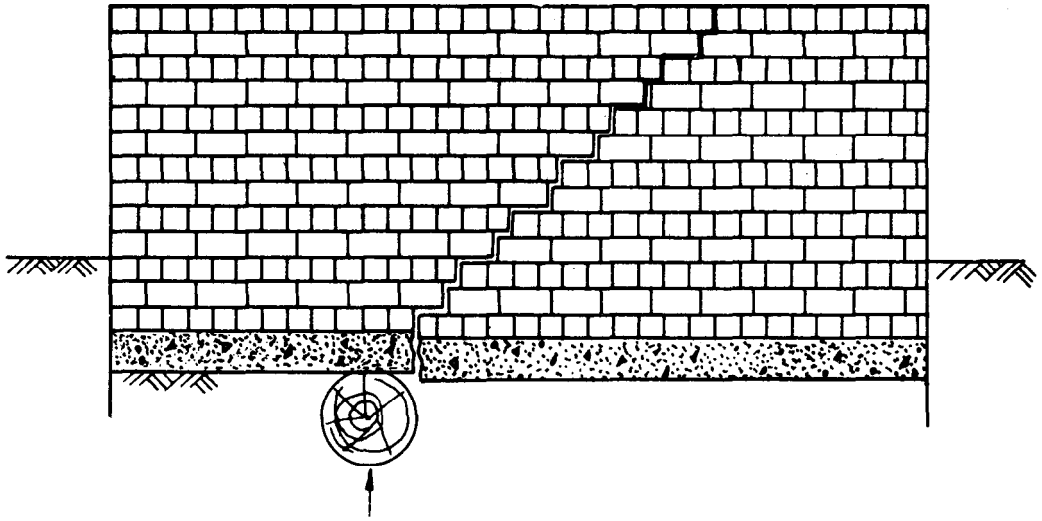

Fig. 43 Cracking of a Compound Wall Due to Growing Roots Under the Foundation

c) Figure 46 shows a case where old trees growing in the vicinity of a structure are cut off in order to clear the surroundings. In course of time, soil under the foundation which had been dehydrated by the trees absorbs moisture from rain, etc, and swells up so as to exert upward thrust on the foundation. This causes cracks in the building as shown. These cracks are wide at the base and get narrow as they travel upwards.

8.5 Following are some general measures for avoidance of cracks due to vegetation:

- a) Do not let trees grow too close to buildings, compound walls, garden walls, etc, taking extra care if soil under the foundation happens to be shrinkable soil/clay. If any saplings of trees start growing in fissures of walls, etc, remove them at the earliest opportunity.
- b) If some large trees exist close to a building and these are not causing any problem, as far as possible, do not disturb these trees if soil under the foundation happens to be shrinkable clay.
- c) If, from any site intended for new construction, vegetation including trees is removed and the soil is shrinkable clay, do not commence construction activity on that soil until it has undergone expansion after absorbing moisture and has stabilized.

SECTION 9 DIAGNOSIS AND REPAIR OF CRACKS

9.1 Cracking in structures is of common occurrence and engineers are often required

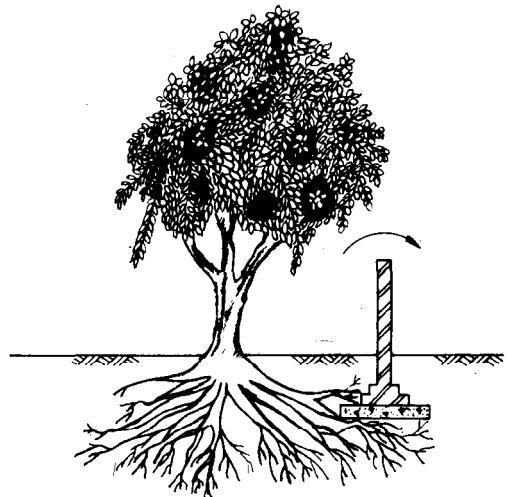

Fig. 44 Roots of Fast Growing Tree Under the Foundation of Compound Wall may Topple Down the Wall

to look into their causes and to carry out suitable repairs and remedial measures. For repairs and remedies to be effective, it is essential that the engineer should have proper understanding of various causes of cracking. For investigating the causes it is necessary to observe carefully location, shape, size, depth, behaviour and other characteristics of the cracks, and to collect information about specifications of the job, time of construction and past history of the structure. It will also be necessary for the engineer to know as to when the cracks first came to notice and whether the cracks are active or static. In order to decide about the activity of the cracks, use of telltales (see Appendix A) proves helpful.

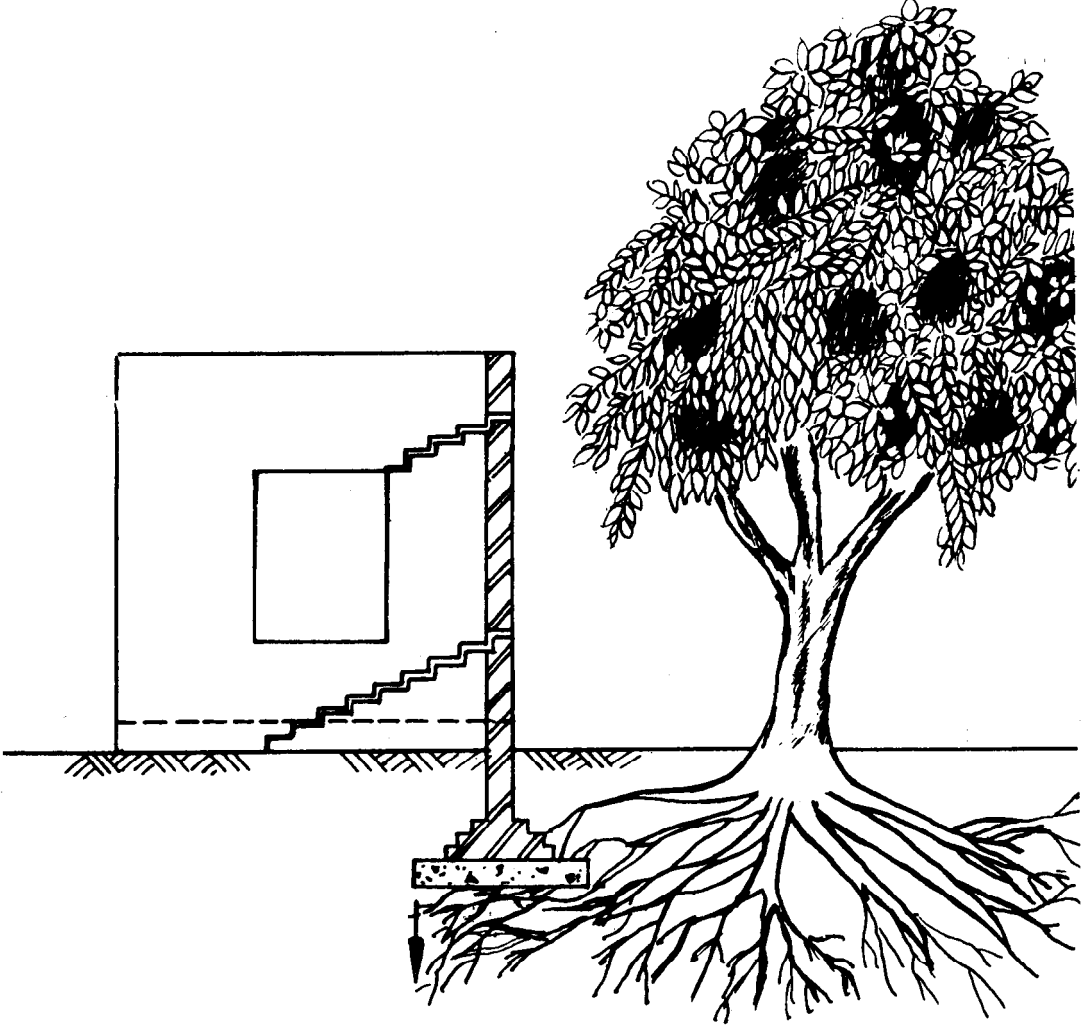

Fig. 45 Trees Growing Close to a Building on Shrinkable Soil may Cause Cracks in the Walls

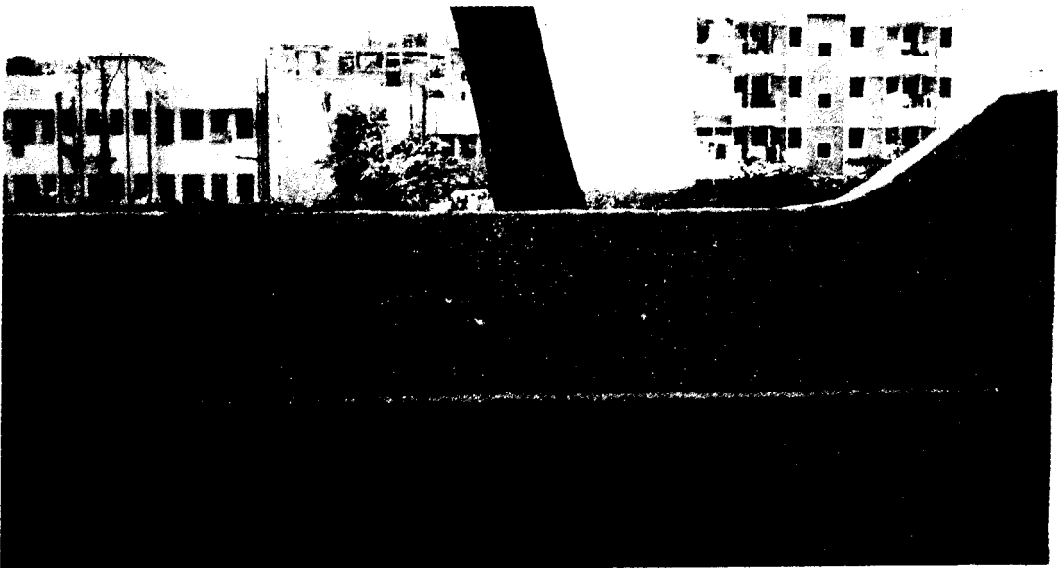

Photo 11 Cracks in a Compound Wall Due to Upward As Well as Sideward Thrust on the Foundation from Roots of a Growing Tree

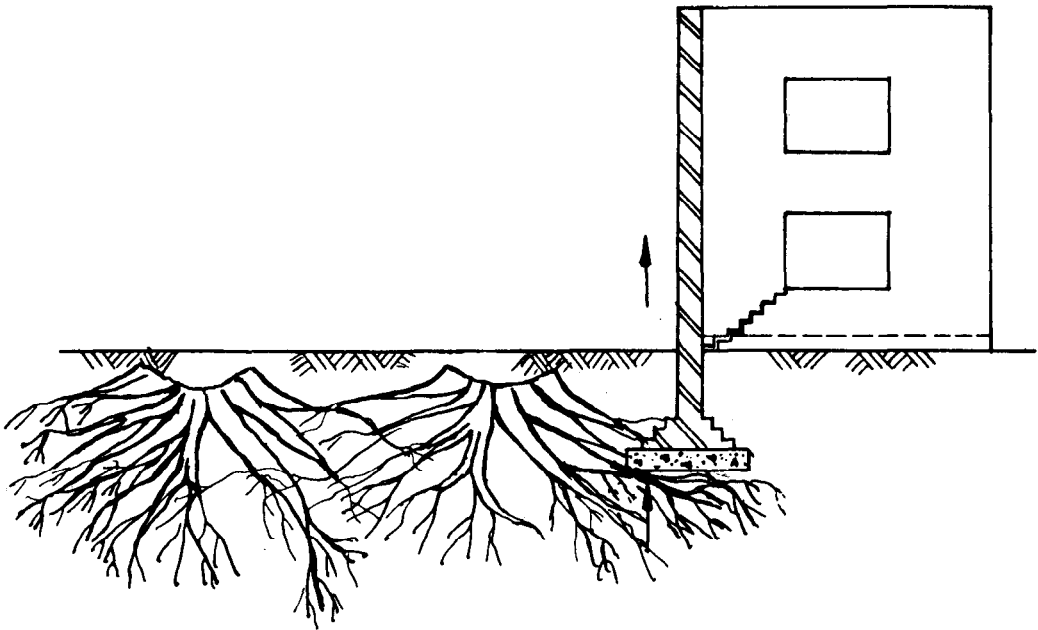

Fig. 46 Cracking Due to Expansion of Soil, if Construction is Taken up Soon After Removal of Trees .

9.2 A study of the previous sections of this Handbook will provide general background to the engineer to enable him to diagnose causes of cracks in any particular case. In this Section, some further guidance has been given to facilitate the task. Cracking due to deficiency in structural design, faulty construction and over-loading have not been discussed, that being outside the scope of this Handbook.

9.3 Generally speaking, for investigating causes of cracking in any particular case it is necessary to make careful observations and to collect detailed information in regard to the following aspects as may be relevant to a particular case:

- a) What is the past history of the structure in regard to year of construction, subsequent additions and alterations, major repairs, etc?
- b) What are the specifications of that part of the structure where cracks have occurred?
- c) When were the cracks first observed? Have the cracks since widened or extended? If the cracks are in walls; telltales (see Appendix A) should be fixed to monitor the progress of cracking.
- d) Do the cracks open and close with change in temperature during the course of a day?
- e) Are the cracks superficial or deep, and in the latter case, what is the depth of cracking? A fine steel wire may be used as a probe to measure the depth of a crack and where necessary, a small patch of the affected part may be removed to determine the depth of a crack. In case of walls, it should be ascertained whether the cracks are through or not, by examining both sides of the wall.
- f) What are the starting and ending points of the cracks? Have these any relation with the openings and weak sections in the buildings? Do the cracks start above DPC or do these pass through DPC and extend to the foundation?
- g) What are the geometrics of the cracks, that is, whether these are horizontal, vertical, diagonal or random, whether straight, toothed, stepped and whether of uniform width or tapering, etc. In case of vertical and diagonal cracks in walls, if cracks are straight, masonry units would also have cracked while toothed and stepped cracks would follow the course of vertical and horizontal joints in masonry. In case of tapering cracks, it should be observed as to which end of the crack is wider, that is, upper or lower.
- h) Do the cracks follow any set pattern in regard to direction and spacing? As an example, vertical cracks may occur in a

long compound wall at more or less uniform spacing of say 4 to 6 m all along the length, or in a building, diagonal cracks may occur over most of the door openings similarly situated, starting from the lintels and travelling upward in a direction away from the opening. In concrete floors, cracks may occur in most of the panels more or less in the middle, or diagonal cracks may occur at the corners.

- j) Is there any difference in the level on the two sides of a crack? This could be determined by moving tip of a finger across a crack or by putting a straight edge across the crack. By this check, tensile cracks could be distinguished from shear cracks and also bowing or curving of walls could be detected.
- k) Do the cracks have sharp or rounded edges? This could be found out by visual examination either with the naked eye or with the help of a magnifying glass. Rounded edges of cracks will mean alternate compressive and tensile forces as in case of thermal movements.
- m) Are the cracks accompanied by a bow in the member, if so, what is the extent of bow? A bow will indicate buckling of the member due to compressive force.
- n) Are there any signs of continuous dampness in the area affected by cracks? Is the area subjected to severe exposure to rain? Are there any indications of leakage of water from any source, such as water supply lines, storage stands, drains, rain, etc.
- p) Is the affected part of the structure subjected to long exposure to the sun?
- q) Are there any signs of general or local subsidence around the building? Is the building built on shrinkable clay soil? Does it have shallow foundation? Are there any special features about the growth of vegetation around the structure?
- r) Do the bricks used in the job contain excessive quantities of soluble sulphates? Does the soil or ground water under the structure contain excessive quantities of soluble sulphates? In this context proper tests will have to be got done.

9.4 Cracks in buildings usually occur in walls, RCC members, reinforced brickwork, renderings and plasters, concrete/terrazo floors and pavements, roof terrace, wood work, glass panes and glass blocks, asbestos

cement sheets, etc. Possible causes of cracks in these parts or components along with feasibility of repairs and remedial measures in specific cases, have been discussed in the following paragraphs, and general measures for carrying out repairs to cracks in walls have been suggested in 9.6. It has to be remembered that main emphasis should be on prevention of cracks, as in many cases there may be no satisfactory method of repairing the cracks after they have appeared.

9.5 Walls

9.5.1 EXTERNAL WALLS OF LOAD-BEARING STRUCTURES

- a) VERTICAL CRACKS IN THE SIDE WALLS AT THE CORNERS OF A LONG BUILDING AS SHOWN IN FIG. 47 — Cracks start from the DPC level and travel upward, are more or less straight and pass through masonry units and there is difference in the level on the two sides of the cracks. The cracks are due to thermal expansion sometimes aggravated by moisture expansion of brickwork and would be noticed during hot weather. There would be more chance of such cracks occurring in buildings constructed in cold weather.
- b) VERTICAL CRACKS NEAR THE QUOINS IN THE FRONT ELEVATION OF A LONG BUILDING HAVING SHORT RETURN WALLS AS SHOWN IN FIG. 9 — These cracks start upward from DPC level and are due to thermal expansion (sometimes aggravated by moisture expansion of brickwork) and occur when adequate provision for movement joints has not been made in the structure. The short return wall rotates due to thrust at two ends from the long walls thus resulting in vertical cracks. Movement in question can generally be accommodated without visible cracking if return wall exceeds 600 mm in length, that is, more than the length of 3 units.
- c) VERTICAL CRACKS IN THE TOP-MOST STOREY AT CORNERS OF A BUILDING HAVING RCC ROOF AS SHOWN IN FIG. 48 — Cause of this cracking is shrinkage of RCC roof slab on initial drying, as well as thermal contraction, which exerts an inward pull on the walls in both directions.

Since near the corners the walls cannot deflect because of interaction of the two walls at right angles to each other, bending in walls in portions away from corners, causes vertical cracks about one unit away from the corners. The dotted lines in Fig. 48B show the external walls before deflection and solid lines, after deflection.

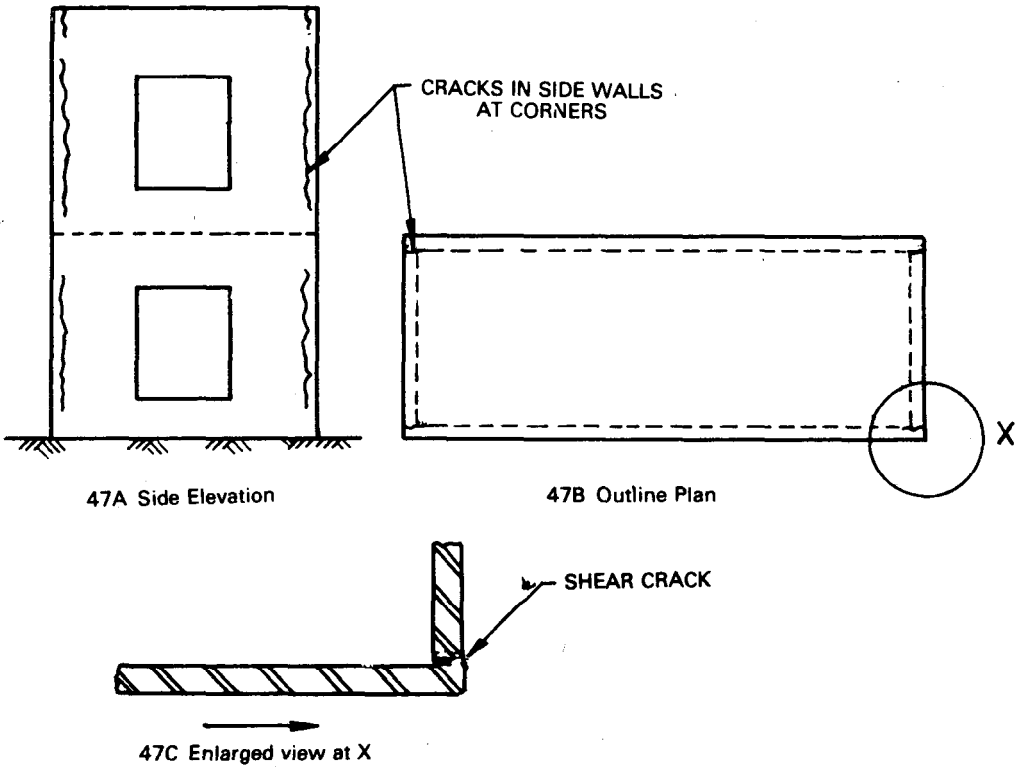

Fig. 47 Vertical Cracks at Corners in the Side Walls of a Long Building Due to Thermal Movement

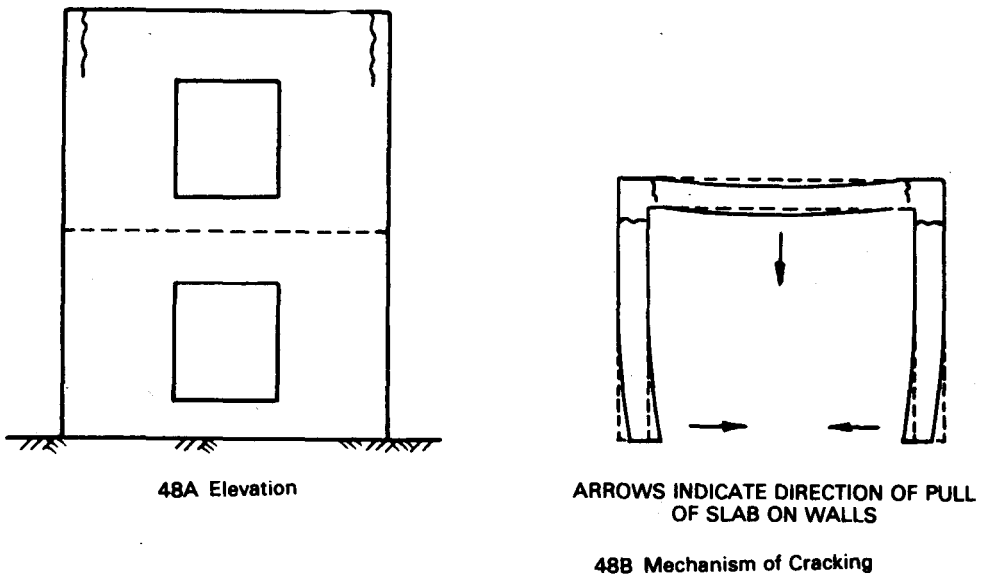

Fig. 48 Vertical Cracks at Corners in the Top Storey of a Building Due to Drying Shrinkage and Thermal Contraction of Slab

- d) VERTICAL CRACKS BELOW OPENINGS IN LINE WITH WINDOW JAMBS AS SHOWN IN FIG. 26 — These cracks are due to vertical shear caused by differential strain in the lightly loaded masonry below the opening and heavily loaded portion of wall having no openings.
- e) VERTICAL CRACKS AROUND STAIRCASE OPENING AS SHOWN IN FIG. 49 — These cracks are caused by drying shrinkage and thermal movement in a building and occur around staircase openings because of weakening in the wall as well as floor sections occurring at the staircase portion

of the building. These cracks are generally not very conspicuous.

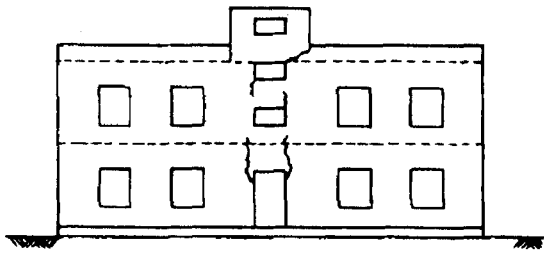

Fig. 49 Vertical Cracks in the External Wall around Staircase Openings in a Long Building

- f) VERTICAL CRACKS AROUND BALCONIES AS SHOWN IN FIG. 50—The cause for cracking in this case is the same as given in (e) above.

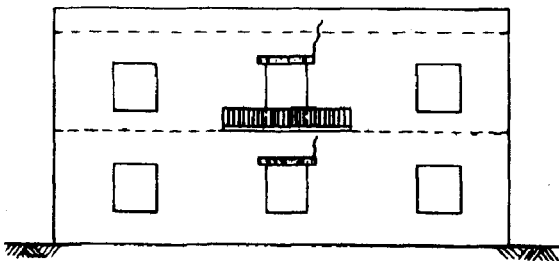

Fig. 50 Cracks in External Wall Around RCC Balcony

- g) HORIZONTAL CRACKS IN THE TOP-MOST STOREY BELOW SLAB LEVEL AS SHOWN IN FIG. 51—These cracks are due to deflection of slab and lifting up of edge of the slab, combined with horizontal

movement in the slab due to shrinkage. The cracks appear a few months after construction and are more prominent if the span is large. These cracks are mainly confined to the top-most storey because of light vertical load on the wall due to which, end of the slab lifts up without encountering much restraint. Measures to prevent these cracks have been discussed earlier in 4.4.

- h) HORIZONTAL CRACKS IN THE TOP-MOST STOREY, THE CRACKS BEING ABOVE THE SLAB WHEN SEEN FROM OUTSIDE AND BELOW THE SLAB WHEN SEEN FROM INSIDE AS SHOWN IN FIG. 52—These cracks are due to thermal expansion of the slab accompanied by bowing up which occurs due to thermal gradient in the slab. These cracks, if repaired with strong mortar, have a tendency to recur. On the outside, therefore, cracks should be repaired by filling with a mastic compound after widening and cleaning the crack or cracked portion replastered with a V-groove in plaster at the junction of masonry and slab. On the inside it should be repaired with weak composite mortar. In order to minimize thermal movement of the slab, insulation/protective cover on the top of the slab should be improved and terraces of important buildings provided with high reflectivity finish. If these measures are not adopted, cracks are likely to recur after filling.

- j) HORIZONTAL CRACKS AT WINDOW LINTEL OR SILL LEVEL IN THE TOP-MOST STOREY AS SHOWN IN FIG. 53—These cracks are due to pull exerted on the wall by the slab because of drying shrinkage and thermal

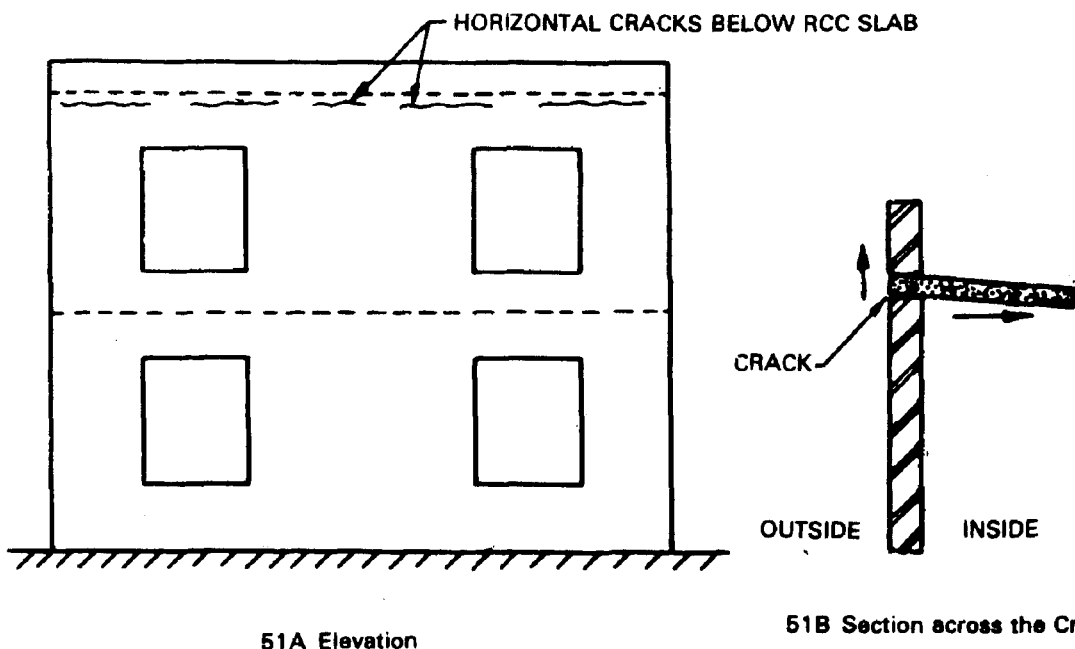

Fig. 51 Horizontal Cracks in Top-Most Storey Below Slab Due to Shrinkage and Deflection of Slab

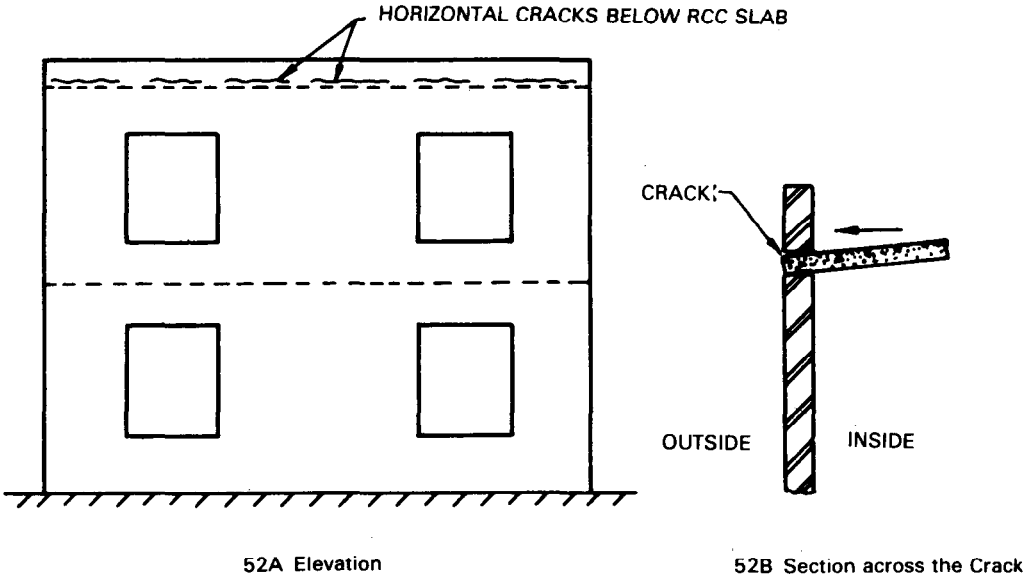

Fig. 52 Horizontal Cracks Above the RCC Slab in Top Most Storey Due to Arching and Expansion of Slab

contraction. This pull results in bending of the wall which causes cracking at a weak section, that is, at the lintel or sill level of the window openings. Such cracking generally occurs when windows and room spans are very large. These cracks could be avoided by providing slip joint at slab supports on the walls as explained earlier in 3.9(a) and illustrated in Fig. 12.

k) HORIZONTAL CRACKS IN THE TOP-MOST STOREY OF A BUILDING AT THE CORNERS AS SHOWN IN FIG. 54 — The cause of this type of cracking is the vertical lifting of slab corners due to deflection in the slab in both direction. In the lower storeys, lifting of slab corners is prevented by the vertical load of upper storeys and hence this type of cracking occurs only in the top storey. The cracking in question

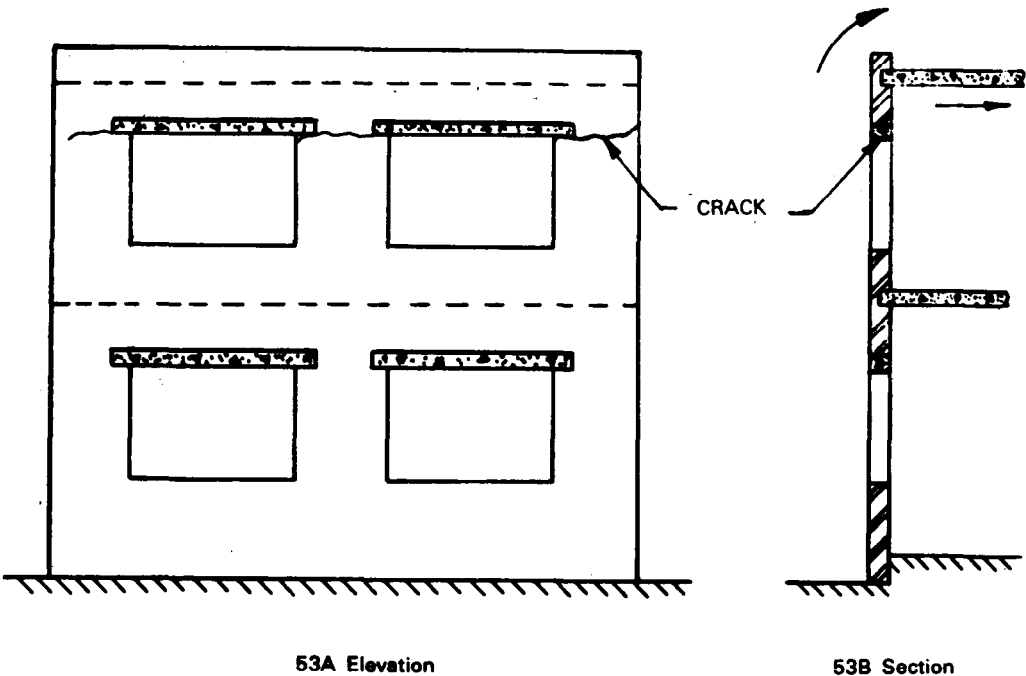

Fig. 53 Horizontal Cracks at Window Lintel Level in Top Most Storey

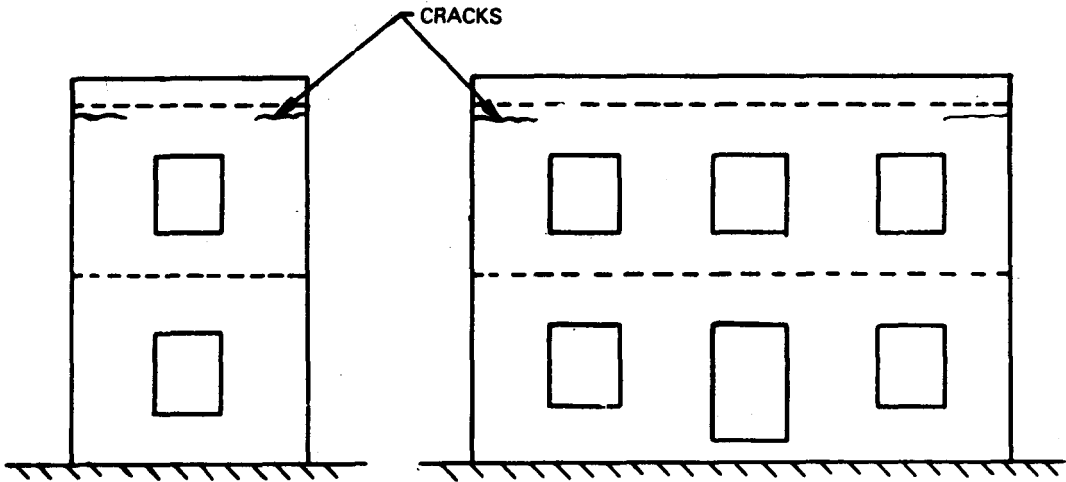

Fig. 54 Horizontal Cracks at Corners of Top Storey Below Slab Level Due to Lifting of Corners

could be avoided by providing adequate corner reinforcement in slabs.

- m) **HORIZONTAL CRACKS AT EAVES LEVEL IN CASE OF BUILDINGS HAVING PITCHED ROOFS WITH WOODEN TRUSSES AS SHOWN IN FIG. 55**—These cracks are more prominent on the inside of the building and occur when the building has become very old and roofing used is heavy, such as clay-tiles or slate. Principle cause of cracks in this case is the outward thrust from the roof truss because of weakening of structural timber due to dry rot or fungal attack, etc. The problem in question could be tackled by replacing the roof—if heavy, with some light material, for example G.I. sheets, A.C. sheets, giving some anti-fungal or other protective treatment to wood-work and providing steel ties between external walls. If the timber trusses have deteriorated appreciably, these may be replaced after rebuilding the cracked portion of the masonry.

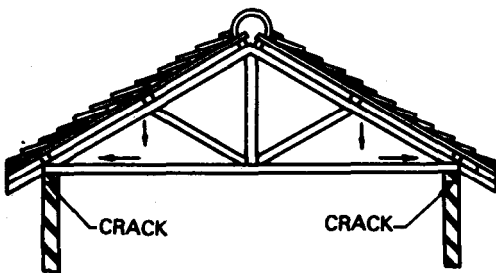
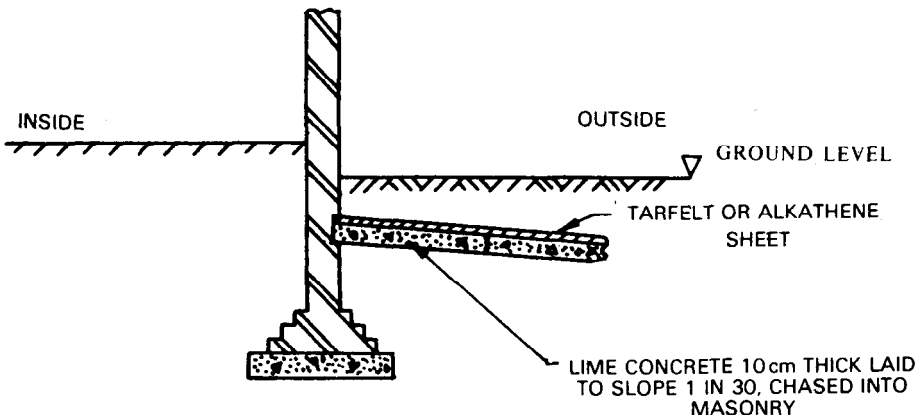

Fig. 55 Horizontal Cracks at Eaves Level of an Old Building with Pitched Roof, Due to Outward Thrust from Roof

- n) **DIAGONAL CRACKS ACROSS THE CORNER OF A BUILDING AFFECTING TWO ADJACENT WALLS AS SHOWN IN FIG. 41 AND 45**—Cracks are wider at the top and become narrow as they travel downward. Cracks pass through DPC and extend to foundation. These cracks are due to drying shrinkage of the foundation soil when building is built on shrinkable clay soil and has a shallow foundation. Drying out is likely to be more at corners and that is why generally corners are affected. Sometimes, fast growing trees close to the building accentuate the problem by the process of dehydration of soil. These cracks should not be filled up with rigid material until remedial work to prevent further movement has been done. One way of halting the soil movement is to provide a 2m wide flexible water-proof apron all-round the building at a depth of about 0.5m below the ground level as shown in Fig. 56. This work should be carried out when soil is neither too wet nor too dry, that is about a month or two after the monsoon. The apron may consist of a 10cm thick lime concrete layer laid to a slope of 1:30, covered with one or two layers of tarfelt or alkathene sheet²². The apron should be chased into the wall masonry to a depth of about 30 to 40 mm.

9.5.2 EXTERNAL AND INTERNAL WALLS OF LOAD-BEARING STRUCTURES

- a) **VERTICAL CRACKS IN WALLS BUILT WITH CONCRETE BLOCKS OR SAND-LIME BRICKS**—Cracks generally occur at weak sections, that is, at mid-point of openings or at regular intervals in long stretches. Cracks could be either straight, that is



(Based on Building Digest 91 of CBRIT²²)

Fig. 56 Flexible Waterproof Apron Around a Building to Reduce Moisture Variation in Soil Under the Building

passing through alternate courses of masonry units or toothed, that is passing through mortar joints only, depending upon relative strength of mortar and the masonry units. These cracks appear generally within a few weeks of construction of the wall and increase in width over a period of one or two years. Cracks generally get widened in cold weather. These cracks are due to drying shrinkage of masonry units and are more conspicuous when mortar used is too rich.

- b) VERTICAL CRACKS AT THE JUNCTION OF AN OLD PORTION OF A BUILDING AND NEW EXTENSION — These cracks are due to compaction of soil under load of the newly built portion of the building. These cracks could be repaired by filling them with weak mortar after further cracking has stopped, or by providing a vertical groove in the plaster at the junction.
- c) VERTICAL CRACKS AT THE JUNCTION OF RCC COLUMN AND MASONRY AS SHOWN IN FIG. 30 — These cracks appear a few months after construction and are due to differential strain between RCC and masonry because of elastic deformation, shrinkage and creep in RCC column. These cracks are generally thin and could be filled in at the time of renewal of finishing coat. If the cracks are conspicuous, a 10 cm wide strip of plaster around the crack may be removed and re-done after enlarging and filling the crack with mortar, 1 cement:2 lime:9 sand.
- d) HORIZONTAL CRACKS IN MORTAR JOINTS APPEARING TWO OR THREE YEARS AFTER CONSTRUCTION — These are due to sulphate attack. These cracks would be accompanied by weakening of mortar and these can be distinguished from

cracks due to other causes where no weakening of mortar is involved. There is no effective remedy against these cracks. As a palliative measure, plaster should be removed, mortar from the joints should be raked to a depth of about 25 mm and re-plastering done after filling the joints, using sulphate resisting cement.

- e) RIPPING CRACKS OCCURRING AT THE CEILING LEVEL IN CROSS WALLS AS SHOWN IN FIG. 11 — These cracks are due to relative movement between the RCC roof slab and the cross wall, movement of RCC slab being due to thermal expansion and contraction because of inadequate thermal insulation or protective cover on the roof slab. To remedy these cracks, thermal insulation or protective cover of roof slab should be improved and a groove in plaster should be introduced between the slab and the cross wall.
- f) DIAGONAL CRACKS IN CROSS WALLS OF A MULTI-STOURED LOAD BEARING STRUCTURE AS SHOWN IN FIG. 25 — These cracks are due to differential strain in the internal and external load bearing walls to which the cross walls are bonded. This type of cracking has been discussed earlier in 4.2
- g) DIAGONAL CRACKS ACCOMPANIED BY OUTWARD TILTING OF EXTERNAL WALLS; INTERNAL WALLS UNDERGOING RANDOM CRACKING AND FLOORS CRACKING UP AND BECOMING UNEVEN — This cracking is due to moisture movement of shrinkable soil, such as black cotton soil, when the foundation is shallow. In dry weather, the soil under the foundations shrinks and external walls settle down as well as tend to tilt outward because shrinkage is more at the periphery of the building and less in the inner regions. In

rains, the soil swells up and the movement is reversed but cracks once formed do not fully close. The floor heaves up and becomes unshapely. There is no effective remedy if the cracking is extensive. Moderate cracking could be controlled to some extent by providing water-proof apron as mentioned in 9.5.1(n). Sometime, cracked floors can be repaired by removing the old floor, base and soil up to 60cm depth, refilling the same with stone or brick ballast and relaying base concrete and flooring over it.

- h) **DIAGONAL CRACKS OVER RCC LINTELS SPANNING LARGE OPENINGS AS SHOWN IN FIG. 57**—These cracks start from ends of lintels travelling upwards in masonry away from the opening. These cracks are due to drying shrinkage of *in-situ* RCC lintels and are thus observed in the first dry spell after the completion of the building. These cracks could be avoided by using low-shrinkage and low slump concrete (see 2.3.3) for the lintels. These cracks do not occur when pre-cast lintels are used.

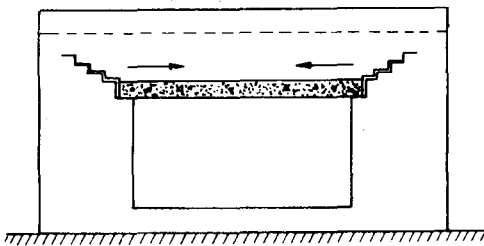

Fig. 57 Diagonal Cracks in Brick Masonry Wall over Lintels of Long Span Openings Due to Drying Shrinkage of Concrete

- j) **RANDOM CRACKS IN ALL DIRECTIONS INVOLVING BOTH EXTERNAL AND INTERNAL WALLS**—These cracks are generally due to either foundation settlement or sulphate action in the foundation concrete and masonry in foundation and plinth. Cracks may be thin, medium or wide. Foundation settlement could be due to construction having been done on made-up ground, unexpected flooding of the foundation, or mining subsidence. Cracks due to sulphate action in the foundation could be distinguished from those due to foundation settlement from a study of the past history of the case, and the consideration that cracks due to sulphate attack will generally start about 2 to 3 years after construction and progress very slowly. Tests on soil and ground water will confirm the presence of excessive quantity of soluble sulphates. In case of sulphate action, ground water table of the

area would be found close to the foundation. Cracking due to foundation settlement requires detailed investigations before any course of remedial measures could be decided upon.

9.5.3 PARTITION WALLS IN LOAD-BEARING STRUCTURES

- a) **PARTITION WALLS SUPPORTED ON RCC SLAB OR BEAM**—Cracks in these walls have been dealt with earlier in 5.9. Repair to these cracks are carried out as in the case of other walls. If wall is built tightly up to the soffit of the top beam or slab, horizontal joint between wall and beam or slab should be opened out and filled up with some joint filling compound or a horizontal expansion joint about 10 mm in width formed at the top of the wall.
- b) **PARTITION WALLS BUILT OF CONCRETE BLOCKS (DENSE OR LIGHT WEIGHT) OR SAND-LIME BRICKS**—Cracks are mostly vertical and are at junctions with the load bearing walls and at intermediate places when partition is long. If the wall is comparatively tall, horizontal cracks at the mid-height portion may also occur. These cracks are due to drying shrinkage of masonry units and could be quite conspicuous if partitions are very long or tall, mortar used is rich and precautions mentioned in item (4) of Table 2 have not been taken to avoid excessive shrinkage. Cracks could be repaired by first enlarging them and then filling them with weak mortar or by replacing the affected portion. If wall is built right up to the soffit of the beam or slab, an expansion joint should be introduced at the top as in 9.5.3(a).

9.5.4 **PARTITION WALLS IN RCC FRAMED STRUCTURES**—Remarks contained in 9.5.3 above hold good in this case also.

9.5.5 **PANEL WALLS IN RCC FRAMED STRUCTURES**—Horizontal cracks in panel walls of RCC framed structures occur if walls are built too tightly between the beams of the frame. These cracks, as shown in Fig.31, generally become apparent a few years after construction and are accompanied by bowing of the walls. Likelihood of damage due to these cracks is more if time interval between casting of frame and building up of brickwork has been small. These cracks are caused by compressive forces on the wall on account of shortening of RCC columns due to elastic deformation, shrinkage and creep. Cracking in question is aggravated by irreversible moisture expansion of brickwork if bricks are used soon after taking out of the kiln. To remedy these cracks, compressive

force in the panel should be relieved by opening out the horizontal joint between the top of the wall and the soffit of the beam and filling the joint with some joint filling compound. If damage is extensive and bowing is very conspicuous, rebuilding of panel wall may be necessary.

9.5.6 FREE STANDING WALLS, SUCH AS COMPOUND, GARDEN OR PARAPET WALLS

- a) VERTICAL CRACKS AT REGULAR INTERVALS OF 5 TO 8m AND AT CHANGE OF DIRECTION—These cracks are due to drying shrinkage combined with thermal contraction. Cracks tend to close in hot weather. If wide enough, cracks may be repaired by enlarging them and filling the same with weak mortar (1 cement : 2 lime : 9 sand). If no expansion joints have been provided earlier, some of the cracks may be converted into expansion joints.
- b) DIAGONAL CRACKS WHICH ARE TAPERING AND ARE WIDER AT THE TOP IN COMPOUND AND GARDEN WALLS—These are due to foundation settlement. If cracks are wide enough to endanger the stability of the wall, affected portion should be dismantled and rebuilt providing adequate foundation.
- c) DIAGONAL CRACKS WHICH ARE TAPERING AND ARE WIDER AT THE BOTTOM IN COMPOUND AND GARDEN WALLS—If there are any trees and plants growing in the vicinity of the wall, the cracks are likely to be due to upward thrust from roots growing under the foundation (see Fig. 43). If these cracks are ignored and no remedial measures are carried out in time, these cracks will widen and in course of time would endanger the stability of the wall (see Fig. 44). Remedy for these cracks lies in removing the offending roots of trees and plants and rebuilding the affected portion of the wall.
- d) BOWING UP OF THE COPING STONE OF A COMPOUND OR GARDEN WALL AND HORIZONTAL CRACKS BELOW THE COPING STONE—This will happen if the wall is built between two heavy structures which act as rigid restraints and no expansion joints have been provided in the coping stone (see Fig. 14). Remedy for this defect lies in relaying the affected portion of coping and providing expansion joints at suitable intervals [see Sl. No. (4) of Table 5].
- e) HORIZONTAL CRACKS IN THE BED JOINT OF FREE STANDING WALLS—If horizontal cracks in bed joints of masonry appear about two or three years after construction and the wall in

question has been subjected to periodic wetting for long spells and at the same time mortar has weakened, cracks in question are likely to be due to sulphate action. This should be confirmed by chemical tests of the mortar and the bricks. There is no effective remedy for these cracks and the damaged portion has to be rebuilt when it becomes unserviceable using sulphate-free bricks and if that is not feasible, using sulphate resisting cement and taking other precautions for preventing recurrence of sulphate attack (see 6.2.7).

9.6 General Measures for Repairing Cracks in Masonry Walls

9.6.1 Main purpose of carrying out repairs to cracks in masonry walls is firstly to restore normal appearance, secondly to minimize the possibility of cracks causing further damage to the building and thirdly to ensure that the building is serviceable and safe. Walls which are not more than 25 mm out of plumb, or which do not bulge more than 10 mm in a normal storey height, would not generally need repairs on structural ground. Before carrying out any repairs to cracks, it should be examined whether cracks have stabilized, that is, are not widening further. No useful purpose is served in repairing cracks when these are still developing. Cracks due to thermal movement generally recur when repaired with mortar; such cracks should be filled with some mastic compound.

9.6.2 Cracks up to 1.5 mm width generally need no repairing if bricks used are of absorbent type as is normally the case in India. In case of non-absorbent bricks, cracked joints should be raked out and refilled with 1 cement : 6 sand : 1 lime mortar. There is a possibility of rain water penetrating through thin cracks when bricks are of non-absorbent type and hence the need to repair even thin cracks in such cases. In case of cracks wider than 1.5 mm, these would generally need repairing, method of repairing depending on type of mortar used in the brickwork. With weak mortar, cracks should be enlarged and raked out to a depth of about 25 mm and refilled with 1 cement : 2 lime : 9 sand mortar and repainted or replastered (a 10-cm wide strip around the crack) as the case may be with the same mortar. When the affected wall is built in strong mortar, bricks adjoining the cracks should be cut out and replaced with new bricks, using 1 cement : 1 lime : 6 sand mortar. The same procedure should be followed when some bricks are cracked.

9.6.3 In case of wide diagonal cracks which would generally occur due to settlement of

foundation, if there is a possibility of further movement, repairs should be carried out by removing and replacing all cracked bricks, using RCC stitching blocks in every 5th or 6th course that is at about one-half metre spacing in the vertical direction (see Photo 12). RCC stitching blocks should be, in width equal to thickness of wall, in length equal to $1\frac{1}{2}$ to 2 bricks and in thickness equal to 1 or 2 bricks, depending upon the severity of cracking. It is not desirable to use a mortar stronger than 1 cement : 1 lime : 6 sand for these repairs.

9.7 RCC Members of a Structure

- a) **RANDOM OR MAP PATTERN CRACKS IN CONCRETE MEMBERS EXPOSED TO WEATHER OCCURRING MANY YEARS AFTER CONSTRUCTION (15 TO 25 YEARS) AND PROGRESSING VERY SLOWLY—** These cracks are likely to be due to shrinkage caused by carbonation of concrete. If concrete used is quite sound and dense, these cracks would not have much depth and, therefore, may not be of much consequence. If, however, concrete used is not very dense, in course of time, as carbonation progresses, reinforcement may get corroded. This has been discussed later in 9.7(b).
- b) **STRAIGHT CRACKS IN CONCRETE COLUMNS, BEAMS AND SLABS PARALLEL TO REINFORCEMENT ACCOMPANIED BY SPALLING OF COVER AND EXPOSURE OF REINFORCEMENT AT PLACES, CRACKING HAVING OCCURRED 10 TO 25 YEARS AFTER CONSTRUCTION—** Reinforcement, wherever it has become exposed is found to be rusted. These cracks are due to corrosion of reinforcement and would occur if concrete in question is not sufficiently dense and moisture from some source has been causing continuous dampness in the affected portion. Sometimes, when concrete is porous, carbonation proceeds at a rapid rate, penetrating the cover deep enough so as to reduce alkalinity of concrete and to cause rusting of reinforcement. Cracks in question, if rusting is not too severe, could be repaired by removing all loose and damaged concrete, cleaning reinforcement of all rust and re-concreting the affected area by guniting (that is depositing concrete under pneumatic pressure).
- c) **STRAIGHT CRACKS IN RCC SUNSHADES ACROSS THE LENGTH OCCURRING AT REGULAR INTERVALS OF 3 TO 5m AND ALSO AT CHANGES IN DIRECTION—** These cracks are due to drying shrinkage of concrete combined with thermal contraction. Cracks are more prominent in winter. These cracks would occur when proper control/expansion joints have not been provided. Jobs executed in summer months are more prone to such cracks and there is no effective remedy for these cracks. Sometimes, it may be feasible to introduce control joints at cracked sections by sawing across the section.
- d) **STRAIGHT CRACKS IN LONG RCC BALCONIES ACROSS THEIR LENGTH—** These are similar to those occurring in sunshades as discussed in 9.7(c) and the cause is also the same, the main difference



Photo 12 Diagonal crack in the corner of a building due to foundation settlement; crack has been repaired by providing RCC stitching blocks

being that the spacing of cracks in balconies is somewhat more than those in sunshades.

- e) **STRAIGHT CRACKS IN RCC SLAB OF LONG OPEN VERANDAHS OCCURRING AT REGULAR INTERVALS OF 6 TO 8m APART PARALLEL TO MAIN REINFORCEMENTS**—These cracks are due to drying shrinkage combined with thermal contraction. Cracks will be widest in winter and may partially close during summer. Jobs carried out in hot summer will be more prone to such cracks. These cracks occur if expansion joints have not been provided at the construction stage. If cracks are very conspicuous, these could be made less unsightly by cutting straight deep grooves in the slab at the bottom thus converting the cracks into movement joints. If flooring on the top is also cracked as would generally happen, portion of the floor should be relaid with a straight joint corresponding to the position of the groove at the bottom so as to allow for movement, filling the crack in slab with some mastic compound.

9.8 Reinforced Brickwork in Slabs—Cracks first begin to appear at the bottom surface in the plaster corresponding to the position of the reinforcement in about 10 to 25 years, depending upon a number of factors, such as quality of bricks used in reinforced brickwork, quality of mortar/concrete surrounding the reinforcement, adequacy of cover to the reinforcement, presence of soluble salts in the bricks, extent of dampness to which the job is subjected to, etc. After some time, cracks widen and spalling of plaster and bricks takes place exposing the reinforcement at places. Sometime large chunks of plaster along with some portion of bricks below the reinforcement fall down. There is no effective remedy against these cracks. However, further deterioration could be slowed down by improving roof drainage and plugging sources of water leakage, if any. In case, however, section of reinforcement is reduced so much as to render the slab structurally unsafe, the slab has to be replaced. Since presence of moisture for corrosion of reinforcement is obligatory, roof slabs and also floor slabs in wet locations, namely, baths, water closets and kitchens, are more prone to the type of cracking in question. Brick walls exposed to weather should not be reinforced unless reinforcement is provided with good quality concrete or cement mortar cover of adequate thickness.

9.9 Rendering and Plastering

- a) **RENDERING OR PLASTER ON MASONRY BACKGROUND**—It should be examined if

necessary, by removal of small portion of the plaster, whether these are surface cracks or these extend to the background also. In the latter case, it is necessary to investigate the cracks in the background material as discussed earlier in this section. If these are surface cracks, these could be due to shrinkage because of use of rich mortar, inadequate curing or lack of bond with the background or sulphate attack. Shrinkage cracks occur during the first dry spell after construction. Cracks due to lack of bond could be identified by tapping the affected portion which will emit a hollow sound. Cracks due to sulphate action would appear 2 or 3 years after completion of the job if the affected portion had remained damp for long spells, either due to rain or due to leakage of water from some other source. These cracks will start as thin horizontal cracks in the mortar joint and will slowly go on extending in size and length. Also, in this case, mortar will be found to have weakened in strength.

Shrinkage cracks would generally be thin and could be left unattended up to the normal time for renewal of finishing coat when these will get filled up. To repair cracks due to lack of bond, affected portion of plaster should be removed, joints in masonry raked to a depth of about 10 mm and replastering done taking all precautions as required for a good plaster job. If cause of cracking is found to be due to sulphate attack, source of dampness should be plugged, if feasible. If mortar has become weak and unserviceable, the affected portion should be replastered using sulphate resistant cement after removing all old mortar and raking joints in masonry.

- b) **RENDERING OR PLASTERING ON CONCRETE BACKGROUND**—In this case, crazing or cracking may occur either due to shrinkage or due to heavy stress in the member. Shrinkage cracks occur if mortar used is too rich or wet, if curing has been inadequate, if sand used is too fine and if rendering/plastering is done long after casting of concrete. Rendered/plastered surfaces are not likely to crack if live load is small as compared to dead load. Fluctuating stresses, however, as in crane gantries are likely to cause cracks in rendering/plastering.

- c) **CRACKS AROUND DOOR FRAMES**—These cracks occur, firstly due to shrinkage of wood frames, cracks being quite conspicuous if wood used in frames is not properly seasoned [see SI No. (7) of

of Table 2] and frames are fitted flush with wall, and secondly due to a slack between the holdfasts and the frames. When holdfasts are not properly fixed to the frames, heavy vibrations due to repeated opening and closing of doors are transmitted to masonry and plaster, resulting in cracks in masonry and plaster around the frame. Cracking due to first cause can be concealed with the help of architraves and do not present much of a problem. For cracking due to second cause, the only satisfactory remedy is to dismantle the masonry so as to remove the frame and to refix the same after securely fastening the holdfasts to the frame. When doors are provided in half-brick masonry walls, holdfasts should be at least 25 cm in length and should be embedded in 1 : 2 : 4 concrete, 2-brick courses in height and $1\frac{1}{2}$ brick in length.

9.10 Concrete/Terrazo Floors and Concrete Pavements

- a) **CRAZING**—Concrete/terrazo floors and concrete pavements are normally provided with control/expansion joints to take care of drying shrinkage and thermal movement. In spite of these precautions, sometimes the floors/pavements develop very fine cracks of map pattern known as crazing. These cracks appear soon after construction and are due to use of excessive water in the concrete/terrazo mix, poor grading of aggregates, quick drying after laying, or inadequate curing. There is no effective remedy for such cracks once these appear, the affected portion has to be replaced when it becomes unserviceable.
- b) **CORNER CRACKS**—Corner cracks in panels of concrete flooring occur because of curling up of corners due to differential

shrinkage between the top and bottom of the slab. When load comes on the floor, curled up corners give way and develop cracks due to tension on the top. These cracks are shown in Fig. 58. Differential shrinkage in floor panels occurs due to use of excessive water in concrete or excessive trowelling, and fine working up to the top during the process of tamping and trowelling. There is no effective remedy against such cracking; the affected portion when it becomes unserviceable has to be replaced.

- c) **RANDOM CRACKS IN FLOORING OF GROUND FLOOR ACCOMPANIED BY LIFTING AND ARCHING UP**—These cracks generally appear 2 or 3 years after laying when brick ballast has been used as aggregate in the base concrete below the floor and moisture from some source finds access to the base concrete, keeping it damp for long spells. Such cracking is likely to be due to sulphate action because of presence of soluble sulphates in brick ballast. This diagnosis should be confirmed through proper tests. There is no effective remedy against these cracks and affected portion has to be replaced when it becomes unserviceable, taking all precautions against sulphate attack when re-doing the work.
- d) **RANDOM CRACKS IN FLOORING OF GROUND FLOOR AND PAVEMENTS ACCOMPANIED BY SUBSIDENCE AND TILTING OF PANELS**—These occur due to settlement of soil if there is a deep fill under the floor and compaction of the fill has not been properly done. sometime such type of cracking occurs only when water from some source, for example, heavy rains or floods or a leaking water supply main finds access to the fill and causes subsidence. That may happen soon or long after the construction.

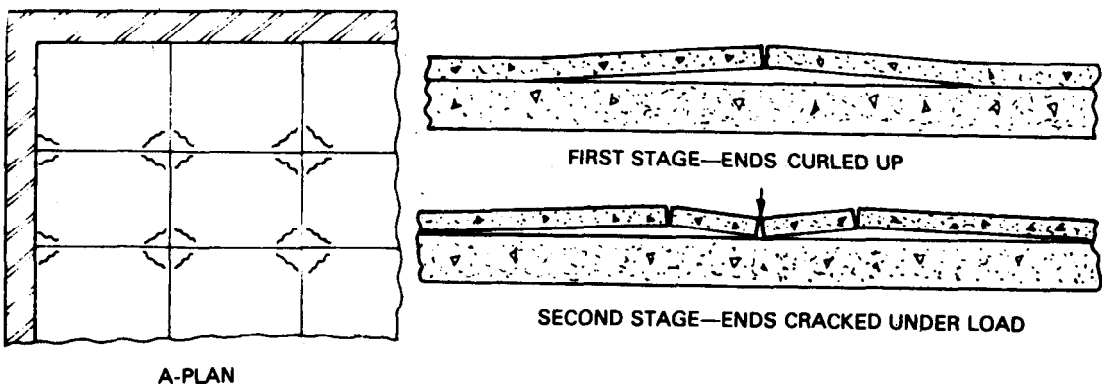

Fig. 58 Corner Cracks in Panels of Concrete Flooring

Damaged flooring should be relaid after ensuring proper compaction of the sub-base.

9.11 Roof Terrace—Cracks in roof terrace generally result in leakage of rain water through roof and are a matter of common occurrence since a terrace is very much exposed to weather. Cracking occurs along the parapets at the junction and also at intermediate sections in long stretches, the main causes of cracking being thermal and moisture movements. Remedial measures for these cracks are enlarging and cleaning the cracks and filling them with mastic compound so as to seal the cracks without hindering future movement. If these cracks are repaired with cement mortar, in course of time cracks would reappear and no useful purpose is served. Cracks at the junction of roof terrace and parapets could be avoided or minimized by adopting junction arrangement as shown in Fig.12.

9.12 Wood Work

a) **DOOR AND WINDOW FRAMES AND JOINERY**—Cracks in door and window frames and joinery are basically due to initial drying and these cracks could be very unsightly if unseasoned timber is used in construction. Since shrinkage in wood work in a direction normal to the length of the grain is quite substantial, there is no satisfactory remedy against opening out of joints and warping of wood work when unseasoned timber is used. For this reason, use of wide panels of plain wood in joinery is avoided and instead plywood panels are used in internal work that is not subject to wetting.

Cracks in wood-work could be filled up with good quality putty made by mixing paint and whiting and thereafter applying one or two coats of paint to check further moisture movement. These repairs should be carried out during dry weather and periodical renewal coats of paint should be applied as soon as they become due. Repairs to cracks in wood-work, however, generally do not prove very effective and it is necessary to avoid these cracks in the first instance by using seasoned timber, selecting right type of timber or timber product to suit the job and by applying protective coats to wood work so as to check moisture movement.

b) **CRACKS AT JUNCTION OF DOOR AND WINDOW FRAMES IN MASONRY**—This type of cracking has been discussed already in 9.9(c) and may be referred to.

9.13 Glass Panes and Panels of Glass Blocks

a) **CRACKING OF GLASS PANES IN WINDOWS**—This cracking could occur due to one or more of the following causes:

1) If rebates have not been evenly back puttied before fixing of glass panes in position and the panes have not been securely fixed, these may rattle due to wind pressure and may crack. Cracked glass panes should be replaced, applying back-putty on the entire length of rebate and bedding the glass solidly.

2) If glass panes are fixed without adequate and uniform clearance in the rebate all round, glass panes may crack due to thermal expansion, particularly if the glass pane happens to have no or very little clearance at one or more points. Such cracking sometime occurs in steel windows exposed to sun and rain because of rusting of steel and its consequent expansion, thermal expansion of steel and glass, and inadequate clearance between glass and steel at one or more points. Steel windows with large glass panes are more liable to such cracking. Remedy for such cracking lies in replacing the cracked panes, after thorough cleaning of rusted portion of steel and allowing adequate and uniform clearance between glass pane and steel all round (3 to 4 mm). To avoid recurrence of these cracks, steps should be taken to prevent rusting of steel and where feasible, sun-shading of the window should be improved.

b) **GLASS BLOCKS**—Cracks in panels of glass blocks take place when these are too much exposed to direct sun and there is no satisfactory provision for expansive movement of the blocks. To remedy such cracks, it should be ensured that there is adequate provision for expansion of glass blocks in both directions and if feasible, shading device, to prevent direct sun on the blocks, should be improved.

9.14 Asbestos Cement Sheets—Map pattern cracks in asbestos cement sheets occur because of shrinkage due to carbonation of hydration products of cement used in the manufacture of these sheets, since volume of the constituents after carbonation is reduced on drying. There is no remedy once cracking occurs. These cracks could, however, be prevented by giving protective coats of paint on both sides of the sheet. If protection is provided only on one side, sheets may warp due to carbonation of one face and consequent differential movement

SECTION 10 SUMMARY OF MEASURES FOR PREVENTION OF CRACKS IN STRUCTURES

10.1 General

10.1.1 As explained in earlier sections, the basic causes of cracking in structures are moisture change, thermal variation, stress, chemical action, foundation movement and vegetation. As measures for prevention of cracks are in many cases common to more than one cause, it has been thought necessary for convenience of reference to summarize all important measures in this Section; the measures having been dealt with in detail earlier.

10.1.2 Measures for prevention of cracks could be broadly classified under the following main sub-heads:

- a) Choice of materials;
- b) Specifications for mortar and concrete;
- c) Architectural design of buildings;
- d) Structural design;
- e) Foundation design;
- f) Construction practices and techniques; and
- g) Environments.

In the following paragraphs, important measures for prevention/minimization of cracks under the above broad scheme of classification have been summarized.

10.2 Choice of Materials

10.2.1 Certain properties of building materials have very vital influence on cracking which occur during construction or after the structure is completed and it is necessary for the engineer/architect to have proper knowledge and understanding of these properties so that either use of such materials as may result in cracking could be avoided, if possible, or when use of such materials is inevitable, suitable precautions as would help in minimizing cracks could be taken. Properties of materials that influence cracking are: drying shrinkage, moisture movement, thermal expansion, modulus of elasticity, porosity, creep, thermal conductivity, thermal insulation, thermal capacity, reflectivity and chemical composition.

10.2.2 MASONRY UNITS

- a) Burnt clay bricks and other burnt clay products should not be used in masonry for a period of at least two weeks in summer and three weeks in winter after these have been unloaded from kilns. These should be kept exposed to atmosphere during this period (see 2.4.4).

- b) For use in masonry, bricks should be well burnt [Sl No. (1) of Table 2].
- c) Use of burnt clay bricks containing excessive quantity of soluble sulphates should be avoided; if their use cannot be avoided, suitable precautions against sulphate attack should be taken. [see 6.2.7 (b)].
- d) When using units, having high values of drying shrinkage, for example, concrete blocks and sand-lime bricks, precautions as mentioned in 2.5.10 [Sl No. (4) of Table 2] should be taken.
- e) For masonry work, use of such stones as are porous and are liable to shrink on drying, for example, sandstones, should be avoided [see 2.5.10 and Sl No. (2) of Table 2].

10.2.3 FINE AGGREGATES

- a) Use of fine aggregate for mortar and concrete which is too fine or contains too much of clay or silt and is not well graded should be avoided. Percentage of clay and silt in fine aggregate (uncrushed) should not exceed 3 percent [see 2.3.3 (c) and 2.3.3(f)].

10.2.4 COARSE AGGREGATES

- a) Coarse aggregate for concrete work should be well graded so as to obtain concrete of high density [see 2.3.3 (c)].
- b) Maximum size of coarse aggregate should be largest possible consistent with the job requirements [see 2.3.3 (c)].
- c) Coarse aggregate for concrete should not be of stones that are porous and have high shrinkage coefficient [see 2.3.3(c)].
- d) Use of aggregate made from alkali-reactive stone should be avoided. If it is not possible to avoid the use of such aggregate, precautions as mentioned in 6.5.2 should be taken.
- e) When using brick aggregate for concrete in base course, use of aggregate containing excessive amount of soluble sulphates should be avoided (see 6.2.5).
- f) Coarse aggregates should not contain fines exceeding 3 percent [see 2.3.3(f)].

10.2.5 CEMENT

- a) When use of alkali-reactive aggregate in concrete is unavoidable, alkali content of cement should not exceed 0.6 percent. If low-alkali cement is not economically available, use of pozzolanas should be made to check alkali-aggregate reaction (see 6.5.2).

- b) When use of bricks containing excessive quantity of soluble sulphates is unavoidable, content of cement in mortar should be increased or special cements, namely, sulphate resisting portland cement or super-sulphated cement should be used (*see 6.2.7*).
- c) In massive structures, in order to limit heat of hydration, use of low-heat cement should be made unless other methods are adopted to prevent rise in temperature of concrete [*see 3.5(d)*].

10.2.6 TIMBER AND TIMBER PRODUCTS

- a) Use of unseasoned timber in wood-work and joinery should be avoided [*see 2.5.10 and SI No. (8) of Table 2*].
- b) In large panels of joinery (say larger than 25 cm in width) use should be made of plywood or blockboard panels in place of plain wood panels for internal work as the former have better dimensional stability [*see 2.5.9 and SI No. (7) of Table 2*].

10.2.7 CALCIUM CHLORIDE

- a) Use of calcium chloride in concrete as accelerator should be avoided, as far as possible. If unavoidable, its quantity should be limited to 2 percent of cement content. [*see 2.3.3(d) and 6.4.3(g)*].

10.2.8 GYPSUM — Gypsum plaster (CaSO_4) should not be used for external work or internal work in locations which are likely to get or remain wet. It should be borne in mind that gypsum and Portland cement are incompatible, since in the presence of moisture, a harmful chemical reaction takes place [*see 6.2.7(c)*].

10.2.9 WOOD WOOL — When using wood-wool slabs in partitions, etc, moisture movement should be concealed by providing cover strips at joints and surrounds [*see 2.5.10 and SI No. (5) of Table 2*].

10.2.10 STEEL REINFORCEMENT — Use of steel as reinforcement in brick masonry in exposed situations should be avoided unless special precautions are taken to prevent rusting (*see 6.4.5*).

10.3 Specifications for Mortar and Concrete

10.3.1 Components or items in a building which are most prone to cracking are walls, floors, plasters and concrete work. Therefore, specifications of mortar and concrete have a very important role to play in regard to the incidence of cracking in buildings. Apart from strength and durability, specifications for mortar and concrete should be decided on consideration of obtaining products with

minimum of drying shrinkage and creep and with adequate resistance against sulphate attack. Some of the important considerations for deciding specifications of mortar and concrete are given below.

10.3.2 MORTAR

a) MORTAR FOR MASONRY WORK

- 1) Use of rich cement mortars which have high shrinkage should be avoided; composite cement-lime mortar should be preferred (*see 2.5.2*).
- 2) When using concrete blocks of dense or light weight concrete or sand-lime bricks as masonry units in non-load bearing walls, use of rich cement mortars should be avoided. Mortar 1 cement : 2 lime : 9 sand for work done in summer and 1 cement : 1 lime : 6 sand for work done in winter would be adequate in most of the cases [*see 2.5.10 and SI No. (4) of Table 2*].

b) MORTAR FOR PLASTER WORK — Use of rich cement plasters for plaster work should be avoided; composite cement-lime mortars are less liable to shrinkage cracks; also plaster using mortar with coarse sand will crack less (*see 2.5.6*).

10.3.3 CEMENT CONCRETE

- a) Mix should not be richer than what is required from strength consideration. Aim should be to obtain strong and durable concrete by careful mix design, grading of aggregates, control of water cement ratio, thorough mixing, proper compaction and adequate curing, etc. An over-sanded mix should be avoided (*see 2.3.3*).
- b) Quantity of water used in concrete should be the minimum, consistent with requirements for laying and proper compaction. This is one of the most important single factor which influences shrinkage and consequent cracking in concrete [*see 2.3.3 (b)*].

10.4 *Architectural Design of Buildings* — Factors relating to architectural design of buildings which affect cracking are: large spans of rooms, provision of large windows in external walls, introduction of short return walls in external elevation, etc. Door and window frames should not be placed flush with plaster surface and if that is unavoidable, either the joints should be concealed with moulding strips or arrangement shown in Fig. 10 followed [*see SI No. (7) of Table 2 and 4.3 and 4.4*].

10.5 Structural Design of Buildings— Factors in structural design which have an influence on cracking are:

- a) Stress in different parts of masonry walls should be more or less uniform so as to avoid differential strain and consequent shear stresses and cracking (*see 4.1*).
- b) Flexural members, namely, slabs and beams should have adequate stiffness so as to limit deflection (*see 4.1*).
- c) Flexural cracks in concrete should be limited in width to 0.30 mm for protected internal members and 0.20 mm for unprotected external members [*see 6.4.3(a)*].
- d) In a rigid structure, such as rigid frames and shells, since movement joints are not feasible, thermal and shrinkage stresses should be taken care of in the design [*see 3.10(a)*].

10.6 Structural Design of Foundation

- a) Bearing pressure on foundation soil should be more or less uniform so as to avoid differential settlement (*see 7.1*).
- b) Value of safe bearing pressure assumed for foundation design should be such as would keep overall settlement within reasonable limits for the type of structure in question (*see 7.1*).
- c) When building on soil consisting of shrinkable clays, soil movements due to alternate wetting and drying and consequent swelling and shrinkage should be taken care of by providing special foundations, such as under-reamed piles, to avoid cracking. Also when necessary, water-proof apron should be provided all round the building to minimize moisture changes in soil under the building [*see 7.2 and 9.5.1(n)*].

10.7 Construction Practices and Techniques

10.7.1 MOVEMENT JOINTS— Movement joints should be provided in structures in accordance with the provisions of 3.11 and guidelines suggested in Table 5.

10.7.2 FILLING IN PLINTH— Filling of soil in plinth should be done with good soil free from organic matter, brick-bats, and debris, etc. It should be laid in 25 cm thick layers, well watered and compacted so that there may be no possibility of subsequent subsidence and cracking of floors. Special precautions are needed if filling is deep or flooring has to bear heavy loads as in grain, godowns, warehouses and factory buildings (*see 7.8*).

10.7.3 MASONRY WORK

- a) Masonry work should proceed at a uniform level all round so as to avoid differential loading on the foundation. Mortar for masonry should not contain excessive water. Curing for masonry work should be done for a minimum period of 7 to 10 days [*see 7.7, 2.3.3(b) and (e)*].
- b) Masonry work on RCC slabs and beams should not be started till at least 2 weeks have elapsed after striking of centering [*see 4.6 and 5.10(a) (iii)*].

10.7.4 CONCRETE WORK

- a) Whenever feasible, concrete should be compacted by vibration so as to enable use of low-slump concrete [*see 2.3.3(b)*].
- b) As far as possible, concreting job should not be done when it is very hot, dry and windy. If unavoidable, precautions should be taken to keep down temperature of fresh concrete and to prevent quick drying [*see 2.3.3 (c)*].
- c) Curing should be done for a minimum period of 7 to 10 days. It should be terminated gradually so as to avoid quick drying [*see 2.3.3 (e) and 5.6*].
- d) In case of RCC members which are liable to large deflection under load, for example, cantilevered beams and slabs, removal of centering and imposition of load should be deferred as much as possible so that concrete attains sufficient strength [*see 5.10.1(a) (vi)*].
- e) Water for mixing and curing of concrete should not contain impurities in excess of permissible limits [*see 6.4.3(n)*].

10.7.5 RCC FRAMED CONSTRUCTION

- a) As far as possible, frame work should be completed before starting work of panel walls for cladding and partition walls. Work of construction of panel walls and partitions should be deferred as much as possible and it should be proceeded with from top downward [*see 5.10(b)*].
- b) Horizontal movement joints should be provided between top of panel walls and soffit of beam, and when structurally necessary, lateral support to the walls should be provided at top by using telescopic anchorages or similar restraints [*see 5.10(b)*].
- c) When partition walls are to be supported on floor slab or beam, upward camber in the slab/beam should be provided to forestall deflection [*see 5.10(c)*].

- d) A horizontal expansion joint should be provided between top of a partition wall and soffit of slab/beam, filling the gap with some compressible jointing material [see 5.10(c)].
- e) If a door opening is to be provided in a partition wall, a central opening should be preferred to an off-centre opening [see 5.10(c)].
- f) Plaster work on panels and partitions should be deferred as much as possible [see 5.10(a)].

10.7.6 PLASTERING

- a) When plastering on masonry background, mortar joints in masonry should be raked while the mortar is green. Plastering work should be done after masonry has been properly cured and allowed to dry so as to undergo initial shrinkage before taking up plaster work [see 2.5.6 and SI No. (1) of Table 2]
- b) When plastering on concrete background, plastering should be done as soon as feasible after hacking and roughening the surface and applying cement slurry on the concrete surface to improve bond (see 2.5.6).
- c) When RCC work and masonry abut each other, plaster work should be deferred as much as possible [see 5.10(a)].

10.7.7 CONCRETE AND TERRAZO FLOORS

- a) Control joints should be provided in concrete and terrazo floors either by laying floors in alternate panels or by interposing dividing strips (see 2.5.4).
- b) When flooring is to be laid on RCC slabs, either a base course of lime-concrete should be provided between the RCC slab and the flooring or surface of slab should be well roughened, cleaned and primed with cement slurry before laying the concrete/terrazo floors [SI No.6(j) of Table 5].

10.7.8 RCC LINTELS—Bearing for RCC lintels should be rather on the liberal side when spans are large so as to avoid concentration of stress at the jambs.

10.7.9 CONCRETE PAVEMENTS—Control and expansion joints should be provided as recommended [SI. No. (5) of Table 5].

10.7.10 FINISH ON WALLS—Items of finish on walls, namely, distemper, and painting, etc, should be carried out after the plaster has

completely dried and undergone drying shrinkage [SI. No. 6(k) of Table 5].

10.7.11 RCC WORK IN EXPOSED SITUATIONS—RCC work in exposed situations, namely, sunshades, balconies, canopies, open verandahs, etc, should be provided with adequate quantities of temperature reinforcement so as to prevent shrinkage-cum-contraction cracks [see 3.10(b)].

10.7.12 PROVISION OF GLAZED, TERRAZO OR MARBLE TILES TO VERTICAL SURFACES—When glazed, terrazo or marble tiles are to be bonded to vertical surfaces, it is necessary to allow movement of background due to elastic deformation, shrinkage and creep to take place before fixing of the tiles, otherwise tile work is likely to get dislodged and cracked (see 4.5).

10.7.13 CONCRETE WORK IN COASTAL AREAS AND MARINE STRUCTURES—It is essential that concrete work in coastal areas and marine structures which are likely to come in contact with sea water should be of very good quality and concrete shall be dense and impervious since sea water getting into pores of concrete would reduce the alkalinity of concrete and would cause rapid corrosion of reinforcement and cracking [see 6.4.3 (h)].

10.7.14 SULPHATE ATTACK—For foundation on soil containing excessive quantities of soluble sulphates or having ground water containing soluble sulphates, certain precautions are necessary to minimize damage due to sulphate action as given in 6.2.3.

10.7.15 PACE OF CONSTRUCTION—If pace of construction is too fast it can result in cracking. Firstly, all items of masonry should be properly cured and allowed to dry before plastering work is done [SI. No. (1) of Table 2]. This way shrinkage cracks in masonry will get concealed in plaster work. Secondly, all plaster work should be cured and allowed to dry before applying finishing coats. Thus, plaster will undergo unavoidable shrinkage before application of finish which would conceal the cracks in plaster work [SI. No. 6(k) of Table 5]. In case of concrete work, it is necessary that before construction of any masonry work either over it or by its side, most of drying shrinkage, creep and elastic deformation should be allowed to take place so as to avoid cracks in masonry or cracks at the junction of concrete and masonry. Creep in concrete depends upon age of concrete at the time of loading; delayed loading thus reduces creep. Construction schedules should therefore, be drawn and pace of construction regulated keeping these requirements in view and jobs should not be rushed through unnecessarily and unwittingly (see 5.10.1).

10.7.16 EXTENSION TO AN EXISTING BUILDING

- a) When making a horizontal extension to an existing building, a slip joint/expansion joint should be introduced between old and new work so that settlement of soil under the load of new portion may not cause cracks at the junction of the two [Sl. No.(3) of Table 5].
- b) When making vertical extension to an existing building (that is, adding one or more additional floors) work should proceed at a uniform level all round so as to avoid differential loading on the foundation. In spite of this precaution, however, sometimes cracks appear in the lower floors (old portions) at the junction of RCC columns carrying heavy loads and lightly loaded brick masonry due to increase in elastic deformation and creep in RCC columns. Such cracks cannot be avoided. Renewal of finishing coats on walls of old portion, however, should be deferred for 2 or 3 months after imposition of additional load due to new construction so that most of the likely cracking should take place before finish coat is applied, thus concealing the cracks (see 5.7 and 7.5).

10.7.17 USE OF PRECAST COMPONENTS— Judicious use of precast components can help to reduce incidence of cracking in structures since such components are pre-shrunk (see 2.5.4).

10.7.18 CONTROLLING HEAT OF HYDRATION—In massive concrete structures, heat of hydration of cement, if not properly taken care of, could lead to cracking. To prevent such cracks it is necessary to control heat of hydration by using low-heat cement or addition of pozzolanas in the concrete and either to pre-cool aggregates and mixing water or to cool the freshly laid concrete by circulating refrigerated water through pipes embedded in the body of the concrete [see 3.5(d)].

10.7.19 TREATMENT ON EXTERNAL WALLS WITH COMPOSITION RICH IN CEMENT— When it is proposed to give some treatment on external walls, rich in cement namely, artificial stone finish, terrazo, etc, the finish should be laid in small panels with deep grooves in both directions (see 2.5.7).

10.7.20 RCC ROOF SLAB— It is necessary to provide adequate thermal insulation or protective cover together with some high reflectivity finished on the top of insulating material or protective cover in order to check thermal movement of the slab and consequent cracks in supporting walls of a load-bearing structure or panel and partition walls of a framed-structure [see 3.5 (a) and 3.5(c)]. In case of load bearing structures, slab supports should permit unrestrained movement (see 3.11.4).

10.8 Environments

- a) **VEGETATION—** Following precautions are necessary in regard to growing or removal of trees in the close vicinity of structures:
 - 1) When a building is founded on shrinkable soil, trees, particularly fast growing trees, should not be grown within a distance of expected height of trees [see 8.5(a)].
 - 2) If old trees exist close to an old building (within a distance of the height of the tree) these trees should not be removed all at once in one operation. If removal of trees is unavoidable, it should be done in stages [see 8.5(b)].
 - 3) When a site having shrinkable soil has been newly prepared for construction of buildings by clearing off existing trees and vegetation, construction work should not be started till the soil which had been desiccated by tree roots, has normalized in regard to its moisture content [see 8.5(c)].
- b) **AMBIENT TEMPERATURE—** Concrete work done in hot weather is highly crack-prone due to high shrinkage. It is, therefore, desirable to avoid concreting when ambient temperature is high or to take some special precautions [see 2.3.3(j)].
- c) **DRY WEATHER—** Concreting done in dry weather is likely to get dried quickly after laying, which would result in plastic cracking. It is, therefore, necessary to take suitable precautions to prevent quick drying. If windy conditions prevail and ambient temperature is high, damaging effect will be much more severe [see 2.3.3(g) and 2.3.4].

A P P E N D I X A

(Clauses 9.1 and 9.3)

MONITORING AND MEASURING
MOVEMENT OF CRACKS

A-1 It is sometimes necessary to find out whether cracks which have occurred are still on the increase and if so to what extent? A commonly used method of doing so is to fix tell-tales consisting of strips of glass about 2 to 3 cm in width and 10 to 12 cm in length across a crack with some quick setting mortar or adhesive as shown in Fig. 59.

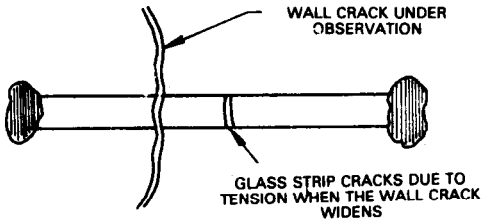

Fig. 59 Glass Tell-Tale for Observing Movements of Cracks in Walls, etc

If the crack widens, the tell-tale will crack. In case the crack closes instead of widening out, the glass strip will either get disjointed at one end or will crack by buckling.

A-2 When it is thought necessary to observe the rate of widening of a crack and to

measure the extent of widening in relation to time, instead of one glass strip, two glass strips are used side by side fixing them to the background only on one side at opposite ends as shown in Fig. 60.

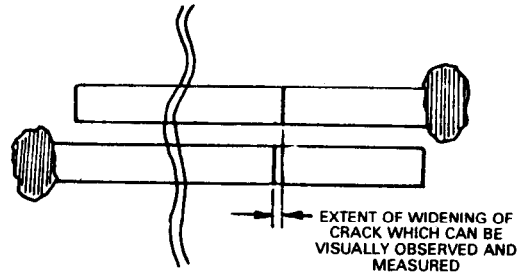

Fig. 60 Glass Tell-Tale for Measuring Extent of Movements of Cracks in Walls, etc

A line is drawn across the two glass strips after fixing, and as and when any widening or narrowing of the crack takes place, lines on the two strips move relatively to each other and distance between them at any time could be measured which would indicate the extent of movement up to the time of making the observation.

BIBLIOGRAPHY

Numbers given above any word in the text are serial numbers of reference listed below:

- 1) ACI manual of concrete practice, Part I, 1976. American Concrete Institute.
- 2) Building foundations in shrinkable soils (*First Report*), 1958. National Building Organization.
- 3) Calcium silicate brickwork, British Research Establishment Digest-157.
- 4) Concrete in sulphate-bearing soils and groundwaters. British Research Establishment Digest-174.
- 5) Control of cracking in concrete structures. Report of ACI Committee 224. ACI Journal, 1972
- 6) Cracking in buildings. British Research Establishment Digest-75.
- 7) CP 121:Part I:1973 Code of practice for walling. British Standards Institution.
- 8) Corrosion of RC and PC structures. Indian National Group of IABSE, Seminar at Madras, 1979.
- 9) Corrosion of reinforcement in concrete. A state of art report by 12-CRC Committee, Materials and structures, May-June, 1976.
- 10) IS:3414-1968 Design and installation of joints in buildings. Indian Standards Institution.
- 11) ELDRIDGE (HJ). Common defects in buildings 1976. Her Majesty's Stationery Office, London.
- 12) GRIM CLAYFORD (T). Design for differential movement in brick walls. Journal of Structural Division, November, 1975. Proceedings of American Society of Civil Engineers.
- 13) HALDENE DAVID. The Importance of cracking 1976. Performance of Building Structures. Pentech Press.
- 14) HANDISYDE (CC) and HASELTINE (BA). Bricks and brickwork 1974. The Brick Development Association, London.
- 15) JAI KRISHNA & JAIN (OP). Plain and reinforced concrete, 1968, Vol. II, Nem Chand and Bros., Roorkee.
- 16) LENCZNER (D), Movements in buildings 1973. Pergamon Press, Oxford.
- 17) Principles of modern building, 1961, Vol. I. Her Majesty's Stationery Office, London.
- 18) Principles of modern building, 1961, Vol. II. Her Majesty's Stationery Office, London.
- 19) IS:456-1978 Code of practice for plain and reinforced concrete (*third revision*). Indian Standards Institution.
- 20) Planning and design of tall building, 1972, Vol. III. Proceedings of International Conference held at Lehigh University.
- 21) Protection against corrosion of reinforcing steel in concrete. British Research Establishment Digest-59.
- 22) Remedial measures for cracked buildings in expansive soil areas. Building Digest No. 91, CBRI, Roorkee.
- 23) RAMESH (CK) and DATTA (TK) Cracking in reinforced concrete. Indian Journal, September 1974.
- 24) REYNOLDS, CHARLES (E). Concrete construction. Concrete Publication Limited, London.
- 25) Repairing brickwork. British Research Establishment Digest-200.
- 26) SAHLIN, SVEN. Structural masonry. Prentice-Hall Inc., New Jersey, 1971.
- 27) SIBMAC proceedings. The British Ceramic Research Association, 1971.
- 28) SHARMA (HD) and PANT (CM). Cracking in concrete structures. Cement and Concrete Journal, October 1960.
- 29) SELNA, LAWRENCE (G). Creep cracking and shrinkage in concrete frame structures. Journal of the Structural Division. Proceedings of American Society of Civil Engineers, September 1969.
- 30) SURESH CHAND. Cracks in buildings and their remedial measures. Indian Concrete Journal, October 1979.
- 31) Shrinkage of natural aggregates in concrete. British Research Establishment Digest-35.
- 32) Sulphate attack on brickwork. British Research Establishment Digest-89.
- 33) Sand-lime bricks, building materials Note No. 8. Central Building Research Institute, Roorkee.
- 34) IS:383-1970 Specification for coarse and fine aggregates from natural sources for concrete (*second revision*). Indian Standards Institution.
- 35) THOMAS (A). Moistures expansion in brickwork. Transactions and Journal of the British Ceramic Society, Vol. 70, No. 1, 1971.

- 36) THOMAS, KANNATH. The performance of high rise masonry structures. Performance of Buildings Structures, 1976. Pentech Press.
- 37) Thermal movements and expansion joints in buildings. Technical Information Series-15, 1960. National Building Organization.
- 38) The Selection of clay building bricks. Building Research Station Digest No. 25, December 1950.
- 39) The Cracking of absestos cement sheets. British Research Station Digest No. 130, 1960.
- 40) The avoidance of cracking in masonry construction of concrete or sand-lime bricks. British Research Station Digest No. 6 (*Revised*), 1957.
- 41) WADDELL JOSEPH (J). Concrete Construction Handbook 1974. Mc Graw-Hill Construction Company.