

इंटरनेट

मानक

### Disclosure to Promote the Right To Information

Whereas the Parliament of India has set out to provide a practical regime of right to information for citizens to secure access to information under the control of public authorities, in order to promote transparency and accountability in the working of every public authority, and whereas the attached publication of the Bureau of Indian Standards is of particular interest to the public, particularly disadvantaged communities and those engaged in the pursuit of education and knowledge, the attached public safety standard is made available to promote the timely dissemination of this information in an accurate manner to the public.

“जानने का अधिकार, जीने का अधिकार”

Mazdoor Kisan Shakti Sangathan

“The Right to Information, The Right to Live”

“पुराने को छोड़ नये के तरफ”

Jawaharlal Nehru

“Step Out From the Old to the New”

SP 16 (1980): Design Aids for Reinforced Concrete to IS 456:1978 [CED 2: Cement and Concrete]



“ज्ञान से एक नये भारत का निर्माण”

Satyanarayan Gangaram Pitroda

“Invent a New India Using Knowledge”



“ज्ञान एक ऐसा खजाना है जो कभी चुराया नहीं जा सकता है”

Bhartrhari—Nitiśatakam

“Knowledge is such a treasure which cannot be stolen”



BLANK PAGE



# Design Aids For Reinforced Concrete to IS : 456-1978



BUREAU OF INDIAN STANDARDS



**DESIGN AIDS  
FOR  
REINFORCED CONCRETE  
TO IS : 456-1978**

As in the Original Standard, this Page is Intentionally Left Blank

**Design Aids**  
**For Reinforced Concrete**  
**to IS : 456-1978**

**SP 16 : 1980**

FIRST PUBLISHED SEPTEMBER 1980

ELEVENTH REPRINT MARCH 1999

(Incorporating Amendment No. 1)

© BUREAU OF INDIAN STANDARDS

UDC 624.012.45.04 (026)

**PRICE Rs. 500.00**

PRINTED IN INDIA AT  
VIBA PRESS PVT. LTD., 122 DSIDC SHEDS, OKHLA INDUSTRIAL AREA, PHASE-I, NEW DELHI 110020  
AND PUBLISHED BY  
BUREAU OF INDIAN STANDARDS, NEW DELHI 110002

# FOREWORD

Users of various civil engineering codes have been feeling the need for explanatory handbooks and other compilations based on Indian Standards. The need has been further emphasized in view of the publication of the National Building Code of India 1970 and its implementation. In 1972, the Department of Science and Technology set up an Expert Group on Housing and Construction Technology under the Chairmanship of Maj-Gen Harkirat Singh. This Group carried out in-depth studies in various areas of civil engineering and construction practices. During the preparation of the Fifth Five Year Plan in 1975, the Group was assigned the task of producing a Science and Technology plan for research, development and extension work in the sector of housing and construction technology. One of the items of this plan was the production of design handbooks, explanatory handbooks and design aids based on the National Building Code and various Indian Standards and other activities in the promotion of National Building Code. The Expert Group gave high priority to this item and on the recommendation of the Department of Science and Technology the Planning Commission approved the following two projects which were assigned to the Indian Standards Institution:

- a) Development programme on Code implementation for building and civil engineering construction, and
- b) Typification for industrial buildings.

A Special Committee for Implementation of Science and Technology Projects (SCIP) consisting of experts connected with different aspects (*see* page viii) was set up in 1974 to advise the ISI Directorate General in identification and for guiding the development of the work under the Chairmanship of Maj-Gen Harkirat Singh, Retired Engineer-in-Chief, Army Headquarters and formerly Adviser (Construction) Planning Commission, Government of India. The Committee has so far identified subjects for several explanatory handbooks/compilations covering appropriate Indian Standards/Codes/Specifications which include the following:

Functional Requirements of Buildings  
Functional Requirements of Industrial Buildings  
Summaries of Indian Standards for Building Materials  
Building Construction Practices  
Foundation of Buildings  
Explanatory Handbook on Earthquake Resistant Design and Construction (IS : 1893  
IS : 4326)  
Design Aids for Reinforced Concrete to IS : 456-1978  
Explanatory Handbook on Masonry Code  
Commentary on Concrete Code ( IS : 456 )  
Concrete Mixes  
Concrete Reinforcement  
Form Work  
Timber Engineering  
Steel Code ( IS : 800 )  
Loading Code  
Fire Safety  
Prefabrication  
Tall Buildings  
Design of Industrial Steel Structures  
Inspection of Different Items of Building Work  
Bulk Storage Structures in Steel  
Bulk Storage Structures in Concrete  
Liquid Retaining Structures



**Construction Safety Practices  
Commentaries on Finalized Building Bye-laws  
Concrete Industrial Structures**

One of the explanatory handbooks identified is on IS : 456-1978 Code of practice for plain and reinforced concrete (*third revision*). This explanatory handbook which is under preparation would cover the basis/source of each clause; the interpretation of the clause and worked out examples to illustrate the application of the clauses. However, it was felt that some design aids would be of help in designing as a supplement to the explanatory handbook. The objective of these design aids is to reduce design time in the use of certain clauses in the Code for the design of beams, slabs and columns in general building structures.

For the preparation of the design aids a detailed examination of the following handbooks was made :

- a) CP : 110 : Part 2 : 1972 Code of practice for the structural use of concrete : Part 2 Design charts for singly reinforced beams, doubly reinforced beams and rectangular columns. British Standards Institution.
- b) ACI Publication SP-17(73) Design Handbook in accordance with the strength design methods of ACI 318-71, Volume 1 (Second Edition). 1973. American Concrete Institute.
- c) Reynolds (Charles E) and Steadman (James C). Reinforced Concrete Designer's Handbook. 1974. Ed. 8. Cement and Concrete Association, UK.
- d) Fintel (Mark), Ed. Handbook on Concrete Engineering. 1974. Published by Van Nostrand Reinhold Company, New York.

The charts and tables included in the design aids were selected after consultation with some users of the Code in India.

The design aids cover the following:

- a) Material Strength and Stress-Strain Relationships;
- b) Flexural Members ( Limit State Design );
- c) Compression Members ( Limit State Design );
- d) Shear and Torsion ( Limit State Design );
- e) Development Length and Anchorage ( Limit State Design );
- f) Working Stress Method;
- g) Deflection Calculation; and
- h) General Tables.

The format of these design aids is as follows:

- a) Assumptions regarding material strength;
- b) Explanation of the basis of preparation of individual sets of design aids as related to the appropriate clauses in the Code; and
- c) Worked example illustrating the use of the design aids.

Some important points to be noted in the use of the design aids are:

- a) The design units are entirely in SI units as per the provisions of IS : 456-1978.
- b) It is assumed that the user is well acquainted with the provisions of IS : 456-1978 before using these design aids.
- c) Notations as per IS : 456-1978 are maintained here as far as possible.
- d) Wherever the word 'Code' is used in this book, it refers to IS : 456-1978 Code of practice for plain and reinforced concrete (*third revision*).
- e) Both charts and tables are given for flexural members. The charts can be used conveniently for preliminary design and for final design where greater accuracy is needed, tables may be used.

- f) Design of columns is based on uniform distribution of steel on two faces or on four faces.
- g) Charts and tables for flexural members do not take into consideration crack control and are meant for strength calculations only. Detailing rules given in the Code should be followed for crack control.
- h) If the steel being used in the design has a strength which is slightly different from the one used in the Charts and Tables, the Chart or Table for the nearest value may be used and area of reinforcement thus obtained modified in proportion to the ratio of the strength of steels.
- j) In most of the charts and tables, colour identification is given on the right/left-hand corner along with other salient values to indicate the type of steel; in other charts/tables salient values have been given.

These design aids have been prepared on the basis of work done by Shri P. Padmanabhan, Officer on Special Duty, ISI. Shri B. R. Narayanappa, Assistant Director, ISI was also associated with the work. The draft Handbook was circulated for review to Central Public Works Department, New Delhi; Cement Research Institute of India, New Delhi; Metallurgical and Engineering Consultants (India) Limited, Ranchi, Central Building Research Institute, Roorkee; Structural Engineering Research Centre, Madras; M/s C. R. Narayana Rao, Madras; and Shri K. K. Nambiar, Madras and the views received have been taken into consideration while finalizing the Design Aids.

**SPECIAL COMMITTEE FOR IMPLEMENTATION OF SCIENCE AND  
TECHNOLOGY PROJECTS (SCIP)**

*Chairman*

**MAJ-GEN HARKIRAT SINGH**  
W-51 Greater Kailash I, New Delhi 110048

*Members*

**SHRI A. K. BANERJEE**

**PROF DINESH MOHAN**

**DR S. MAUDGAL**

**DR M. RAMAIAH**

**SHRI T. K. SARAN**

**SHRI T. S. VEDAGIRI**

**DR H. C. VISVESVARAYA**

**SHRI D. AJITHA SIMHA**

*(Member Secretary)*

**Metallurgical and Engineering Consultants (India) Limited,  
Ranchi**

**Central Building Research Institute, Roorkee**

**Department of Science and Technology, New Delhi**

**Structural Engineering Research Centre, Madras**

**Bureau of Public Enterprises, New Delhi**

**Central Public Works Department, New Delhi**

**Cement Research Institute of India, New Delhi**

**Indian Standards Institution, New Delhi**

# CONTENTS

	<i>Page</i>
<b>LIST OF TABLES IN THE EXPLANATORY TEXT</b> ... ..	<b>x</b>
<b>LIST OF CHARTS</b> ... ..	<b>xi</b>
<b>LIST OF TABLES</b> ... ..	<b>xiv</b>
<b>SYMBOLS</b> ... ..	<b>xvii</b>
<b>CONVERSION FACTORS</b> ... ..	<b>xix</b>
<b>1. MATERIAL STRENGTH AND STRESS-STRAIN RELATIONSHIPS</b> ... ..	<b>3</b>
1.1 Grades of Concrete .. ..	<b>3</b>
1.2 Types and Grades of Reinforcement ... ..	<b>3</b>
1.3 Stress-strain Relationship for Concrete ... ..	<b>4</b>
1.4 Stress-strain Relationship for Steel ... ..	<b>4</b>
<b>2. FLEXURAL MEMBERS</b> ... ..	<b>9</b>
2.1 Assumptions ... ..	<b>9</b>
2.2 Maximum Depth of Neutral Axis ... ..	<b>9</b>
2.3 Rectangular Sections ... ..	<b>9</b>
2.3.1 Under-Reinforced Sections ... ..	<b>10</b>
2.3.2 Doubly Reinforced Sections ... ..	<b>12</b>
2.4 T-Sections ... ..	<b>14</b>
2.5 Control of Deflection ... ..	<b>14</b>
<b>3. COMPRESSION MEMBERS</b> ... ..	<b>99</b>
3.1 Axially Loaded Compression Members ... ..	<b>99</b>
3.2 Combined Axial Load and Uniaxial Bending ... ..	<b>99</b>
3.2.1 Assumptions ... ..	<b>100</b>
3.2.2 Stress Block Parameters when the Neutral Axis Lies Outside the Section ... ..	<b>101</b>
3.2.3 Construction of Interaction Diagram ... ..	<b>101</b>
3.3 Compression Members Subject to Biaxial Bending ... ..	<b>104</b>
3.4 Slender Compression Members ... ..	<b>106</b>
<b>4. SHEAR AND TORSION</b> ... ..	<b>175</b>
4.1 Design Shear Strength of Concrete ... ..	<b>175</b>
4.2 Nominal Shear Stress ... ..	<b>175</b>
4.3 Shear Reinforcement ... ..	<b>175</b>
4.4 Torsion ... ..	<b>175</b>

		<i>Page</i>
5.	DEVELOPMENT LENGTH AND ANCHORAGE ...	183
5.1	Development Length of Bars ...	183
5.2	Anchorage Value of Hooks and Bends ...	183
6.	WORKING STRESS DESIGN ...	189
6.1	Flexural Members ...	189
6.1.1	Balanced Section ...	189
6.1.2	Under-Reinforced Section ...	189
6.1.3	Doubly Reinforced Section ...	190
6.2	Compression Members ...	190
6.3	Shear and Torsion ...	191
6.4	Development Length and Anchorage ...	191
7.	DEFLECTION CALCULATION ...	213
7.1	Effective Moment of Inertia ...	213
7.2	Shrinkage and Creep Deflections ...	213

## LIST OF TABLES IN THE EXPLANATORY TEXT

### Table

A	Salient Points on the Design Stress Strain Curve for Cold Worked Bars ...	6
B	Values of $\frac{x_{u,max}}{d}$ for Different Grades of Steel ...	9
C	Limiting Moment of Resistance and Reinforcement Index for Singly Reinforced Rectangular Sections ...	10
D	Limiting Moment of Resistance Factor $M_{u,lim}/bd^2$ , $N/mm^2$ for Singly Reinforced Rectangular Sections ...	10
E	Maximum Percentage of Tensile Reinforcement $P_{t,lim}$ for Singly Reinforced Rectangular Sections ...	10
F	Stress in Compression Reinforcement, $f_{sc}$ $N/mm^2$ in Doubly Reinforced Beams with Cold Worked Bars ...	13
G	Multiplying Factors for Use with Charts 19 and 20 ...	13
H	Stress Block Parameters When the Neutral Axis Lies Outside the Section ...	101
I	Additional Eccentricity for Slender Compression Members ...	106
J	Maximum Shear Stress $\tau_{c,max}$ ...	175
K	Moment of Resistance Factor $M/bd^2$ , $N/mm^2$ for Balanced Rectangular Section ...	189
L	Percentage of Tensile Reinforcement $p_{t,bal}$ for Singly Reinforced Balanced Section ...	189
M	Values of the Ratio $A_{sc}/A_{st2}$ ...	190



## LIST OF CHARTS

Chart  
No.

Page

### FLEXURE — Singly Reinforced Section

1	$f_{ck} = 15 \text{ N/mm}^2, f_y = 250 \text{ N/mm}^2$	$d = 5 \text{ to } 30 \text{ cm}$	...	17
2	$f_{ck} = 15 \text{ N/mm}^2, f_y = 250 \text{ N/mm}^2$	$d = 30 \text{ to } 55 \text{ cm}$	...	18
3	$f_{ck} = 15 \text{ N/mm}^2, f_y = 250 \text{ N/mm}^2$	$d = 55 \text{ to } 80 \text{ cm}$	...	19
4	$f_{ck} = 15 \text{ N/mm}^2, f_y = 415 \text{ N/mm}^2$	$d = 5 \text{ to } 30 \text{ cm}$	...	21
5	$f_{ck} = 15 \text{ N/mm}^2, f_y = 415 \text{ N/mm}^2$	$d = 30 \text{ to } 55 \text{ cm}$	...	22
6	$f_{ck} = 15 \text{ N/mm}^2, f_y = 415 \text{ N/mm}^2$	$d = 55 \text{ to } 80 \text{ cm}$	...	23
7	$f_{ck} = 15 \text{ N/mm}^2, f_y = 500 \text{ N/mm}^2$	$d = 5 \text{ to } 30 \text{ cm}$	...	25
8	$f_{ck} = 15 \text{ N/mm}^2, f_y = 500 \text{ N/mm}^2$	$d = 30 \text{ to } 55 \text{ cm}$	...	26
9	$f_{ck} = 15 \text{ N/mm}^2, f_y = 500 \text{ N/mm}^2$	$d = 55 \text{ to } 80 \text{ cm}$	...	27
10	$f_{ck} = 20 \text{ N/mm}^2, f_y = 250 \text{ N/mm}^2$	$d = 5 \text{ to } 30 \text{ cm}$	...	29
11	$f_{ck} = 20 \text{ N/mm}^2, f_y = 250 \text{ N/mm}^2$	$d = 30 \text{ to } 55 \text{ cm}$	...	30
12	$f_{ck} = 20 \text{ N/mm}^2, f_y = 250 \text{ N/mm}^2$	$d = 55 \text{ to } 80 \text{ cm}$	...	31
13	$f_{ck} = 20 \text{ N/mm}^2, f_y = 415 \text{ N/mm}^2$	$d = 5 \text{ to } 30 \text{ cm}$	...	33
14	$f_{ck} = 20 \text{ N/mm}^2, f_y = 415 \text{ N/mm}^2$	$d = 30 \text{ to } 55 \text{ cm}$	...	34
15	$f_{ck} = 20 \text{ N/mm}^2, f_y = 415 \text{ N/mm}^2$	$d = 55 \text{ to } 80 \text{ cm}$	...	35
16	$f_{ck} = 20 \text{ N/mm}^2, f_y = 500 \text{ N/mm}^2$	$d = 5 \text{ to } 30 \text{ cm}$	...	37
17	$f_{ck} = 20 \text{ N/mm}^2, f_y = 500 \text{ N/mm}^2$	$d = 30 \text{ to } 55 \text{ cm}$	...	38
18	$f_{ck} = 20 \text{ N/mm}^2, f_y = 500 \text{ N/mm}^2$	$d = 55 \text{ to } 80 \text{ cm}$	...	39

### FLEXURE — Doubly Reinforced Section

19	$f_y = 250 \text{ N/mm}^2, d-d' = 20 \text{ to } 50 \text{ cm}$	...	...	41
20	$f_y = 250 \text{ N/mm}^2, d-d' = 50 \text{ to } 80 \text{ cm}$	...	...	42

### CONTROL OF DEFLECTION

21	$f_y = 250 \text{ N/mm}^2$	...	...	43
22	$f_y = 415 \text{ N/mm}^2$	...	...	44
23	$f_y = 500 \text{ N/mm}^2$	...	...	45

### AXIAL COMPRESSION

24	$f_y = 250 \text{ N/mm}^2$	...	...	109
25	$f_y = 415 \text{ N/mm}^2$	...	...	110
26	$f_y = 500 \text{ N/mm}^2$	...	...	111

**COMPRESSION WITH BENDING — Rectangular Section —  
Reinforcement Distributed Equally on Two Sides**

27	$f_y = 250 \text{ N/mm}^2$	$d'/D = 0.05$	...	...	112
28	$f_y = 250 \text{ N/mm}^2$	$d'/D = 0.10$	...	...	113
29	$f_y = 250 \text{ N/mm}^2$	$d'/D = 0.15$	...	...	114
30	$f_y = 250 \text{ N/mm}^2$	$d'/D = 0.20$	...	...	115
31	$f_y = 415 \text{ N/mm}^2$	$d'/D = 0.05$	...	...	116
32	$f_y = 415 \text{ N/mm}^2$	$d'/D = 0.10$	...	...	117
33	$f_y = 415 \text{ N/mm}^2$	$d'/D = 0.15$	...	...	118
34	$f_y = 415 \text{ N/mm}^2$	$d'/D = 0.20$	...	...	119
35	$f_y = 500 \text{ N/mm}^2$	$d'/D = 0.05$	...	...	120
36	$f_y = 500 \text{ N/mm}^2$	$d'/D = 0.10$	...	...	121
37	$f_y = 500 \text{ N/mm}^2$	$d'/D = 0.15$	...	...	122
38	$f_y = 500 \text{ N/mm}^2$	$d'/D = 0.20$	...	...	123

**COMPRESSION WITH BENDING — Rectangular Section —  
Reinforcement Distributed Equally on Four Sides**

39	$f_y = 250 \text{ N/mm}^2$	$d'/D = 0.05$	...	...	124
40	$f_y = 250 \text{ N/mm}^2$	$d'/D = 0.10$	...	...	125
41	$f_y = 250 \text{ N/mm}^2$	$d'/D = 0.15$	...	...	126
42	$f_y = 250 \text{ N/mm}^2$	$d'/D = 0.20$	...	...	127
43	$f_y = 415 \text{ N/mm}^2$	$d'/D = 0.05$	...	...	128
44	$f_y = 415 \text{ N/mm}^2$	$d'/D = 0.10$	...	...	129
45	$f_y = 415 \text{ N/mm}^2$	$d'/D = 0.15$	...	...	130
46	$f_y = 415 \text{ N/mm}^2$	$d'/D = 0.20$	...	...	131
47	$f_y = 500 \text{ N/mm}^2$	$d'/D = 0.05$	...	...	132
48	$f_y = 500 \text{ N/mm}^2$	$d'/D = 0.10$	...	...	133
49	$f_y = 500 \text{ N/mm}^2$	$d'/D = 0.15$	...	...	134
50	$f_y = 500 \text{ N/mm}^2$	$d'/D = 0.20$	...	...	135

**COMPRESSION WITH BENDING — Circular Section**

51	$f_y = 250 \text{ N/mm}^2$	$d'/D = 0.05$	...	...	136
52	$f_y = 250 \text{ N/mm}^2$	$d'/D = 0.10$	...	...	137
53	$f_y = 250 \text{ N/mm}^2$	$d'/D = 0.15$	...	...	138
54	$f_y = 250 \text{ N/mm}^2$	$d'/D = 0.20$	...	...	139
55	$f_y = 415 \text{ N/mm}^2$	$d'/D = 0.05$	...	...	140
56	$f_y = 415 \text{ N/mm}^2$	$d'/D = 0.10$	...	...	141
57	$f_y = 415 \text{ N/mm}^2$	$d'/D = 0.15$	...	...	142
58	$f_y = 415 \text{ N/mm}^2$	$d'/D = 0.20$	...	...	143
59	$f_y = 500 \text{ N/mm}^2$	$d'/D = 0.05$	...	...	144
60	$f_y = 500 \text{ N/mm}^2$	$d'/D = 0.10$	...	...	145
61	$f_y = 500 \text{ N/mm}^2$	$d'/D = 0.15$	...	...	146
62	$f_y = 500 \text{ N/mm}^2$	$d'/D = 0.20$	...	...	147
63	Values of $P_{uz}$ for Compression Members		...	...	148
64	Biaxial Bending in Compression Members		...	...	149
65	Slender Compression Members — Multiplying Factor $k$ for Additional Moments		...	...	150

**TENSION WITH BENDING — Rectangular Section —  
Reinforcement Distributed Equally on Two Sides**

66	$f_y = 250 \text{ N/mm}^2$	$d'/D = 0.15$ and $0.20$	...	...	151
67	$f_y = 250 \text{ N/mm}^2$	$d'/D = 0.05$ and $0.10$	...	...	152
68	$f_y = 415 \text{ N/mm}^2$	$d'/D = 0.05$	...	...	153
69	$f_y = 415 \text{ N/mm}^2$	$d'/D = 0.10$	...	...	154
70	$f_y = 415 \text{ N/mm}^2$	$d'/D = 0.15$	...	...	155
71	$f_y = 415 \text{ N/mm}^2$	$d'/D = 0.20$	...	...	156
72	$f_y = 500 \text{ N/mm}^2$	$d'/D = 0.05$	...	...	157
73	$f_y = 500 \text{ N/mm}^2$	$d'/D = 0.10$	...	...	158
74	$f_y = 500 \text{ N/mm}^2$	$d'/D = 0.15$	...	...	159
75	$f_y = 500 \text{ N/mm}^2$	$d'/D = 0.20$	...	...	160

**TENSION WITH BENDING — Rectangular Section — Reinforcement  
Distributed Equally on Four Sides**

76	$f_y = 250 \text{ N/mm}^2$	$d'/D = 0.05$ and $0.10$	...	...	161
77	$f_y = 250 \text{ N/mm}^2$	$d'/D = 0.15$ and $0.20$	...	...	162
78	$f_y = 415 \text{ N/mm}^2$	$d'/D = 0.05$	...	...	163
79	$f_y = 415 \text{ N/mm}^2$	$d'/D = 0.10$	...	...	164
80	$f_y = 415 \text{ N/mm}^2$	$d'/D = 0.15$	...	...	165
81	$f_y = 415 \text{ N/mm}^2$	$d'/D = 0.20$	...	...	166
82	$f_y = 500 \text{ N/mm}^2$	$d'/D = 0.05$	...	...	167
83	$f_y = 500 \text{ N/mm}^2$	$d'/D = 0.10$	...	...	168
84	$f_y = 500 \text{ N/mm}^2$	$d'/D = 0.15$	...	...	169
85	$f_y = 500 \text{ N/mm}^2$	$d'/D = 0.20$	...	...	170
86	Axial Compression (Working Stress Design) $\sigma_{ac} = 130 \text{ N/mm}^2$ ...				193
87	Axial Compression (Working Stress Design) $\sigma_{ac} = 190 \text{ N/mm}^2$ ...				194
88	Moment of Inertia of T-Beams				215
89	Effective Moment of Inertia for Calculating Deflection				216
90	Percentage, Area and Spacing of Bars in Slabs				217
91	Effective Length of Columns — Frame Restrained Against Sway ...				218
92	Effective Length of Columns — Frame Without Restraint to Sway				219

## LIST OF TABLES

Table No.		Page
<b>FLEXURE — Reinforcement Percentage, <math>p_t</math> for Singly Reinforced Sections</b>		
1	$f_{ck} = 15 \text{ N/mm}^2$ ... ..	47
2	$f_{ck} = 20 \text{ N/mm}^2$ ... ..	48
3	$f_{ck} = 25 \text{ N/mm}^2$ ... ..	49
4	$f_{ck} = 30 \text{ N/mm}^2$ ... ..	50
<b>FLEXURE — Moment of Resistance of Slabs, kN.m Per Metre Width</b>		
5	$f_{ck} = 15 \text{ N/mm}^2$ $f_y = 250 \text{ N/mm}^2$ Thickness = 10.0 cm ...	51
6	$f_{ck} = 15 \text{ N/mm}^2$ $f_y = 250 \text{ N/mm}^2$ Thickness = 11.0 cm ...	51
7	$f_{ck} = 15 \text{ N/mm}^2$ $f_y = 250 \text{ N/mm}^2$ Thickness = 12.0 cm ...	52
8	$f_{ck} = 15 \text{ N/mm}^2$ $f_y = 250 \text{ N/mm}^2$ Thickness = 13.0 cm ...	52
9	$f_{ck} = 15 \text{ N/mm}^2$ $f_y = 250 \text{ N/mm}^2$ Thickness = 14.0 cm ...	53
10	$f_{ck} = 15 \text{ N/mm}^2$ $f_y = 250 \text{ N/mm}^2$ Thickness = 15.0 cm ...	53
11	$f_{ck} = 15 \text{ N/mm}^2$ $f_y = 250 \text{ N/mm}^2$ Thickness = 17.5 cm ...	54
12	$f_{ck} = 15 \text{ N/mm}^2$ $f_y = 250 \text{ N/mm}^2$ Thickness = 20.0 cm ...	55
13	$f_{ck} = 15 \text{ N/mm}^2$ $f_y = 250 \text{ N/mm}^2$ Thickness = 22.5 cm ...	56
14	$f_{ck} = 15 \text{ N/mm}^2$ $f_y = 250 \text{ N/mm}^2$ Thickness = 25.0 cm ...	57
15	$f_{ck} = 15 \text{ N/mm}^2$ $f_y = 415 \text{ N/mm}^2$ Thickness = 10.0 cm ...	58
16	$f_{ck} = 15 \text{ N/mm}^2$ $f_y = 415 \text{ N/mm}^2$ Thickness = 11.0 cm ...	58
17	$f_{ck} = 15 \text{ N/mm}^2$ $f_y = 415 \text{ N/mm}^2$ Thickness = 12.0 cm ...	59
18	$f_{ck} = 15 \text{ N/mm}^2$ $f_y = 415 \text{ N/mm}^2$ Thickness = 13.0 cm ...	59
19	$f_{ck} = 15 \text{ N/mm}^2$ $f_y = 415 \text{ N/mm}^2$ Thickness = 14.0 cm ...	60
20	$f_{ck} = 15 \text{ N/mm}^2$ $f_y = 415 \text{ N/mm}^2$ Thickness = 15.0 cm ...	61
21	$f_{ck} = 15 \text{ N/mm}^2$ $f_y = 415 \text{ N/mm}^2$ Thickness = 17.5 cm ...	62
22	$f_{ck} = 15 \text{ N/mm}^2$ $f_y = 415 \text{ N/mm}^2$ Thickness = 20.0 cm ...	63
23	$f_{ck} = 15 \text{ N/mm}^2$ $f_y = 415 \text{ N/mm}^2$ Thickness = 22.5 cm ...	64
24	$f_{ck} = 15 \text{ N/mm}^2$ $f_y = 415 \text{ N/mm}^2$ Thickness = 25.0 cm ...	65
25	$f_{ck} = 20 \text{ N/mm}^2$ $f_y = 250 \text{ N/mm}^2$ Thickness = 10.0 cm ...	66
26	$f_{ck} = 20 \text{ N/mm}^2$ $f_y = 250 \text{ N/mm}^2$ Thickness = 11.0 cm ...	66
27	$f_{ck} = 20 \text{ N/mm}^2$ $f_y = 250 \text{ N/mm}^2$ Thickness = 12.0 cm ...	67
28	$f_{ck} = 20 \text{ N/mm}^2$ $f_y = 250 \text{ N/mm}^2$ Thickness = 13.0 cm ...	67
29	$f_{ck} = 20 \text{ N/mm}^2$ $f_y = 250 \text{ N/mm}^2$ Thickness = 14.0 cm ...	68
30	$f_{ck} = 20 \text{ N/mm}^2$ $f_y = 250 \text{ N/mm}^2$ Thickness = 15.0 cm ...	68
31	$f_{ck} = 20 \text{ N/mm}^2$ $f_y = 250 \text{ N/mm}^2$ Thickness = 17.5 cm ...	69
32	$f_{ck} = 20 \text{ N/mm}^2$ $f_y = 250 \text{ N/mm}^2$ Thickness = 20.0 cm ...	70
33	$f_{ck} = 20 \text{ N/mm}^2$ $f_y = 250 \text{ N/mm}^2$ Thickness = 22.5 cm ...	71
34	$f_{ck} = 20 \text{ N/mm}^2$ $f_y = 250 \text{ N/mm}^2$ Thickness = 25.0 cm ...	72

35	$f_{ck} = 20 \text{ N/mm}^2$	$f_y = 415 \text{ N/mm}^2$	Thickness = 10.0 cm	...	73
36	$f_{ck} = 20 \text{ N/mm}^2$	$f_y = 415 \text{ N/mm}^2$	Thickness = 11.0 cm	...	73
37	$f_{ck} = 20 \text{ N/mm}^2$	$f_y = 415 \text{ N/mm}^2$	Thickness = 12.0 cm	...	74
38	$f_{ck} = 20 \text{ N/mm}^2$	$f_y = 415 \text{ N/mm}^2$	Thickness = 13.0 cm	...	74
39	$f_{ck} = 20 \text{ N/mm}^2$	$f_y = 415 \text{ N/mm}^2$	Thickness = 14.0 cm	...	75
40	$f_{ck} = 20 \text{ N/mm}^2$	$f_y = 415 \text{ N/mm}^2$	Thickness = 15.0 cm	...	76
41	$f_{ck} = 20 \text{ N/mm}^2$	$f_y = 415 \text{ N/mm}^2$	Thickness = 17.5 cm	...	77
42	$f_{ck} = 20 \text{ N/mm}^2$	$f_y = 415 \text{ N/mm}^2$	Thickness = 20.0 cm	...	78
43	$f_{ck} = 20 \text{ N/mm}^2$	$f_y = 415 \text{ N/mm}^2$	Thickness = 22.5 cm	...	79
44	$f_{ck} = 20 \text{ N/mm}^2$	$f_y = 415 \text{ N/mm}^2$	Thickness = 25.0 cm	...	80

FLEXURE — Reinforcement Percentages for Doubly Reinforced Sections

45	$f_{ck} = 15 \text{ N/mm}^2$	$f_y = 250 \text{ N/mm}^2$	...	...	81
46	$f_{ck} = 20 \text{ N/mm}^2$	$f_y = 250 \text{ N/mm}^2$	...	...	82
47	$f_{ck} = 25 \text{ N/mm}^2$	$f_y = 250 \text{ N/mm}^2$	...	...	83
48	$f_{ck} = 30 \text{ N/mm}^2$	$f_y = 250 \text{ N/mm}^2$	...	...	84
49	$f_{ck} = 15 \text{ N/mm}^2$	$f_y = 415 \text{ N/mm}^2$	...	...	85
50	$f_{ck} = 20 \text{ N/mm}^2$	$f_y = 415 \text{ N/mm}^2$	...	...	86
51	$f_{ck} = 25 \text{ N/mm}^2$	$f_y = 415 \text{ N/mm}^2$	...	...	87
52	$f_{ck} = 30 \text{ N/mm}^2$	$f_y = 415 \text{ N/mm}^2$	...	...	88
53	$f_{ck} = 15 \text{ N/mm}^2$	$f_y = 500 \text{ N/mm}^2$	...	...	89
54	$f_{ck} = 20 \text{ N/mm}^2$	$f_y = 500 \text{ N/mm}^2$	...	...	90
55	$f_{ck} = 25 \text{ N/mm}^2$	$f_y = 500 \text{ N/mm}^2$	...	...	91
56	$f_{ck} = 30 \text{ N/mm}^2$	$f_y = 500 \text{ N/mm}^2$	...	...	92

FLEXURE — Limiting Moment of Resistance Factor,  $M_{u,lim}/b_w d^2 f_{ck}$ , for Singly Reinforced T-beams  $\text{N/mm}^2$

57	$f_y = 250 \text{ N/mm}^2$	...	...	93
58	$f_y = 415 \text{ N/mm}^2$	...	...	94
59	$f_y = 500 \text{ N/mm}^2$	...	...	95
60	Slender Compression Members — Values of $P_s$	...	...	171
61	Shear — Design Shear Strength of Concrete, $\tau_c$ , $\text{N/mm}^2$	...	...	178
62	Shear — Vertical Stirrups	...	...	179
63	Shear — Bent-up Bars	...	...	179

DEVELOPMENT LENGTH

64	Plain Bars	...	...	184
65	Deformed bars, $f_y = 415 \text{ N/mm}^2$	...	...	184
66	Deformed bars, $f_y = 500 \text{ N/mm}^2$	...	...	185
67	Anchorage Value of Hooks and Bends	...	...	186

WORKING STRESS METHOD — FLEXURE — Moment of Resistance Factor,  $M/bd^2$ ,  $\text{N/mm}^2$  for Singly Reinforced Sections

68	$\sigma_{cbc} = 5.0 \text{ N/mm}^2$	...	...	195
69	$\sigma_{cbc} = 7.0 \text{ N/mm}^2$	...	...	196
70	$\sigma_{cbc} = 8.5 \text{ N/mm}^2$	...	...	197
71	$\sigma_{cbc} = 10.0 \text{ N/mm}^2$	...	...	198



**WORKING STRESS DESIGN — FLEXURE — Reinforcement  
Percentages for Doubly Reinforced Sections**

72	$\sigma_{cbc} = 5.0 \text{ N/mm}^2$	$\sigma_{st} = 140 \text{ N/mm}^2$	...	...	199
73	$\sigma_{cbc} = 7.0 \text{ N/mm}^2$	$\sigma_{st} = 140 \text{ N/mm}^2$	...	...	200
74	$\sigma_{cbc} = 8.5 \text{ N/mm}^2$	$\sigma_{st} = 140 \text{ N/mm}^2$	...	...	201
75	$\sigma_{cbc} = 10.0 \text{ N/mm}^2$	$\sigma_{st} = 140 \text{ N/mm}^2$	...	...	202
76	$\sigma_{cbc} = 5.0 \text{ N/mm}^2$	$\sigma_{st} = 230 \text{ N/mm}^2$	...	...	203
77	$\sigma_{cbc} = 7.0 \text{ N/mm}^2$	$\sigma_{st} = 230 \text{ N/mm}^2$	...	...	204
78	$\sigma_{cbc} = 8.5 \text{ N/mm}^2$	$\sigma_{st} = 230 \text{ N/mm}^2$	...	...	205
79	$\sigma_{cbc} = 10.0 \text{ N/mm}^2$	$\sigma_{st} = 230 \text{ N/mm}^2$	...	...	206

**WORKING STRESS METHOD — SHEAR**

80	Permissible Shear Stress in Concrete $\tau_c, \text{ N/mm}^2$	...	...	207
81	Vertical Stirrups	...	...	207
82	Bent-up Bars	...	...	208

**WORKING STRESS METHOD — DEVELOPMENT LENGTH**

83	Plain Bars	...	208
84	Deformed Bars — $\sigma_{st} = 230 \text{ N/mm}^2, \sigma_{sc} = 190 \text{ N/mm}^2$	...	209
85	Deformed Bars — $\sigma_{st} = 275 \text{ N/mm}^2, \sigma_{sc} = 190 \text{ N/mm}^2$	...	209
86	Moment of Inertia — Values of $bd^3/12\ 000$	...	220

**MOMENT OF INERTIA OF CRACKED SECTION—Values of  $I_c \left( \frac{bd^3}{12} \right)$**

87	$d'/d = 0.05$	...	221
88	$d'/d = 0.10$	...	222
89	$d'/d = 0.15$	...	223
90	$d'/d = 0.20$	...	224

**DEPTH OF NEUTRAL AXIS — Values of  $n/d$  by Elastic Theory**

91	$d'/d = 0.05$	...	225
92	$d'/d = 0.10$	...	226
93	$d'/d = 0.15$	...	227
94	$d'/d = 0.20$	...	228
95	Areas of Given Numbers of Bars in $\text{cm}^2$	...	229
96	Areas of Bars at Given Spacings	...	230
97	Fixed End Moments for Prismatic Beams	...	231
98	Deflection Formulae for Prismatic Beams	...	232

## SYMBOLS

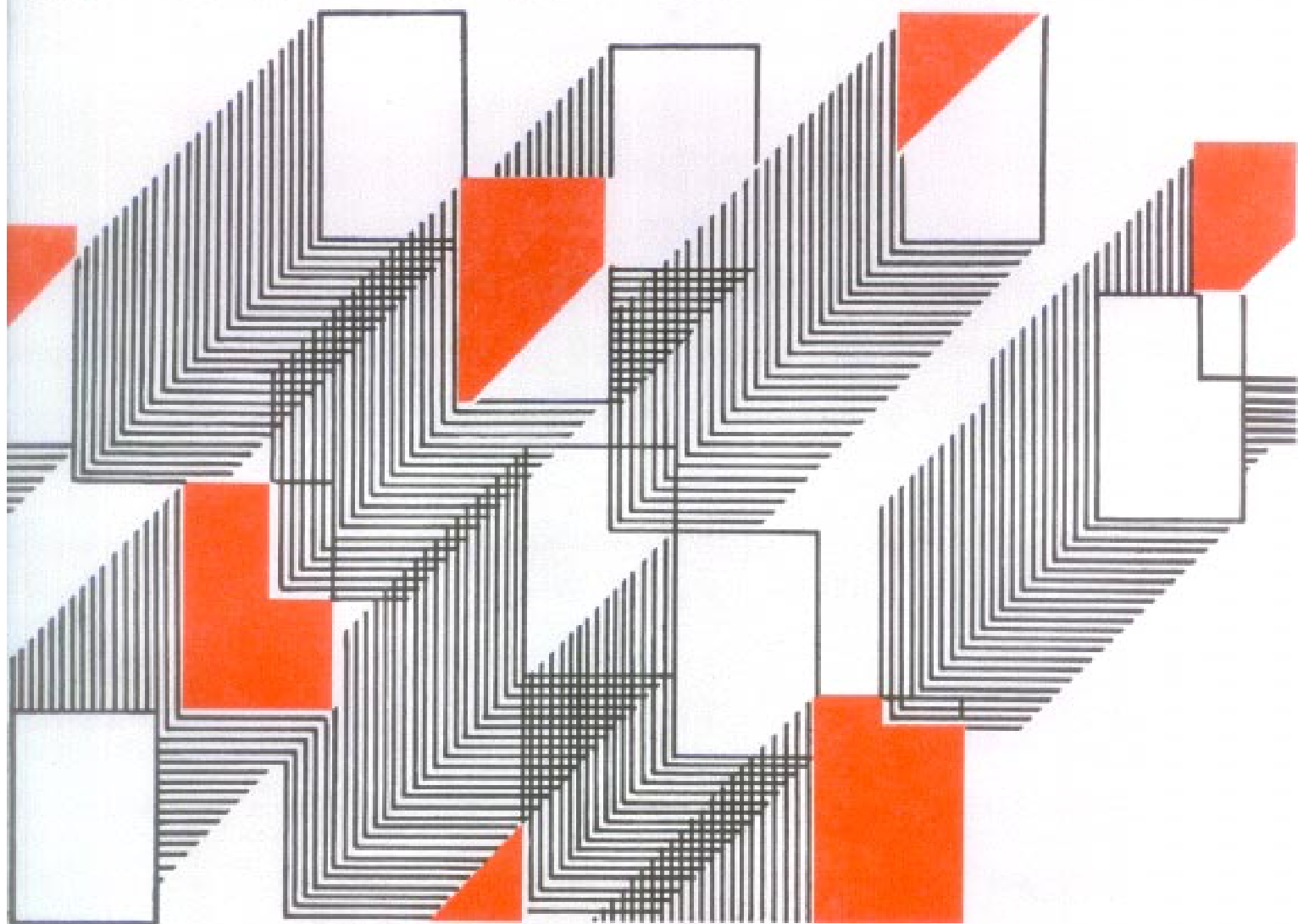
<p><math>A_c</math> = Area of concrete</p> <p><math>A_g</math> = Gross area of section</p> <p><math>A_s</math> = Area of steel in a column or in a singly reinforced beam or slab</p> <p><math>A_{sc}</math> = Area of compression steel</p> <p><math>A_{sv}</math> = Area of stirrups</p> <p><math>A_{st2}</math> = Area of additional tensile reinforcement</p> <p><math>a_{cc}</math> = Deflection due to creep</p> <p><math>a_{cs}</math> = Deflection due to shrinkage</p> <p><math>b</math> = Breadth of beam or shorter dimensions of a rectangular column</p> <p><math>b_f</math> = Effective width of flange in a T-beam</p> <p><math>b_w</math> = Breadth of web in a T-beam</p> <p><math>b_1</math> = Centre-to-centre distance between corner bars in the direction of width</p> <p><math>D</math> = Overall depth of beam or slab or diameter of column or larger dimension in a rectangular column or dimension of a rectangular column in the direction of bending</p> <p><math>D_f</math> = Thickness of flange in a T-beam</p> <p><math>d</math> = Effective depth of a beam or slab</p> <p><math>d', d^1</math> = distance of centroid of compression reinforcement from the extreme compression fibre of the concrete section</p> <p><math>d_1</math> = Centre to centre distance between corner bars in the direction of depth</p> <p><math>E_c</math> = Modulus of elasticity of concrete</p> <p><math>E_s</math> = Modulus of elasticity of steel</p> <p><math>e_{ax}</math> = Eccentricity with respect to major axis (<math>xx</math>-axis)</p> <p><math>e_{ay}</math> = Eccentricity with respect to minor axis (<math>yy</math>-axis)</p> <p><math>e_{min}</math> = Minimum eccentricity</p> <p><math>f_{cc}</math> = Compressive stress in concrete at the level of centroid of compression reinforcement</p> <p><math>f_{ck}</math> = Characteristic compressive strength of concrete</p>	<p><math>f_{cr}</math> = Flexural tensile strength (modulus of rupture) of concrete</p> <p><math>f_s</math> = Stress in steel</p> <p><math>f_{sc}</math> = Compressive stress in steel corresponding to a strain of 0.002</p> <p><math>f_{st}</math> = Stress in the reinforcement nearest to the tension face of a member subjected to combined axial load and bending</p> <p><math>f_y</math> = Characteristic yield strength of steel</p> <p><math>f_{yd}</math> = Design yield strength of steel</p> <p><math>I_{eff}</math> = Effective moment of inertia</p> <p><math>I_{gr}</math> = Moment of inertia of the gross section about centroidal axis, neglecting reinforcement</p> <p><math>I_r</math> = Moment of inertia of cracked section</p> <p><math>K_b</math> = Flexural stiffness of beam</p> <p><math>K_c</math> = Flexural stiffness of column</p> <p><math>k</math> = Constant or coefficient or factor</p> <p><math>L_d</math> = Development length of bar</p> <p><math>l</math> = Length of column or span of beam</p> <p><math>l_{ex}</math> = Effective length of a column, bending about <math>xx</math>-axis</p> <p><math>l_{ey}</math> = Effective length of a column, bending about <math>yy</math>-axis</p> <p><math>M</math> = Maximum moment under service loads</p> <p><math>M_r</math> = Cracking moment</p> <p><math>M_u</math> = Design moment for limit state Design (factored moment)</p> <p><math>M_{u,lim}</math> = Limiting moment of resistance of a singly reinforced rectangular beam</p> <p><math>M_{ux}</math> = Design moment about <math>xx</math>-axis</p> <p><math>M_{uy}</math> = Design moment about <math>yy</math>-axis</p> <p><math>M_{ux1}</math> = Maximum uniaxial moment capacity of the section with axial load, bending about <math>xx</math>-axis</p>
---	--

$M_{uy1}$	= Maximum uniaxial moment capacity of the section with axial load, bending about $yy$ -axis	$x_1$	= Shorter dimension of the stirrup
$M_{e1}$	= Equivalent bending moment	$x_u$	= Depth of neutral axis at the limit state of collapse
$M_{u2}$	= Additional moment, $M_u - M_{u,lim}$ in doubly reinforced beams	$x_{u,max}$	= Maximum depth of neutral axis in limit state design
$M_{u,lim,T}$	= Limiting moment of resistance of a T-beam	$y_t$	= Distance from centroidal axis of gross section, neglecting reinforcement, to extreme fibre in tension
$m$	= Modular ratio	$y_1$	= Longer dimension of stirrup
$P$	= Axial load	$Z$	= Lever arm
$P_b$	= Axial load corresponding to the condition of maximum compressive strain of 0.0035 in concrete and 0.002 in the outermost layer of tension steel in a compression member	$\alpha$	= Angle
$P_u$	= Design axial load for limit state design (factored load)	$\gamma_f$	= Partial safety factor for load
$p$	= Percentage of reinforcement	$\gamma_m$	= Partial safety factor for material strength
$p_c$	= Percentage of compression reinforcement, $100 A_{sc}/bd$	$\xi_{cc}$	= Creep strain in concrete
$p_t$	= Percentage of tension reinforcement, $100 A_{st}/bd$	$\sigma_{cbc}$	= Permissible stress in concrete in bending compression
$p_{t2}$	= Additional percentage of tensile reinforcement in doubly reinforced beams, $100 A_{st2}/bd$	$\sigma_{cc}$	= Permissible stress in concrete in direct compression
$s_v$	= Spacing of stirrups	$\sigma_s$	= Stress in steel bar
$T_u$	= Torsional moment due to factored loads	$\sigma_{sc}$	= Permissible stress in steel in compression
$V$	= Shear force	$\sigma_{st}$	= Permissible stress in steel in tension
$V_s$	= Strength of shear reinforcement (working stress design)	$\sigma_{sv}$	= Permissible stress in shear reinforcement
$V_u$	= Shear force due to factored loads	$\tau_v$	= Nominal shear stress
$V_{us}$	= Strength of shear reinforcement (limit state design)	$\tau_{bd}$	= Design bond stress
$x$	= Depth of neutral axis at service loads	$\tau_c$	= Shear stress in concrete
		$\tau_{vo}$	= Equivalent shear stress
		$\tau_{c,max}$	= Maximum shear stress in concrete with shear reinforcement
		$\theta$	= Creep coefficient
		$\phi$	= Diameter of bar

## CONVERSION FACTORS

<i>To Convert</i>	<i>into</i>	<i>Multiply by</i>	<i>Conversely Multiply by</i>
(1)	(2)	(3)	(4)
<b>Loads and Forces</b>			
Newton	kilogram	0·102 0	9·807
Kilonewton	Tonne	0·102 0	9·807
<b>Moments and Torques</b>			
Newton metre	kilogram metre	0·102 0	9·807
Kilonewton metre	Tonne metre	0·102 0	9·807
<b>Stresses</b>			
Newton per mm <sup>2</sup>	kilogram per mm <sup>2</sup>	0·102 0	9·807
Newton per mm <sup>2</sup>	kilogram per cm <sup>2</sup>	10·20	0·0981

# MATERIAL STRENGTH AND STRESS-STRAIN RELATIONSHIPS





As in the Original Standard, this Page is Intentionally Left Blank

# 1. MATERIAL STRENGTHS AND STRESS-STRAIN RELATIONSHIPS

## 1.1 GRADES OF CONCRETE

The following six grades of concrete can be used for reinforced concrete work as specified in Table 2 of the Code (IS : 456-1978\*):

M 15, M 20, M 25, M 30, M 35 and M 40.

The number in the grade designation refers to the characteristic compressive strength,  $f_{ck}$ , of 15 cm cubes at 28 days, expressed in N/mm<sup>2</sup>; the characteristic strength being defined as the strength below which not more than 5 percent of the test results are expected to fall.

\*Code of practice for plain and reinforced concrete (third revision).

1.1.1 Generally, Grades M 15 and M 20 are used for flexural members. Charts for flexural members and tables for slabs are, therefore, given for these two grades only. However, tables for design of flexural members are given for Grades M 15, M 20, M 25 and M 30.

1.1.2 The charts for compression members are applicable to all grades of concrete.

## 1.2 TYPES AND GRADES OF REINFORCEMENT BARS

The types of steel permitted for use as reinforcement bars in 4.6 of the Code and their characteristic strengths (specified minimum yield stress or 0.2 percent proof stress) are as follows:

Type of Steel	Indian Standard	Yield Stress or 0.2 Percent Proof Stress
Mild steel (plain bars)	IS : 432 (Part I)-1966*	26 kgf/mm <sup>2</sup> for bars up to 20 mm dia 24 kgf/mm <sup>2</sup> for bars over 20 mm dia
Mild steel (hot-rolled deformed bars)	IS : 1139-1966†	
Medium tensile steel (plain bars)	IS : 432 (Part I)-1966*	36 kgf/mm <sup>2</sup> for bars up to 20 mm dia 34.5 kgf/mm <sup>2</sup> for bars over 20 mm dia up to 40 mm dia 33 kgf/mm <sup>2</sup> for bars over 40 mm dia
Medium tensile steel (hot-rolled deformed bars)	IS : 1139-1966†	
High yield strength steel (hot-rolled deformed bars)	IS : 1139-1966†	
High yield strength steel (cold-twisted deformed bars)	IS : 1786-1979‡	415 N/mm <sup>2</sup> for all bar sizes 500 N/mm <sup>2</sup> for all bar sizes
Hard-drawn steel wire fabric	IS : 1566-1967§ and IS : 432 (Part II)-1966	

NOTE—SI units have been used in IS: 1786-1979‡; in other Indian Standards, SI units will be adopted in their next revisions.

\*Specification for mild steel and medium tensile steel bars and hard-drawn steel wire for concrete reinforcement: Part I Mild steel and medium tensile steel bars (second revision).

†Specification for hot rolled mild steel, medium tensile steel and high yield strength steel deformed bars for concrete reinforcement (revised).

‡Specification for cold-worked steel high strength deformed bars for concrete reinforcement (second revision).

§Specification for hard-drawn steel wire fabric for concrete reinforcement (first revision).

||Specification for mild steel and medium tensile steel bars and hard-drawn steel wire for concrete reinforcement: Part II Hard drawn steel wire (second revision).

Taking the above values into consideration, most of the charts and tables have been prepared for three grades of steel having characteristic strength  $f_y$  equal to 250 N/mm<sup>2</sup>, 415 N/mm<sup>2</sup> and 500 N/mm<sup>2</sup>.

1.2.1 If the steel being used in a design has a strength which is slightly different from the above values, the chart or table for the nearest value may be used and the area of reinforcement thus obtained be modified in proportion to the ratio of the strengths.

1.2.2 Five values of  $f_y$  (including the value for hard-drawn steel wire fabric) have been included in the tables for singly reinforced sections.

### 1.3 STRESS-STRAIN RELATIONSHIP FOR CONCRETE

The Code permits the use of any appropriate curve for the relationship between the compressive stress and strain distribution in concrete, subject to the condition that it results in the prediction of strength in substantial agreement with test results [37.1(c) of the Code]. An acceptable stress-strain curve (see Fig. 1) given in Fig. 20 of the Code will form the basis for the design aids in this publication. The compressive strength of concrete in the structure is assumed to be  $0.67 f_{ck}$ . With a value of 1.5 for the partial safety factor  $\gamma_m$  for material strength (35.4.2.1 of the Code), the maximum compressive stress in concrete for design purpose is  $0.446 f_{ck}$  (see Fig. 1).

### 1.4 STRESS-STRAIN RELATIONSHIP FOR STEEL

The modulus of elasticity of steel,  $E_s$ , is taken as 200 000 N/mm<sup>2</sup> (4.6.2 of the Code). This value is applicable to all types of reinforcing steels.

The design yield stress (or 0.2 percent proof stress) of steel is equal to  $f_y/\gamma_m$ . With a value of 1.15 for  $\gamma_m$  (35.4.2.1 of the Code), the design yield stress  $f_{yd}$  becomes  $0.87 f_y$ . The stress-strain relationship for steel in tension and compression is assumed to be the same.

For mild steel, the stress is proportional to strain up to yield point and thereafter the strain increases at constant stress (see Fig. 2). For cold-worked bars, the stress-strain relationship given in Fig. 22 of the Code will

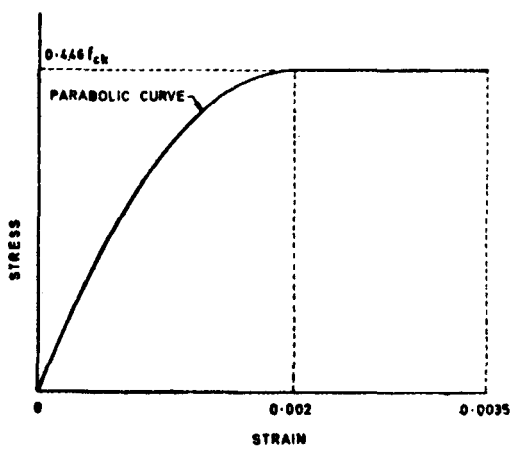


FIG. 1 DESIGN STRESS-STRAIN CURVE FOR CONCRETE

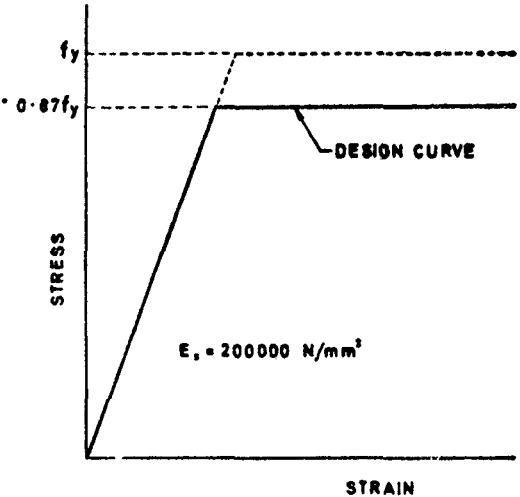


FIG. 2 STRESS-STRAIN CURVE FOR MILD STEEL

be adopted. According to this, the stress is proportional to strain up to a stress of  $0.87 f_y$ . Thereafter, the stress-strain curve is defined as given below:

Stress	Inelastic strain
$0.80 f_y$	Nil
$0.85 f_y$	0.000 1
$0.90 f_y$	0.000 3
$0.95 f_y$	0.000 7
$0.975 f_y$	0.001 0
$1.0 f_y$	0.002 0

The stress-strain curve for design purposes is obtained by substituting  $f_{yd}$  for  $f_y$  in the above. For two grades of cold-worked bars with 0.2 percent proof stress values of 415 N/mm<sup>2</sup> and 500 N/mm<sup>2</sup> respectively, the values of total strains and design stresses corresponding to the points defined above are given in Table A (see page 6). The stress-strain curves for these two grades of cold-worked bars have been plotted in Fig. 3.

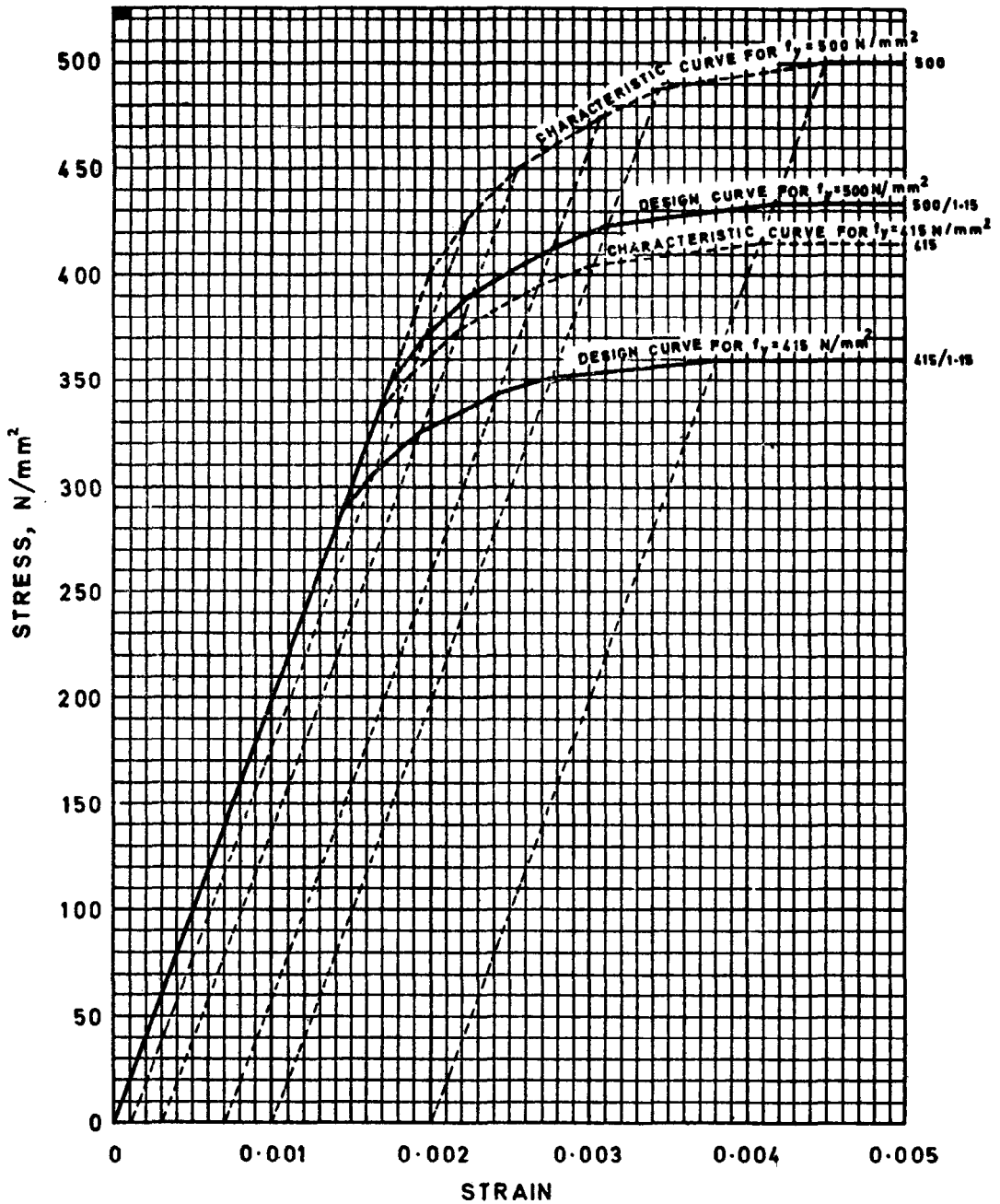


FIG. 3 STRESS-STRAIN CURVES FOR COLD-WORKED STEELS

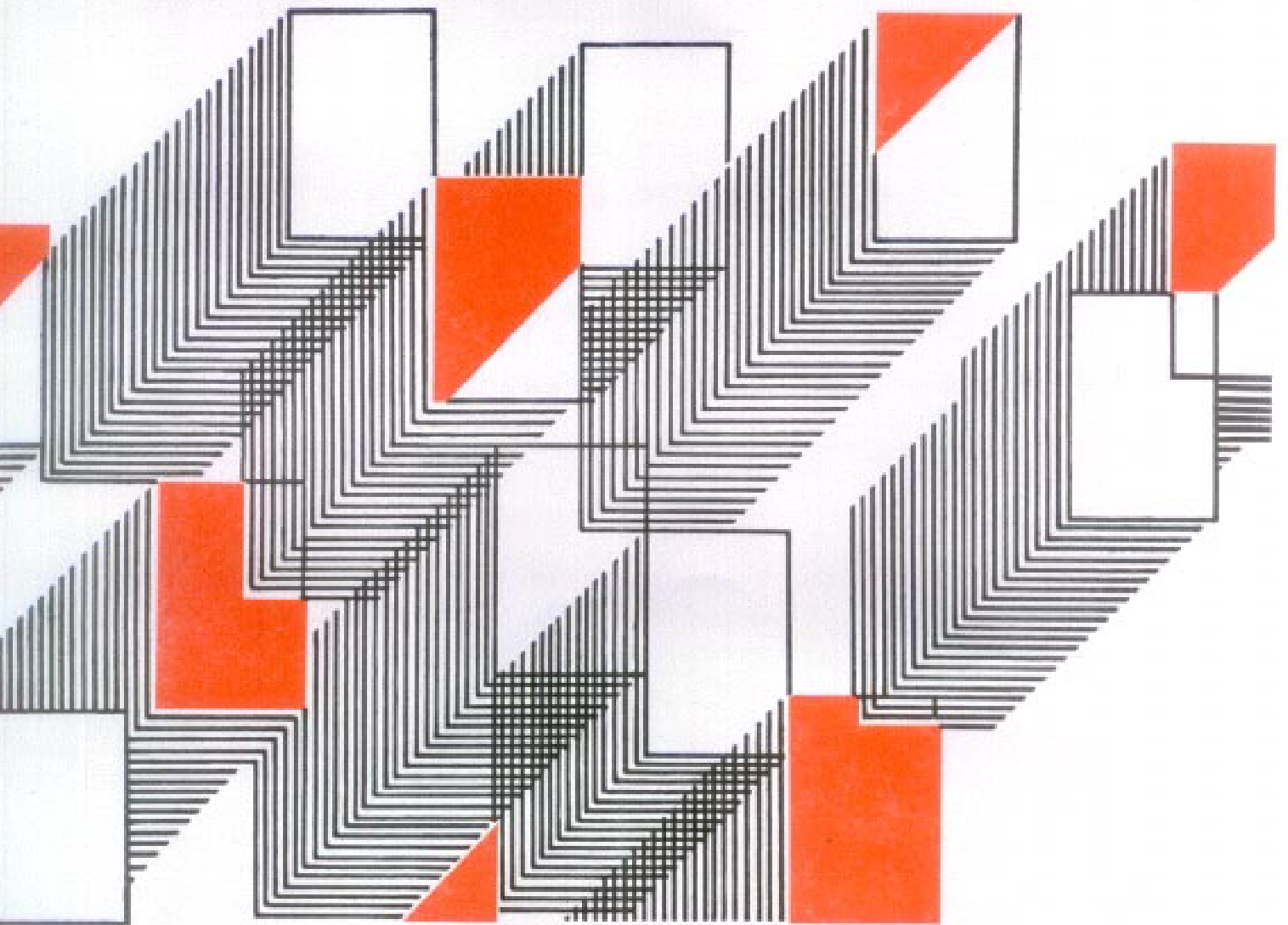
TABLE A SALIENT POINTS ON THE DESIGN STRESS-STRAIN CURVE FOR COLD-WORKED BARS

( Clause 1.4 )

STRESS LEVEL  (1)	$f_y = 415 \text{ N/mm}^2$		$f_y = 500 \text{ N/mm}^2$	
	Strain (2)	Stress (3) N/mm <sup>2</sup>	Strain (4)	Stress (5) N/mm <sup>2</sup>
0.80 $f_{yd}$	0.001 44	288.7	0.001 74	347.8
0.85 $f_{yd}$	0.001 63	306.7	0.001 95	369.6
0.90 $f_{yd}$	0.001 92	324.8	0.002 26	391.3
0.95 $f_{yd}$	0.002 41	342.8	0.002 77	413.0
0.975 $f_{yd}$	0.002 76	351.8	0.003 12	423.9
1.0 $f_{yd}$	0.003 80	360.9	0.004 17	434.8

NOTE -- Linear interpolation may be done for intermediate values.

# FLEXURAL MEMBERS



As in the Original Standard, this Page is Intentionally Left Blank

## 2. FLEXURAL MEMBERS

### 2.1 ASSUMPTIONS

The basic assumptions in the design of flexural members for the limit state of collapse are given below (see 37.1 of the Code):

- Plane sections normal to the axis of the member remain plane after bending. This means that the strain at any point on the cross section is directly proportional to the distance from the neutral axis.
- The maximum strain in concrete at the outermost compression fibre is 0.0035.
- The design stress-strain relationship for concrete is taken as indicated in Fig. 1.
- The tensile strength of concrete is ignored.
- The design stresses in reinforcement are derived from the strains using the stress-strain relationships given in Fig. 2 and 3.
- The strain in the tension reinforcement is to be not less than

$$\frac{0.87 f_y}{E_s} + 0.002.$$

This assumption is intended to ensure ductile failure, that is, the tensile reinforcement has to undergo a certain degree of inelastic deformation before the concrete fails in compression.

### 2.2 MAXIMUM DEPTH OF NEUTRAL AXIS

Assumptions (b) and (f) govern the maximum depth of neutral axis in flexural members. The strain distribution across a member corresponding to those limiting conditions is shown in Fig. 4. The maximum depth of neutral axis  $x_{u, \max}$  is obtained directly from the strain diagram by considering similar triangles.

$$\frac{x_{u, \max}}{d} = \frac{0.0035}{(0.0035 + 0.87 f_y / E_s)}$$

The values of  $\frac{x_{u, \max}}{d}$  for three grades of reinforcing steel are given in Table B.

TABLE B VALUES OF  $\frac{x_{u, \max}}{d}$  FOR DIFFERENT GRADES OF STEEL (Clause 2.2)

$f_y, \text{N/mm}^2$	250	415	500
$\frac{x_{u, \max}}{d}$	0.531	0.479	0.456

### 2.3 RECTANGULAR SECTIONS

The compressive stress block for concrete is represented by the design stress-strain curve as in Fig. 1. It is seen from this stress block (see Fig. 4) that the centroid of compressive force in a rectangular section lies

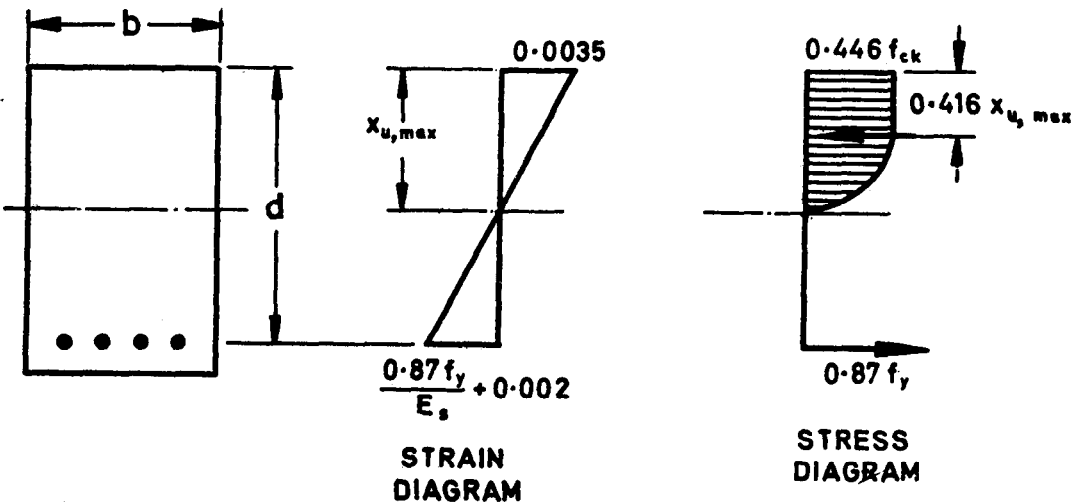


FIG. 4 SINGLY REINFORCED SECTION



at a distance of  $0.416 x_u$  (which has been rounded off to  $0.42 x_u$  in the code) from the extreme compression fibre; and the total force of compression is  $0.36 f_{ck} b x_u$ . The lever arm, that is, the distance between the centroid of compressive force and centroid of tensile force is equal to  $(d - 0.416 x_u)$ . Hence the upper limit for the moment of resistance of a singly reinforced rectangular section is given by the following equation:

$$M_{u,lim} = 0.36 f_{ck} b x_{u,max} \times (d - 0.416 x_{u,max})$$

Substituting for  $x_{u,max}$  from Table B and transposing  $f_{ck} b d^2$ , we get the values of the limiting moment of resistance factors for singly reinforced rectangular beams and slabs. These values are given in Table C. The tensile reinforcement percentage,  $p_{t,lim}$  corresponding to the limiting moment of resistance is obtained by equating the forces of tension and compression.

$$\frac{p_{t,lim} b d (0.87 f_y)}{100} = 0.36 f_{ck} b x_{u,max}$$

Substituting for  $x_{u,max}$  from Table B, we get the values of  $p_{t,lim} f_y/f_{ck}$  as given in Table C.

TABLE C LIMITING MOMENT OF RESISTANCE AND REINFORCEMENT INDEX FOR SINGLY REINFORCED RECTANGULAR SECTIONS (Clause 2.3)

$f_y$ , N/mm <sup>2</sup>	250	415	500
$\frac{M_{u,lim}}{f_{ck} b d^2}$	0.149	0.138	0.133
$\frac{p_{t,lim} f_y}{f_{ck}}$	21.97	19.82	18.87

The values of the limiting moment of resistance factor  $M_u/bd^2$  for different grades of concrete and steel are given in Table D. The corresponding percentages of reinforcements are given in Table E. These are the maximum permissible percentages for singly reinforced sections.

TABLE D LIMITING MOMENT OF RESISTANCE FACTOR  $M_{u,lim}/bd^2$ , N/mm<sup>2</sup> FOR SINGLY REINFORCED RECTANGULAR SECTIONS (Clause 2.3)

$f_{ck}$ , N/mm <sup>2</sup>	$f_y$ , N/mm <sup>2</sup>		
	250	415	500
15	2.24	2.07	2.00
20	2.98	2.76	2.66
25	3.73	3.45	3.33
30	4.47	4.14	3.99

TABLE E MAXIMUM PERCENTAGE OF TENSILE REINFORCEMENT  $p_{t,lim}$  FOR SINGLY REINFORCED RECTANGULAR SECTIONS

(Clause 2.3)

$f_{ck}$ , N/mm <sup>2</sup>	$f_y$ , N/mm <sup>2</sup>		
	250	415	500
15	1.32	0.72	0.57
20	1.76	0.96	0.76
25	2.20	1.19	0.94
30	2.64	1.43	1.13

### 2.3.1 Under-Reinforced Sections

Under-reinforced section means a singly reinforced section with reinforcement percentage not exceeding the appropriate value given in Table E. For such sections, the depth of neutral axis  $x_u$  will be smaller than  $x_{u,max}$ . The strain in steel at the limit state of collapse will, therefore, be more than  $\frac{0.87 f_y}{E_s} + 0.002$  and, the design stress in steel will be  $0.87 f_y$ . The depth of neutral axis is obtained by equating the forces of tension and compression.

$$\frac{p_t b d}{100} (0.87 f_y) = 0.36 f_{ck} b x_u$$

$$\frac{x_u}{d} = \left( \frac{p_t}{100} \right) \frac{0.87 f_y}{0.36 f_{ck}}$$

The moment of resistance of the section is equal to the product of the tensile force and the lever arm.

$$M_u = \frac{p_t b d}{100} (0.87 f_y) (d - 0.416 x_u) = 0.87 f_y \left( \frac{p_t}{100} \right) \left( 1 - 0.416 \frac{x_u}{d} \right) b d^2$$

Substituting for  $\frac{x_u}{d}$  we get

$$M_u = 0.87 f_y \left( \frac{p_t}{100} \right) \times \left[ 1 - 1.005 \frac{f_y}{f_{ck}} \left( \frac{p_t}{100} \right) \right] b d^2$$

2.3.1.1 Charts 1 to 18 have been prepared by assigning different values to  $M_u/b$  and plotting  $d$  versus  $p_t$ . The moment values in the charts are in units of kN.m per metre width. Charts are given for three grades of steel and two grades of concrete, namely M 15 and M 20, which are most commonly used for flexural members. Tables 1 to 4 cover a wider range, that is, five values of  $f_y$  and four grades of concrete up to M 30. In these tables, the values of percentage of reinforcement  $p_t$  have been tabulated against  $M_u/bd^2$ .

2.3.1.2 The moment of resistance of slabs, with bars of different diameters and spacings are given in Tables 5 to 44. Tables are given for concrete grades M 15 and M 20, with two grades of steel. Ten different thicknesses ranging from 10 cm to 25 cm, are included. These tables take into account 25.5.2.2 of the Code, that is, the maximum bar diameter does not exceed one-eighth the thickness of the slab. Clear cover for reinforcement has been taken as 15 mm or the bar diameter, whichever is greater [see 25.4.1(d) of the Code]. In these tables, the zeros at the top right hand corner indicate the region where the reinforcement percentage would exceed  $p_{t,lim}$ ; and the zeros at the lower left hand corner indicate the region where the reinforcement is less than the minimum according to 25.5.2.1 of the Code.

#### Example 1 Singly Reinforced Beam

Determine the main tension reinforcement required for a rectangular beam section with the following data:

Size of beam	30 × 60 cm
Concrete mix	M 15
Characteristic strength of reinforcement	415 N/mm <sup>2</sup>
*Factored moment	170 kN.m

\*Assuming 25 mm dia bars with 25 mm clear cover,

$$\text{Effective depth} = 60 - 2.5 - \frac{2.5}{2} = 56.25 \text{ cm}$$

From Table D, for  $f_y = 415 \text{ N/mm}^2$  and  $f_{ck} = 15 \text{ N/mm}^2$

$$\begin{aligned} M_{u,lim}/bd^2 &= 2.07 \text{ N/mm}^2 \\ &= \frac{2.07}{1000} \times (1000)^2 \\ &= 2.07 \times 10^3 \text{ kN/m}^2 \end{aligned}$$

$$\begin{aligned} \therefore M_{u,lim} &= 2.07 \times 10^3 bd^2 \\ &= 2.07 \times 10^3 \times \frac{30}{100} \times \left(\frac{56.25}{100}\right)^2 \\ &= 196.5 \text{ kN.m} \end{aligned}$$

Actual moment of 170 kN.m is less than  $M_{u,lim}$ . The section is therefore to be designed as a singly reinforced (under-reinforced) rectangular section.

#### METHOD OF REFERRING TO FLEXURE CHART

For referring to Chart, we need the value of moment per metre width.

$$M_u/b = \frac{170}{0.3} = 567 \text{ kN.m per metre width.}$$

\*The term 'factored moment' means the moment due to characteristic loads multiplied by the appropriate value of partial safety factor  $\gamma_f$ .

Referring to Chart 6, corresponding to

$$M_u/b = 567 \text{ kN.m and } d = 56.25 \text{ cm,}$$

$$\text{Percentage of steel } p_t = \frac{100A_s}{bd} = 0.6$$

$$\therefore A_s = \frac{0.6 bd}{100} = \frac{0.6 \times 30 \times 56.25}{100} = 10.1 \text{ cm}^2$$

#### METHOD OF REFERRING TO TABLES

For referring to Tables, we need the value of

$$\begin{aligned} \text{of } \frac{M_u}{bd^2} &= \frac{170 \times 10^6}{30 \times 56.25 \times 56.25 \times 10^3} \\ &= 1.79 \text{ N/mm}^2 \end{aligned}$$

From Table 1,

Percentage of reinforcement,  $p_t = 0.594$

$$\therefore A_s = \frac{0.594 \times 30 \times 56.25}{100} = 10.02 \text{ cm}^2$$

#### Example 2 Slab

Determine the main reinforcement required for a slab with the following data:

Factored moment	9.60 kN.m per metre width
Depth of slab	10 cm
Concrete mix	M 15
Characteristic strength of reinforcement	a) 415 N/mm <sup>2</sup> b) 250 N/mm <sup>2</sup>

#### METHOD OF REFERRING TO TABLES FOR SLABS

Referring to Table 15 (for  $f_y = 415 \text{ N/mm}^2$ ), directly we get the following reinforcement for a moment of resistance of 9.6 kN.m per metre width:

8 mm dia at 13 cm spacing  
or 10 mm dia at 20 cm spacing

Reinforcement given in the tables is based on a cover of 15 mm or bar diameter whichever is greater.

#### METHOD OF REFERRING TO FLEXURE CHART

Assume 10 mm dia bars with 15 mm cover,

$$d = 10 - 1.5 - \frac{1.0}{2} = 8 \text{ cm}$$

a) For  $f_y = 415 \text{ N/mm}^2$

From Table D,  $M_{u,lim}/bd^2 = 2.07 \text{ N/mm}^2$

$$\begin{aligned} \therefore M_{u,lim} &= 2.07 \times 10^3 \times \frac{100}{100} \times \left(\frac{8}{100}\right)^2 \\ &= 13.25 \text{ kN.m} \end{aligned}$$

Actual bending moment of 9.60 kN.m is less than the limiting bending moment.

Referring to *Chart 4*, reinforcement percentage,  $p_t = 0.475$

Referring to *Chart 90*, provide 8 mm dia at 13 cm spacing or 10 mm dia at 20 cm spacing.

Alternately,

$$A_s = 0.475 \times 100 \times \frac{8}{100} = 3.8 \text{ cm}^2 \text{ per metre width.}$$

From *Table 96*, we get the same reinforcement as before.

b) For  $f_y = 250 \text{ N/mm}^2$

From *Table D*,  $M_{u,lim}/bd^2 = 2.24 \text{ N/mm}^2$

$$M_{u,lim} = 2.24 \times 10^3 \times 1 \times \left(\frac{8}{100}\right)^2 = 14.336 \text{ kN.m}$$

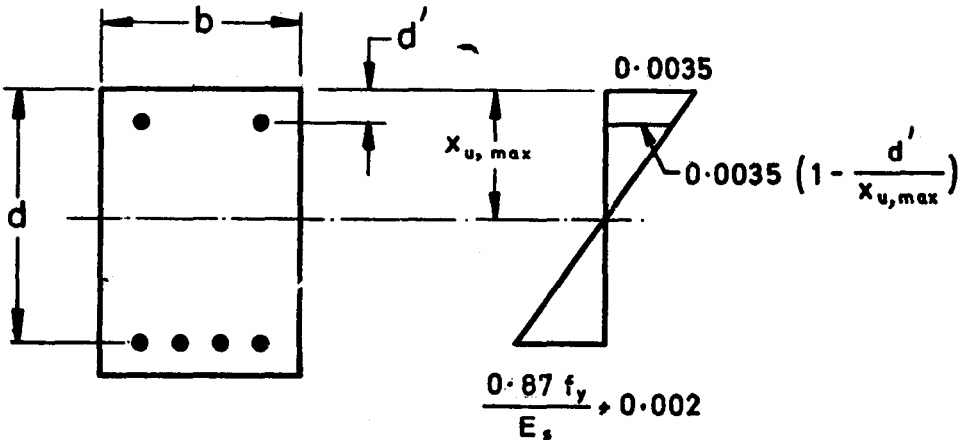
Actual bending moment of 9.6 kN.m is less than the limiting bending moment.

Referring to *Chart 1*, reinforcement percentage,  $p_t = 0.78$

Referring to *Chart 90*, provide 10 mm dia at 13 cm spacing.

**2.3.2 Doubly Reinforced Sections**—Doubly reinforced sections are generally adopted when the dimensions of the beam have been predetermined from other considerations and the design moment exceeds the moment of resistance of a singly reinforced section. The additional moment of resistance needed is obtained by providing compression reinforcement and additional tensile reinforcement. The moment of resistance of a doubly reinforced section is thus the sum of the limiting moment of resistance  $M_{u,lim}$  of a singly reinforced section and the additional moment of resistance  $M_{u2}$ . Given the values of  $M_u$  which is greater than  $M_{u,lim}$ , the value of  $M_{u2}$  can be calculated.

$$M_{u2} = M_u - M_{u,lim}$$



STRAIN DIAGRAM

FIG. 5 DOUBLY REINFORCED SECTION

The lever arm for the additional moment of resistance is equal to the distance between centroids of tension reinforcement and compression reinforcement, that is  $(d - d')$  where  $d'$  is the distance from the extreme compression fibre to the centroid of compression reinforcement. Therefore, considering the moment of resistance due to the additional tensile reinforcement and the compression reinforcement we get the following:

$$M_{u2} = A_{st2} (0.87 f_y) (d - d')$$

$$\text{also, } M_{u2} = A_{sc} (f_{sc} - f_{cc}) (d - d')$$

where

$A_{st2}$  is the area of additional tensile reinforcement,

$A_{sc}$  is the area of compression reinforcement,

$f_{sc}$  is the stress in compression reinforcement, and

$f_{cc}$  is the compressive stress in concrete at the level of the centroid of compression reinforcement.

Since the additional tensile force is balanced by the additional compressive force,

$$A_{sc} (f_{sc} - f_{cc}) = A_{st2} (0.87 f_y)$$

Any two of the above three equations may be used for finding  $A_{st2}$  and  $A_{sc}$ . The total tensile reinforcement  $A_{st}$  is given by,

$$A_{st} = p_{t,lim} \frac{bd}{100} + A_{st2}$$

It will be noticed that we need the values of  $f_{sc}$  and  $f_{cc}$  before we can calculate  $A_{sc}$ . The approach given here is meant for design of sections and not for analysing a given section. The depth of neutral axis is, therefore, taken as equal to  $x_{u,max}$ . As shown in Fig. 5, strain at the level of the compression reinforcement will be equal to  $0.0035 \left(1 - \frac{d'}{x_{u,max}}\right)$

For values of  $d'/d$  up to 0.2,  $f_{cc}$  is equal to  $0.446 f_{ck}$ ; and for mild steel reinforcement  $f_{sc}$  would be equal to the design yield stress of  $0.87 f_y$ . When the reinforcement is cold-worked bars, the design stress in compression reinforcement  $f_{sc}$  for different values of  $d'/d$  up to 0.2 will be as given in Table F.

TABLE F STRESS IN COMPRESSION REINFORCEMENT  $f_{sc}$ , N/mm<sup>2</sup> IN DOUBLY REINFORCED BEAMS WITH COLD-WORKED BARS

(Clause 2.3.2)

$f_y$ , N/mm <sup>2</sup>	$d'/d$			
	0.05	0.10	0.15	0.20
415	355	353	342	329
500	424	412	395	370

2.3.2.1  $A_{st2}$  has been plotted against  $(d - d')$  for different values of  $M_{u2}$  in Charts 19 and 20. These charts have been prepared for  $f_s = 217.5$  N/mm<sup>2</sup> and it is directly applicable for mild steel reinforcement with yield stress of 250 N/mm<sup>2</sup>. Values of  $A_{st2}$  for other grades of steel and also the values of  $A_{sc}$  can be obtained by multiplying the value read from the chart by the factors given in Table G. The multiplying factors for  $A_{sc}$ , given in this Table, are based on a value of  $f_{cc}$  corresponding to concrete grade M 20, but it can be used for all grades of concrete with little error.

TABLE G MULTIPLYING FACTORS FOR USE WITH CHARTS 19 AND 20

(Clause 2.3.2.1)

$f_y$ , N/mm <sup>2</sup>	FACTOR FOR $A_{st2}$	FACTOR FOR $A_{sc}$ FOR $d'/d$			
		0.05	0.10	0.15	0.20
250	1.00	1.04	1.04	1.04	1.04
415	0.60	0.63	0.63	0.65	0.68
500	0.50	0.52	0.54	0.56	0.60

2.3.2.2 The expression for the moment of resistance of a doubly reinforced section may also be written in the following manner:

$$M_u = M_{u,lim} + \frac{p_{t2}bd}{100} (0.87 f_y) (d - d')$$

$$\frac{M_u}{bd^2} = \frac{M_{u,lim}}{bd^2} + \frac{p_{t2}}{100} (0.87 f_y) \left(1 - \frac{d'}{d}\right)$$

where

$p_{t2}$  is the additional percentage of tensile reinforcement.

$$p_t = p_{t,lim} + p_{t2}$$

$$p_c = p_{t2} \left[ \frac{0.87 f_y}{f_{sc} - f_{cc}} \right]$$

The values of  $p_t$  and  $p_c$  for four values of  $d'/d$  up to 0.2 have been tabulated against  $M_u/bd^2$  in Tables 45 to 56. Tables are given for three grades of steel and four grades of concrete.

### Example 3 Doubly Reinforced Beam

Determine the main reinforcements required for a rectangular beam section with the following data:

Size of beam	30 × 60 cm
Concrete mix	M 15
Characteristic strength of reinforcement	415 N/mm <sup>2</sup>
Factored moment	320 kN.m

Assuming 25 mm dia bars with 25 mm clear cover,

$$d = 60 - 2.5 - \frac{2.5}{2} = 56.25 \text{ cm}$$

From Table D, for  $f_y = 415$  N/mm<sup>2</sup> and  $f_{ck} = 15$  N/mm<sup>2</sup>

$$M_{u,lim}/bd^2 = 2.07 \text{ N/mm}^2 = 2.07 \times 10^3 \text{ kN/m}^2$$

$$\therefore M_{u,lim} = 2.07 \times 10^3 bd^2$$

$$= 2.07 \times 10^3 \times \frac{30}{100} \times \frac{56.25}{100} \times \frac{56.25}{100}$$

$$= 196.5 \text{ kN.m}$$

Actual moment of 320 kN.m is greater than  $M_{u,lim}$

$\therefore$  The section is to be designed as a doubly reinforced section.

Reinforcement from Tables

$$\frac{M_u}{bd^2} = \frac{320}{0.3 \times (0.5625)^2 \times 10^8} = 3.37 \text{ N/mm}^2$$

$$d'/d = \left( \frac{2.5 + 1.25}{56.25} \right) = 0.07$$

Next higher value of  $d'/d = 0.1$  will be used for referring to Tables.

Referring to Table 49 corresponding to

$$M_u/bd^2 = 3.37 \text{ and } \frac{d'}{d} = 0.1,$$

$$p_t = 1.117, p_c = 0.418$$

$$\therefore A_{st} = 18.85 \text{ cm}^2, A_{sc} = 7.05 \text{ cm}^2$$

REINFORCEMENT FROM CHARTS

$$(d - d') = (56.25 - 3.75) = 52.5 \text{ cm}$$

$$M_{u2} = (320 - 196.5) = 123.5 \text{ kN.m}$$

Chart is given only for  $f_y = 250$  N/mm<sup>2</sup>; therefore use Chart 20 and modification factors according to Table G.

Referring to Chart 20,

$$A_{st2} \text{ (for } f_y = 250 \text{ N/mm}^2) = 10.7 \text{ cm}^2$$

Using modification factors given in Table G for  $f_y = 415 \text{ N/mm}^2$ ,

$$A_{skc} = 10.7 \times 0.60 = 6.42 \text{ cm}^2$$

$$A_{sc} = 10.7 \times 0.63 = 6.74 \text{ cm}^2$$

Referring to Table E,

$$p_{t,lim} = 0.72$$

$$\therefore A_{st,lim} = 0.72 \times \frac{56.25 \times 30}{100} = 12.15 \text{ cm}^2$$

$$A_{st} = 12.15 + 6.42 = 18.57 \text{ cm}^2$$

These values of  $A_{st}$  and  $A_{sc}$  are comparable to the values obtained from the table.

## 2.4 T-SECTIONS

The moment of resistance of a T-beam can be considered as the sum of the moment of resistance of the concrete in the web of width  $b_w$  and the contribution due to flanges of width  $b_f$ .

The maximum moment of resistance is obtained when the depth of neutral axis is  $x_{u,max}$ . When the thickness of flange is small, that is, less than about  $0.2 d$ , the stress in the flange will be uniform or nearly uniform (see Fig. 6) and the centroid of the compressive force in the flange can be taken at  $D_f/2$  from the extreme compression fibre. Therefore, the following expression is obtained for the limiting moment of resistance of T-beams with small values of  $D_f/d$ .

$$M_{u,lim,T} = M_{u,lim,web} + 0.446 f_{ck} \times (b_f - b_w) D_f \left( d - \frac{d_f}{2} \right)$$

where  $M_{u,lim,web}$

$$= 0.36 f_{ck} b_w x_{u,max} (d - 0.416 x_{u,max}).$$

The equation given in E-2.2 of the Code is the same as above, with the numericals rounded off to two decimals. When the flange thickness is greater than about  $0.2 d$ , the above expression is not correct because the stress

distribution in the flange would not be uniform. The expression given in E-2.2.1 of the Code is an approximation which makes allowance for the variation of stress in the flange. This expression is obtained by substituting  $y_f$  for  $D_f$  in the equation of E-2.2 of the Code;  $y_f$  being equal to  $(0.15 x_{u,max} + 0.65 D_f)$  but not greater than  $D_f$ . With this modification,

$$M_{u,lim,T} = M_{u,lim,web} + 0.446 f_{ck} \times (b_f - b_w) y_f \left( d - \frac{y_f}{2} \right)$$

Dividing both sides by  $f_{ck} b_w d^2$ ,

$$\frac{M_{u,lim,T}}{f_{ck} b_w d^2} = \frac{M_{u,lim,web}}{f_{ck} b_w d^2} + 0.446 \times \left( \frac{b_f}{b_w} - 1 \right) \frac{y_f}{d} \left( 1 - \frac{y_f}{2d} \right)$$

where

$$\frac{y_f}{d} = 0.15 \frac{x_{u,max}}{d} + 0.65 \frac{D_f}{d}$$

$$\text{but } \frac{y_f}{d} \leq \frac{D_f}{d}$$

Using the above expression, the values of the moment of resistance factor  $M_{u,lim,T}/f_{ck} b_w d^2$  for different values of  $b_f/b_w$  and  $D_f/d$  have been worked out and given in Tables 57 to 59 for three grades of steel.

## 2.5 CONTROL OF DEFLECTION

2.5.1 The deflection of beams and slabs would generally be within permissible limits if the ratio of span to effective depth of the member does not exceed the values obtained in accordance with 22.2.1 of the Code. The following basic values of span to effective depth are given:

Simply supported	20
Continuous	26
Cantilever	7

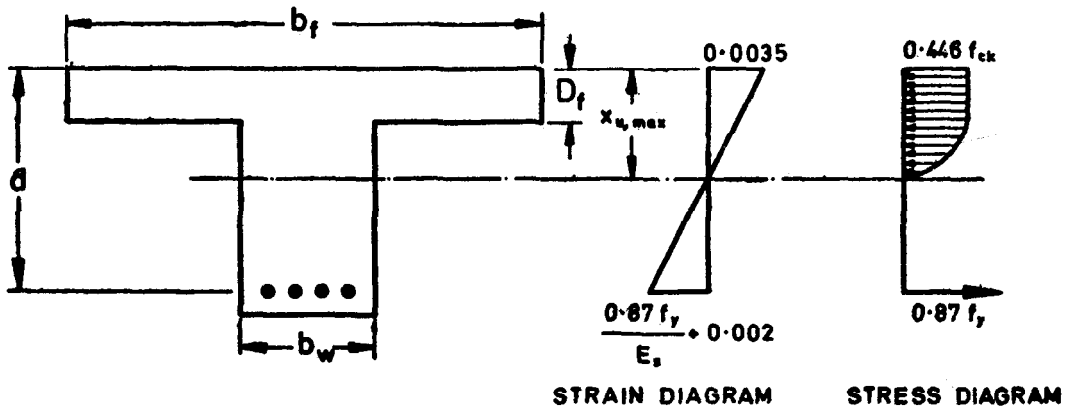


FIG. 6 T-SECTION

Further modifying factors are given in order to account for the effects of grade and percentage of tension reinforcement and percentage of compression reinforcement.

2.5.2 In normal designs where the reinforcement provided is equal to that required from strength considerations, the basic values of span to effective depth can be multiplied by the appropriate values of the modifying factors and given in a form suitable for direct reference. Such charts have been prepared as explained below:

- a) The basic span to effective depth ratio for simply supported members is multiplied by the modifying factor for tension reinforcement (Fig. 3 of the Code) and plotted as the base curve in the chart. A separate chart is drawn for each grade of steel. In the chart, span to effective depth ratio is plotted on the vertical axis and the tensile reinforcement percentage is plotted on the horizontal axis.
- b) When the tensile reinforcement exceeds  $p_{t,lim}$  the section will be doubly reinforced. The percentage of compression reinforcement is proportional to the additional tensile reinforcement ( $p_t - p_{t,lim}$ ) as explained in 2.3.2. However, the value of  $p_{t,lim}$  and  $p_c$  will depend on the grade of concrete also. Therefore, the values of span to effective depth ratio according to base curve is modified as follows for each grade of concrete:

- 1) For values of  $p_t$  greater than the appropriate value of  $p_{t,lim}$ , the value of  $(p_t - p_{t,lim})$  is calculated and then the percentage of compression reinforcement  $p_c$  required is calculated. Thus, the value of  $p_c$  corresponding to a value of  $p_t$  is obtained. (For this purpose  $d'/d$  has been assumed as 0.10 but the chart, thus obtained can generally be used for all values of  $d'/d$  in the normal range, without significant error in the value of maximum span to effective depth ratio.)
- 2) The value of span to effective depth ratio of the base curve is multiplied by the modifying factor for compression reinforcement from Fig. 4 of the Code.
- 3) The value obtained above is plotted on the same Chart in which the base curve was drawn earlier. Hence the span to effective depth ratio for doubly reinforced section is plotted against the tensile reinforcement percentage  $p_t$  without specifically indicating the value of  $p_c$  on the Chart.

2.5.3 The values read from these Charts are directly applicable for simply supported members of rectangular cross section for spans up to 10 m. For simply supported or continuous spans larger than 10 m, the values should be further multiplied by the factor (10/span in metres). For continuous spans or cantilevers, the values read from the charts are to be modified in proportion to the basic values of span to effective depth ratio. The multiplying factors for this purpose are as follows:

Continuous spans	1.3
Cantilevers	0.35

In the case of cantilevers which are longer than 10 m the Code recommends that the deflections should be calculated in order to ensure that they do not exceed permissible limits.

2.5.4 For flanged beams, the Code recommends that the values of span to effective depth ratios may be determined as for rectangular sections, subject to the following modifications:

- a) The reinforcement percentage should be based on the area  $b_f d$  while referring the charts.
- b) The value of span to effective depth ratio obtained as explained earlier should be reduced by multiplying by the following factors:

$b_f/b_w$	Factor
1.0	1.0
>3.33	0.8

For intermediate values, linear interpolation may be done.

NOTE — The above method for flanged beams may sometimes give anomalous results. If the flanges are ignored and the beam is considered as a rectangular section, the value of span to effective depth ratio thus obtained (percentage of reinforcement being based on the area  $b_w d$ ) should always be on the safe side.

2.5.5 In the case of two way slabs supported on all four sides, the shorter span should be considered for the purpose of calculating the span to effective depth ratio (see Note 1 below 23.1 of the Code).

2.5.6 In the case of flat slabs the longer span should be considered (30.2.1 of the Code). When drop panels conforming to 30.2.2 of the Code are not provided, the values of span to effective depth ratio obtained from the Charts should be multiplied by 0.9.

#### Example 4 Control of Deflection

Check whether the depth of the member in the following cases is adequate for controlling deflection:

- a) Beam of Example 1, as a simply supported beam over a span of 7.5 m

- b) Beam of Example 3, as a cantilever beam over a span of 4.0 m
- c) Slab of Example 2, as a continuous slab spanning in two directions the shorter and longer spans being, 2.5 m and 3.5 m respectively. The moment given in Example 2 corresponds to shorter span.

a) Actual ratio of  $\frac{\text{Span}}{\text{Effective depth}}$

$$= \frac{7.5}{(56.25/100)} = 13.33$$

Percentage of tension reinforcement required,

$$p_t = 0.6$$

Referring to Chart 22, value of  $\text{Max} \left( \frac{\text{Span}}{d} \right)$  corresponding to  $p_t = 0.6$ , is 22.2.

Actual ratio of span to effective depth is less than the allowable value. Hence the depth provided is adequate for controlling deflection.

b) Actual ratio of  $\frac{\text{Span}}{\text{Effective depth}}$

$$= \left( \frac{4.0}{56.25/100} \right) = 7.11$$

Percentage of tensile reinforcement,  $p_t = 1.117$

Referring to Chart 22,

$$\text{Max value of } \left( \frac{\text{Span}}{d} \right) = 21.0$$

For cantilevers, values read from the Chart are to be multiplied by 0.35.

$$\therefore \left. \begin{array}{l} \text{Max value of} \\ l/d \text{ for} \\ \text{cantilever} \end{array} \right\} = 21.0 \times 0.35 = 7.35$$

$\therefore$  The section is satisfactory for control of deflection.

c) Actual ratio of  $\frac{\text{Span}}{\text{Effective depth}}$

$$= \frac{2.5}{0.08} = 31.25$$

(for slabs spanning in two directions, the shorter of the two is to be considered)

(i) For  $f_y = 415 \text{ N/mm}^2$   
 $p_t = 0.475$

Referring to Chart 22,

$$\text{Max} \left( \frac{\text{Span}}{d} \right) = 23.6$$

For continuous slabs the factor obtained from the Chart should be multiplied by 1.3.

$$\therefore \text{Max} \frac{\text{Span}}{d} \text{ for continuous slab} \\ = 23.6 \times 1.3 = 30.68$$

Actual ratio of span to effective depth is slightly greater than the allowable. Therefore the section may be slightly modified or actual deflection calculations may be made to ascertain whether it is within permissible limits.

(ii) For  $f_y = 250 \text{ N/mm}^2$   
 $p_t = 0.78$

Referring to Chart 21,

$$\text{Max} \left( \frac{\text{Span}}{d} \right) = 31.3$$

$\therefore$  For continuous slab,

$$\text{Max} \frac{\text{Span}}{d} = 31.3 \times 1.3 = 40.69$$

Actual ratio of span to effective depth is less than the allowable value. Hence the section provided is adequate for controlling deflection.

$f_y$   
250

$f_{ck}$   
15

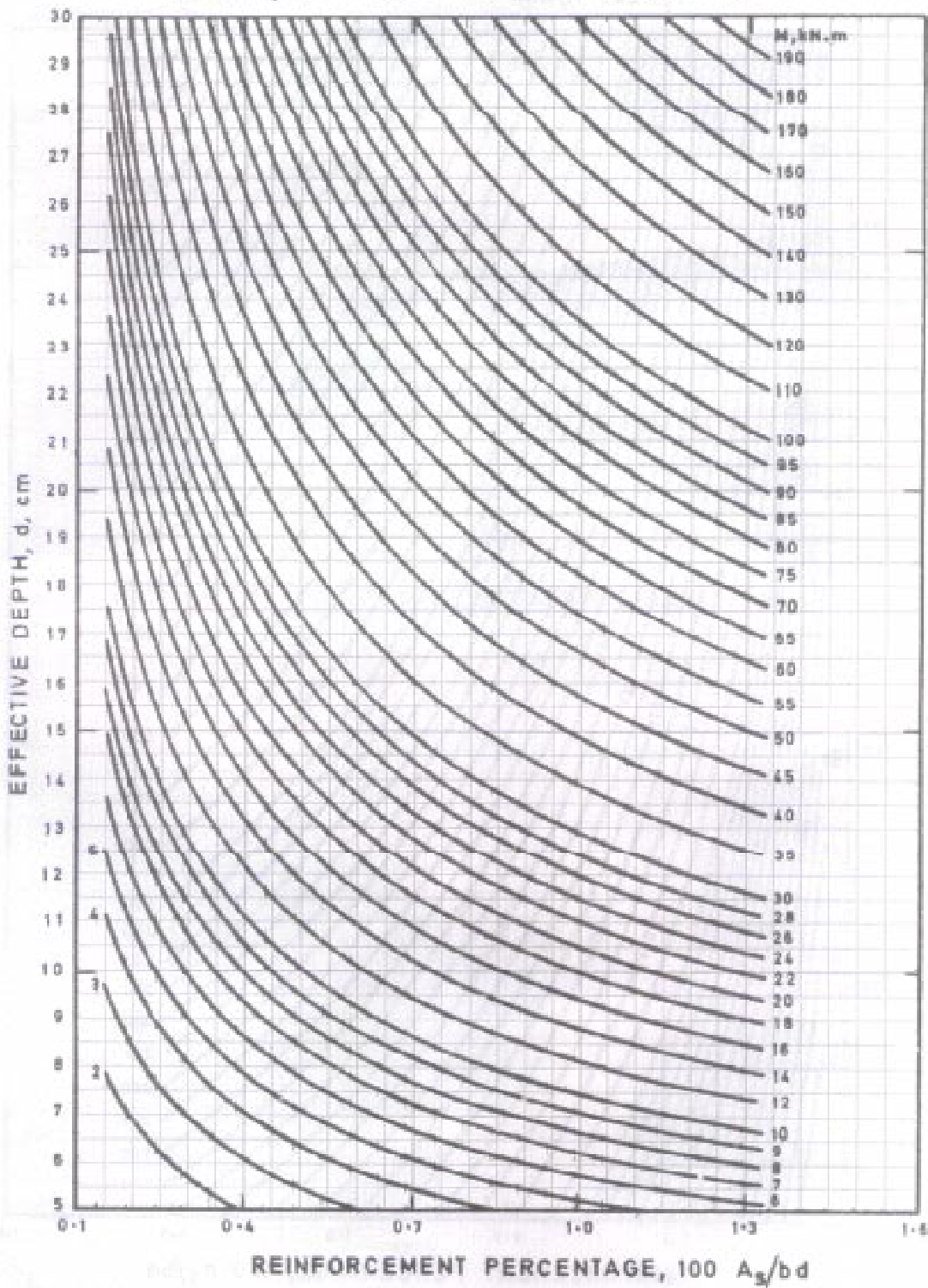
$d$   
5-30

### Chart 1 FLEXURE — Singly Reinforced Section

Moment of Resistance kN.m per Metre Width

$f_y = 250 \text{ N/mm}^2$

$f_{ck} = 15 \text{ N/mm}^2$



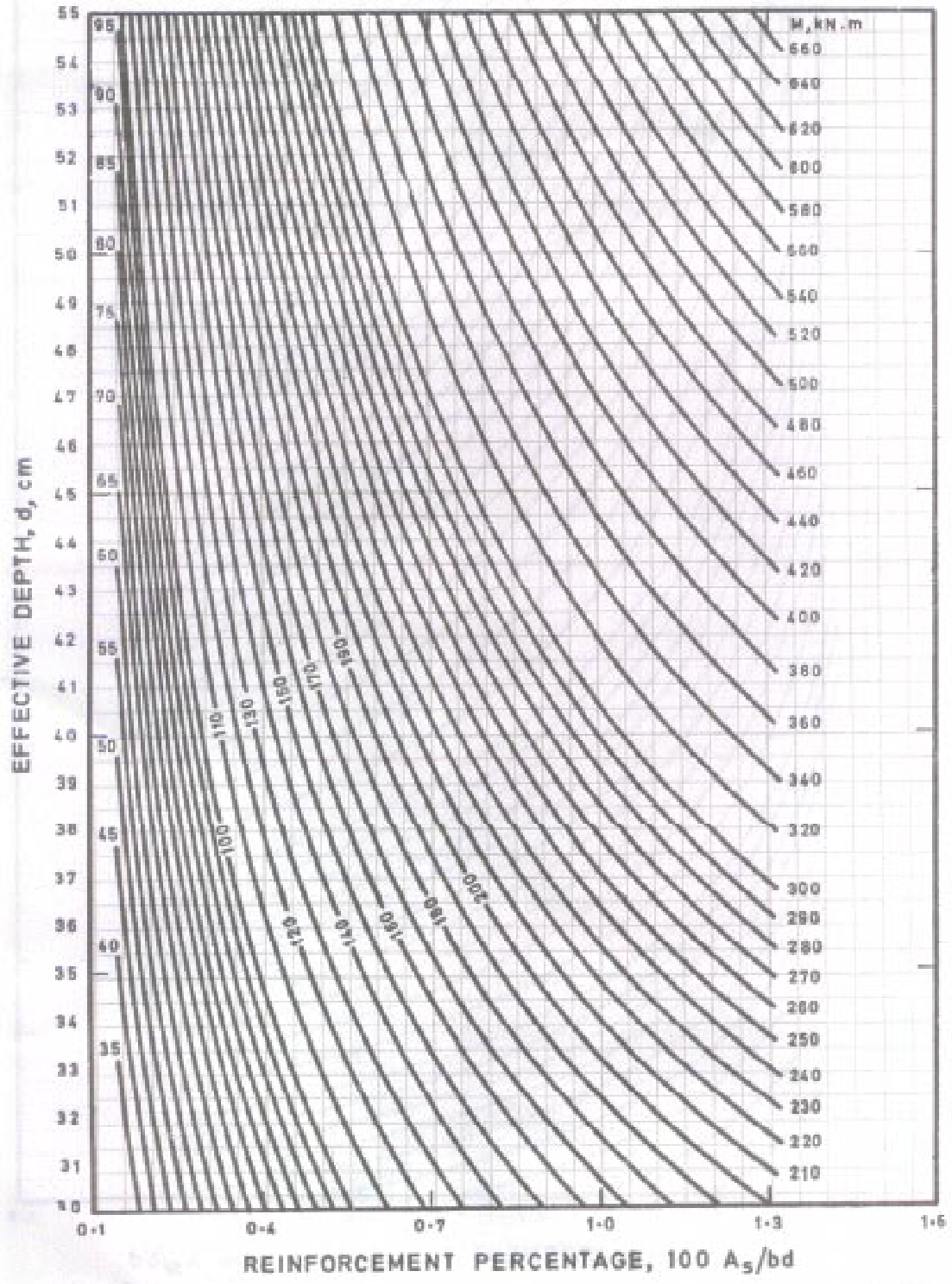


$f_y$   
250  
 $f_{ck}$   
15  
 $d$   
30-55

**Chart 2 FLEXURE — Singly Reinforced Section**  
Moment of Resistance kN.m per Metre Width

$f_y = 250 \text{ N/mm}^2$

$f_{ck} = 15 \text{ N/mm}^2$



$f_y$   
250

$f_{ck}$   
15

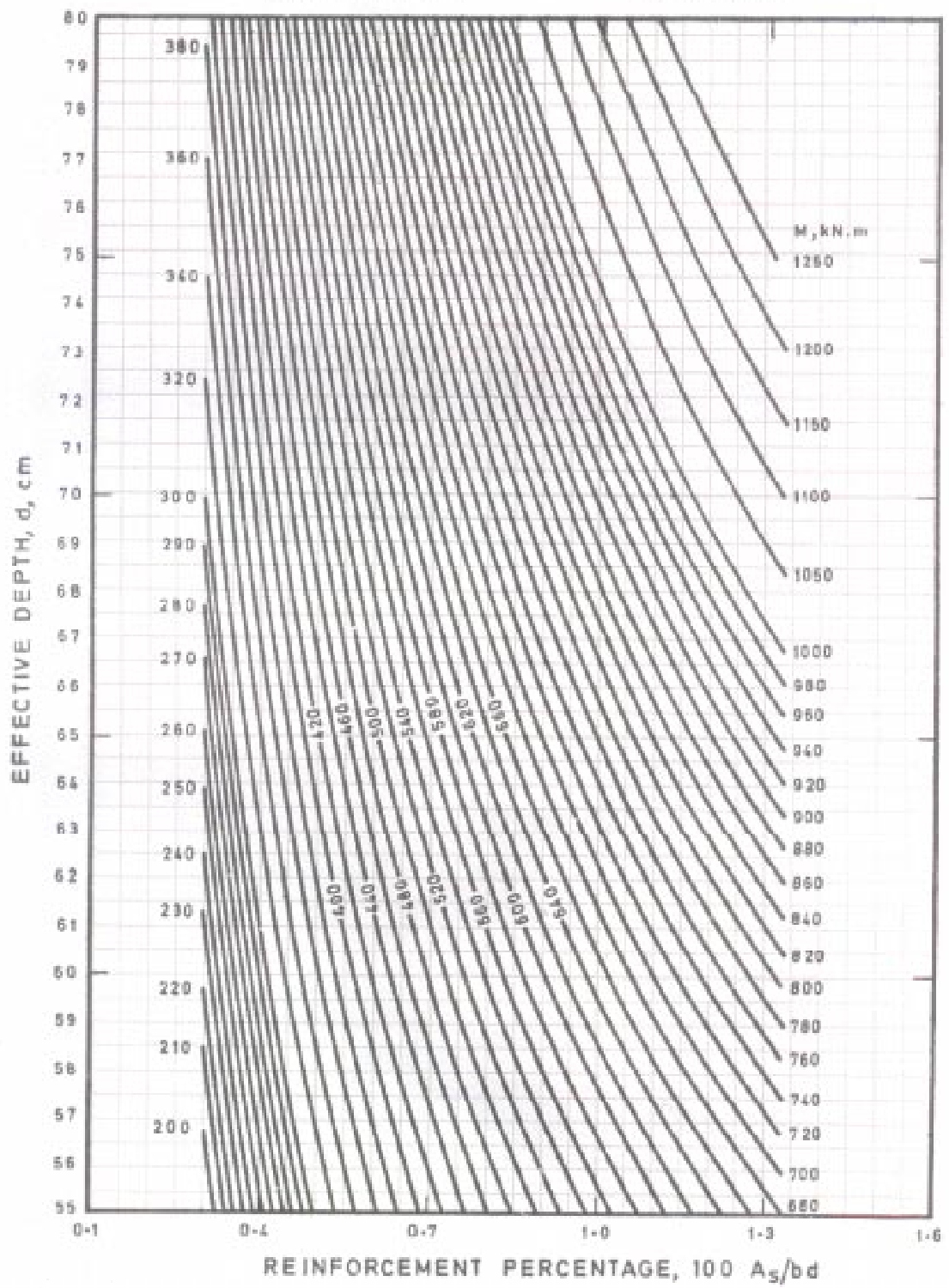
$d$   
55-80

### Chart 3 FLEXURE — Singly Reinforced Section

Moment of Resistance kN.m per Metre Width

$f_y = 250 \text{ N/mm}^2$

$f_{ck} = 15 \text{ N/mm}^2$



As in the Original Standard, this Page is Intentionally Left Blank

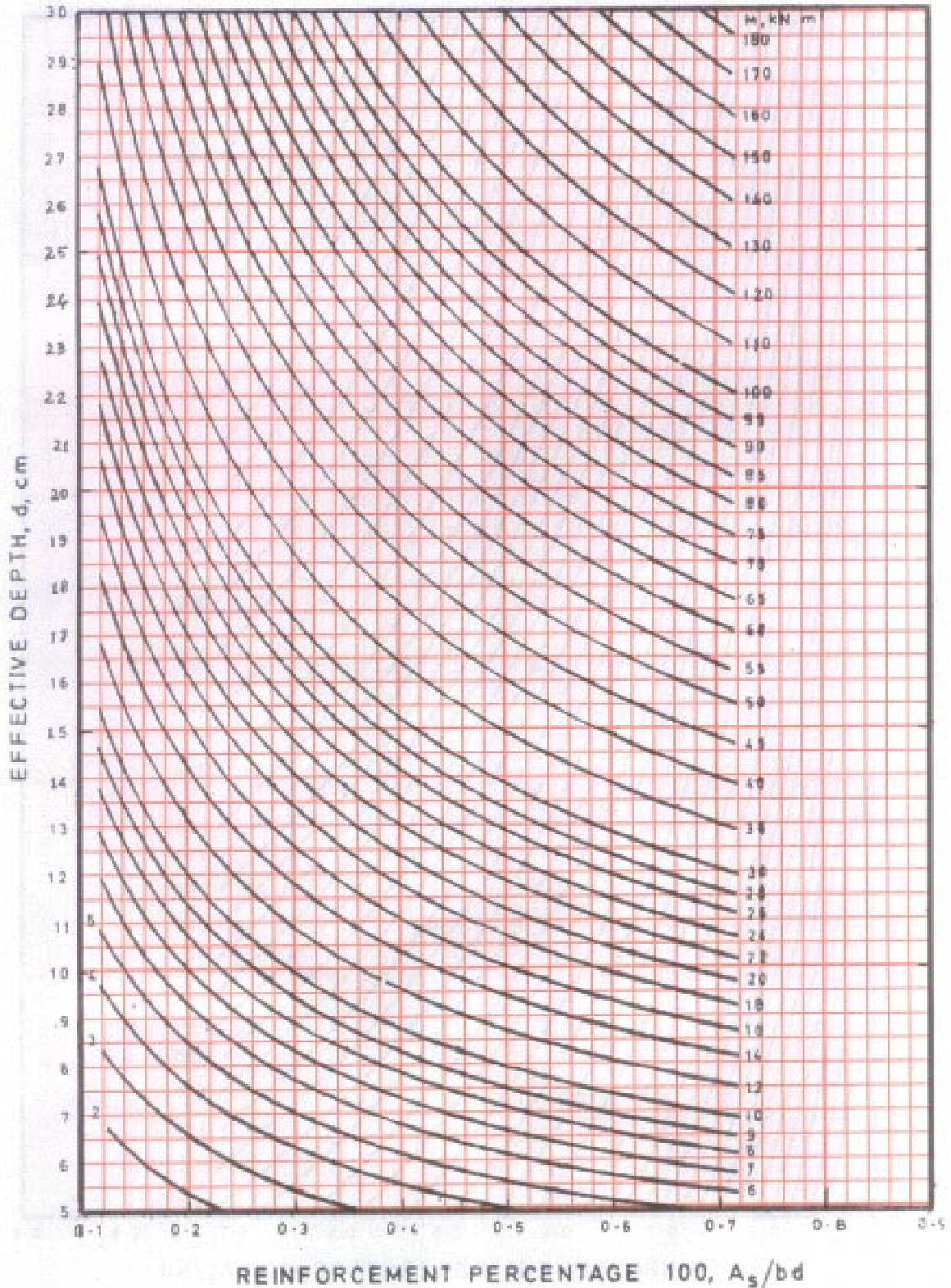
$f_y$   
415  
 $f_{ck}$   
15  
 $d$   
5-30

**Chart 4 FLEXURE — Singly Reinforced Section**

Moment of Resistance kN.m per Metre Width

$f_y = 415 \text{ N/mm}^2$

$f_{ck} = 15 \text{ N/mm}^2$



$f_y$   
415

$f_{ck}$   
15

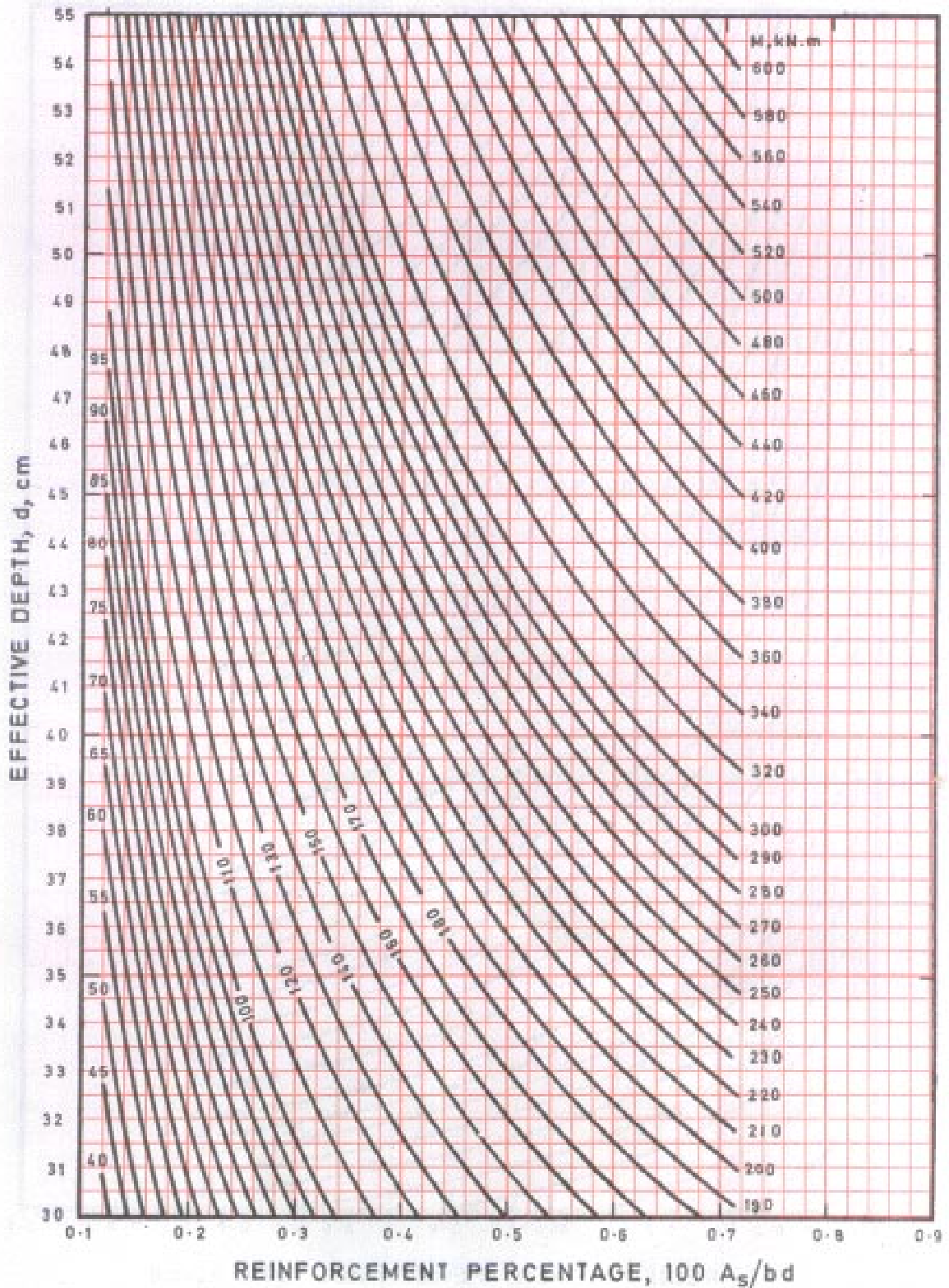
$d$   
30-55

### Chart 5 FLEXURE — Singly Reinforced Section

Moment of Resistance kN.m per Metre Width

$f_y = 415 \text{ N/mm}^2$

$f_{ck} = 15 \text{ N/mm}^2$





$f_y$   
415

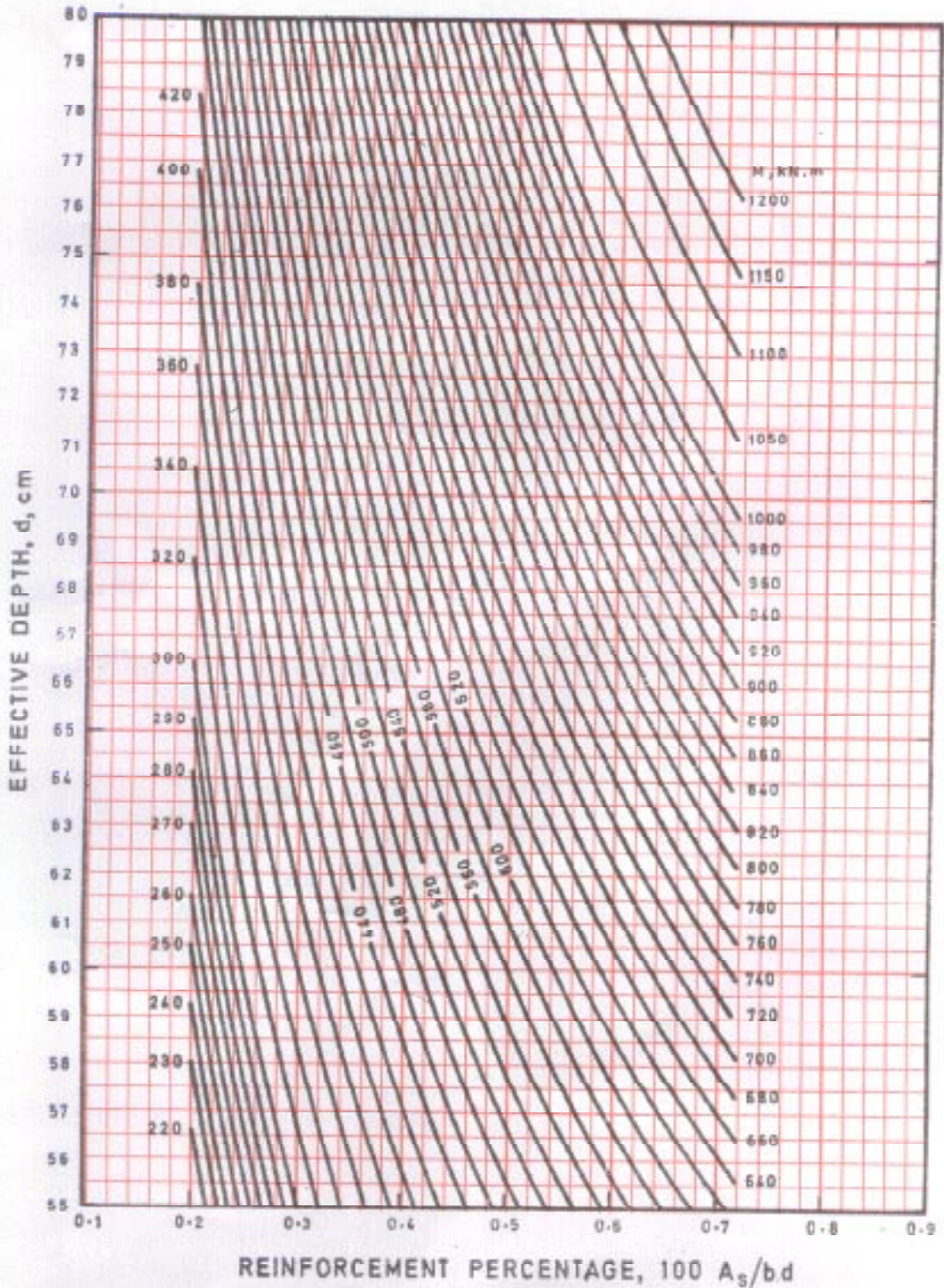
$f_{ck}$   
15

$d$   
55-80

**Chart 6 FLEXURE — Singly Reinforced Section**  
Moment of Resistance kN.m per Metre Width

$f_y = 415 \text{ N/mm}^2$

$f_{ck} = 15 \text{ N/mm}^2$



As in the Original Standard, this Page is Intentionally Left Blank

$f_y$   
500

$f_{ck}$   
15

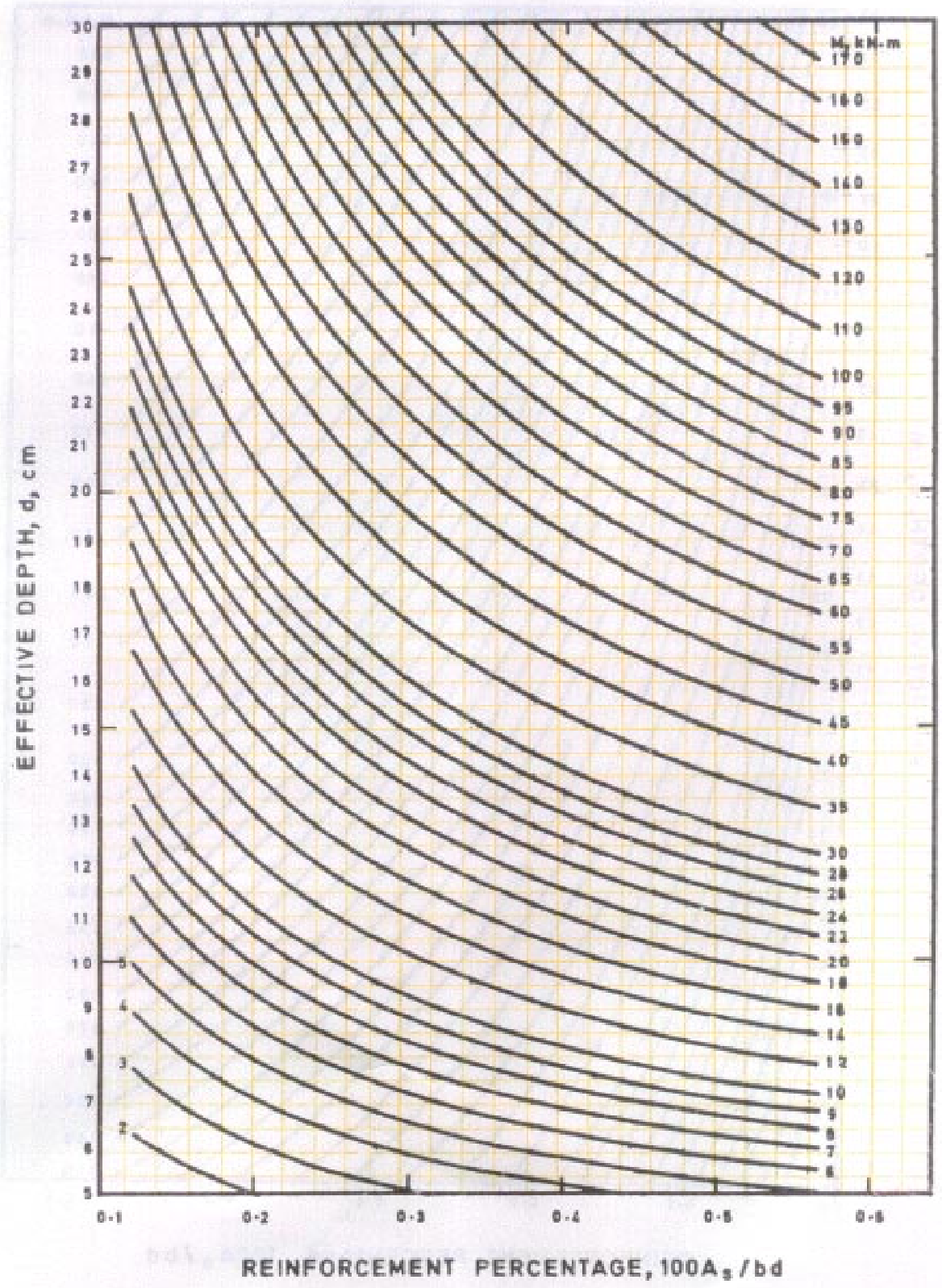
$d$   
5-30

### Chart 7 FLEXURE — Singly Reinforced Section

Moment of Resistance kN.m per Metre Width

$f_y = 500 \text{ N/mm}^2$

$f_{ck} = 15 \text{ N/mm}^2$





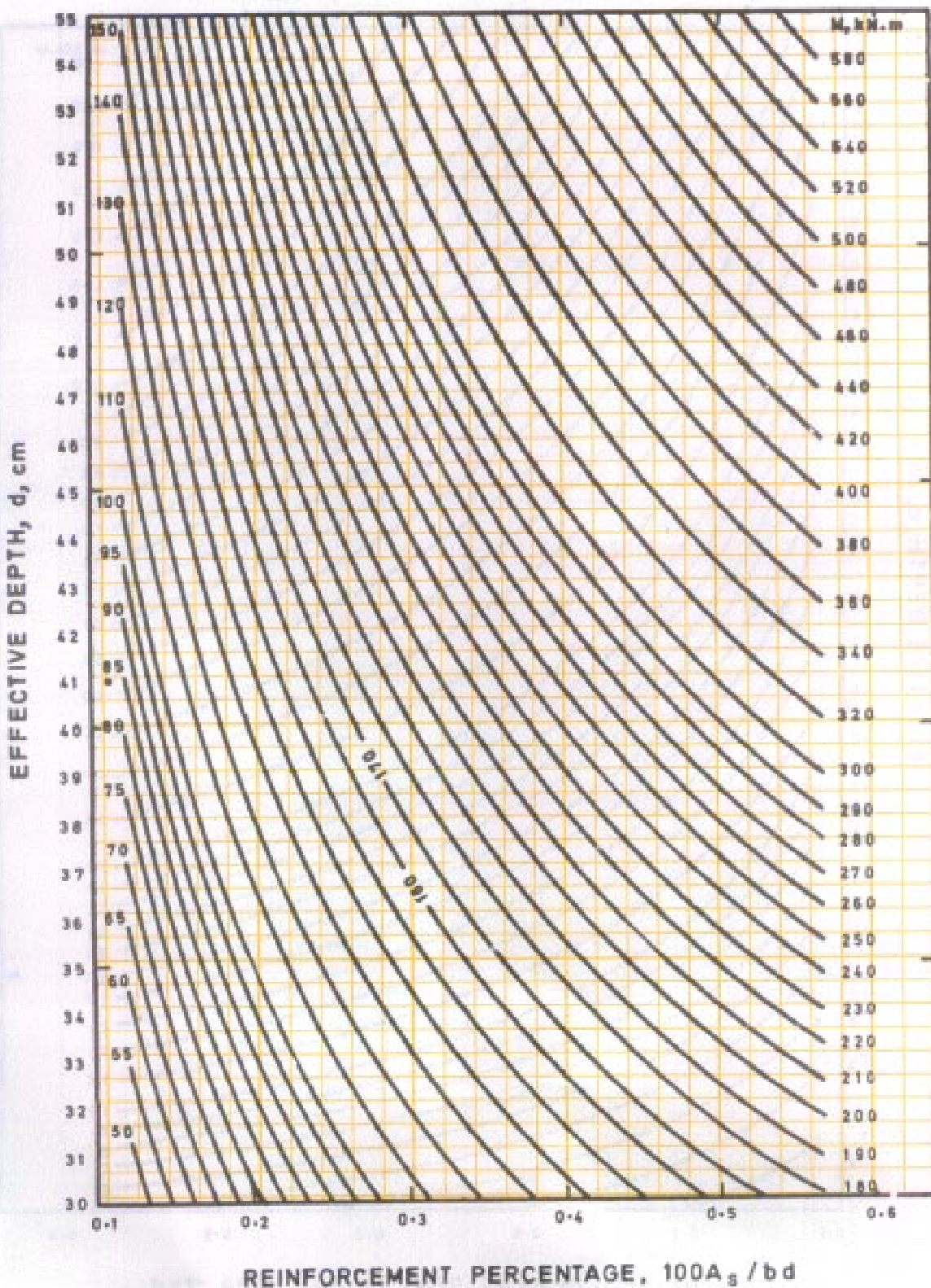
$f_y$   
**500**  
 $f_{ck}$   
**15**  
 $d$   
**30-55**

### Chart 8 FLEXURE — Singly Reinforced Section

Moment of Resistance kN.m per Metre Width

$$f_y = 500 \text{ N/mm}^2$$

$$f_{ck} = 15 \text{ N/mm}^2$$



$f_y$   
500

$f_{ck}$   
15

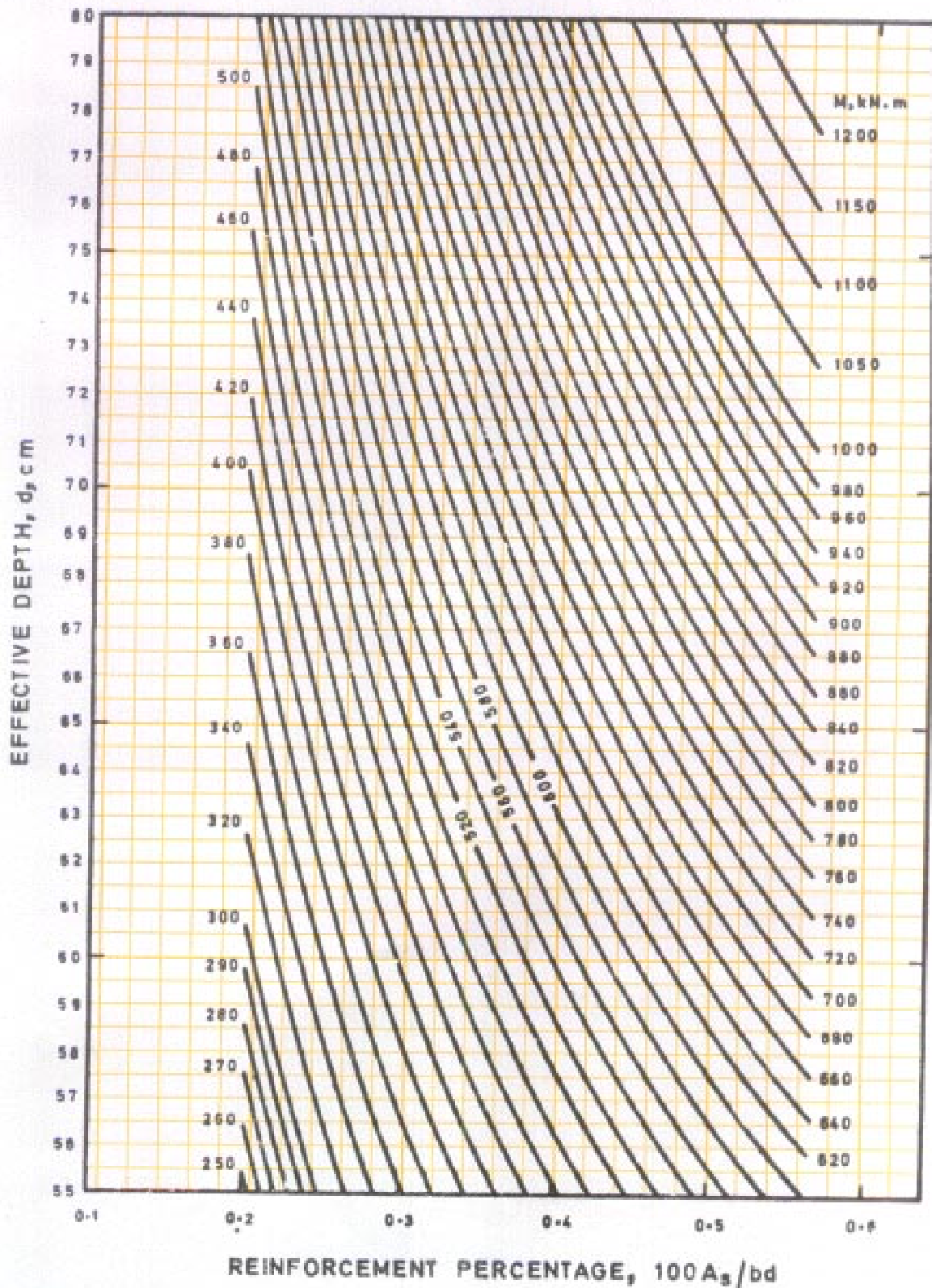
$d$   
55-80

### Chart 9 FLEXURE — Singly Reinforced Section

Moment of Resistance kN.m per Metre Width

$f_y = 500 \text{ N/mm}^2$

$f_{ck} = 15 \text{ N/mm}^2$



As in the Original Standard, this Page is Intentionally Left Blank

$f_y$   
250

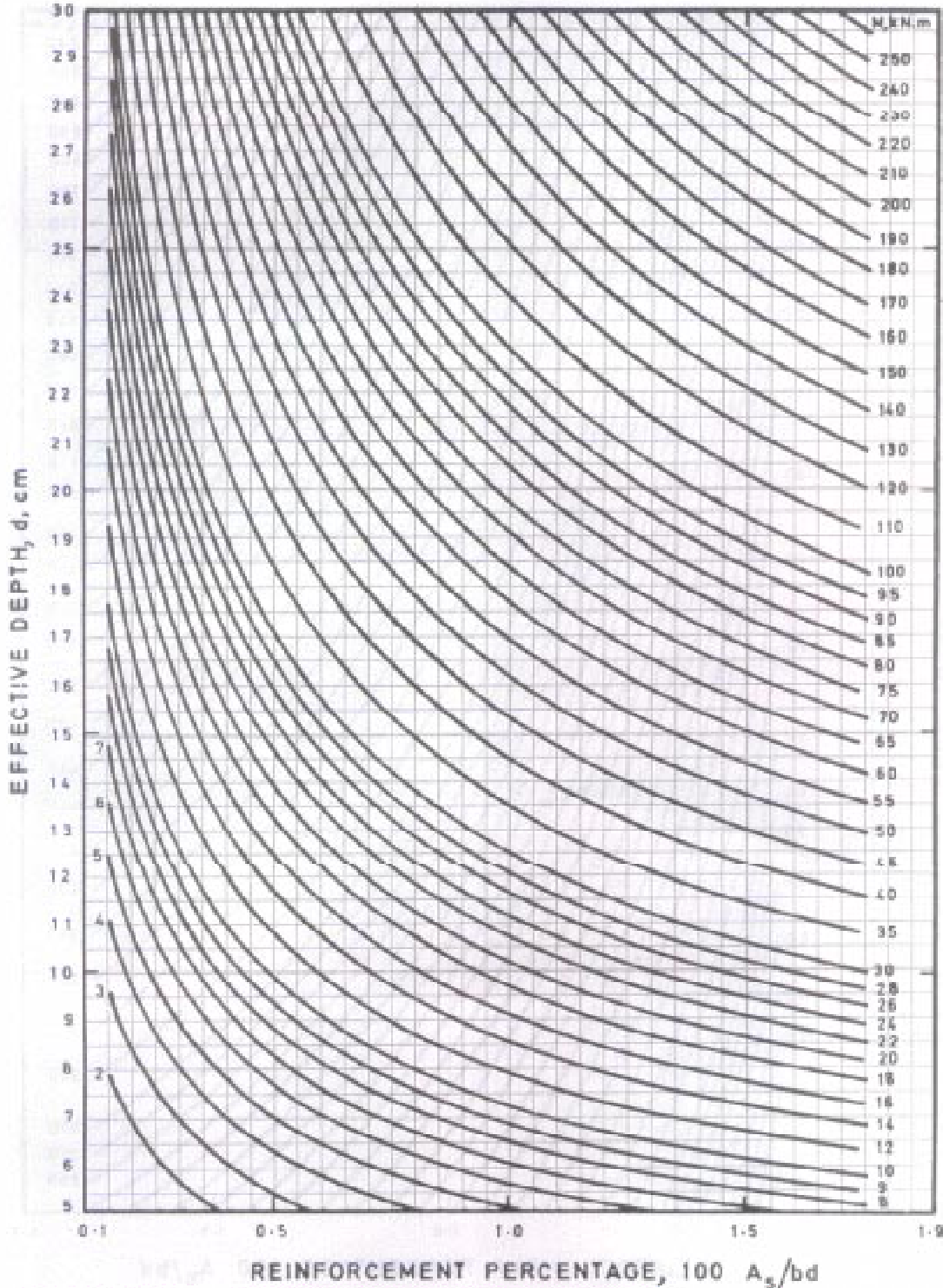
$f_{ck}$   
20

$d$   
5-30

### Chart 10 FLEXURE — Singly Reinforced Section

Moment of Resistance kN.m per Metre Width

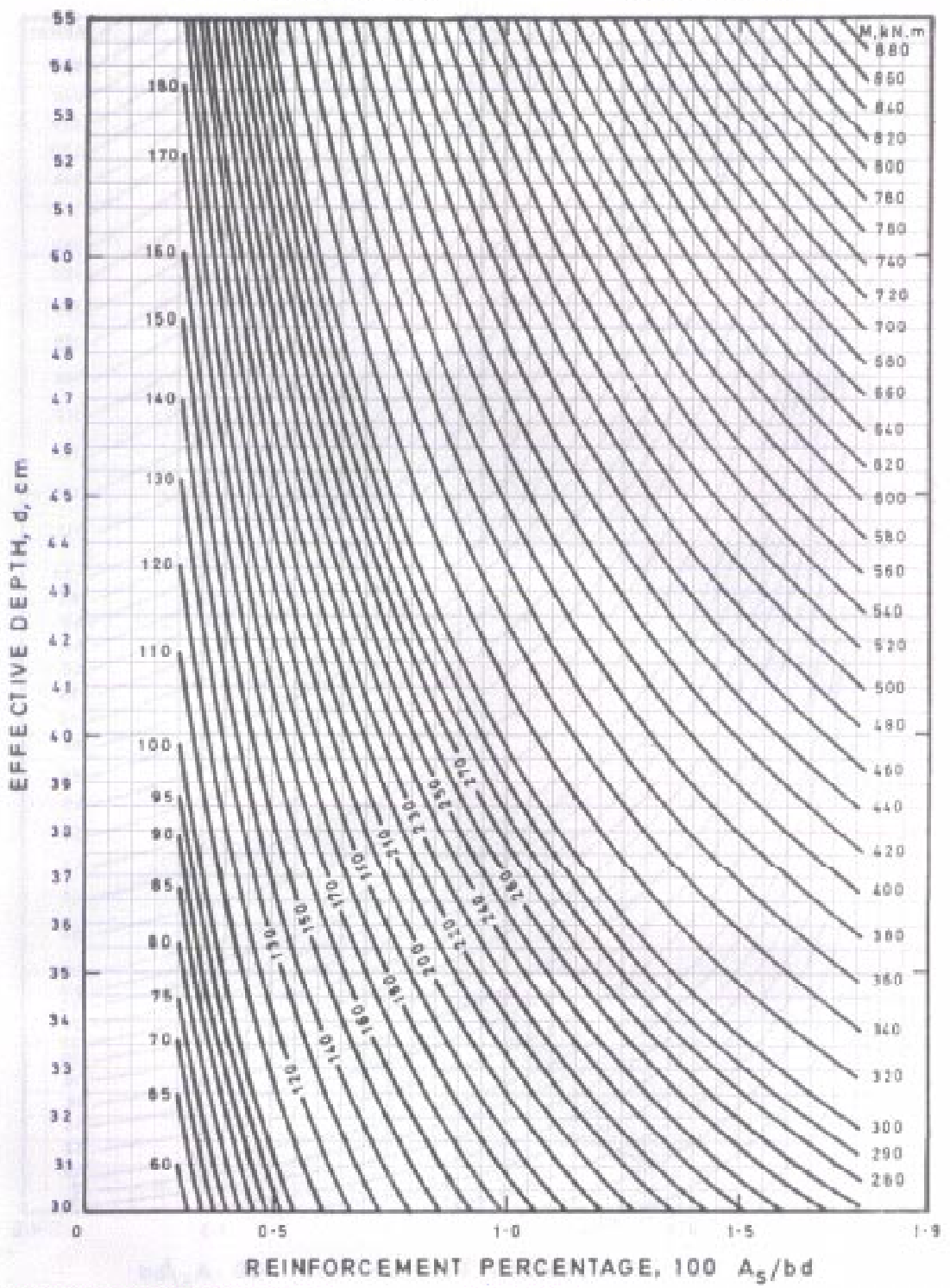
$f_y = 250 \text{ N/mm}^2$        $f_{ck} = 20 \text{ N/mm}^2$



$f_y$   
 250  
 $f_{ck}$   
 20  
 $d$   
 30-55

**Chart 11 FLEXURE — Singly Reinforced Section**  
 Moment of Resistance kN.m per Metre Width

$f_y = 250 \text{ N/mm}^2$        $f_{ck} = 20 \text{ N/mm}^2$

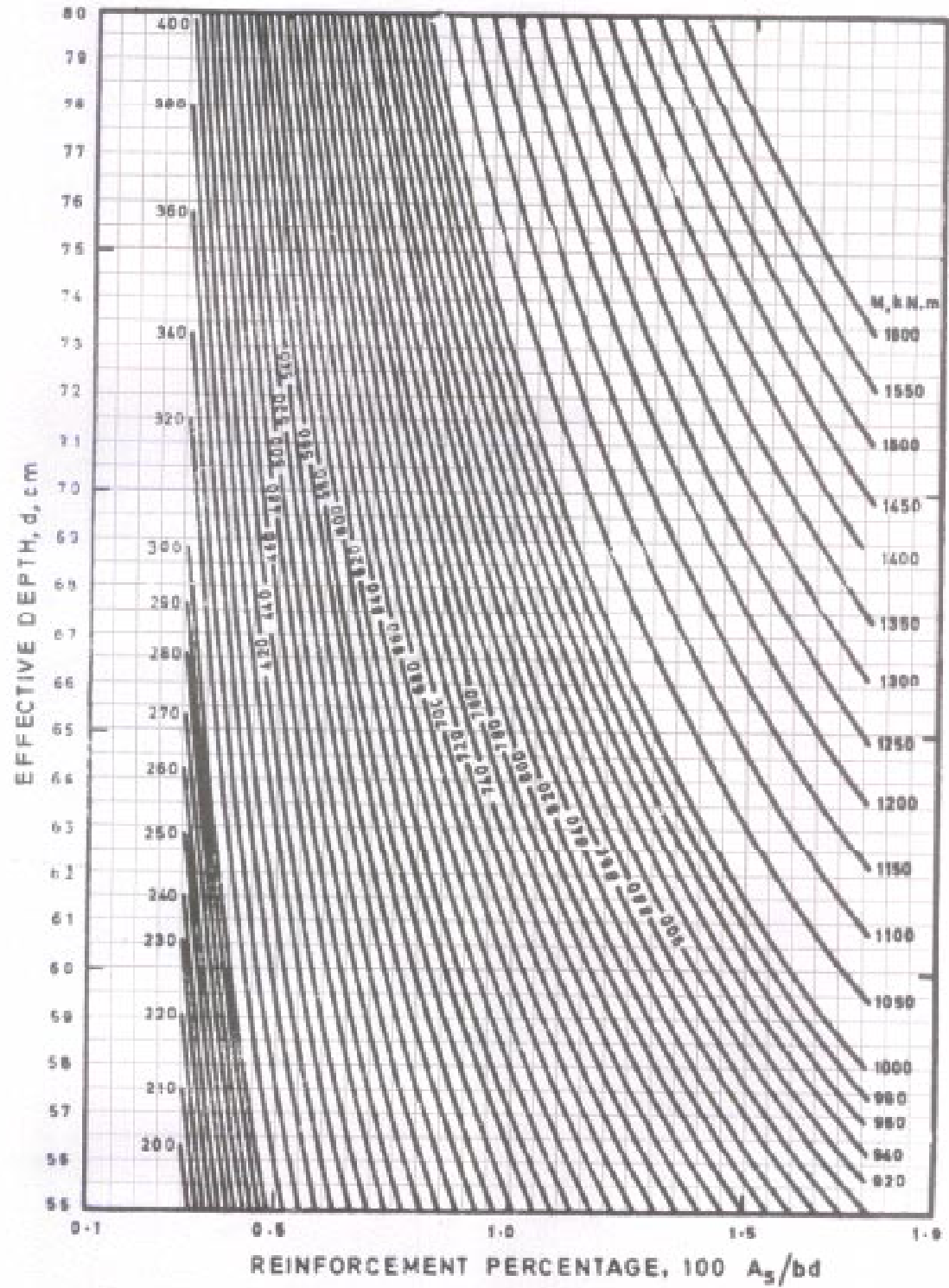


$f_y$   
 250  
 $f_{ck}$   
 20  
 $d$   
 55-80

**Chart 12 FLEXURE — Singly Reinforced Section**  
 Moment of Resistance kN.m per Metre Width

$f_y = 250 \text{ N/mm}^2$

$f_{ck} = 20 \text{ N/mm}^2$



As in the Original Standard, this Page is Intentionally Left Blank



$f_y$   
415

$f_{ck}$   
20

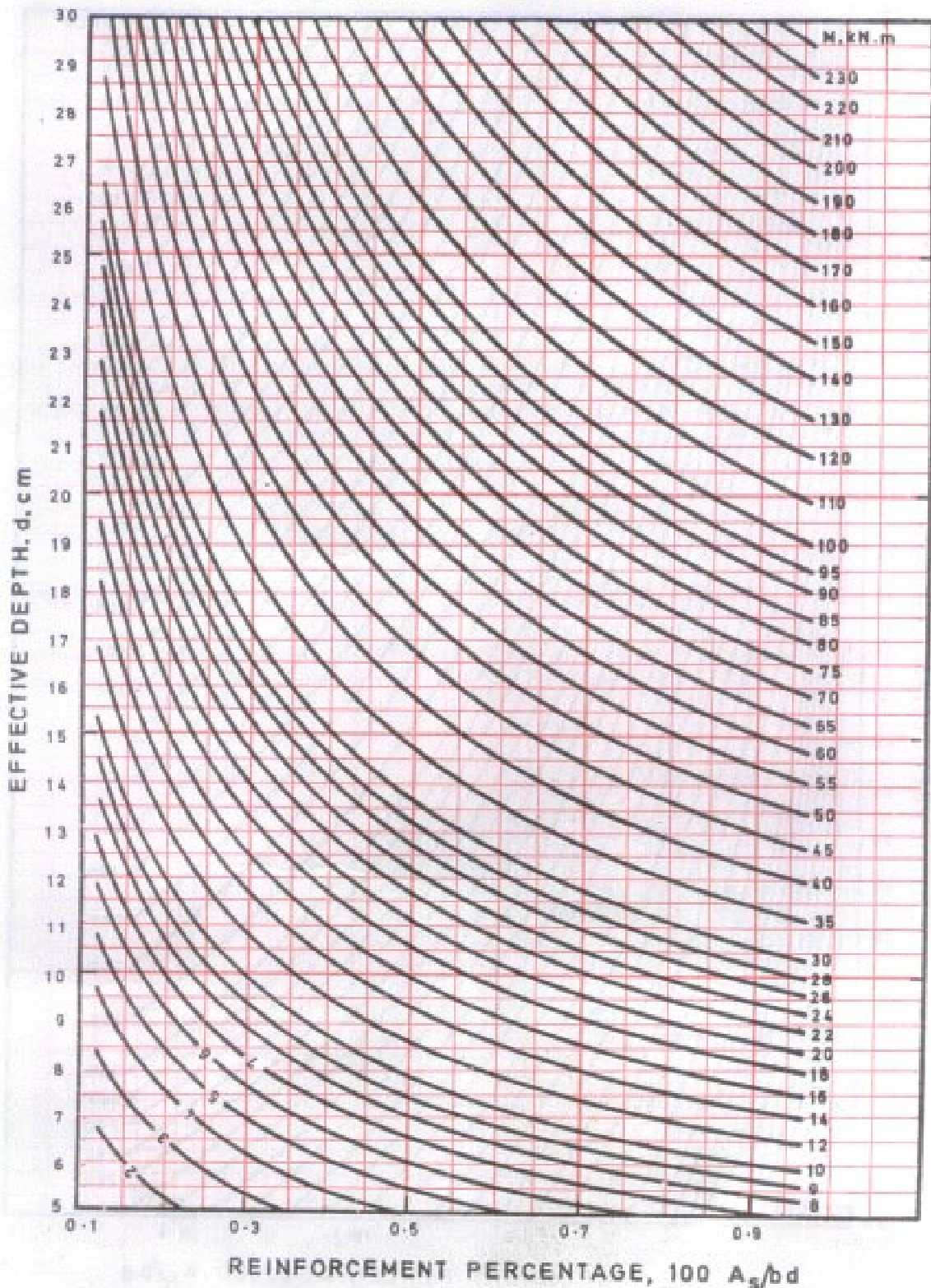
$d$   
5-30

### Chart 13 FLEXURE — Singly Reinforced Section

Moment of Resistance kN.m per Metre Width

$$f_y = 415 \text{ N/mm}^2$$

$$f_{ck} = 20 \text{ N/mm}^2$$





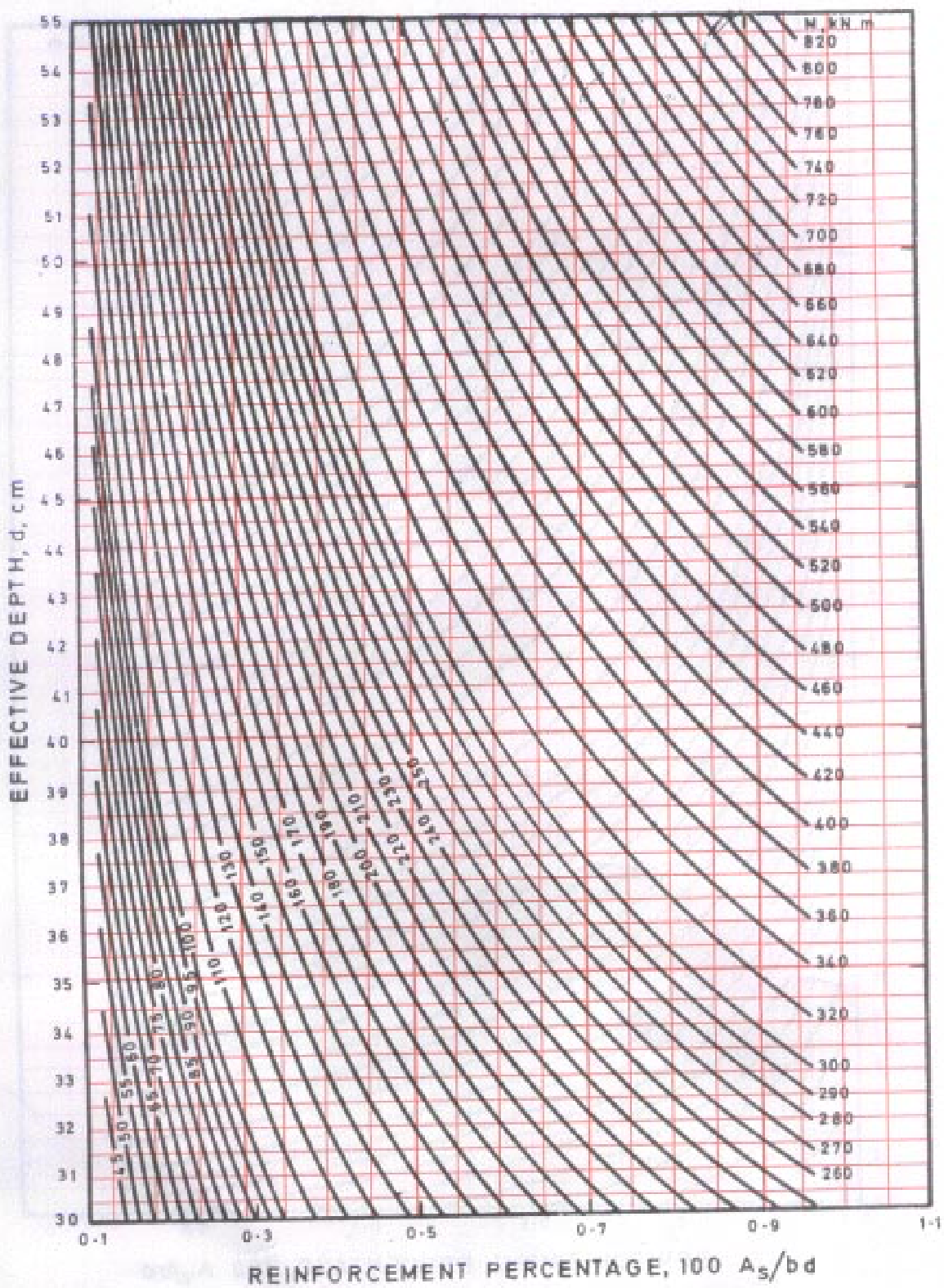
$f_y$   
415  
 $f_{ck}$   
20  
 $d$   
30-55

### Chart 14 FLEXURE — Singly Reinforced Section

Moment of Resistance kN.m per Metre Width

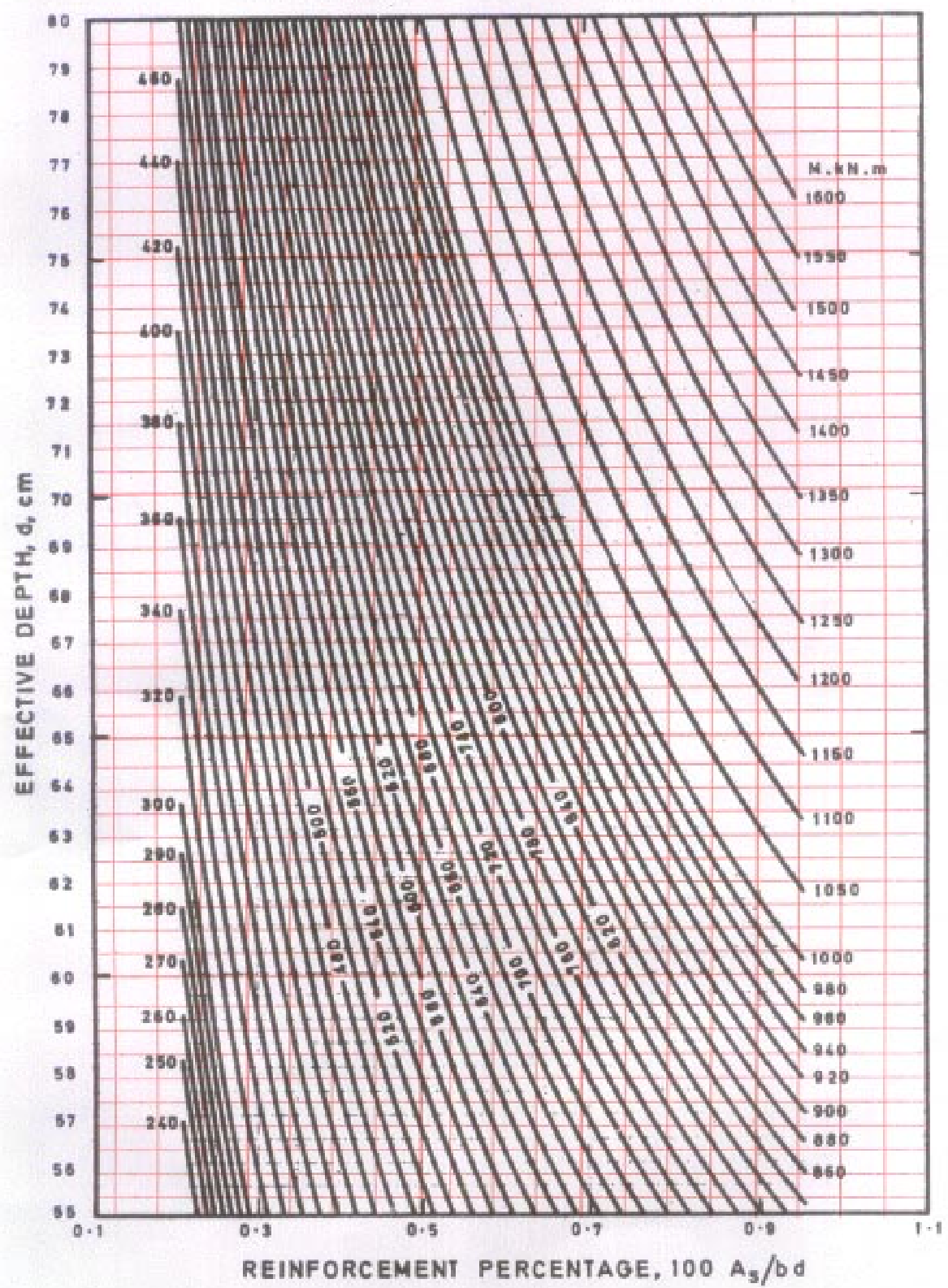
$f_y = 415 \text{ N/mm}^2$

$f_{ck} = 20 \text{ N/mm}^2$



$f_y$   
415  
 $f_{ck}$   
20  
 $d$   
55-8

**Chart 15 FLEXURE — Singly Reinforced Section**  
 Moment of Resistance kN.m per Metre Width  
 $f_y = 415 \text{ N/mm}^2$        $f_{ck} = 20 \text{ N/mm}^2$



As in the Original Standard, this Page is Intentionally Left Blank

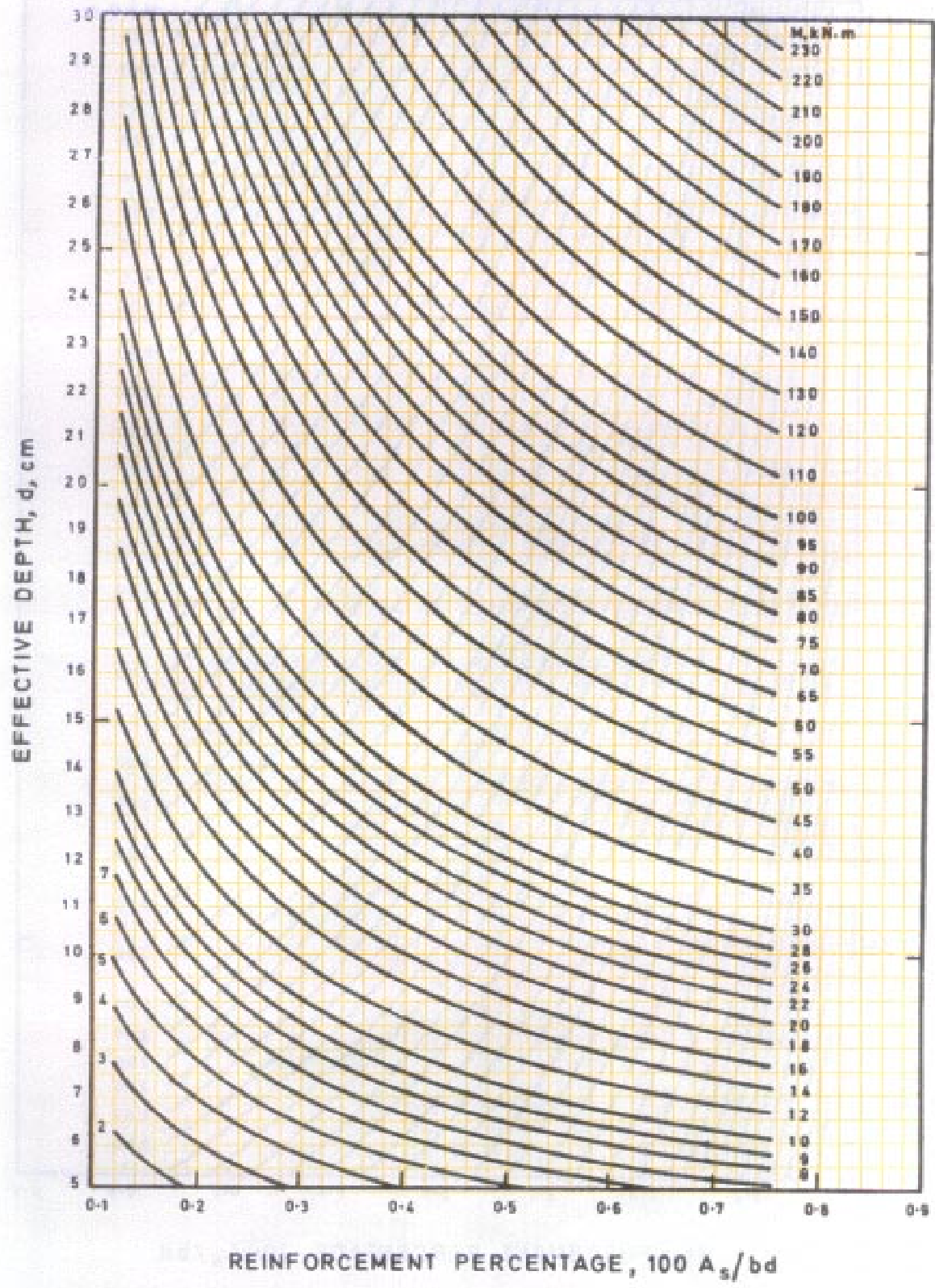
$f_y$   
500  
 $f_{ck}$   
20  
 $d$   
5-30

### Chart 16 FLEXURE — Singly Reinforced Section

Moment of Resistance kN.m per Metre Width

$f_y = 500 \text{ N/mm}^2$

$f_{ck} = 20 \text{ N/mm}^2$



$f_y$   
500

$f_{ck}$   
20

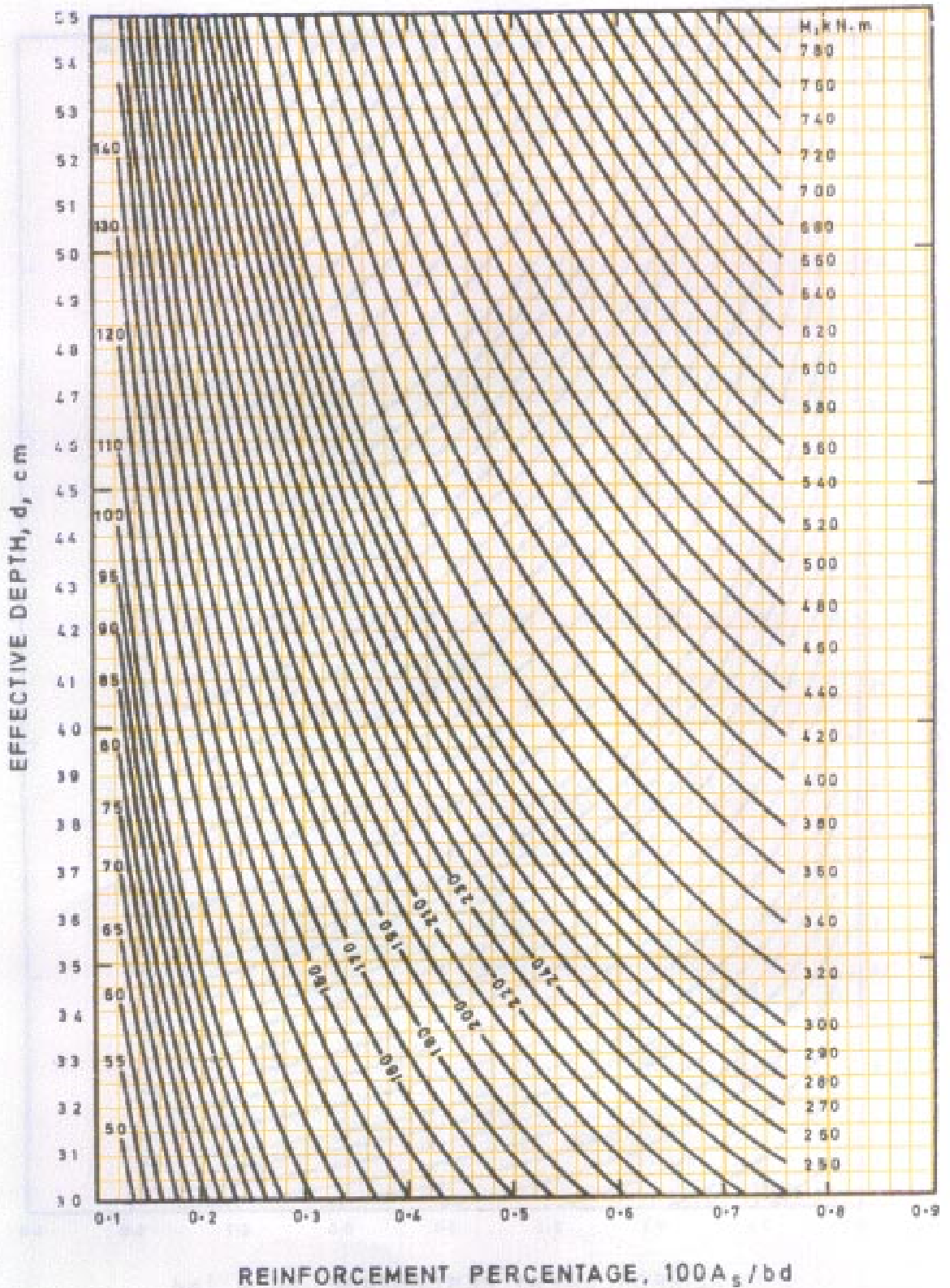
$d$   
30-55

### Chart 17 FLEXURE — Singly Reinforced Section

Moment of Resistance kN.m per Metre Width

$f_y = 500 \text{ N/mm}^2$

$f_{ck} = 20 \text{ N/mm}^2$



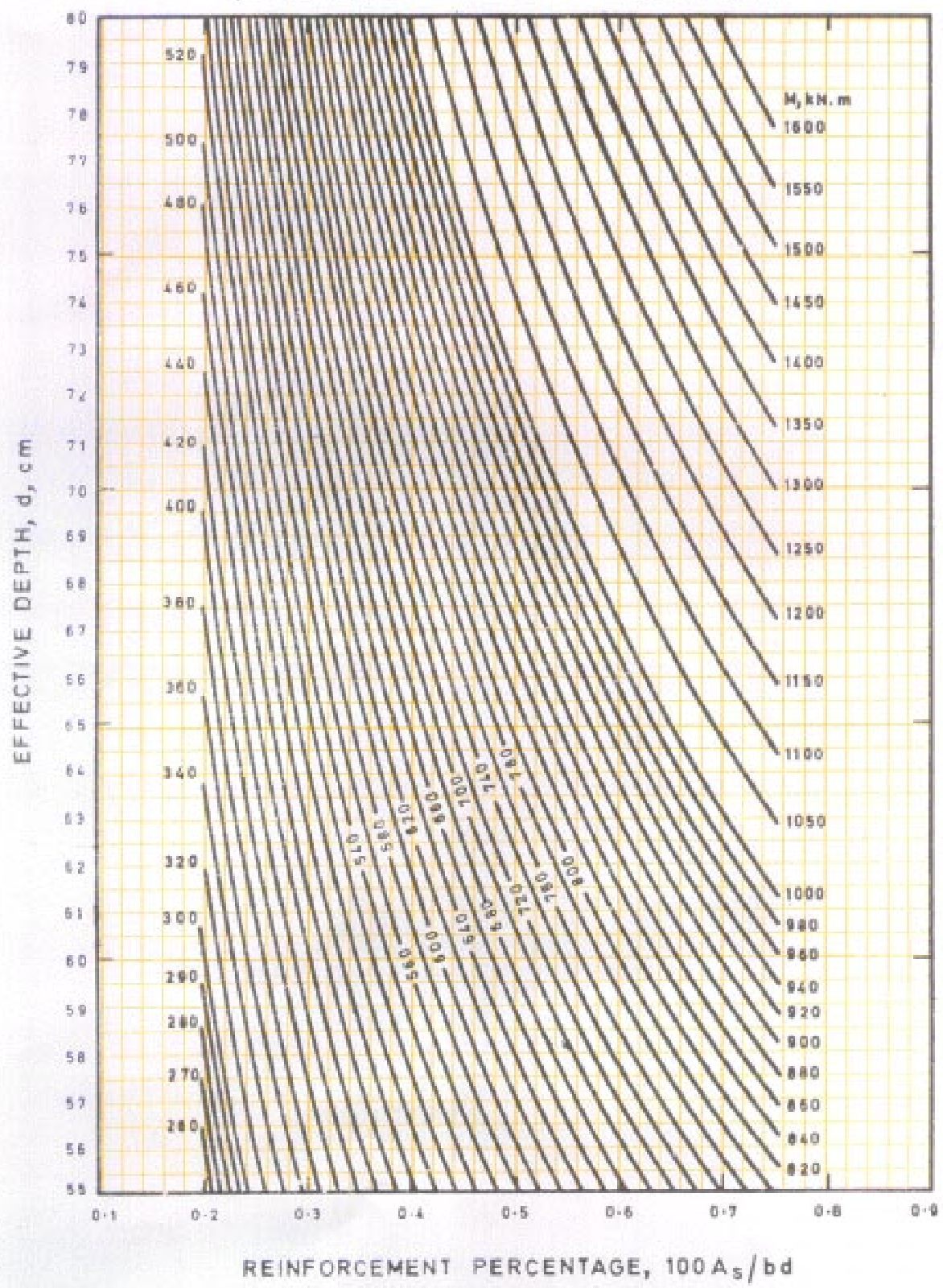


$f_y$   
500  
 $f_{ck}$   
20  
 $d$   
55-8

**Chart 18 FLEXURE — Singly Reinforced Section**  
Moment of Resistance kN.m per Metre Width

$f_y = 500 \text{ N/mm}^2$

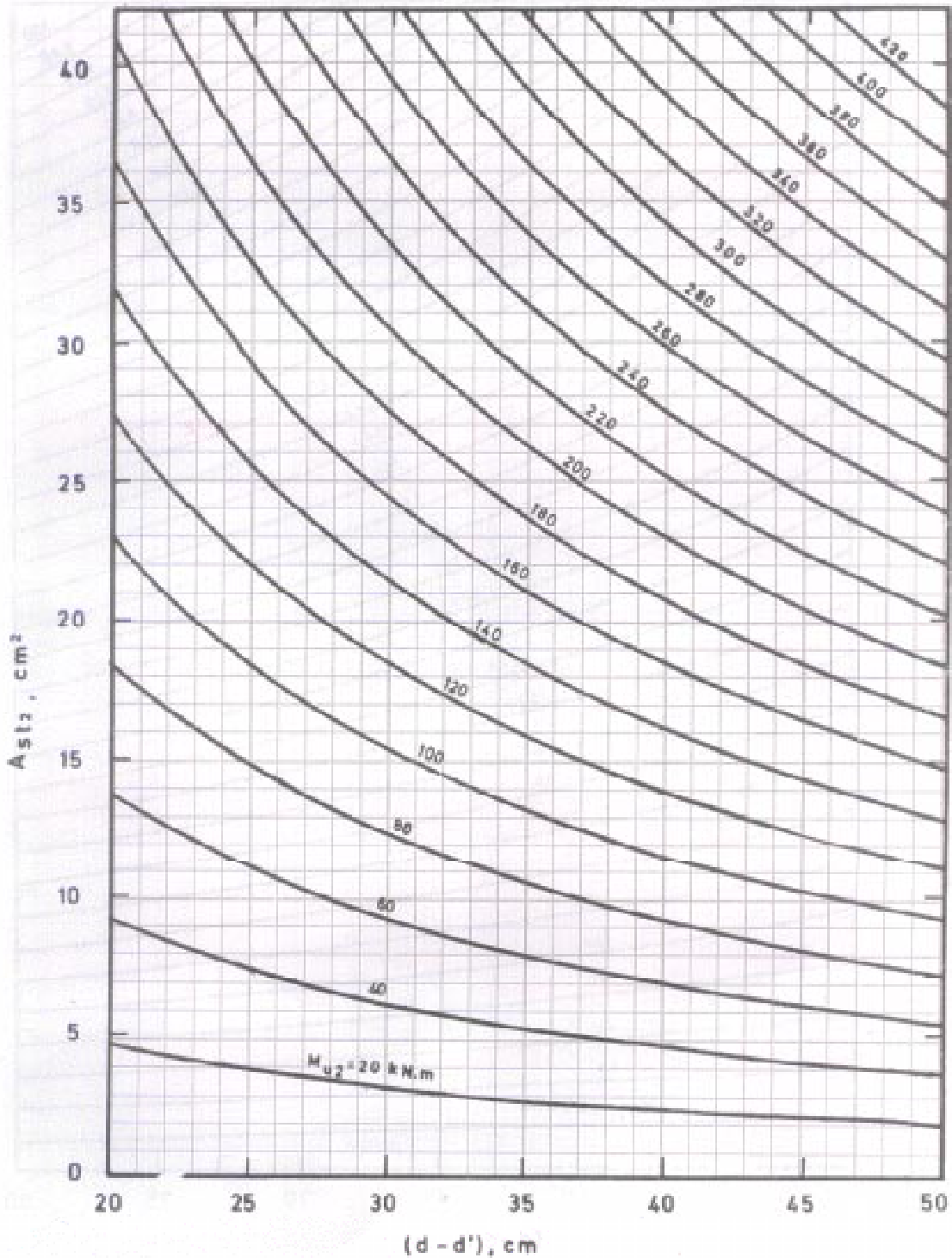
$f_{ck} = 20 \text{ N/mm}^2$



As in the Original Standard, this Page is Intentionally Left Blank

### Chart 19 FLEXURE — Doubly Reinforced Section

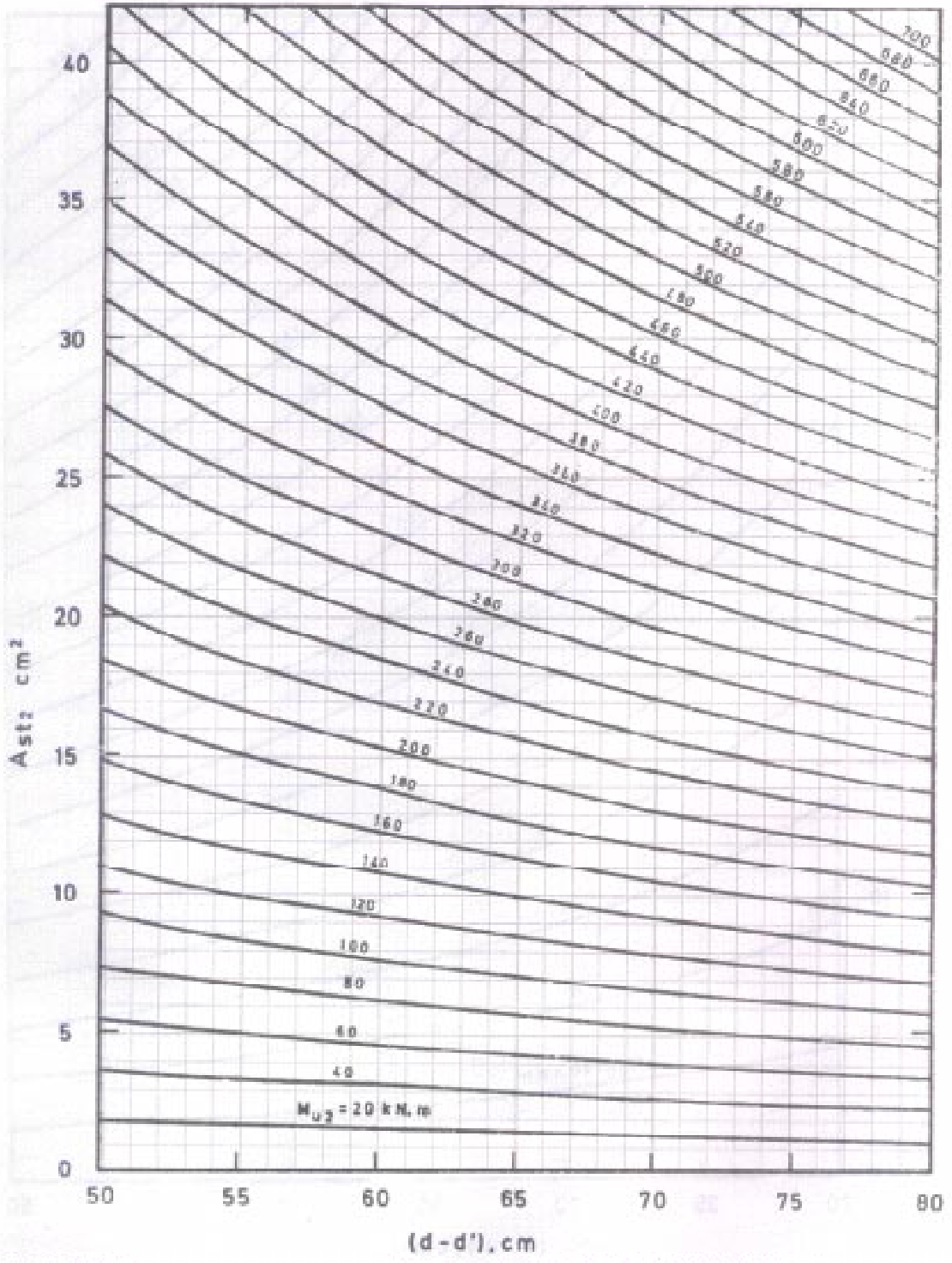
$f_y = 250 \text{ N/mm}^2$





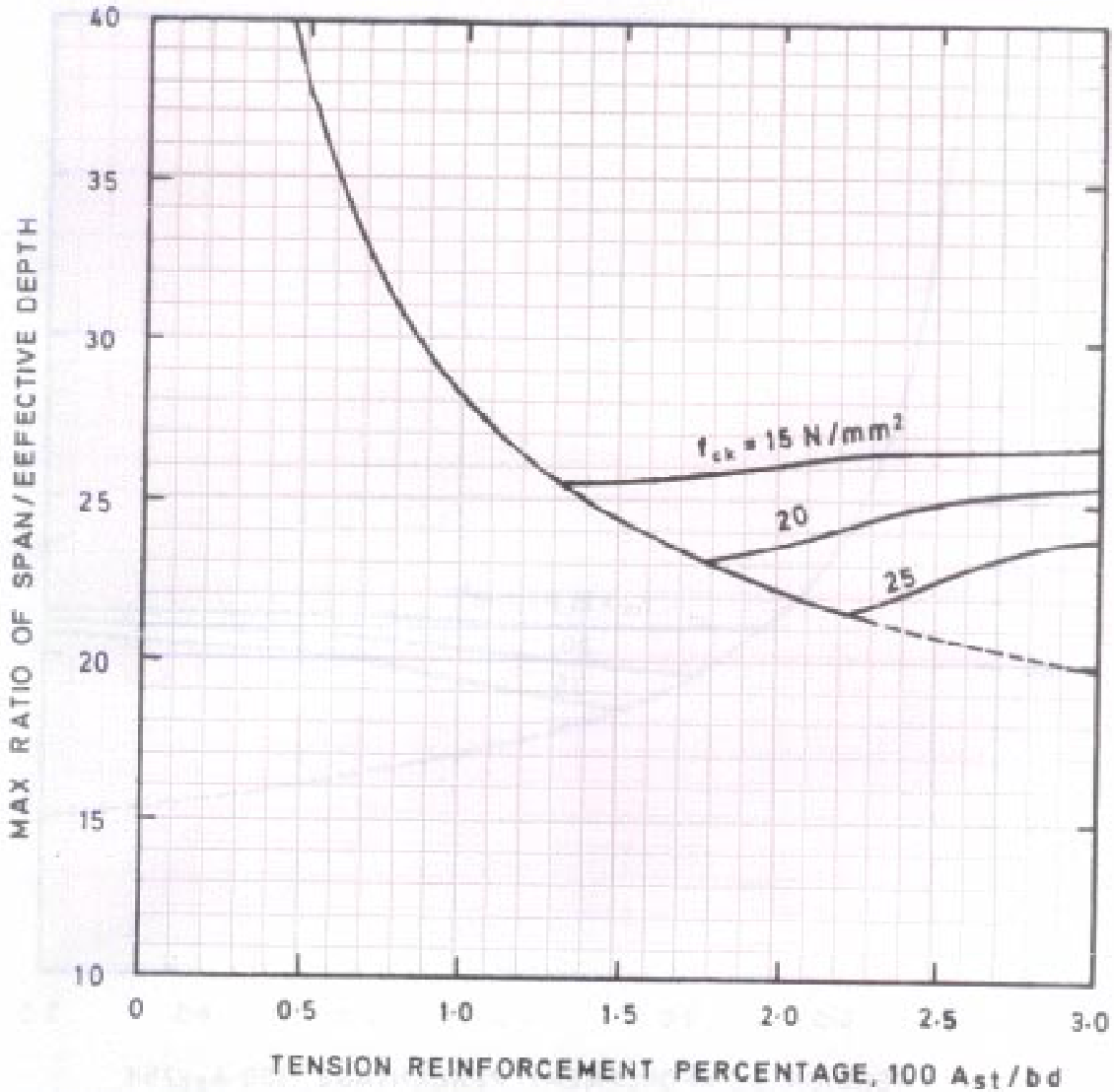
### Chart 20 FLEXURE — Doubly Reinforced Section

$f_y = 250 \text{ N/mm}^2$



**Chart 21 CONTROL OF DEFLECTION**

$f_y = 250 \text{ N/mm}^2$



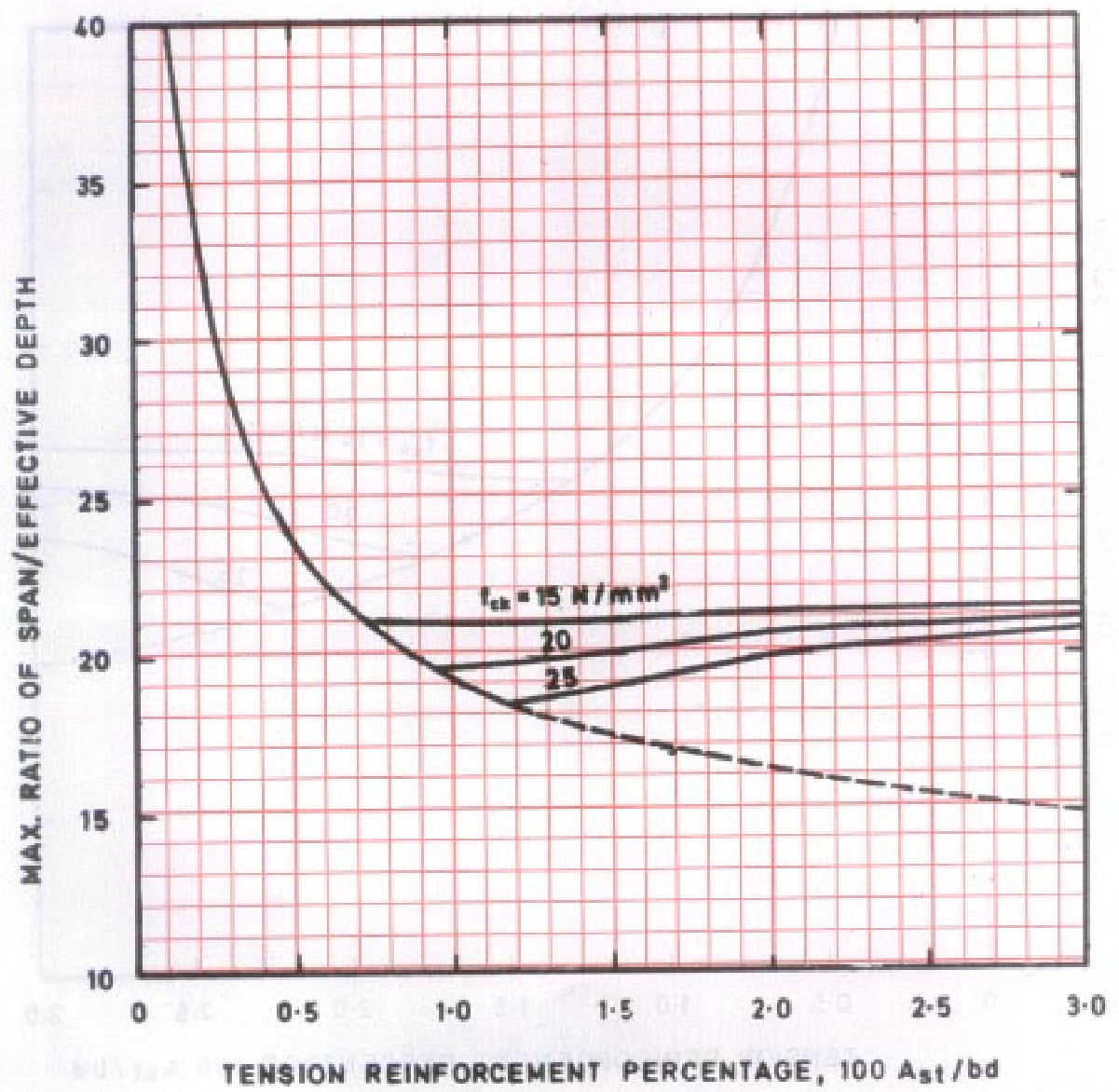
Values for span/effective depth ratio given in this chart are for simply supported spans up to 10 m. For spans over 10 m, multiply the values by 10/span in metres.  
 For continuous beam or slab, multiply the value for simply supported condition by 1.3.  
 For cantilevers up to 10 m, multiply the value from the chart by 0.35.  
 For cantilevers over 10 m, this chart is not valid.

$f_y$   
415

$f_{ck}$   
15  
20  
25

### Chart 22 CONTROL OF DEFLECTION

$f_y = 415 \text{ N/mm}^2$

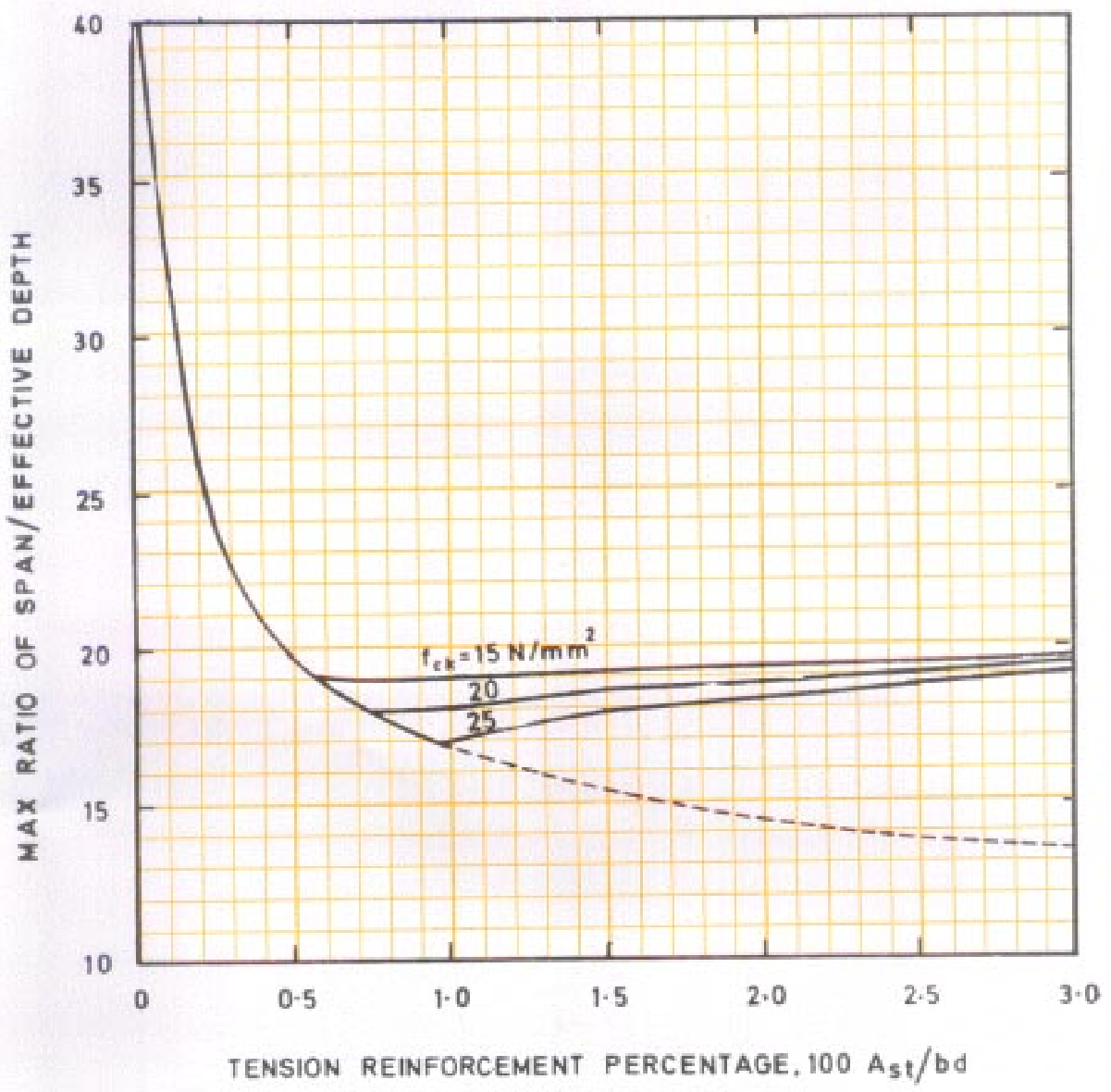


Values of Span/effective depth ratio given in this chart are for simply supported spans up to 10 m. For spans over 10 m, multiply the values by 10/span in metres.  
For continuous beam or slab, multiply the value for simply supported condition by 1.3.  
For cantilevers up to 10 m, multiply the value from the chart by 0.35.  
For cantilevers over 10 m, this chart is not valid.

$f_y$   
500  
 $f_{ck}$   
15  
20  
25

### Chart 23 CONTROL OF DEFLECTION

$f_y = 500 \text{ N/mm}^2$



Values of span/effective depth ratio given in this chart are for simply supported spans up to 10 m. For spans over 10 m, multiply the values by 10/span in metres.  
 For continuous beam or slab, multiply the value for simply supported condition by 1.3.  
 For cantilevers up to 10 m, multiply the value from the chart by 0.35.  
 For cantilevers over 10 m, this chart is not valid.

As in the Original Standard, this Page is Intentionally Left Blank

$f_y$   
240  
250  
415  
480  
500

$f_{ck}$   
25

TABLE 1 FLEXURE — REINFORCEMENT PERCENTAGE,  $p_t$  FOR SINGLY REINFORCED SECTIONS

$f_{ck} = 15 \text{ Nmm}^2$

$M_u/bd^2$ , N/mm <sup>2</sup>	$f_y$ , N/mm <sup>2</sup>					$M_u/bd^2$ , N/mm <sup>2</sup>	$f_y$ , N/mm <sup>2</sup>				
	240	250	415	480	500		240	250	415	480	500
0.30	0.147	0.141	0.085	0.074	0.071	1.50	0.829	0.796	0.480	0.415	0.398
0.35	0.172	0.166	0.100	0.086	0.083	1.52	0.842	0.809	0.487	0.421	0.404
0.40	0.198	0.190	0.114	0.099	0.095	1.54	0.856	0.821	0.495	0.428	0.411
0.45	0.224	0.215	0.129	0.112	0.107	1.56	0.869	0.834	0.503	0.434	0.417
0.50	0.250	0.240	0.144	0.125	0.120	1.58	0.882	0.847	0.510	0.441	0.423
0.55	0.276	0.265	0.159	0.138	0.132	1.60	0.896	0.860	0.518	0.448	0.430
0.60	0.302	0.290	0.175	0.151	0.145	1.62	0.909	0.873	0.526	0.455	0.436
0.65	0.329	0.316	0.190	0.164	0.158	1.64	0.923	0.886	0.534	0.461	0.443
0.70	0.356	0.342	0.206	0.178	0.171	1.66	0.936	0.899	0.542	0.468	0.449
0.75	0.383	0.368	0.221	0.191	0.184	1.68	0.950	0.912	0.550	0.475	0.456
0.80	0.410	0.394	0.237	0.205	0.197	1.70	0.964	0.925	0.558	0.482	0.463
0.82	0.421	0.405	0.244	0.211	0.202	1.72	0.978	0.939	0.566	0.489	0.469
0.84	0.433	0.415	0.250	0.216	0.208	1.74	0.992	0.952	0.574	0.496	0.476
0.86	0.444	0.426	0.257	0.222	0.213	1.76	1.006	0.966	0.582	0.503	0.483
0.88	0.455	0.437	0.263	0.227	0.218	1.78	1.020	0.980	0.590	0.510	0.490
0.90	0.466	0.448	0.270	0.233	0.224	1.80	1.035	0.993	0.598	0.517	0.497
0.92	0.477	0.458	0.276	0.239	0.229	1.82	1.049	1.007	0.607	0.525	0.504
0.94	0.489	0.469	0.283	0.244	0.235	1.84	1.064	1.021	0.615	0.532	0.511
0.96	0.500	0.480	0.289	0.250	0.240	1.86	1.078	1.035	0.624	0.539	0.518
0.98	0.512	0.491	0.296	0.256	0.246	1.88	1.093	1.049	0.632	0.546	0.525
1.00	0.523	0.502	0.303	0.262	0.251	1.90	1.108	1.063	0.641	0.554	0.532
1.02	0.535	0.513	0.309	0.267	0.257	1.92	1.123	1.078	0.649	0.561	0.539
1.04	0.546	0.524	0.316	0.273	0.262	1.94	1.138	1.092	0.658	0.569	0.546
1.06	0.558	0.536	0.323	0.279	0.268	1.96	1.153	1.107	0.667	0.576	0.553
1.08	0.570	0.547	0.329	0.285	0.273	1.98	1.168	1.121	0.676	0.584	0.561
1.10	0.581	0.558	0.336	0.291	0.279	2.00	1.184	1.136	0.685	0.592	
1.12	0.593	0.570	0.343	0.297	0.285	2.02	1.199	1.151	0.693		
1.14	0.605	0.581	0.350	0.303	0.290	2.04	1.215	1.166	0.703		
1.16	0.617	0.592	0.357	0.309	0.296	2.06	1.231	1.181	0.712		
1.18	0.629	0.604	0.364	0.315	0.302	2.08	1.247	1.197			
1.20	0.641	0.615	0.371	0.321	0.308	2.10	1.263	1.212			
1.22	0.653	0.627	0.378	0.327	0.314	2.12	1.279	1.228			
1.24	0.665	0.639	0.385	0.333	0.319	2.14	1.295	1.243			
1.26	0.678	0.650	0.392	0.339	0.325	2.16	1.312	1.259			
1.28	0.690	0.662	0.399	0.345	0.331	2.18	1.328	1.275			
1.30	0.702	0.674	0.406	0.351	0.337	2.20	1.345	1.291			
1.32	0.715	0.686	0.413	0.357	0.343	2.22	1.362	1.308			
1.34	0.727	0.698	0.420	0.364	0.349	2.24	1.379				
1.36	0.740	0.710	0.428	0.370	0.355						
1.38	0.752	0.722	0.435	0.376	0.361						
1.40	0.765	0.734	0.442	0.382	0.367						
1.42	0.778	0.747	0.450	0.389	0.373						
1.44	0.790	0.759	0.457	0.395	0.379						
1.46	0.803	0.771	0.465	0.402	0.386						
1.48	0.816	0.784	0.472	0.408	0.392						

NOTE — Blanks indicate inadmissible reinforcement percentage (see Table E).

$f_y$   
240  
250  
415  
480  
500  
 $f_{ck}$   
20

TABLE 2 FLEXURE — REINFORCEMENT PERCENTAGE,  $p_t$  FOR SINGLY REINFORCED SECTIONS

$f_{ck} = 20 \text{ N/mm}^2$

$M_u/bd^2$ , N/mm <sup>2</sup>	$f_y$ , N/mm <sup>2</sup>					$M_u/bd^2$ , N/mm <sup>2</sup>	$f_y$ , N/mm <sup>2</sup>				
	240	250	415	480	500		240	250	415	480	500
0.30	0.146	0.140	0.085	0.073	0.070	2.22	1.253	1.203	0.725	0.627	0.602
0.35	0.171	0.164	0.099	0.086	0.082	2.24	1.267	1.216	0.733	0.633	0.608
0.40	0.196	0.188	0.114	0.098	0.094	2.26	1.281	1.230	0.741	0.640	0.615
0.45	0.222	0.213	0.128	0.111	0.106	2.28	1.295	1.243	0.749	0.647	0.621
0.50	0.247	0.237	0.143	0.123	0.119	2.30	1.309	1.256	0.757	0.654	0.628
0.55	0.272	0.262	0.158	0.136	0.131	2.32	1.323	1.270	0.765	0.661	0.635
0.60	0.298	0.286	0.172	0.149	0.143	2.34	1.337	1.283	0.773	0.668	0.642
0.65	0.324	0.311	0.187	0.162	0.156	2.36	1.351	1.297	0.781	0.675	0.648
0.70	0.350	0.336	0.203	0.175	0.168	2.38	1.365	1.311	0.790	0.683	0.655
0.75	0.376	0.361	0.218	0.188	0.181	2.40	1.380	1.324	0.798	0.690	0.662
0.80	0.403	0.387	0.233	0.201	0.193	2.42	1.394	1.338	0.806	0.697	0.669
0.85	0.430	0.412	0.248	0.215	0.206	2.44	1.408	1.352	0.814	0.704	0.676
0.90	0.456	0.438	0.264	0.228	0.219	2.46	1.423	1.366	0.823	0.711	0.683
0.95	0.483	0.464	0.280	0.242	0.232	2.48	1.438	1.380	0.831	0.719	0.690
1.00	0.511	0.490	0.295	0.255	0.245	2.50	1.452	1.394	0.840	0.726	0.697
1.05	0.538	0.517	0.311	0.269	0.258	2.52	1.467	1.408	0.848	0.734	0.704
1.10	0.566	0.543	0.327	0.283	0.272	2.54	1.482	1.423	0.857	0.741	0.711
1.15	0.594	0.570	0.343	0.297	0.285	2.56	1.497	1.437	0.866	0.748	0.719
1.20	0.622	0.597	0.359	0.311	0.298	2.58	1.512	1.451	0.874	0.756	0.726
1.25	0.650	0.624	0.376	0.325	0.312	2.60	1.527	1.466	0.883	0.764	0.733
1.30	0.678	0.651	0.392	0.339	0.326	2.62	1.542	1.481	0.892	0.771	0.740
1.35	0.707	0.679	0.409	0.354	0.339	2.64	1.558	1.495	0.901	0.779	0.748
1.40	0.736	0.707	0.426	0.368	0.353	2.66	1.573	1.510	0.910	0.786	0.755
1.45	0.765	0.735	0.443	0.383	0.367	2.68	1.588	1.525	0.919	0.794	
1.50	0.795	0.763	0.460	0.397	0.382	2.70	1.604	1.540	0.928		
1.55	0.825	0.792	0.477	0.412	0.396	2.72	1.620	1.555	0.937		
1.60	0.855	0.821	0.494	0.427	0.410	2.74	1.636	1.570	0.946		
1.65	0.885	0.850	0.512	0.443	0.425	2.76	1.651	1.585	0.955		
1.70	0.916	0.879	0.530	0.458	0.440	2.78	1.667	1.601			
1.75	0.947	0.909	0.547	0.473	0.454	2.80	1.683	1.616			
1.80	0.978	0.939	0.565	0.489	0.469	2.82	1.700	1.632			
1.85	1.009	0.969	0.584	0.505	0.484	2.84	1.716	1.647			
1.90	1.041	1.000	0.602	0.521	0.500	2.86	1.732	1.663			
1.95	1.073	1.030	0.621	0.537	0.515	2.88	1.749	1.679			
2.00	1.106	1.062	0.640	0.553	0.531	2.90	1.766	1.695			
2.02	1.119	1.074	0.647	0.559	0.537	2.92	1.782	1.711			
2.04	1.132	1.087	0.655	0.566	0.543	2.94	1.799	1.727			
2.06	1.145	1.099	0.662	0.573	0.550	2.96	1.816	1.743			
2.08	1.159	1.112	0.670	0.579	0.556	2.98	1.833	1.760			
2.10	1.172	1.125	0.678	0.586	0.562						
2.12	1.185	1.138	0.685	0.593	0.569						
2.14	1.199	1.151	0.693	0.599	0.575						
2.16	1.212	1.164	0.701	0.606	0.582						
2.18	1.226	1.177	0.709	0.613	0.588						
2.20	1.239	1.190	0.717	0.620	0.595						

NOTE — Blanks indicate inadmissible reinforcement percentage (see Table E).

$f_y$   
240  
250  
415  
480  
500

$f_{ck}$   
25

TABLE 3 FLEXURE — REINFORCEMENT PERCENTAGE,  $p_t$  FOR SINGLY REINFORCED SECTIONS

$f_{ck} = 25 \text{ N/mm}^2$

$M_u/bd^2$ , N/mm <sup>2</sup>	$f_y$ , N/mm <sup>2</sup>					$M_u/bd^2$ , N/mm <sup>2</sup>	$f_y$ , N/mm <sup>2</sup>				
	240	250	415	480	500		240	250	415	480	500
0.30	0.146	0.140	0.084	0.073	0.070	2.55	1.415	1.358	0.818	0.708	0.679
0.35	0.171	0.164	0.099	0.085	0.082	2.60	1.448	1.390	0.837	0.724	0.695
0.40	0.195	0.188	0.113	0.098	0.094	2.65	1.482	1.422	0.857	0.741	0.711
0.45	0.220	0.211	0.127	0.110	0.106	2.70	1.515	1.455	0.876	0.758	0.727
0.50	0.245	0.236	0.142	0.123	0.118	2.75	1.549	1.487	0.896	0.775	0.744
0.55	0.271	0.260	0.156	0.135	0.130	2.80	1.584	1.520	0.916	0.792	0.760
0.60	0.296	0.284	0.171	0.148	0.142	2.85	1.618	1.554	0.936	0.809	0.777
0.65	0.321	0.309	0.186	0.161	0.154	2.90	1.653	1.587	0.956	0.827	0.794
0.70	0.347	0.333	0.201	0.174	0.167	2.95	1.689	1.621	0.977	0.844	0.811
0.75	0.373	0.358	0.216	0.186	0.179	3.00	1.724	1.655	0.997	0.862	0.828
0.80	0.399	0.383	0.231	0.199	0.191	3.05	1.760	1.690	1.018	0.880	0.845
0.85	0.425	0.408	0.246	0.212	0.204	3.10	1.797	1.725	1.039	0.898	0.863
0.90	0.451	0.433	0.261	0.225	0.216	3.15	1.834	1.760	1.061	0.917	0.880
0.95	0.477	0.458	0.276	0.239	0.229	3.20	1.871	1.796	1.082	0.936	0.898
1.00	0.504	0.483	0.291	0.252	0.242	3.25	1.909	1.832	1.104	0.954	0.916
1.05	0.530	0.509	0.307	0.265	0.255	3.30	1.947	1.869	1.126	0.973	0.935
1.10	0.557	0.535	0.322	0.279	0.267	3.32	1.962	1.884	1.135	0.981	0.942
1.15	0.584	0.561	0.338	0.292	0.280	3.34	1.978	1.899	1.144	0.989	
1.20	0.611	0.587	0.353	0.306	0.293	3.36	1.993	1.914	1.153		
1.25	0.638	0.613	0.369	0.319	0.306	3.38	2.009	1.929	1.162		
1.30	0.666	0.639	0.385	0.333	0.320	3.40	2.025	1.944	1.171		
1.35	0.693	0.666	0.401	0.347	0.333	3.42	2.040	1.959	1.180		
1.40	0.721	0.692	0.417	0.360	0.346	3.44	2.056	1.974	1.189		
1.45	0.749	0.719	0.433	0.374	0.359	3.46	2.072	1.989			
1.50	0.777	0.746	0.449	0.388	0.373	3.48	2.088	2.005			
1.55	0.805	0.773	0.466	0.403	0.387	3.50	2.104	2.020			
1.60	0.834	0.800	0.482	0.417	0.400	3.52	2.120	2.036			
1.65	0.862	0.828	0.499	0.431	0.414	3.54	2.137	2.051			
1.70	0.891	0.856	0.515	0.446	0.428	3.56	2.153	2.067			
1.75	0.920	0.883	0.532	0.460	0.442	3.58	2.170	2.083			
1.80	0.949	0.911	0.549	0.475	0.456	3.60	2.186	2.099			
1.85	0.979	0.940	0.566	0.489	0.470	3.62	2.203	2.115			
1.90	1.009	0.968	0.583	0.504	0.484	3.64	2.219	2.131			
1.95	1.038	0.997	0.601	0.519	0.498	3.66	2.236	2.147			
2.00	1.068	1.026	0.618	0.534	0.513	3.68	2.253	2.163			
2.05	1.099	1.055	0.635	0.549	0.527	3.70	2.270	2.179			
2.10	1.129	1.084	0.653	0.565	0.542	3.72	2.287	2.196			
2.15	1.160	1.114	0.671	0.580	0.557	3.74	2.304				
2.20	1.191	1.143	0.689	0.596	0.572						
2.25	1.222	1.173	0.707	0.611	0.587						
2.30	1.254	1.204	0.725	0.627	0.602						
2.35	1.285	1.234	0.743	0.643	0.617						
2.40	1.317	1.265	0.762	0.659	0.632						
2.45	1.350	1.296	0.781	0.675	0.648						
2.50	1.382	1.327	0.799	0.691	0.663						

NOTE — Blanks indicate inadmissible reinforcement percentage (see Table E).



$f_y$   
240  
250  
415  
480  
500  
 $f_{ck}$   
30

TABLE 4 FLEXURE — REINFORCEMENT PERCENTAGE,  $p_t$  FOR SINGLY REINFORCED SECTIONS

$f_{ck} = 30 \text{ N/mm}^2$

$M_u/bd^2$ , N/mm <sup>2</sup>	$f_y$ , N/mm <sup>2</sup>					$M_u/bd^2$ , N/mm <sup>2</sup>	$f_y$ , N/mm <sup>2</sup>				
	240	250	415	480	500		240	250	415	480	500
0.30	0.145	0.140	0.084	0.073	0.070	2.55	1.374	1.319	0.794	0.687	0.659
0.35	0.170	0.163	0.098	0.085	0.082	2.60	1.404	1.348	0.812	0.702	0.674
0.40	0.195	0.187	0.113	0.097	0.093	2.65	1.435	1.378	0.830	0.718	0.689
0.45	0.219	0.211	0.127	0.110	0.105	2.70	1.467	1.408	0.848	0.733	0.704
0.50	0.244	0.235	0.141	0.122	0.117	2.75	1.498	1.438	0.866	0.749	0.719
0.55	0.269	0.259	0.156	0.135	0.129	2.80	1.530	1.469	0.885	0.765	0.734
0.60	0.294	0.283	0.170	0.147	0.141	2.85	1.562	1.499	0.903	0.781	0.750
0.65	0.320	0.307	0.185	0.160	0.153	2.90	1.594	1.530	0.922	0.797	0.765
0.70	0.345	0.331	0.200	0.172	0.166	2.95	1.626	1.561	0.940	0.813	0.781
0.75	0.370	0.356	0.214	0.185	0.178	3.00	1.659	1.592	0.959	0.829	0.796
0.80	0.396	0.380	0.229	0.198	0.190	3.05	1.691	1.624	0.978	0.846	0.812
0.85	0.422	0.405	0.244	0.211	0.202	3.10	1.725	1.656	0.997	0.862	0.828
0.90	0.447	0.429	0.259	0.224	0.215	3.15	1.758	1.687	1.017	0.879	0.844
0.95	0.473	0.454	0.274	0.237	0.227	3.20	1.791	1.720	1.036	0.896	0.860
1.00	0.499	0.479	0.289	0.250	0.240	3.25	1.825	1.752	1.055	0.913	0.876
1.05	0.525	0.504	0.304	0.263	0.252	3.30	1.859	1.785	1.075	0.930	0.892
1.10	0.552	0.529	0.319	0.276	0.265	3.35	1.893	1.818	1.095	0.947	0.909
1.15	0.578	0.555	0.334	0.289	0.277	3.40	1.928	1.851	1.115	0.964	0.925
1.20	0.604	0.580	0.350	0.302	0.290	3.45	1.963	1.884	1.135	0.981	0.942
1.25	0.631	0.606	0.365	0.315	0.303	3.50	1.998	1.918	1.156	0.999	0.959
1.30	0.658	0.631	0.380	0.329	0.316	3.55	2.034	1.952	1.176	1.017	0.976
1.35	0.685	0.657	0.396	0.342	0.329	3.60	2.069	1.986	1.197	1.035	0.993
1.40	0.712	0.683	0.411	0.356	0.342	3.65	2.105	2.021	1.218	1.053	1.011
1.45	0.739	0.709	0.427	0.369	0.355	3.70	2.142	2.056	1.239	1.071	1.028
1.50	0.766	0.735	0.443	0.383	0.368	3.75	2.178	2.091	1.260	1.089	1.046
1.55	0.793	0.762	0.459	0.397	0.381	3.80	2.215	2.127	1.281	1.108	1.063
1.60	0.821	0.788	0.475	0.410	0.394	3.85	2.253	2.163	1.303	1.126	1.081
1.65	0.849	0.815	0.491	0.424	0.407	3.90	2.291	2.199	1.325	1.145	1.099
1.70	0.876	0.841	0.507	0.438	0.421	3.95	2.329	2.236	1.347	1.164	1.118
1.75	0.904	0.868	0.523	0.452	0.434	4.00	2.367	2.273	1.369	1.184	
1.80	0.932	0.895	0.539	0.466	0.448	4.05	2.406	2.310	1.391		
1.85	0.961	0.922	0.556	0.480	0.461	4.10	2.445	2.348	1.414		
1.90	0.989	0.950	0.572	0.495	0.475	4.15	2.485	2.386			
1.95	1.018	0.977	0.589	0.509	0.488	4.20	2.525	2.424			
2.00	1.046	1.005	0.605	0.523	0.502	4.25	2.566	2.463			
2.05	1.075	1.032	0.622	0.538	0.516	4.30	2.607	2.502			
2.10	1.104	1.060	0.639	0.552	0.530	4.35	2.648	2.542			
2.15	1.134	1.088	0.656	0.567	0.544	4.40	2.690	2.583			
2.20	1.163	1.116	0.673	0.581	0.558	4.45	2.733	2.623			
2.25	1.192	1.145	0.690	0.596	0.572						
2.30	1.222	1.173	0.707	0.611	0.587						
2.35	1.252	1.202	0.724	0.626	0.601						
2.40	1.282	1.231	0.742	0.641	0.615						
2.45	1.312	1.260	0.759	0.656	0.630						
2.50	1.343	1.289	0.777	0.671	0.645						

NOTE — Blanks indicate inadmissible reinforcement percentage (see Table E).

$f_y$   
250 $f_{ck}$   
15 $t$   
10  
11

TABLE 5 FLEXURE — MOMENT OF RESISTANCE OF SLABS, kN.m PER METRE WIDTH

 $f_{ck} = 15 \text{ N/mm}^2$   
 $f_y = 250 \text{ N/mm}^2$   
Thickness = 10.0 cm

BAR SPACING, cm	BAR DIAMETER, mm				BAR SPACING, cm	BAR DIAMETER, mm			
	6	8	10	12		6	8	10	12
5	8.92	14.02	0.00	0.00	20	0.00	4.20	6.27	8.55
6	7.39	12.20	0.00	0.00	21	0.00	4.01	6.00	8.19
7	6.61	10.77	0.00	0.00	22	0.00	3.83	5.74	7.87
8	5.85	9.63	13.56	0.00	23	0.00	3.67	5.51	7.56
9	5.24	8.70	12.40	0.00	24	0.00	3.53	5.30	7.28
10	4.75	7.93	11.41	0.00	25	0.00	3.39	5.10	7.02
11	4.34	7.29	10.56	13.81	26	0.00	3.27	4.92	6.78
12	4.00	6.74	9.82	12.95	27	0.00	3.15	4.75	6.56
13	3.70	6.26	9.18	12.19	28	0.00	3.04	4.59	6.34
14	3.45	5.85	8.61	11.50	29	0.00	2.94	4.44	6.14
15	3.23	5.49	8.11	10.88	30	0.00	2.85	4.30	5.96
16	3.04	5.17	7.66	10.32	35	0.00	0.00	3.72	5.17
17	2.86	4.89	7.26	9.81	40	0.00	0.00	3.27	4.56
18	2.71	4.63	6.90	9.35					
19	0.00	4.40	6.57	8.93					

NOTE 1 — Zeros indicate inadmissible reinforcement percentage.

NOTE 2 — Bar spacings below the dividing line exceed 3d.

TABLE 6 FLEXURE — MOMENT OF RESISTANCE OF SLABS, kN.m PER METRE WIDTH

 $f_{ck} = 15 \text{ N/mm}^2$   
 $f_y = 250 \text{ N/mm}^2$   
Thickness = 11.0 cm

BAR SPACING, cm	BAR DIAMETER, mm				BAR SPACING, cm	BAR DIAMETER, mm			
	6	8	10	12		6	8	10	12
5	10.15	16.21	0.00	0.00	20	0.00	4.74	7.12	9.78
6	8.62	14.02	0.00	0.00	21	0.00	4.53	6.81	9.36
7	7.48	12.33	17.37	0.00	22	0.00	4.33	6.52	8.98
8	6.61	10.99	15.70	0.00	23	0.00	4.15	6.26	8.63
9	5.92	9.91	14.30	0.00	24	0.00	3.98	6.01	8.31
10	5.36	9.02	13.12	17.23	25	0.00	3.83	5.79	8.01
11	4.90	8.28	12.11	16.04	26	0.00	3.69	5.58	7.73
12	4.51	7.65	11.25	15.00	27	0.00	3.56	5.38	7.47
13	4.18	7.10	10.49	14.08	28	0.00	3.43	5.20	7.22
14	3.89	6.63	9.83	13.25	29	0.00	3.32	5.03	6.99
15	3.64	6.22	9.25	12.52	30	0.00	3.21	4.87	6.78
16	3.42	5.86	8.73	11.86	35	0.00	0.00	4.21	5.87
17	3.23	5.53	8.26	11.26	40	0.00	0.00	3.70	5.18
18	0.00	5.24	7.84	10.72	45	0.00	0.00	3.30	4.63
19	0.00	4.98	7.47	10.23					

NOTE 1 — Zeros indicate inadmissible reinforcement percentage.

NOTE 2 — Bar spacings below the dividing line exceed 3d.

$f_y$   
250  
 $f_{ck}$   
15  
 $t$   
12  
13

TABLE 7 FLEXURE—MOMENT OF RESISTANCE OF SLABS, kN.m PER METRE WIDTH

$f_{ck} = 15 \text{ N/mm}^2$   
 $f_y = 250 \text{ N/mm}^2$   
Thickness = 12.0 cm

BAR SPACING, cm	BAR DIAMETER, mm				BAR SPACING, cm	BAR DIAMETER, mm			
	6	8	10	12		6	8	10	12
5	11.37	18.39	0.00	0.00	20	0.00	5.29	7.98	11.01
6	9.64	15.84	22.22	0.00	21	0.00	5.05	7.62	10.53
7	8.36	13.89	19.81	0.00	22	0.00	4.83	7.30	10.10
8	7.38	12.36	17.83	0.00	23	0.00	4.62	7.00	9.70
9	6.61	11.13	16.20	21.30	24	0.00	4.44	6.72	9.33
10	5.98	10.12	14.83	19.68	25	0.00	4.27	6.47	8.99
11	5.46	9.27	13.67	18.28	26	0.00	4.11	6.23	8.67
12	5.02	8.56	12.67	17.05	27	0.00	3.96	6.02	8.38
13	4.65	7.95	11.80	15.97	28	0.00	0.00	5.81	8.10
14	4.33	7.41	11.05	15.01	29	0.00	0.00	5.62	7.84
15	4.05	6.95	10.38	14.16	30	0.00	0.00	5.44	7.60
16	0.00	6.54	9.79	13.39	35	0.00	0.00	4.69	6.57
17	0.00	6.17	9.27	12.71	40	0.00	0.00	4.13	5.79
18	0.00	5.85	8.79	12.09	45	0.00	0.00	0.00	5.18
19	0.00	5.55	8.36	11.52					

NOTE 1—Zeros indicate inadmissible reinforcement percentage.

NOTE 2—Bar spacings below the dividing line exceed 3d.

TABLE 8 FLEXURE—MOMENT OF RESISTANCE OF SLABS, kN.m PER METRE WIDTH

$f_{ck} = 15 \text{ N/mm}^2$   
 $f_y = 250 \text{ N/mm}^2$   
Thickness = 13.0 cm

BAR SPACING, cm	BAR DIAMETER, mm					BAR SPACING, cm	BAR DIAMETER, mm				
	6	8	10	12	16		6	8	10	12	16
5	12.60	22.58	0.00	0.00	0.00	20	0.00	5.83	8.83	12.24	19.49
6	10.67	17.66	25.06	0.00	0.00	21	0.00	5.57	8.43	11.71	18.73
7	9.24	15.45	22.25	0.00	0.00	22	0.00	5.32	8.07	11.22	18.02
8	8.15	13.72	19.97	26.22	0.00	23	0.00	5.10	7.74	10.77	17.36
9	7.29	12.34	18.16	24.03	0.00	24	0.00	4.89	7.44	10.36	16.75
10	6.59	11.21	16.54	22.14	0.00	25	0.00	4.70	7.15	9.97	16.18
11	6.02	10.27	15.22	20.51	0.00	26	0.00	0.00	6.89	9.62	15.64
12	5.53	9.47	14.09	19.10	0.00	27	0.00	0.00	6.65	9.29	15.14
13	5.12	8.79	13.12	17.86	0.00	28	0.00	0.00	6.42	8.98	14.67
14	4.77	8.19	12.27	16.77	0.00	29	0.00	0.00	6.21	8.69	14.23
15	0.00	7.68	11.52	15.80	24.35	30	0.00	0.00	6.01	8.42	13.81
16	0.00	7.22	10.86	14.93	23.21	35	0.00	0.00	5.18	7.28	12.09
17	0.00	6.82	10.27	14.15	22.16	40	0.00	0.00	4.55	6.41	10.66
18	0.00	6.45	9.74	13.45	21.20	45	0.00	0.00	0.00	3.73	9.57
19	0.00	6.13	9.26	12.81	20.31						

NOTE 1—Zeros indicate inadmissible reinforcement percentage.

NOTE 2—Bar spacings below the dividing line exceed 3d.

$f_y$   
250 $f_{ck}$   
15 $t$   
14  
15

TABLE 9 FLEXURE — MOMENT OF RESISTANCE OF SLABS, kN.m PER METRE WIDTH

$f_{ck} = 15 \text{ N/mm}^2$   
 $f_y = 250 \text{ N/mm}^2$   
Thickness = 140 cm

BAR SPACING, cm	BAR DIAMETER, mm					BAR SPACING, cm	BAR DIAMETER, mm				
	6	8	10	12	16		6	8	10	12	16
5	13.83	22.76	31.99	0.00	0.00	20	0.00	6.38	9.68	13.46	21.67
6	11.69	19.48	27.91	0.00	0.00	21	0.00	6.09	9.25	13.88	20.81
7	10.12	17.01	24.69	0.00	0.00	22	0.00	5.82	8.85	12.34	20.01
8	8.92	15.09	22.10	29.30	0.00	23	0.00	5.57	8.48	11.84	19.26
9	7.97	13.56	19.99	26.76	0.00	24	0.00	0.00	8.15	11.38	18.57
10	7.21	12.30	18.24	24.60	0.00	25	0.00	0.00	7.84	10.96	17.93
11	6.58	11.26	16.77	22.75	0.00	26	0.00	0.00	7.55	10.56	17.32
12	6.05	10.38	15.51	21.15	0.00	27	0.00	0.00	7.28	10.20	16.76
13	5.60	9.63	14.43	19.75	0.00	28	0.00	0.00	7.03	9.86	16.23
14	0.00	8.97	13.49	18.52	28.71	29	0.00	0.00	6.80	9.54	15.73
15	0.00	8.41	12.66	17.44	27.26	30	0.00	0.00	6.58	9.24	15.27
16	0.00	7.90	11.93	16.47	25.94	33	0.00	0.00	5.67	7.98	13.29
17	0.00	7.46	11.28	15.60	24.73	40	0.00	0.00	0.00	7.02	11.76
18	0.00	7.06	10.69	14.82	23.63	45	0.00	0.00	0.00	6.27	10.54
19	0.00	6.70	10.16	14.11	22.61						

NOTE 1 — Zeros indicate inadmissible reinforcement percentage.

NOTE 2 — Bar spacings below the dividing line exceed  $3d$ .

TABLE 10 FLEXURE — MOMENT OF RESISTANCE OF SLABS, kN.m PER METRE WIDTH

$f_{ck} = 15 \text{ N/mm}^2$   
 $f_y = 250 \text{ N/mm}^2$   
Thickness = 150 cm

BAR SPACING, cm	BAR DIAMETER, mm					
	6	8	10	12	16	18
5	15.06	24.93	35.41	0.00	0.00	0.00
6	12.71	21.30	30.76	0.00	0.00	0.00
7	11.00	18.57	27.13	35.81	0.00	0.00
8	9.69	16.46	24.24	32.37	0.00	0.00
9	8.66	14.77	21.89	29.49	0.00	0.00
10	7.82	13.39	19.95	27.06	0.00	0.00
11	7.14	12.25	18.32	24.98	0.00	0.00
12	6.56	11.29	16.94	23.20	0.00	0.00
13	0.00	10.47	15.75	21.64	33.66	0.00
14	0.00	9.76	14.71	20.28	31.83	0.00
15	0.00	9.13	13.80	19.07	30.17	0.00
16	0.00	8.59	13.00	18.00	28.67	33.32
17	0.00	8.10	12.28	17.25	27.30	31.87
18	0.00	7.67	11.64	16.18	26.05	30.53
19	0.00	7.28	11.06	15.40	24.91	29.28
20	0.00	6.93	10.54	14.69	23.86	28.13
21	0.00	6.61	10.06	14.05	22.89	27.06
22	0.00	6.32	9.63	13.45	21.99	26.06
23	0.00	0.00	9.23	12.91	21.16	25.13
24	0.00	0.00	8.86	12.41	20.39	24.26
25	0.00	0.00	8.52	11.94	19.67	23.45
26	0.00	0.00	8.20	11.51	19.00	22.68
27	0.00	0.00	7.91	11.11	18.38	21.97
28	0.00	0.00	7.64	10.73	17.79	21.29
29	0.00	0.00	7.39	10.38	17.24	20.66
30	0.00	0.00	7.15	10.05	16.72	20.06
35	0.00	0.00	0.00	8.68	14.53	17.52
40	0.00	0.00	0.00	7.64	12.85	15.54
45	0.00	0.00	0.00	6.82	11.51	13.96

NOTE 1 — Zeros indicate inadmissible reinforcement percentage.

NOTE 2 — Bar spacings below the dividing line exceed  $3d$ .

$f_y$   
250  
 $f_{ck}$   
15  
 $f$   
17.5

TABLE 11 FLEXURE — MOMENT OF RESISTANCE OF SLABS, kN.m PER METRE WIDTH

BAR SPACING, cm	BAR DIAMETER, mm						
	6	8	10	12	16	18	20
5	18.14	30.41	43.95	0.00	0.00	0.00	0.00
6	15.28	25.86	37.87	50.17	0.00	0.00	0.00
7	13.19	22.48	33.22	44.59	0.00	0.00	0.00
8	11.61	19.87	29.57	40.05	0.00	0.00	0.00
9	10.36	17.81	26.63	36.32	0.00	0.00	0.00
10	9.36	16.13	24.22	33.21	0.00	0.00	0.00
11	0.00	14.74	22.20	30.57	47.84	0.00	0.00
12	0.00	13.57	20.49	28.32	44.78	0.00	0.00
13	0.00	12.57	19.03	26.37	42.06	0.00	0.00
14	0.00	11.71	17.76	24.67	39.63	46.45	0.00
15	0.00	10.96	16.64	23.17	37.46	44.10	0.00
16	0.00	10.29	15.66	21.85	35.50	41.96	0.00
17	0.00	9.71	14.79	20.66	33.73	40.00	45.82
18	0.00	9.19	14.01	19.60	32.12	38.21	43.93
19	0.00	8.72	13.31	18.64	30.66	36.56	42.17
20	0.00	0.00	12.67	17.77	29.32	35.04	40.53
21	0.00	0.00	12.09	16.97	28.09	33.64	39.01
22	0.00	0.00	11.57	16.25	26.96	32.34	37.59
23	0.00	0.00	11.08	15.58	25.91	31.14	36.26
24	0.00	0.00	10.64	14.97	24.95	30.02	35.02
25	0.00	0.00	10.23	14.40	24.05	28.98	33.86
26	0.00	0.00	9.85	13.87	23.21	28.00	32.77
27	0.00	0.00	9.49	13.38	22.43	27.09	31.75
28	0.00	0.00	9.17	12.93	21.69	26.23	30.78
29	0.00	0.00	8.86	12.50	21.01	25.43	29.88
30	0.00	0.00	0.00	12.10	20.36	24.67	29.02
35	0.00	0.00	0.00	10.44	17.66	21.47	25.36
40	0.00	0.00	0.00	9.17	15.58	18.99	22.51
45	0.00	0.00	0.00	0.00	13.94	17.03	20.23

$f_k = 15 \text{ N/mm}^2$   
 $f_y = 250 \text{ N/mm}^2$   
Thickness — 17.5 cm

Note — Zeros indicate inadmissible reinforcement percentage.

$f_y$   
250  
 $f_{ck}$   
15  
 $t$   
20

TABLE 12 FLEXURE — MOMENT OF RESISTANCE OF SLABS, kN.m PER METRE WIDTH

$f_{ck} = 15 \text{ N/mm}^2$   
 $f_y = 250 \text{ N/mm}^2$   
Thickness = 20.0 cm

BAR SPACING, cm	BAR DIAMETER, mm								
	6	8	10	12	16	18	20	22	25
5	21.21	35.88	52.48	69.39	0.00	0.00	0.00	0.00	0.00
6	17.84	30.41	44.98	60.41	0.00	0.00	0.00	0.00	0.00
7	15.39	26.38	39.32	53.37	0.00	0.00	0.00	0.00	0.00
8	13.53	23.29	34.91	47.74	0.00	0.00	0.00	0.00	0.00
9	12.07	20.84	31.38	43.15	67.31	0.00	0.00	0.00	0.00
10	0.00	18.96	28.49	39.35	62.21	0.00	0.00	0.00	0.00
11	0.00	17.22	26.08	36.16	57.77	0.00	0.00	0.00	0.00
12	0.00	15.84	24.05	33.44	53.89	63.38	0.00	0.00	0.00
13	0.00	14.67	22.31	31.10	50.47	59.67	0.00	0.00	0.00
14	0.00	13.66	20.81	29.06	47.44	56.33	0.00	0.00	0.00
15	0.00	12.78	19.49	27.27	44.74	53.32	61.43	0.00	0.00
16	0.00	12.00	18.33	25.69	42.33	50.61	58.53	0.00	0.00
17	0.00	0.00	17.30	24.28	40.16	48.14	55.86	0.00	0.00
18	0.00	0.00	16.38	23.01	38.20	45.89	53.41	60.43	0.00
19	0.00	0.00	15.55	21.87	36.41	43.84	51.15	58.06	0.00
20	0.00	0.00	14.81	20.84	34.78	41.96	49.07	55.85	0.00
21	0.00	0.00	14.13	19.90	33.30	40.23	47.14	53.79	0.00
22	0.00	0.00	13.51	19.04	31.93	38.63	45.35	51.86	0.00
23	0.00	0.00	12.94	18.25	30.66	37.15	43.69	50.06	58.81
24	0.00	0.00	12.42	17.53	29.50	35.78	42.14	48.37	57.02
25	0.00	0.00	11.93	15.86	28.42	34.51	40.69	46.78	55.33
26	0.00	0.00	11.49	16.24	27.41	33.32	39.34	45.30	53.72
27	0.00	0.00	0.00	15.66	26.47	32.21	38.07	43.90	52.19
28	0.00	0.00	0.00	15.12	25.60	31.17	36.88	42.58	50.74
29	0.00	0.00	0.00	14.62	24.78	30.20	35.76	41.33	49.36
30	0.00	0.00	0.00	14.15	24.01	29.28	34.71	40.16	48.06
35	0.00	0.00	0.00	12.19	20.78	25.42	30.24	35.14	42.38
40	0.00	0.00	0.00	0.00	18.31	22.45	26.78	31.21	37.87
45	0.00	0.00	0.00	0.00	16.37	20.10	24.03	28.07	34.20

Note — Zeros indicate inadmissible reinforcement percentage.

$f_y$   
250  
 $f_{ck}$   
15  
 $f$   
22.5

TABLE 13. FLEXURE — MOMENT OF RESISTANCE OF SLABS, kN.m PER METRE WIDTH

$f_{ch} = 15 \text{ N/mm}^2$   
 $f_s = 250 \text{ N/mm}^2$   
Thickness = 22.5 cm

BAR SPACING, cm	BAR DIAMETER, mm								
	5	8	10	12	16	18	20	22	25
5	24.28	41.34	61.02	81.69	0.00	0.00	0.00	0.00	0.00
6	20.40	34.96	52.10	70.66	0.00	0.00	0.00	0.00	0.00
7	17.58	30.28	45.42	62.15	0.00	0.00	0.00	0.00	0.00
8	15.45	26.70	40.24	55.42	86.82	0.00	0.00	0.00	0.00
9	0.00	23.88	36.12	49.98	79.45	0.00	0.00	0.00	0.00
10	0.00	21.59	32.76	45.50	72.14	85.96	0.00	0.00	0.00
11	0.00	19.70	29.96	41.73	67.71	80.09	0.00	0.00	0.00
12	0.00	18.12	27.61	38.56	62.99	74.91	0.00	0.00	0.00
13	0.00	16.77	25.60	35.83	58.87	70.31	81.18	0.00	0.00
14	0.00	15.61	23.86	33.43	55.24	66.21	76.79	0.00	0.00
15	0.00	0.00	22.34	31.37	52.03	62.54	72.81	0.00	0.00
16	0.00	0.00	21.00	29.53	49.16	59.25	69.20	78.62	0.00
17	0.00	0.00	19.81	27.89	46.29	56.27	65.91	75.13	0.00
18	0.00	0.00	18.75	26.43	44.27	53.58	62.90	71.91	0.00
19	0.00	0.00	17.80	25.11	42.16	51.12	60.14	68.93	0.00
20	0.00	0.00	16.94	23.91	40.23	48.87	57.61	66.18	78.11
21	0.00	0.00	16.16	22.83	38.50	46.81	55.27	63.63	75.39
22	0.00	0.00	15.43	21.84	36.89	44.92	53.11	61.25	72.82
23	0.00	0.00	14.79	20.93	35.42	43.17	51.11	59.04	70.41
24	0.00	0.00	0.00	20.09	34.05	41.53	49.25	56.98	68.14
25	0.00	0.00	0.00	19.32	32.79	40.04	47.52	55.05	66.00
26	0.00	0.00	0.00	18.60	31.61	38.64	45.91	53.24	63.98
27	0.00	0.00	0.00	17.94	30.52	37.33	44.40	51.55	62.07
28	0.00	0.00	0.00	17.32	29.50	36.11	42.98	49.96	60.27
29	0.00	0.00	0.00	16.74	28.54	34.97	41.65	48.46	58.56
30	0.00	0.00	0.00	16.20	27.65	33.89	40.40	47.04	56.95
35	0.00	0.00	0.00	0.00	23.90	29.37	35.12	41.04	50.01
40	0.00	0.00	0.00	0.00	21.04	25.91	31.03	36.38	44.54
45	0.00	0.00	0.00	0.00	18.80	23.18	27.82	32.66	40.13

NOTE — Zeros indicate inadmissible reinforcement percentage.

$f_y$   
250

$f_{ck}$   
15

$t$   
25

TABLE 14 FLEXURE — MOMENT OF RESISTANCE OF SLABS, kN.m PER METRE WIDTH

$f_{ck} = 15 \text{ N/mm}^2$   
 $f_y = 250 \text{ N/mm}^2$   
Thickness = 25.0 cm

BAR SPACING, cm	BAR DIAMETER, mm									
	6	8	10	12	16	18	20	22	25	
5	27.36	46.80	69.56	93.98	0.00	0.00	0.00	0.00	0.00	
6	22.96	39.31	59.21	80.90	0.00	0.00	0.00	0.00	0.00	
7	19.78	34.18	51.52	70.93	111.08	0.00	0.00	0.00	0.00	
8	0.00	30.12	45.58	63.10	100.48	0.00	0.00	0.00	0.00	
9	0.00	26.91	40.86	56.81	91.59	107.96	0.00	0.00	0.00	
10	0.00	24.32	37.02	51.65	84.07	99.79	0.00	0.00	0.00	
11	0.00	22.19	33.84	47.34	77.64	92.66	106.90	0.00	0.00	
12	0.00	20.40	31.17	43.69	72.10	86.43	100.26	0.00	0.00	
13	0.00	18.87	28.88	40.55	67.28	80.94	94.32	0.00	0.00	
14	0.00	0.00	26.90	37.84	63.05	76.09	83.99	101.25	0.00	
15	0.00	0.00	25.18	35.47	59.31	71.76	84.20	96.17	0.00	
16	0.00	0.00	23.67	33.37	55.99	67.89	79.87	91.53	0.00	
17	0.00	0.00	22.32	31.51	53.01	64.41	75.95	87.28	0.00	
18	0.00	0.00	21.12	29.84	50.34	61.26	72.38	83.39	98.90	
19	0.00	0.00	20.05	28.34	47.91	58.40	69.13	79.81	95.05	
20	0.00	0.00	19.07	26.99	45.71	55.79	66.14	76.51	91.45	
21	0.00	0.00	0.00	25.75	43.70	53.40	63.40	73.46	88.09	
22	0.00	0.00	0.00	24.63	41.86	51.20	60.87	70.64	84.95	
23	0.00	0.00	0.00	23.60	40.17	49.18	58.53	68.02	82.01	
24	0.00	0.00	0.00	22.65	38.60	47.31	56.37	65.58	79.25	
25	0.00	0.00	0.00	21.78	37.16	45.57	54.35	63.31	76.67	
26	0.00	0.00	0.00	20.97	35.82	43.96	52.47	61.19	74.24	
27	0.00	0.00	0.00	20.21	34.57	42.46	50.72	59.20	71.95	
28	0.00	0.00	0.00	19.51	33.40	41.05	49.08	57.33	69.80	
29	0.00	0.00	0.00	18.86	32.31	39.74	47.54	55.58	67.76	
30	0.00	0.00	0.00	18.25	31.29	38.50	46.09	53.93	65.84	
33	0.00	0.00	0.00	0.00	27.02	33.32	40.00	46.94	57.63	
40	0.00	0.00	0.00	0.00	23.78	29.37	35.32	41.54	51.21	
45	0.00	0.00	0.00	0.00	21.22	26.25	31.61	37.25	46.06	

Note — Zeros indicate inadmissible reinforcement percentage.



$f_y$   
415  
 $f_{ck}$   
15  
 $t$   
10  
11

TABLE 15 FLEXURE — MOMENT OF RESISTANCE OF SLABS, kN.m PER METRE WIDTH

$f_{ck} = 15 \text{ N/mm}^2$   
 $f_y = 415 \text{ N/mm}^2$   
Thickness = 10.0 cm

BAR SPACING, cm	BAR DIAMETER, mm				BAR SPACING, cm	BAR DIAMETER, mm			
	6	8	10	12		6	8	10	12
5	13.53	0.00	0.00	0.00	20	3.98	6.71	9.79	12.91
6	11.72	0.00	0.00	0.00	21	3.80	6.42	9.39	12.44
7	10.32	0.00	0.00	0.00	22	3.64	6.15	9.03	12.00
8	9.21	0.00	0.00	0.00	23	3.49	5.91	8.69	11.59
9	8.31	13.20	0.00	0.00	24	0.00	5.68	8.37	11.21
10	7.56	12.16	0.00	0.00	25	0.00	5.47	8.08	10.84
11	6.94	11.26	0.00	0.00	26	0.00	5.28	7.81	10.50
12	6.42	10.48	0.00	0.00	27	0.00	5.09	7.55	10.18
13	5.96	9.80	0.00	0.00	28	0.00	4.92	7.31	9.88
14	5.57	9.20	13.04	0.00	29	0.00	4.77	7.08	9.59
15	5.22	8.67	12.37	0.00	30	0.00	4.62	6.87	9.32
16	4.92	8.19	11.75	0.00	35	0.00	3.99	5.97	8.16
17	4.64	7.77	11.20	0.00	40	0.00	3.51	5.28	7.26
18	4.40	7.38	10.69	0.00					
19	4.18	7.03	10.22	0.00					

NOTE 1 — Zeros indicate inadmissible reinforcement percentage.

NOTE 2 — Bar spacings below the dividing line exceed 3d.

TABLE 16 FLEXURE — MOMENT OF RESISTANCE OF SLABS, kN.m PER METRE WIDTH

$f_{ck} = 15 \text{ N/mm}^2$   
 $f_y = 415 \text{ N/mm}^2$   
Thickness = 11.0 cm

BAR SPACING, cm	BAR DIAMETER, mm				BAR SPACING, cm	BAR DIAMETER, mm			
	6	8	10	12		6	8	10	12
5	15.57	0.00	0.00	0.00	20	4.49	7.62	11.21	14.95
6	13.42	0.00	0.00	0.00	21	4.29	7.29	10.74	14.39
7	11.77	0.00	0.00	0.00	22	0.00	6.98	10.32	13.86
8	10.48	16.67	0.00	0.00	23	0.00	6.70	9.92	13.37
9	9.44	15.21	0.00	0.00	24	0.00	6.44	9.55	12.91
10	8.59	13.97	0.00	0.00	25	0.00	6.20	9.21	12.48
11	7.87	12.91	0.00	0.00	26	0.00	5.97	8.90	12.07
12	7.27	12.00	0.00	0.00	27	0.00	5.77	8.60	11.69
13	6.75	11.20	15.96	0.00	28	0.00	5.57	8.32	11.34
14	6.30	10.50	15.06	0.00	29	0.00	5.39	8.06	11.00
15	5.90	9.88	14.26	0.00	30	0.00	5.22	7.82	10.68
16	5.55	9.33	13.53	0.00	35	0.00	4.51	6.78	9.33
17	5.24	8.83	12.86	0.00	40	0.00	0.00	5.99	8.28
18	4.97	8.39	12.26	16.22	45	0.00	0.00	5.36	7.44
19	4.72	7.99	11.71	15.56					

NOTE 1 — Zeros indicate inadmissible reinforcement percentage.

NOTE 2 — Bar spacings below the dividing line exceed 3d.

$f_y$   
415

$f_{ck}$   
15

$t$   
12  
13

TABLE 17 FLEXURE — MOMENT OF RESISTANCE OF SLABS, kN.m PER METRE WIDTH

$f_{ck} = 15 \text{ N/mm}^2$   
 $f_y = 415 \text{ N/mm}^2$   
Thickness = 12.0 cm

BAR SPACING, cm	BAR DIAMETER, mm				BAR SPACING, cm	BAR DIAMETER, mm			
	6	8	10	12		6	8	10	12
5	17.61	0.00	0.00	0.00	20	0.00	8.53	12.62	16.99
6	15.12	0.00	0.00	0.00	21	0.00	8.15	12.09	16.33
7	13.23	21.00	0.00	0.00	22	0.00	7.80	11.60	15.71
8	11.76	18.94	0.00	0.00	23	0.00	7.49	11.15	15.14
9	10.57	17.23	0.00	0.00	24	0.00	7.19	10.74	14.61
10	9.61	15.79	0.00	0.00	25	0.00	6.92	10.35	14.11
11	8.80	14.56	20.65	0.00	26	0.00	6.67	9.99	13.64
12	8.12	13.51	19.32	0.00	27	0.00	6.44	9.65	13.20
13	7.53	12.59	18.14	0.00	28	0.00	6.22	9.33	12.79
14	7.02	11.79	17.09	0.00	29	0.00	6.02	9.04	12.41
15	6.58	11.09	16.14	0.00	30	0.00	5.83	8.76	12.04
16	6.19	10.46	15.30	20.24	35	0.00	0.00	7.59	10.50
17	5.84	9.90	14.53	19.33	40	0.00	0.00	6.70	9.30
18	5.53	9.40	13.84	18.49	45	0.00	0.00	5.99	8.35
19	5.26	8.94	13.20	17.71					

NOTE 1 — Zeros indicate inadmissible reinforcement percentage.  
NOTE 2 — Bar spacings below the dividing line exceed 3*d*.

TABLE 18 FLEXURE — MOMENT OF RESISTANCE OF SLABS, kN.m PER METRE WIDTH

$f_{ck} = 15 \text{ N/mm}^2$   
 $f_y = 415 \text{ N/mm}^2$   
Thickness = 13.0 cm

BAR SPACING, cm	BAR DIAMETER, mm					BAR SPACING, cm	BAR DIAMETER, mm				
	6	8	10	12	16		6	8	10	12	16
5	19.65	0.00	0.00	0.00	0.00	20	0.00	9.43	14.04	19.04	0.00
6	16.82	0.00	0.00	0.00	0.00	21	0.00	9.01	13.44	18.27	0.00
7	14.69	23.59	0.00	0.00	0.00	22	0.00	8.63	12.89	17.57	0.00
8	13.03	21.21	0.00	0.00	0.00	23	0.00	8.28	12.39	16.92	0.00
9	11.71	19.24	0.00	0.00	0.00	24	0.00	7.95	11.92	16.31	0.00
10	10.63	17.60	24.99	0.00	0.00	25	0.00	7.65	11.48	15.74	0.00
11	9.73	16.21	23.23	0.00	0.00	26	0.00	7.37	11.08	15.21	0.00
12	8.97	15.02	21.68	0.00	0.00	27	0.00	7.11	10.70	14.72	22.92
13	8.32	13.99	20.32	0.00	0.00	28	0.00	6.87	10.33	14.25	22.30
14	7.75	13.09	19.11	0.00	0.00	29	0.00	6.64	10.01	13.81	21.70
15	7.26	12.30	18.03	23.95	0.00	30	0.00	6.43	9.70	13.40	21.13
16	6.83	11.59	17.07	22.79	0.00	35	0.00	0.00	8.40	11.66	18.66
17	6.44	10.97	16.20	21.73	0.00	40	0.00	0.00	7.41	10.32	16.69
18	6.10	10.40	15.41	20.75	0.00	45	0.00	0.00	6.62	9.25	15.09
19	0.00	9.90	14.69	19.86	0.00						

NOTE 1 — Zeros indicate inadmissible reinforcement percentage.  
NOTE 2 — Bar spacings below the dividing line exceed 3*d*.

TABLE 19 FLEXURE — MOMENT OF RESISTANCE OF SLABS, kN.m PER METRE WIDTH

BAR SPACING, cm	BAR DIAMETER, mm					BAR SPACING, cm	BAR DIAMETER, mm				
	6	8	10	12	16		6	8	10	12	16
5	21.69	0.00	0.00	0.00	0.00	20	0.00	10.34	15.46	21.08	0.00
6	18.52	29.54	0.00	0.00	0.00	21	0.00	9.88	14.79	20.22	0.00
7	16.15	26.18	0.00	0.00	0.00	22	0.00	9.45	14.18	19.43	0.00
8	14.31	23.48	0.00	0.00	0.00	23	0.00	9.06	13.62	18.69	0.00
9	12.84	21.26	0.00	0.00	0.00	24	0.00	8.71	13.10	18.01	0.00
10	11.65	19.41	27.82	0.00	0.00	25	0.00	8.37	12.61	17.37	27.18
11	10.65	17.86	25.80	0.00	0.00	26	0.00	8.07	12.17	16.78	26.37
12	9.82	16.33	24.05	0.00	0.00	27	0.00	7.79	11.75	16.23	25.61
13	9.10	15.38	22.50	0.00	0.00	28	0.00	7.52	11.36	15.71	24.89
14	8.48	14.38	21.14	28.14	0.00	29	0.00	7.27	10.99	15.22	24.20
15	7.94	13.51	19.92	26.68	0.00	30	0.00	0.00	10.65	14.76	23.55
16	7.47	12.73	18.84	25.34	0.00	35	0.00	0.00	9.21	12.83	20.74
17	0.00	12.03	17.87	24.13	0.00	40	0.00	0.00	8.12	11.34	18.51
18	0.00	11.41	16.99	23.02	0.00	45	0.00	0.00	7.25	10.16	16.70
19	0.00	10.85	16.19	22.01	0.00						

$f_{ck} = 15 \text{ N/mm}^2$   
 $f_s = 415 \text{ N/mm}^2$   
 Thickness = 14.0 cm

NOTE 1 — Zeros indicate inadmissible reinforcement percentage.

NOTE 2 — Bar spacings below the dividing line exceed  $3d$ .

TABLE 20 FLEXURE — MOMENT OF RESISTANCE OF SLABS, kN.m PER METRE WIDTH

$f_{ck} = 15 \text{ N/mm}^2$   
 $f_y = 415 \text{ N/mm}^2$   
 Thickness = 15.0 cm

BAR SPACING, cm	BAR DIAMETER, mm					
	6	8	10	12	16	18
5	23.73	0.00	0.00	0.00	0.00	0.00
6	20.22	32.56	0.00	0.00	0.00	0.00
7	17.60	28.77	0.00	0.00	0.00	0.00
8	15.58	25.74	0.00	0.00	0.00	0.00
9	13.97	23.27	33.30	0.00	0.00	0.00
10	12.67	21.23	30.66	0.00	0.00	0.00
11	11.58	19.51	28.38	0.00	0.00	0.00
12	10.67	18.04	26.41	0.00	0.00	0.00
13	9.89	16.78	24.68	32.91	0.00	0.00
14	9.21	15.68	23.16	31.06	0.00	0.00
15	8.62	14.72	21.81	29.40	0.00	0.00
16	0.00	13.86	20.61	27.89	0.00	0.00
17	0.00	13.10	19.53	26.53	0.00	0.00
18	0.00	12.42	18.56	25.29	0.00	0.00
19	0.00	11.80	17.68	24.16	0.00	0.00
20	0.00	11.25	16.88	23.12	0.00	0.00
21	0.00	10.74	16.14	22.16	0.00	0.00
22	0.00	10.28	15.47	21.28	0.00	0.00
23	0.00	9.85	14.85	20.47	32.08	0.00
24	0.00	9.46	14.28	19.71	31.03	0.00
25	0.00	9.10	13.75	19.01	30.08	0.00
26	0.00	8.76	13.26	18.35	29.16	0.00
27	0.00	8.45	12.80	17.74	28.30	0.00
28	0.00	0.00	12.37	17.17	27.48	0.00
29	0.00	0.00	11.97	16.63	26.70	31.22
30	0.00	0.00	11.59	16.12	25.97	30.43
35	0.00	0.00	10.02	14.00	22.81	26.97
40	0.00	0.00	8.82	12.36	20.32	24.18
45	0.00	0.00	0.00	11.07	18.31	21.89

NOTE — Zeros indicate inadmissible reinforcement percentage.

415

15

17.5

TABLE 21 FLEXURE — MOMENT OF RESISTANCE OF SLABS, kN.m PER METRE WIDTH

 $f_{ck} = 15 \text{ N/mm}^2$   
 $f_y = 415 \text{ N/mm}^2$   
 Thickness = 17.5 cm

BAR SPACING, cm	BAR DIAMETER, mm.						
	6	8	10	12	16	18	20
5	28.83	46.46	0.00	0.00	0.00	0.00	0.00
6	24.47	40.12	0.00	0.00	0.00	0.00	0.00
7	21.25	35.25	0.00	0.00	0.00	0.00	0.00
8	18.77	31.41	45.24	0.00	0.00	0.00	0.00
9	16.81	28.31	41.17	0.00	0.00	0.00	0.00
10	15.22	25.76	37.74	0.00	0.00	0.00	0.00
11	13.90	23.63	34.82	46.53	0.00	0.00	0.00
12	12.79	21.82	32.31	43.47	0.00	0.00	0.00
13	11.85	20.27	30.13	40.76	0.00	0.00	0.00
14	0.00	18.92	28.22	38.35	0.00	0.00	0.00
15	0.00	17.74	26.54	36.20	0.00	0.00	0.00
16	0.00	16.70	25.04	34.27	0.00	0.00	0.00
17	0.00	15.77	23.70	32.53	0.00	0.00	0.00
18	0.00	14.94	22.50	30.96	0.00	0.00	0.00
19	0.00	14.19	21.41	29.53	46.43	0.00	0.00
20	0.00	13.51	20.42	28.22	44.64	0.00	0.00
21	0.00	12.90	19.52	27.02	42.98	0.00	0.00
22	0.00	12.34	18.69	25.92	41.42	0.00	0.00
23	0.00	11.82	17.93	24.90	39.97	0.00	0.00
24	0.00	0.00	17.23	23.96	38.61	45.35	0.00
25	0.00	0.00	16.58	23.09	37.34	43.97	0.00
26	0.00	0.00	15.98	22.28	36.14	42.66	0.00
27	0.00	0.00	15.42	21.52	35.02	41.43	0.00
28	0.00	0.00	14.90	20.81	33.96	40.25	0.00
29	0.00	0.00	14.41	20.15	32.96	39.14	0.00
30	0.00	0.00	13.96	19.53	32.01	38.08	0.00
35	0.00	0.00	12.05	16.91	27.99	33.53	38.89
40	0.00	0.00	0.00	14.91	24.86	29.92	34.91
45	0.00	0.00	0.00	13.33	22.34	26.99	31.64

Note — Zeros indicate inadmissible reinforcement percentage.

$f_y$   
415

$f_{ck}$   
15

$t$   
20

TABLE 22 FLEXURE — MOMENT OF RESISTANCE OF SLABS, kN.m PER METRE WIDTH

$f_{ck} = 15 \text{ N/mm}^2$   
 $f_y = 415 \text{ N/mm}^2$   
Thickness =  $20\phi$  cm

BAR SPACING, cm	BAR DIAMETER, mm								
	6	8	10	12	16	18	20	22	25
5	33.93	55.53	0.00	0.00	0.00	0.00	0.00	0.00	0.00
6	28.72	47.68	0.00	0.00	0.00	0.00	0.00	0.00	0.00
7	24.89	41.73	60.25	0.00	0.00	0.00	0.00	0.00	0.00
8	21.96	37.08	54.10	0.00	0.00	0.00	0.00	0.00	0.00
9	19.64	33.35	49.05	65.33	0.00	0.00	0.00	0.00	0.00
10	17.77	30.30	44.83	60.22	0.00	0.00	0.00	0.00	0.00
11	16.22	27.75	41.26	55.81	0.00	0.00	0.00	0.00	0.00
12	0.00	25.60	38.22	51.97	0.00	0.00	0.00	0.00	0.00
13	0.00	23.76	35.58	48.60	0.00	0.00	0.00	0.00	0.00
14	0.00	22.16	33.28	45.64	0.00	0.00	0.00	0.00	0.00
15	0.00	20.76	31.26	43.00	0.00	0.00	0.00	0.00	0.00
16	0.00	19.53	29.47	40.65	63.97	0.00	0.00	0.00	0.00
17	0.00	18.44	27.87	38.53	61.08	0.00	0.00	0.00	0.00
18	0.00	17.46	26.43	36.63	58.43	0.00	0.00	0.00	0.00
19	0.00	16.58	25.14	34.90	55.98	0.00	0.00	0.00	0.00
20	0.00	15.78	23.96	33.32	53.71	0.00	0.00	0.00	0.00
21	0.00	0.00	22.89	31.88	51.61	60.92	0.00	0.00	0.00
22	0.00	0.00	21.91	30.56	49.67	58.79	0.00	0.00	0.00
23	0.00	0.00	21.01	29.34	47.86	56.79	0.00	0.00	0.00
24	0.00	0.00	20.18	28.21	46.17	54.92	0.00	0.00	0.00
25	0.00	0.00	19.42	27.17	44.59	53.15	0.00	0.00	0.00
26	0.00	0.00	18.71	26.20	43.12	51.49	59.48	0.00	0.00
27	0.00	0.00	18.05	25.30	41.73	49.93	57.80	0.00	0.00
28	0.00	0.00	17.43	24.45	40.43	48.45	56.20	0.00	0.00
29	0.00	0.00	16.86	23.67	39.21	47.06	54.69	0.00	0.00
30	0.00	0.00	16.32	22.93	38.06	45.74	53.24	0.00	0.00
35	0.00	0.00	0.00	19.83	33.18	40.09	46.98	53.62	0.00
40	0.00	0.00	0.00	17.46	29.39	35.66	41.99	48.21	0.00
45	0.00	0.00	0.00	15.60	26.38	32.10	37.94	43.75	52.03

NOTE — Zeros indicate inadmissible reinforcement percentage.

415

 $f_{ck}$   
15 $t$   
22.5TABLE 23 FLEXURE—MOMENT OF RESISTANCE OF SLABS, kN.m  
PER METRE WIDTH
 $f_{ck} = 15 \text{ N/mm}^2$   
 $f_y = 415 \text{ N/mm}^2$   
 Thickness = 22.5 cm

BAR SPACING, cm	BAR DIAMETER, mm								
	6	8	10	12	16	18	20	22	25
5	39.03	64.59	0.00	0.00	0.00	0.00	0.00	0.00	0.00
6	32.97	55.24	79.65	0.00	0.00	0.00	0.00	0.00	0.00
7	28.34	48.21	70.37	0.00	0.00	0.00	0.00	0.00	0.00
8	25.15	42.75	62.96	84.02	0.00	0.00	0.00	0.00	0.00
9	22.48	38.39	56.92	76.67	0.00	0.00	0.00	0.00	0.00
10	20.32	34.83	51.91	70.43	0.00	0.00	0.00	0.00	0.00
11	0.00	31.88	47.71	65.09	0.00	0.00	0.00	0.00	0.00
12	0.00	29.38	44.12	60.47	0.00	0.00	0.00	0.00	0.00
13	0.00	27.24	41.03	56.45	0.00	0.00	0.00	0.00	0.00
14	0.00	25.40	38.34	52.92	83.48	0.00	0.00	0.00	0.00
15	0.00	23.78	35.98	49.80	79.20	0.00	0.00	0.00	0.00
16	0.00	22.36	33.90	47.02	75.31	0.00	0.00	0.00	0.00
17	0.00	21.10	32.04	44.54	71.75	0.00	0.00	0.00	0.00
18	0.00	19.98	30.37	42.29	68.50	80.96	0.00	0.00	0.00
19	0.00	0.00	28.87	40.27	65.52	77.70	0.00	0.00	0.00
20	0.00	0.00	27.50	38.42	62.78	74.67	0.00	0.00	0.00
21	0.00	0.00	26.26	36.74	60.25	71.85	0.00	0.00	0.00
22	0.00	0.00	25.13	35.19	57.91	69.23	0.00	0.00	0.00
23	0.00	0.00	24.09	33.77	55.74	66.77	77.40	0.00	0.00
24	0.00	0.00	23.14	32.46	53.73	64.48	74.92	0.00	0.00
25	0.00	0.00	22.25	31.25	51.85	62.34	72.59	0.00	0.00
26	0.00	0.00	21.43	30.12	50.09	60.32	70.38	0.00	0.00
27	0.00	0.00	20.67	29.08	48.45	58.43	68.30	0.00	0.00
28	0.00	0.00	19.96	28.10	46.91	56.65	66.33	75.57	0.00
29	0.00	0.00	19.30	27.18	45.47	54.97	64.46	73.58	0.00
30	0.00	0.00	0.00	26.33	44.11	53.39	62.69	71.69	0.00
35	0.00	0.00	0.00	22.74	38.36	46.65	55.08	63.42	0.00
40	0.00	0.00	0.00	20.01	33.93	41.40	49.08	56.79	67.93
45	0.00	0.00	0.00	0.00	30.41	37.20	44.24	51.37	61.87

Note — Zeros indicate inadmissible reinforcement percentage.



$f_y$   
415  
 $f_{ck}$   
15  
 $t$   
25

TABLE 24 FLEXURE — MOMENT OF RESISTANCE OF SLABS, kN.m PER METRE WIDTH

$f_{ck} = 15 \text{ N/mm}^2$   
 $f_y = 415 \text{ N/mm}^2$   
Thickness = 250 mm

BAR SPACING, cm	BAR DIAMETER, mm								
	6	8	10	12	16	18	20	22	25
5	44.14	73.66	105.62	0.00	0.00	0.00	0.00	0.00	0.00
6	37.23	62.80	91.46	0.00	0.00	0.00	0.00	0.00	0.00
7	32.18	54.69	80.50	107.33	0.00	0.00	0.00	0.00	0.00
8	28.34	48.42	71.82	96.78	0.00	0.00	0.00	0.00	0.00
9	25.31	43.43	64.79	88.01	0.00	0.00	0.00	0.00	0.00
10	0.00	39.37	59.00	80.63	0.00	0.00	0.00	0.00	0.00
11	0.00	36.00	54.13	74.36	0.00	0.00	0.00	0.00	0.00
12	0.00	33.16	50.03	68.97	0.00	0.00	0.00	0.00	0.00
13	0.00	30.73	46.48	64.30	102.14	0.00	0.00	0.00	0.00
14	0.00	28.64	43.41	60.21	96.44	0.00	0.00	0.00	0.00
15	0.00	26.81	40.71	56.61	91.29	0.00	0.00	0.00	0.00
16	0.00	25.20	38.33	53.40	86.64	102.61	0.00	0.00	0.00
17	0.00	0.00	36.20	50.54	82.43	97.98	0.00	0.00	0.00
18	0.00	0.00	34.31	47.96	78.58	93.72	0.00	0.00	0.00
19	0.00	0.00	32.60	45.64	75.07	89.78	0.00	0.00	0.00
20	0.00	0.00	31.05	43.52	71.85	86.15	99.95	0.00	0.00
21	0.00	0.00	29.64	41.60	68.89	82.78	96.32	0.00	0.00
22	0.00	0.00	28.35	39.83	66.16	79.66	92.91	0.00	0.00
23	0.00	0.00	27.17	38.21	63.63	76.76	89.72	0.00	0.00
24	0.00	0.00	26.09	36.72	61.28	74.05	86.73	0.00	0.00
25	0.00	0.00	25.09	35.33	59.10	71.52	83.92	95.88	0.00
26	0.00	0.00	24.16	34.05	57.07	69.15	81.28	93.05	0.00
27	0.00	0.00	0.00	32.86	55.17	66.93	78.79	90.37	0.00
28	0.00	0.00	0.00	31.74	53.39	64.85	76.45	87.82	0.00
29	0.00	0.00	0.00	30.70	51.72	62.89	74.23	85.41	0.00
30	0.00	0.00	0.00	29.73	50.15	61.04	72.14	83.12	0.00
35	0.00	0.00	0.00	25.66	43.54	53.21	63.18	73.22	87.82
40	0.00	0.00	0.00	0.00	38.46	47.14	56.17	65.36	79.00
45	0.00	0.00	0.00	0.00	34.44	42.30	50.54	58.99	71.71

NOTE — Zeros indicate inadmissible reinforcement percentage.



$f_y$   
250

$f_{ck}$   
20

$t$   
10  
11

TABLE 25 FLEXURE—MOMENT OF RESISTANCE OF SLABS, kN.m PER METRE WIDTH

$f_{ck} = 20 \text{ N/mm}^2$   
 $f_y = 250 \text{ N/mm}^2$   
Thickness = 10.0 cm

BAR SPACING, cm	BAR DIAMETER, mm				BAR SPACING, cm	BAR DIAMETER, mm			
	6	8	10	12		6	8	10	12
5	9.21	14.94	0.00	0.00	20	0.00	4.25	6.41	8.84
6	7.79	12.84	18.09	0.00	21	0.00	4.06	6.12	8.46
7	6.75	11.24	16.08	0.00	22	0.00	3.88	5.86	8.11
8	5.96	9.99	14.44	0.00	23	0.00	3.72	5.62	7.78
9	5.33	8.98	13.10	17.27	24	0.00	3.57	5.40	7.49
10	4.82	8.16	11.97	15.93	25	0.00	3.43	5.19	7.21
11	4.40	7.48	11.03	14.77	26	0.00	3.30	5.00	6.95
12	4.05	6.90	10.21	13.76	27	0.00	3.18	4.83	6.71
13	3.73	6.40	9.51	12.87	28	0.00	3.07	4.66	6.49
14	3.49	5.97	8.90	12.09	29	0.00	2.97	4.51	6.28
15	3.26	5.59	8.36	11.40	30	0.00	2.87	4.37	6.09
16	3.06	5.26	7.88	10.78	35	0.00	0.00	3.77	5.26
17	2.89	4.97	7.45	10.22	40	0.00	0.00	3.31	4.64
18	2.73	4.70	7.07	9.71					
19	0.00	4.47	6.72	9.26					

NOTE 1 — Zeros indicate inadmissible reinforcement percentage.

NOTE 2 — Bar spacings below the dividing line exceed 3d.

TABLE 26 FLEXURE—MOMENT OF RESISTANCE OF SLABS, kN.m PER METRE WIDTH

$f_{ck} = 20 \text{ N/mm}^2$   
 $f_y = 250 \text{ N/mm}^2$   
Thickness = 11.0 cm

BAR SPACING, cm	BAR DIAMETER, mm				BAR SPACING, cm	BAR DIAMETER, mm			
	6	8	10	12		6	8	10	12
5	10.44	17.13	24.00	0.00	20	0.00	4.80	7.26	10.07
6	8.82	14.66	20.93	0.00	21	0.00	4.58	6.94	9.63
7	7.63	12.80	18.51	0.00	22	0.00	4.38	6.64	9.22
8	6.73	11.35	16.58	21.90	23	0.00	4.19	6.36	8.85
9	6.01	10.20	14.99	20.00	24	0.00	4.02	6.11	8.51
10	5.44	9.25	13.68	18.39	25	0.00	3.87	5.88	8.19
11	4.96	8.47	12.58	17.01	26	0.00	3.72	5.66	7.90
12	4.56	7.81	11.64	15.81	27	0.00	3.59	5.46	7.63
13	4.22	7.24	10.82	14.77	28	0.00	3.46	5.27	7.37
14	3.93	6.75	10.12	13.85	29	0.00	3.35	5.10	7.13
15	3.67	6.32	9.50	13.04	30	0.00	3.24	4.94	6.91
16	3.43	5.95	8.95	12.31	35	0.00	0.00	4.25	5.97
17	3.25	5.61	8.46	11.66	40	0.00	0.00	3.74	5.25
18	0.00	5.31	8.02	11.08	45	0.00	0.00	3.33	4.69
19	0.00	5.04	7.62	10.55					

NOTE 1 — Zeros indicate inadmissible reinforcement percentage.

NOTE 2 — Bar spacings below the dividing line exceed 3d.

$f_y$   
250

$f_{ck}$   
20

$t$   
12  
13

TABLE 27 FLEXURE—MOMENT OF RESISTANCE OF SLABS, kN.m PER METRE WIDTH

$f_{ck} = 20 \text{ N/mm}^2$   
 $f_y = 250 \text{ N/mm}^2$   
Thickness = 12.0 cm

BAR SPACING, cm	BAR DIAMETER, mm				BAR SPACING, cm	BAR DIAMETER, mm			
	6	8	10	12		6	8	10	12
5	11.67	19.31	27.41	0.00	20	0.00	5.35	8.12	11.30
6	9.84	16.48	23.78	0.00	21	0.00	5.10	7.75	10.80
7	8.51	14.36	20.95	27.64	22	0.00	4.87	7.41	10.34
8	7.50	12.72	18.71	24.97	23	0.00	4.67	7.11	9.92
9	6.70	11.41	16.89	22.73	24	9.00	4.48	6.82	9.54
10	6.05	10.35	15.39	20.85	25	0.00	4.30	6.56	9.18
11	5.52	9.46	14.13	19.24	26	0.00	4.14	6.32	8.85
12	5.07	8.72	13.06	17.86	27	0.00	3.99	6.09	8.54
13	4.69	8.08	12.14	16.66	28	0.00	0.00	5.88	8.25
14	4.37	7.53	11.34	15.60	29	0.00	0.00	5.69	7.98
15	4.08	7.05	10.63	14.67	30	0.00	0.00	5.50	7.73
16	0.00	6.63	10.01	13.85	35	0.00	0.00	4.74	6.67
17	0.00	6.25	9.46	13.11	40	0.00	0.00	4.18	5.87
18	0.00	5.92	8.97	12.44	45	0.00	0.00	0.00	5.24
19	0.00	5.62	8.52	11.84					

NOTE 1 — Zeros indicate inadmissible reinforcement percentage.  
NOTE 2 — Bar spacings below the dividing line exceed 3d.

TABLE 28 FLEXURE—MOMENT OF RESISTANCE] OF SLABS, kN.m PER METRE WIDTH

$f_{ck} = 20 \text{ N/mm}^2$   
 $f_y = 250 \text{ N/mm}^2$   
Thickness = 13.0 cm

BAR SPACING, cm	BAR DIAMETER, mm					BAR SPACING, cm	BAR DIAMETER, mm				
	6	8	10	12	16		6	8	10	12	16
5	12.90	21.50	30.83	0.00	0.00	20	0.00	5.89	8.97	12.53	20.41
6	10.87	18.30	26.62	34.96	0.00	21	0.00	5.63	8.56	11.97	19.56
7	9.39	15.92	23.39	31.16	0.00	22	0.00	5.37	8.19	11.46	18.78
8	8.26	14.08	20.84	28.04	0.00	23	0.00	5.14	7.85	10.99	18.06
9	7.38	12.63	18.79	25.47	0.00	24	0.00	4.93	7.53	10.56	17.39
10	6.67	11.44	17.10	23.31	0.00	25	0.00	4.74	7.24	10.16	16.77
11	6.08	10.46	15.68	21.48	33.00	26	0.00	0.00	6.97	9.79	16.19
12	5.57	9.63	14.48	19.91	30.94	27	0.00	0.00	6.72	9.45	15.63
13	5.17	8.92	13.45	18.53	29.11	28	0.00	0.00	6.49	9.13	15.14
14	4.81	8.31	12.56	17.36	27.46	29	0.00	0.00	6.28	8.83	14.66
15	0.00	7.78	11.77	16.31	25.98	30	0.00	0.00	6.07	8.55	14.22
16	0.00	7.31	11.08	15.39	24.65	35	0.00	0.00	5.23	7.37	12.34
17	0.00	6.90	10.47	14.56	23.43	40	0.00	0.00	4.59	6.48	10.89
18	0.00	6.53	9.91	13.81	22.33	45	0.00	0.00	0.00	5.78	9.73
19	0.00	6.19	9.42	13.14	21.33						

NOTE 1 — Zeros indicate inadmissible reinforcement percentage.  
NOTE 2 — Bar spacings below the dividing line exceed 3d.

$f_y$   
250  
 $f_{ck}$   
20  
 $l$   
14  
15

TABLE 29 FLEXURE — MOMENT OF RESISTANCE OF SLABS, kN.m PER METRE WIDTH

$f_{ck} = 20 \text{ N/mm}^2$   
 $f_y = 250 \text{ N/mm}^2$   
Thickness = 14.0 cm

BAR SPACING, cm	BAR DIAMETER, mm					BAR SPACING, cm	BAR DIAMETER, mm				
	6	8	10	12	16		6	8	10	12	16
5	14.12	23.68	34.24	0.00	0.00	20	0.00	0.44	9.82	13.76	22.29
6	11.89	20.12	29.47	39.06	0.00	21	0.00	6.14	9.37	13.14	21.64
7	10.27	17.48	25.83	34.67	0.00	22	0.00	5.87	8.97	12.58	20.77
8	9.03	15.43	22.98	31.12	0.00	23	0.00	5.62	8.39	12.06	19.96
9	8.06	13.84	20.69	28.20	0.00	24	0.00	0.00	8.24	11.53	19.21
10	7.28	12.53	18.80	25.77	39.66	25	0.00	0.00	7.93	11.14	18.51
11	6.64	11.45	17.23	23.71	36.97	26	0.00	0.00	7.63	10.74	17.87
12	6.10	10.54	15.90	21.96	34.99	27	0.00	0.00	7.36	10.36	17.26
13	5.64	9.76	14.76	20.44	32.47	28	0.00	0.00	7.10	10.00	16.70
14	0.00	9.09	13.78	19.12	30.58	29	0.00	0.00	6.86	9.67	16.17
15	0.00	8.51	12.91	17.95	28.90	30	0.00	0.00	6.64	9.36	15.67
16	0.00	7.99	12.15	16.92	27.38	35	0.00	0.00	5.72	8.07	13.59
17	0.00	7.54	11.47	16.00	26.01	40	0.00	0.00	0.00	7.10	11.99
18	0.00	7.13	10.85	15.18	24.76	45	0.00	0.00	0.00	6.33	10.72
19	0.00	6.77	10.32	14.43	23.63						

NOTE 1 — Zeros indicate inadmissible reinforcement percentage.  
NOTE 2 — Bar spacings below the dividing line exceed 3d.

TABLE 30 FLEXURE — MOMENT OF RESISTANCE OF SLABS, kN.m PER METRE WIDTH

$f_{ck} = 20 \text{ N/mm}^2$   
 $f_y = 250 \text{ N/mm}^2$   
Thickness = 15.0 cm

BAR SPACING, cm	BAR DIAMETER, mm				
	6	8	10	12	16
5	15.35	23.87	37.63	49.46	0.00
6	12.92	21.94	32.31	43.16	0.00
7	11.15	19.04	28.27	38.18	0.00
8	9.80	16.82	25.11	34.19	0.00
9	8.75	15.05	22.58	30.93	0.00
10	7.90	13.62	20.51	28.22	44.04
11	7.20	12.44	18.79	25.95	40.94
12	6.61	11.45	17.33	24.00	38.23
13	0.00	10.60	16.08	22.33	35.83
14	0.00	9.87	14.99	20.87	33.71
15	0.00	9.24	14.05	19.59	31.81
16	0.00	8.68	13.21	18.46	30.11
17	0.00	8.18	12.47	17.45	28.58
18	0.00	7.74	11.81	16.54	27.19
19	0.00	7.34	11.22	15.73	25.93
20	0.00	6.98	10.68	14.99	24.78
21	0.00	6.66	10.19	14.31	23.72
22	0.00	6.36	9.74	13.69	22.75
23	0.00	0.00	9.33	13.13	21.86
24	0.00	0.00	8.96	12.61	21.03
25	0.00	0.00	8.61	12.13	20.26
26	0.00	0.00	8.29	11.68	19.55
27	0.00	0.00	7.99	11.27	18.88
28	0.00	0.00	7.71	10.88	18.26
29	0.00	0.00	7.45	10.52	17.68
30	0.00	0.00	7.21	10.18	17.13
35	0.00	0.00	0.00	8.78	14.83
40	0.00	0.00	0.00	7.71	13.08
45	0.00	0.00	0.00	6.88	11.69

NOTE 1 — Zeros indicate inadmissible reinforcement percentage.  
NOTE 2 — Bar spacings below the dividing line exceed 3d.

$f_y$   
250 $f_{ck}$   
20 $t$   
17.5

TABLE 31 FLEXURE—MOMENT OF RESISTANCE OF SLABS, kN.m PER METRE WIDTH

$f_{ck} = 20 \text{ N/mm}^2$   
 $f_y = 250 \text{ N/mm}^2$   
 Thickness = 17.5 cm

$f_{ck} = 20 \text{ N/mm}^2$   
 $f_y = 250 \text{ N/mm}^2$   
 Thickness = 17.5 cm

BAR SPACING, cm	BAR DIAMETER, mm								
	6	8	10	12	16	18	20		
5	18.43	31.33	46.19	61.76	0.00	0.00	0.00		
6	15.48	26.49	39.43	53.40	0.00	0.00	0.00		
7	13.34	22.94	34.37	46.96	0.00	0.00	0.00		
8	11.72	20.23	30.45	41.87	65.25	0.00	0.00		
9	10.45	18.09	27.33	37.76	59.71	0.00	0.00		
10	9.43	16.36	24.78	34.37	54.96	64.19	0.00		
11	0.00	14.93	22.57	31.53	50.88	59.82	0.00		
12	0.00	13.73	20.88	29.13	47.34	55.95	0.00		
13	0.00	12.70	19.36	27.06	44.24	52.52	60.23		
14	0.00	11.82	18.04	25.26	41.51	49.46	56.99		
15	0.00	11.06	16.89	23.69	39.09	46.72	54.04		
16	0.00	10.38	15.88	22.30	36.94	44.26	51.57		
17	0.00	9.79	14.98	21.06	35.00	42.04	48.93		
18	0.00	9.26	14.18	19.96	33.26	40.03	46.70		
19	0.00	8.78	13.46	18.96	31.68	38.19	44.66		
20	0.00	0.00	12.81	18.06	30.24	36.52	42.78		
21	0.00	0.00	12.22	17.24	28.93	34.98	41.05		
22	0.00	0.00	11.68	16.49	27.72	33.56	39.45		
23	0.00	0.00	11.19	15.80	26.61	32.25	37.96		
24	0.00	0.00	10.73	15.17	25.58	31.04	36.58		
25	0.00	0.00	10.32	14.59	24.63	29.92	35.30		
26	0.00	0.00	9.93	14.05	23.75	28.87	34.10		
27	0.00	0.00	9.57	13.54	22.93	27.90	32.98		
28	0.00	0.00	9.24	13.08	22.16	26.99	31.93		
29	0.00	0.00	8.93	12.64	21.45	26.13	30.94		
30	0.00	0.00	0.00	12.23	20.77	25.33	30.02		
35	0.00	0.00	0.00	10.33	17.96	21.95	26.09		
40	0.00	0.00	0.00	9.25	15.81	19.36	23.07		
45	0.00	0.00	0.00	0.00	14.12	17.32	20.68		

NOTE — Zeros indicate inadmissible reinforcement percentage.

$f_y$   
250  
 $f_{ck}$   
20  
 $t$   
20

TABLE 32 FLEXURE—MOMENT OF RESISTANCE OF SLABS, kN.m PER METRE WIDTH

$f_{ck} = 20 \text{ N/mm}^2$   
 $f_y = 250 \text{ N/mm}^2$   
Thickness = 20.0 cm

BAR SPACING, cm	BAR DIAMETER, mm								
	6	8	10	12	16	18	20	22	25
3	21.50	36.80	54.73	74.05	0.00	0.00	0.00	0.00	0.00
6	18.04	31.05	46.54	63.65	0.00	0.00	0.00	0.00	0.00
7	15.34	26.85	40.47	55.74	87.37	0.00	0.00	0.00	0.00
8	13.64	23.65	35.78	49.35	78.91	0.00	0.00	0.00	0.00
9	12.16	21.12	32.07	44.39	71.85	84.51	0.00	0.00	0.00
10	0.00	19.09	29.05	40.52	65.89	78.02	0.00	0.00	0.00
11	0.00	17.41	26.55	37.12	60.81	72.39	83.28	0.00	0.00
12	0.00	16.00	24.44	34.25	56.44	67.47	78.04	0.00	0.00
13	0.00	14.81	22.64	31.79	52.64	63.16	73.36	82.81	0.00
14	0.00	13.78	21.09	29.65	49.32	59.34	69.18	78.44	0.00
15	0.00	12.88	19.74	27.79	46.38	55.94	65.42	74.47	0.00
16	0.00	12.09	18.55	26.14	43.77	52.91	62.04	70.84	0.00
17	0.00	0.00	17.50	24.68	41.43	50.18	58.97	67.53	0.00
18	0.00	0.00	16.55	23.37	39.33	47.71	56.18	64.49	76.03
19	0.00	0.00	15.71	22.20	37.43	45.47	53.64	61.70	73.04
20	0.00	0.00	14.95	21.13	35.70	43.43	51.31	59.14	70.25
21	0.00	0.00	14.25	20.17	34.13	41.56	49.18	56.77	67.66
22	0.00	0.00	13.62	19.28	32.69	39.85	47.21	54.58	65.23
23	0.00	0.00	13.04	18.47	31.36	38.27	45.39	52.54	62.96
24	0.00	0.00	12.51	17.73	30.14	36.81	43.70	50.65	60.83
25	0.00	0.00	12.02	17.05	29.01	35.45	42.13	48.89	58.84
26	0.00	0.00	11.57	16.41	27.95	34.19	40.67	47.24	56.96
27	0.00	0.00	0.00	15.82	26.98	33.02	39.30	45.70	55.20
28	0.00	0.00	0.00	15.27	26.07	31.92	38.03	44.25	53.54
29	0.00	0.00	0.00	14.76	25.21	30.90	36.83	42.90	51.97
30	0.00	0.00	0.00	14.28	24.42	29.94	35.71	41.62	50.49
35	0.00	0.00	0.00	12.29	21.08	25.90	30.97	36.21	44.17
40	0.00	0.00	0.00	0.00	18.54	22.82	27.34	32.04	39.24
45	0.00	0.00	0.00	0.00	16.55	20.39	24.47	28.72	35.29

NOTE — Zeros indicate inadmissible reinforcement percentages.

$f_y$   
250 $f_{ck}$   
20 $l$   
22.5TABLE 33 FLEXURE—MOMENT OF RESISTANCE OF SLABS, kN.m  
PER METRE WIDTH $f_{ck} = 20 \text{ N/mm}^2$   
 $f_y = 250 \text{ N/mm}^2$   
Thickness — 22.5 cm

BAR SPACING, cm	BAR DIAMETER, mm								
	6	8	10	12	16	18	20	22	25
5	24.37	42.26	63.27	86.34	0.00	0.00	0.00	0.00	0.00
6	20.60	35.60	53.66	73.89	115.76	0.00	0.00	0.00	0.00
7	17.73	30.75	45.56	64.52	102.98	0.00	0.00	0.00	0.00
8	15.56	27.06	41.12	57.24	92.57	109.29	0.00	0.00	0.00
9	0.00	24.16	36.81	51.42	83.99	99.87	0.00	0.00	0.00
10	0.00	21.82	33.32	46.66	76.82	91.85	106.23	0.00	0.00
11	0.00	19.89	30.43	42.71	70.75	84.96	98.80	0.00	0.00
12	0.00	18.28	28.00	39.37	65.55	79.00	92.27	104.82	0.00
13	0.00	16.91	25.93	36.52	61.05	73.79	86.50	98.70	0.00
14	0.00	15.73	24.14	34.04	57.12	69.22	81.28	93.20	0.00
15	0.00	0.00	22.39	31.89	53.66	65.16	76.81	88.24	104.15
16	0.00	0.00	21.22	29.98	50.60	61.55	72.71	83.75	99.35
17	0.00	0.00	20.01	28.30	47.86	58.31	69.01	79.68	94.93
18	0.00	0.00	18.93	26.79	45.40	55.39	65.67	75.97	90.85
19	0.00	0.00	17.96	25.43	43.18	52.75	62.63	72.58	87.08
20	0.00	0.00	17.08	24.21	41.17	50.35	59.85	69.47	83.59
21	0.00	0.00	16.29	23.09	39.33	48.15	57.31	66.61	80.36
22	0.00	0.00	15.56	22.08	37.65	46.13	54.97	63.97	77.35
23	0.00	0.00	14.90	21.15	36.11	44.28	52.81	61.53	74.56
24	0.00	0.00	0.00	20.29	34.69	42.57	50.81	59.26	71.95
25	0.00	0.00	0.00	19.50	33.38	40.98	48.96	57.15	69.51
26	0.00	0.00	0.00	18.77	32.16	39.51	47.24	55.19	67.22
27	0.00	0.00	0.00	18.10	31.02	38.14	45.63	53.35	65.08
28	0.00	0.00	0.00	17.47	29.97	36.86	44.13	51.63	63.07
29	0.00	0.00	0.00	16.88	28.98	35.67	42.72	50.02	61.17
30	0.00	0.00	0.00	16.33	28.06	34.55	41.40	48.50	59.38
35	0.00	0.00	0.00	0.00	24.20	29.85	35.85	42.11	51.80
40	0.00	0.00	0.00	0.00	21.27	26.28	31.61	37.20	45.91
45	0.00	0.00	0.00	0.00	18.98	23.47	28.26	33.31	41.21

Note — Zeros indicate inadmissible reinforcement percentage.

$f_y$   
250

$f_{ck}$   
20

$t$   
25

TABLE 34 FLEXURE — MOMENT OF RESISTANCE OF SLABS, kN.m PER METRE WIDTH

$f_{ck} = 20 \text{ N/mm}^2$   
 $f_y = 250 \text{ N/mm}^2$   
Thickness = 25.0 cm

BAR SPACING, cm	BAR DIAMETER, mm								
	6	8	10	12	16	18	20	22	25
5	27.65	47.72	71.80	98.64	0.00	0.00	0.00	0.00	0.00
6	23.16	40.15	60.77	84.14	133.98	0.00	0.00	0.00	0.00
7	19.93	34.65	52.66	73.30	118.59	140.15	0.00	0.00	0.00
8	0.00	30.47	46.46	64.92	106.23	126.58	0.00	0.00	0.00
9	0.00	27.20	41.55	58.25	96.13	115.24	133.67	0.00	0.00
10	0.00	24.55	37.59	52.81	87.74	105.68	123.40	139.87	0.00
11	0.00	22.38	34.31	48.30	80.68	97.53	114.32	130.41	0.00
12	0.00	20.56	31.56	44.49	74.65	90.52	106.49	122.04	0.00
13	0.00	19.01	29.21	41.24	69.46	84.43	99.63	114.59	0.00
14	0.00	0.00	27.19	38.43	64.93	79.09	93.57	107.96	128.41
15	0.00	0.00	25.43	35.98	60.95	74.38	88.19	102.01	121.93
16	0.00	0.00	23.89	33.83	57.43	70.19	83.38	96.66	116.03
17	0.00	0.00	22.52	31.91	54.29	66.45	79.06	91.83	110.63
18	0.00	0.00	21.30	30.20	51.47	63.08	75.15	87.45	105.67
19	0.00	0.00	20.20	28.67	48.93	60.03	71.61	83.45	101.12
20	0.00	0.00	19.21	27.28	46.63	57.26	68.39	79.80	96.93
21	0.00	0.00	0.00	26.02	44.54	54.73	65.44	76.45	93.06
22	0.00	0.00	0.00	24.87	42.62	52.42	62.73	73.36	89.48
23	0.00	0.00	0.00	23.82	40.86	50.29	60.23	70.51	86.16
24	0.00	0.00	0.00	22.85	39.24	48.33	57.93	67.87	83.06
25	0.00	0.00	0.00	21.96	37.75	46.52	55.79	65.42	80.18
26	0.00	0.00	0.00	21.14	36.36	44.83	53.80	63.13	77.48
27	0.00	0.00	0.00	20.37	35.07	43.26	51.95	61.00	74.96
28	0.00	0.00	0.00	19.66	33.87	41.80	50.22	59.01	72.59
29	0.00	0.00	0.00	19.00	32.75	40.44	48.61	57.14	70.37
30	0.00	0.00	0.00	18.38	31.70	39.16	47.09	55.39	68.28
35	0.00	0.00	0.00	0.00	27.32	33.80	40.73	48.01	59.42
40	0.00	0.00	0.00	0.00	24.01	29.74	35.88	42.36	52.58
45	0.00	0.00	0.00	0.00	21.41	26.54	32.06	37.90	47.14

Note — Zeros indicate inadmissible reinforcement percentage.



$f_y$   
415

$f_{ck}$   
20

$t$   
10  
11

TABLE 35 FLEXURE—MOMENT OF RESISTANCE OF SLABS, kN.m PER METRE WIDTH

$f_{ck} = 20 \text{ N/mm}^2$   
 $f_y = 415 \text{ N/mm}^2$   
Thickness = 10.0 cm

BAR SPACING, cm	BAR DIAMETER, mm				BAR SPACING, cm	BAR DIAMETER, mm			
	6	8	10	12		6	8	10	12
5	14.33	0.00	0.00	0.00	20	4.03	6.87	10.18	13.72
6	12.27	0.00	0.00	0.00	21	3.85	6.57	9.74	13.17
7	10.72	17.11	0.00	0.00	22	3.68	6.29	9.35	12.67
8	9.52	15.40	0.00	0.00	23	3.52	6.03	8.98	12.20
9	8.55	13.98	0.00	0.00	24	0.00	5.79	8.64	11.76
10	7.77	12.79	0.00	0.00	25	0.00	5.57	8.33	11.36
11	7.11	11.79	16.78	0.00	26	0.00	5.37	8.03	10.98
12	6.55	10.92	15.67	0.00	27	0.00	5.18	7.76	10.62
13	6.08	10.18	14.70	0.00	28	0.00	5.00	7.51	10.29
14	5.67	9.52	13.83	0.00	29	0.00	4.84	7.27	9.97
15	5.31	8.95	13.05	17.22	30	0.00	4.69	7.04	9.68
16	4.99	8.44	12.36	16.39	35	0.00	4.04	6.10	8.43
17	4.71	7.99	11.73	15.64	40	0.00	3.55	5.38	7.46
18	4.46	7.58	11.16	14.94					
19	4.24	7.21	10.65	14.30					

NOTE 1 — Zero indicate inadmissible reinforcement percentage.

NOTE 2 — Bar spacings below the dividing line exceed  $3d$ .

TABLE 36 FLEXURE—MOMENT OF RESISTANCE OF SLABS, kN.m PER METRE WIDTH

$f_{ck} = 20 \text{ N/mm}^2$   
 $f_y = 415 \text{ N/mm}^2$   
Thickness = 11.0 cm

BAR SPACING, cm	BAR DIAMETER, mm				BAR SPACING, cm	BAR DIAMETER, mm			
	6	8	10	12		6	8	10	12
5	16.37	0.00	0.00	0.00	20	4.54	7.78	11.59	15.76
6	13.97	22.23	0.00	0.00	21	4.33	7.43	11.09	15.11
7	12.18	19.70	0.00	0.00	22	0.00	7.11	10.64	14.52
8	10.79	17.66	0.00	0.00	23	0.00	6.82	10.21	13.97
9	9.69	15.99	0.00	0.00	24	0.00	6.55	9.82	13.46
10	8.79	14.61	20.87	0.00	25	0.00	6.30	9.46	12.99
11	8.04	13.44	19.35	0.00	26	0.00	6.07	9.12	12.55
12	7.40	12.44	18.03	0.00	27	0.00	5.85	8.81	12.13
13	6.86	11.57	16.88	0.00	28	0.00	5.65	8.52	11.75
14	6.40	10.82	15.85	21.04	29	0.00	5.47	8.24	11.38
15	5.99	10.16	14.94	19.94	30	0.00	5.29	7.99	11.04
16	5.63	9.57	14.13	18.94	35	0.00	4.56	6.91	9.39
17	5.31	9.05	13.40	18.04	40	0.00	0.00	6.09	8.48
18	5.03	8.58	12.74	17.21	45	0.00	0.00	5.44	7.60
19	4.77	8.16	12.14	16.45					

NOTE 1 — Zero indicate inadmissible reinforcement percentage.

NOTE 2 — Bar spacings below the dividing line exceed  $3d$ .



415

 $f_{ck}$   
20 $f_y$   
12  
13TABLE 37 FLEXURE—MOMENT OF RESISTANCE OF SLABS, kN.m  
PER METRE WIDTH $f_{ck} = 20 \text{ N/mm}^2$   
 $f_y = 415 \text{ N/mm}^2$   
Thickness = 12.0 cm

BAR SPACING, cm	BAR DIAMETER, mm				BAR SPACING, cm	BAR DIAMETER, mm			
	6	8	10	12		6	8	10	12
5	18.41	0.00	0.00	0.00	20	0.00	8.69	13.01	17.80
6	15.67	25.25	0.00	0.00	21	0.00	8.29	12.44	17.06
7	13.64	22.29	0.00	0.00	22	0.00	7.93	11.92	16.38
8	12.07	19.93	0.00	0.00	23	0.00	7.61	11.45	15.75
9	10.32	18.01	25.76	0.00	24	0.00	7.30	11.00	15.16
10	9.81	16.42	23.70	0.00	25	0.00	7.02	10.59	14.62
11	8.96	15.08	21.93	0.00	26	0.00	6.77	10.21	14.12
12	8.26	13.95	20.40	26.99	27	0.00	6.52	9.86	13.64
13	7.65	12.97	19.06	25.39	28	0.00	6.30	9.53	13.20
14	7.13	12.12	17.88	23.95	29	0.00	6.09	9.22	12.79
15	6.67	11.37	16.83	22.66	30	0.00	5.90	8.93	12.40
16	6.27	10.71	15.90	21.49	35	0.00	0.00	7.72	10.76
17	5.91	10.12	15.07	20.44	40	0.00	0.00	6.80	9.50
18	5.60	9.59	14.31	19.48	45	0.00	0.00	6.07	8.50
19	5.31	9.12	13.63	18.60					

NOTE 1 — Zeros indicate inadmissible reinforcement percentage.

NOTE 2 — Bar spacings below the dividing line exceed 3d.

TABLE 38 FLEXURE—MOMENT OF RESISTANCE OF SLABS, kN.m  
PER METRE WIDTH $f_{ck} = 20 \text{ N/mm}^2$   
 $f_y = 415 \text{ N/mm}^2$   
Thickness = 13.0 cm

BAR SPACING, cm	BAR DIAMETER, mm					BAR SPACING, cm	BAR DIAMETER, mm				
	6	8	10	12	16		6	8	10	12	16
5	20.45	32.66	0.00	0.00	0.00	20	0.00	9.59	14.43	19.84	30.85
6	17.38	28.28	0.00	0.00	0.00	21	0.00	9.16	13.79	19.00	29.73
7	15.10	24.88	0.00	0.00	0.00	22	0.00	8.76	13.21	18.23	28.67
8	13.34	22.20	31.72	0.00	0.00	23	0.00	8.39	12.68	17.52	27.69
9	11.95	20.02	28.91	0.00	0.00	24	0.00	8.06	12.18	16.87	26.77
10	10.83	18.23	26.54	0.00	0.00	25	0.00	7.75	11.73	16.25	25.90
11	9.89	16.73	24.51	32.49	0.00	26	0.00	7.46	11.30	15.69	25.08
12	9.11	15.46	22.76	30.39	0.00	27	0.00	7.20	10.91	15.16	24.31
13	8.43	14.36	21.24	28.53	0.00	28	0.00	6.95	10.54	14.66	23.59
14	7.86	13.41	19.90	26.87	0.00	29	0.00	6.72	10.20	14.20	22.90
15	7.35	12.58	18.72	25.38	0.00	30	0.00	6.50	9.88	13.76	22.26
16	6.91	11.84	17.67	24.04	0.00	35	0.00	0.00	8.53	11.92	19.49
17	6.51	11.19	16.73	22.84	0.00	40	0.00	0.00	7.50	10.52	17.33
18	6.16	10.60	15.89	21.74	0.00	45	0.00	0.00	6.70	9.41	15.59
19	0.00	10.07	15.12	20.75	0.00						

NOTE 1 — Zeros indicate inadmissible reinforcement percentage.

NOTE 2 — Bar spacings below the dividing line exceed 3d.

$f_y$   
415  
 $f_{ck}$   
20  
 $r$   
14

TABLE 39 FLEXURE — MOMENT OF RESISTANCE OF SLABS, kN.m PER METRE WIDTH

$f_{ck} = 20 \text{ N/mm}^2$   
 $f_y = 415 \text{ N/mm}^2$   
Thickness = 140 cm

BAR SPACING, cm	BAR DIAMETER, mm					BAR SPACING, cm	BAR DIAMETER, mm				
	6	8	10	12	16		6	8	10	12	16
5	22.49	36.29	0.00	0.00	0.00	20	0.00	10.50	15.85	21.88	34.48
6	19.08	31.30	0.00	0.00	0.00	21	0.00	10.02	15.14	20.95	33.18
7	16.36	27.48	39.12	0.00	0.00	22	0.00	9.58	14.50	20.09	31.97
8	14.62	24.47	35.26	0.00	0.00	23	0.00	9.18	13.91	19.30	30.84
9	13.09	22.04	32.06	0.00	0.00	24	0.00	8.82	13.37	18.57	29.79
10	11.85	20.05	29.37	38.94	0.00	25	0.00	8.48	12.86	17.89	28.80
11	10.82	18.38	27.08	36.20	0.00	26	0.00	8.16	12.39	17.26	27.87
12	9.96	16.97	25.12	33.79	0.00	27	0.00	7.87	11.96	16.67	27.00
13	9.22	15.76	23.42	31.67	0.00	28	0.00	7.60	11.55	16.12	26.18
14	8.58	14.71	21.93	29.78	0.00	29	0.00	7.34	11.18	15.60	25.41
15	8.03	13.79	20.61	28.10	0.00	30	0.00	0.00	10.82	15.12	24.68
16	7.55	12.98	19.44	26.60	0.00	35	0.00	0.00	9.34	13.09	21.56
17	0.00	12.25	18.40	25.24	0.00	40	0.00	0.00	8.21	11.54	19.14
18	0.00	11.61	17.46	24.01	0.00	45	0.00	0.00	7.33	10.32	17.20
19	0.00	11.03	16.61	22.90	35.87						

NOTE 1 — Zeros indicate inadmissible reinforcement percentage.

NOTE 2 — Bar spacings below the dividing line exceed  $3d$ .

415

20

15

TABLE 40 FLEXURE—MOMENT OF RESISTANCE OF SLABS, kN.m PER METRE WIDTH

 $f_{ck} = 20 \text{ N/mm}^2$   
 $f_y = 415 \text{ N/mm}^2$   
 Thickness = 15.0 cm

BAR SPACING, cm	BAR DIAMETER, mm					
	6	8	10	12	16	18
5	24.53	39.92	0.00	0.00	0.00	0.00
6	20.78	34.33	0.00	0.00	0.00	0.00
7	18.01	30.07	43.16	0.00	0.00	0.00
8	15.90	26.73	38.80	0.00	0.00	0.00
9	14.22	24.06	35.21	0.00	0.00	0.00
10	12.87	21.86	32.20	43.03	0.00	0.00
11	11.75	20.03	29.66	39.91	0.00	0.00
12	10.81	18.48	27.48	37.19	0.00	0.00
13	10.00	17.15	25.60	34.80	0.00	0.00
14	9.31	16.00	23.95	32.70	0.00	0.00
15	8.71	15.00	22.50	30.82	0.00	0.00
16	0.00	14.11	21.22	29.15	0.00	0.00
17	0.00	13.32	20.07	27.64	43.25	0.00
18	0.00	12.61	19.04	26.28	41.40	0.00
19	0.00	11.98	18.11	25.04	39.69	0.00
20	0.00	11.41	17.26	23.92	38.11	0.00
21	0.00	10.88	16.49	22.89	36.64	0.00
22	0.00	10.41	15.79	21.94	35.27	41.27
23	0.00	9.97	15.14	21.07	34.00	39.90
24	0.00	9.57	14.55	20.27	32.81	38.60
25	0.00	9.20	14.00	19.52	31.70	37.38
26	0.00	8.86	13.48	18.83	30.66	36.24
27	0.00	8.54	13.01	18.18	29.69	35.15
28	0.00	0.00	12.57	17.58	28.77	34.13
29	0.00	0.00	12.15	17.01	27.91	33.16
30	0.00	0.00	11.77	16.48	27.09	32.24
35	0.00	0.00	10.15	14.26	23.64	28.29
40	0.00	0.00	8.92	12.56	20.95	25.19
45	0.00	0.00	0.00	11.22	18.81	22.69

NOTE 1 — Zeros indicate inadmissible reinforcement percentage.

NOTE 2 — Bar spacings below the dividing line exceed 3d.



$f_y$   
415 $f_{ck}$   
20 $t$   
17.5TABLE 41 FLEXURE — MOMENT OF RESISTANCE OF SLABS, kN.m  
PER METRE WIDTH $f_{ck} = 20 \text{ N/mm}^2$   
 $f_y = 415 \text{ N/mm}^2$   
Thickness — 17.5 cm

BAR SPACING, cm	BAR DIAMETER, mm						
	6	8	10	12	16	18	20
5	29.63		0.00	0.00	0.00	0.00	0.00
6	25.03	48.99	60.33	0.00	0.00	0.00	0.00
7	21.96	41.88	53.29	0.00	0.00	0.00	0.00
8	19.08	36.55	47.66	63.53	0.00	0.00	0.00
9	17.06	32.40	43.08	57.95	0.00	0.00	0.00
10	15.42	29.09	39.29	53.23	0.00	0.00	0.00
11	14.07	26.40	36.10	49.18	0.00	0.00	0.00
12	12.93	24.15	33.39	45.69	0.00	0.00	0.00
13	11.97	22.26	31.05	42.65	0.00	0.00	0.00
14	0.00	20.64	29.01	39.98	62.74	0.00	0.00
15	0.00	19.24	27.22	37.62	59.52	0.00	0.00
16	0.00	18.02	25.64	35.52	56.59	0.00	0.00
17	0.00	16.94	24.24	33.64	53.92	0.00	0.00
18	0.00	15.99	22.97	31.95	51.48	60.47	0.00
19	0.00	15.13	21.84	30.41	49.24	58.03	0.00
20	0.00	14.37	20.81	29.02	47.18	55.77	0.00
21	0.00	13.67	19.87	27.75	45.27	53.67	0.00
22	0.00	13.04	19.01	26.58	43.52	51.71	0.00
23	0.00	12.47	18.22	25.51	41.89	49.88	57.43
24	0.00	11.94	17.50	24.52	40.37	48.17	55.60
25	0.00	0.00	16.83	23.60	38.96	46.57	53.87
26	0.00	0.00	16.21	22.75	37.64	45.07	52.24
27	0.00	0.00	15.63	21.96	36.41	43.65	50.70
28	0.00	0.00	15.10	21.22	35.25	42.32	49.24
29	0.00	0.00	14.60	20.53	34.16	41.07	47.86
30	0.00	0.00	14.13	19.88	33.14	39.89	46.54
35	0.00	0.00	12.17	17.17	28.82	34.85	40.91
40	0.00	0.00	0.00	15.11	25.49	30.93	36.46
45	0.00	0.00	0.00	13.49	22.84	27.80	32.86

NOTE — Zeros indicate inadmissible reinforcement percentage.

$f_y$   
415  
 $f_{ck}$   
20  
 $t$   
20

TABLE 42 FLEXURE — MOMENT OF RESISTANCE OF SLABS, kN.m PER METRE WIDTH

$f_{ck} = 20 \text{ N/mm}^2$   
 $f_y = 415 \text{ N/mm}^2$   
Thickness — 20.0 cm

BAR SPACING, cm	BAR DIAMETER, mm								
	6	8	10	12	16	18	20	22	25
5	34.73	58.06	83.47	0.00	0.00	0.00	0.00	0.00	0.00
6	39.28	49.44	72.14	0.00	0.00	0.00	0.00	0.00	0.00
7	25.30	43.02	63.41	84.72	0.00	0.00	0.00	0.00	0.00
8	22.27	38.07	56.52	76.28	0.00	0.00	0.00	0.00	0.00
9	19.89	34.13	50.96	69.29	0.00	0.00	0.00	0.00	0.00
10	17.97	30.93	46.38	63.43	0.00	0.00	0.00	0.00	0.00
11	16.38	28.28	42.54	58.46	0.00	0.00	0.00	0.00	0.00
12	0.00	26.04	39.29	54.20	85.29	0.00	0.00	0.00	0.00
13	0.00	24.13	36.50	50.50	80.23	0.00	0.00	0.00	0.00
14	0.00	22.48	34.07	47.27	75.70	0.00	0.00	0.00	0.00
15	0.00	21.04	31.95	44.43	71.62	0.00	0.00	0.00	0.00
16	0.00	19.78	30.07	41.90	67.93	80.26	0.00	0.00	0.00
17	0.00	18.66	28.40	39.64	64.59	76.59	0.00	0.00	0.00
18	0.00	17.65	26.91	37.62	61.56	73.22	0.00	0.00	0.00
19	0.00	16.75	25.57	35.78	58.79	70.12	0.00	0.00	0.00
20	0.00	15.94	24.35	34.12	56.25	67.25	77.80	0.00	0.00
21	0.00	0.00	23.24	32.61	53.91	64.60	74.94	0.00	0.00
22	0.00	0.00	22.23	31.22	51.76	62.15	72.26	0.00	0.00
23	0.00	0.00	21.30	29.94	49.77	59.86	69.76	0.00	0.00
24	0.00	0.00	20.45	28.77	47.93	57.74	67.41	76.58	0.00
25	0.00	0.00	19.66	27.68	46.21	55.75	65.21	74.24	0.00
26	0.00	0.00	18.94	26.67	44.62	53.89	63.14	72.03	0.00
27	0.00	0.00	18.26	25.74	43.12	52.16	61.19	69.93	0.00
28	0.00	0.00	17.63	24.86	41.73	50.52	59.36	67.95	0.00
29	0.00	0.00	17.04	24.05	40.42	48.99	57.63	66.07	0.00
30	0.00	0.00	16.49	23.28	39.19	47.54	55.99	64.28	0.00
35	0.00	0.00	0.00	20.09	34.00	41.41	49.00	56.58	67.44
40	0.00	0.00	0.00	17.66	30.02	36.67	43.54	50.48	60.63
45	0.00	0.00	0.00	15.76	26.88	32.90	39.16	45.54	55.01

NOTE — Zeros indicate inadmissible reinforcement percentage.



$f_y$   
415  
 $f_{ck}$   
20  
 $t$   
22.

TABLE 43 FLEXURE — MOMENT OF RESISTANCE OF SLABS, kN.m PER METRE WIDTH

$f_{ck} = 20 \text{ N/mm}^2$   
 $f_y = 415 \text{ N/mm}^2$   
Thickness = 22.5 cm

BAR SPACING, cm	BAR DIAMETER, mm									
	6	8	10	12	16	18	20	22	25	
5	39.84	67.13	97.64	0.00	0.00	0.00	0.00	0.00	0.00	
6	33.53	57.00	83.94	112.03	0.00	0.00	0.00	0.00	0.00	
7	28.95	49.50	73.53	99.30	0.00	0.00	0.00	0.00	0.00	
8	25.46	43.74	65.38	89.04	0.00	0.00	0.00	0.00	0.00	
9	22.73	39.17	58.83	80.63	0.00	0.00	0.00	0.00	0.00	
10	20.52	35.47	53.46	73.64	0.00	0.00	0.00	0.00	0.00	
11	0.00	32.40	48.98	67.74	107.44	0.00	0.00	0.00	0.00	
12	0.00	29.82	45.20	62.70	100.41	0.00	0.00	0.00	0.00	
13	0.00	27.62	41.95	58.35	94.19	0.00	0.00	0.00	0.00	
14	0.00	25.72	39.13	54.56	88.65	105.02	0.00	0.00	0.00	
15	0.00	24.07	36.67	51.23	83.71	99.56	0.00	0.00	0.00	
16	0.00	22.61	34.50	48.28	79.27	94.61	0.00	0.00	0.00	
17	0.00	21.32	32.57	45.65	75.26	90.10	104.35	0.00	0.00	
18	0.00	20.17	30.85	43.28	71.63	85.98	99.90	0.00	0.00	
19	0.00	0.00	29.29	41.15	68.33	82.20	95.78	0.00	0.00	
20	0.00	0.00	27.89	39.22	65.32	78.73	91.97	0.00	0.00	
21	0.00	0.00	26.62	37.46	62.55	75.53	88.43	100.77	0.00	
22	0.00	0.00	25.45	35.86	60.01	72.58	85.14	97.26	0.00	
23	0.00	0.00	24.38	34.38	57.66	69.84	82.08	93.96	0.00	
24	0.00	0.00	23.40	33.02	55.40	67.30	79.22	90.67	0.00	
25	0.00	0.00	22.50	31.76	53.27	64.93	76.55	87.96	0.00	
26	0.00	0.00	21.66	30.60	51.29	62.72	74.04	85.22	0.00	
27	0.00	0.00	20.88	29.52	49.44	60.66	71.69	82.63	0.00	
28	0.00	0.00	20.16	28.51	47.71	58.72	69.48	80.20	95.50	
29	0.00	0.00	19.48	27.57	46.07	56.90	67.40	77.89	92.97	
30	0.00	0.00	0.00	26.68	45.23	55.19	65.44	75.71	90.57	
35	0.00	0.00	0.00	23.00	39.19	47.97	57.10	66.38	80.10	
40	0.00	0.00	0.00	20.21	34.56	42.41	50.63	59.05	71.70	
45	0.00	0.00	0.00	0.00	30.91	38.00	45.46	53.16	64.86	

NOTE — Zeros indicate inadmissible reinforcement percentage.

415

 $f_{ck}$   
20 $f_y$   
25TABLE 44 FLEXURE — MOMENT OF RESISTANCE OF SLABS, kN.m  
PER METRE WIDTH $f_{ck} = 20 \text{ N/mm}^2$   
 $f_y = 415 \text{ N/mm}^2$   
Thickness = 25.0 cm

BAR SPACING, cm	BAR DIAMETER, mm								
	6	8	10	12	16	18	20	22	25
5	44.94	76.20	111.81	0.00	0.00	0.00	0.00	0.00	0.00
6	37.78	64.56	95.75	129.04	0.00	0.00	0.00	0.00	0.00
7	32.59	55.98	83.65	113.88	0.00	0.00	0.00	0.00	0.00
8	28.65	49.41	74.23	101.79	0.00	0.00	0.00	0.00	0.00
9	25.56	44.21	66.70	91.97	0.00	0.00	0.00	0.00	0.00
10	0.00	40.00	60.55	83.84	133.56	0.00	0.00	0.00	0.00
11	0.00	36.52	55.43	77.01	123.93	0.00	0.00	0.00	0.00
12	0.00	33.60	51.10	71.20	115.53	136.82	0.00	0.00	0.00
13	0.00	31.11	47.40	66.20	108.14	128.69	0.00	0.00	0.00
14	0.00	28.96	44.19	61.85	101.61	121.41	0.00	0.00	0.00
15	0.00	27.09	41.40	58.03	95.80	114.87	133.27	0.00	0.00
16	0.00	25.45	38.93	54.65	90.61	108.96	126.88	0.00	0.00
17	0.00	0.00	36.74	51.65	85.93	103.60	121.02	0.00	0.00
18	0.00	0.00	34.78	48.95	81.71	98.73	115.64	0.00	0.00
19	0.00	0.00	33.02	46.52	77.88	94.28	110.70	126.55	0.00
20	0.00	0.00	31.43	44.33	74.39	90.21	106.14	121.66	0.00
21	0.00	0.00	29.99	42.32	71.19	86.47	101.93	117.10	0.00
22	0.00	0.00	28.67	40.49	68.25	83.02	98.03	112.84	0.00
23	0.00	0.00	27.47	38.82	65.55	79.83	94.40	108.87	0.00
24	0.00	0.00	26.36	37.27	63.04	76.87	91.03	105.16	0.00
25	0.00	0.00	25.33	35.85	60.73	74.12	87.88	101.67	121.56
26	0.00	0.00	24.39	34.52	58.57	71.55	84.94	98.41	117.96
27	0.00	0.00	0.00	33.30	56.56	69.16	82.19	95.34	114.55
28	0.00	0.00	0.00	32.15	54.68	66.92	79.60	92.45	111.31
29	0.00	0.00	0.00	31.08	52.93	64.82	77.18	89.72	108.24
30	0.00	0.00	0.00	30.08	51.28	62.85	74.89	87.15	105.33
35	0.00	0.00	0.00	25.92	44.37	54.53	65.20	76.18	92.75
40	0.00	0.00	0.00	0.00	39.09	48.15	57.71	67.62	82.78
45	0.00	0.00	0.00	0.00	34.94	43.10	51.76	60.78	74.70

NOTE — Zeros indicate inadmissible reinforcement percentage.

TABLE 45 FLEXURE—REINFORCEMENT PERCENTAGES FOR DOUBLY REINFORCED SECTIONS

$f_{ck} = 15 \text{ N/mm}^2$   
 $f_y = 250 \text{ N/mm}^2$

$M_u/d^2$ , $\text{N/mm}^2$	$d'/d = 0.05$		$d'/d = 0.10$		$d'/d = 0.15$		$d'/d = 0.20$	
	$P_t$	$P_c$	$P_t$	$P_c$	$P_t$	$P_c$	$P_t$	$P_c$
2.24	1.322	0.002	1.322	0.003	1.323	0.003	1.323	0.003
2.25	1.327	0.007	1.328	0.008	1.328	0.008	1.328	0.009
2.30	1.351	0.032	1.353	0.034	1.355	0.036	1.357	0.039
2.35	1.376	0.057	1.379	0.061	1.382	0.064	1.386	0.068
2.40	1.400	0.082	1.404	0.087	1.409	0.092	1.415	0.098
2.45	1.424	0.107	1.430	0.113	1.436	0.120	1.443	0.128
2.50	1.448	0.132	1.455	0.140	1.463	0.148	1.472	0.157
2.55	1.472	0.157	1.481	0.166	1.490	0.176	1.501	0.187
2.60	1.497	0.182	1.506	0.192	1.517	0.204	1.530	0.217
2.65	1.521	0.207	1.532	0.219	1.544	0.232	1.558	0.246
2.70	1.545	0.232	1.558	0.245	1.571	0.260	1.587	0.276
2.75	1.569	0.257	1.583	0.272	1.599	0.288	1.616	0.305
2.80	1.593	0.282	1.609	0.298	1.626	0.315	1.645	0.335
2.85	1.618	0.307	1.634	0.324	1.653	0.343	1.673	0.365
2.90	1.642	0.332	1.660	0.351	1.680	0.371	1.702	0.394
2.95	1.666	0.357	1.685	0.377	1.707	0.399	1.731	0.424
3.00	1.690	0.382	1.711	0.403	1.734	0.427	1.760	0.454
3.05	1.714	0.407	1.736	0.430	1.761	0.455	1.788	0.483
3.10	1.739	0.432	1.762	0.456	1.788	0.483	1.817	0.513
3.15	1.763	0.457	1.788	0.482	1.815	0.511	1.846	0.543
3.20	1.787	0.482	1.813	0.509	1.842	0.539	1.875	0.572
3.25	1.811	0.507	1.839	0.535	1.869	0.567	1.903	0.602
3.30	1.836	0.532	1.864	0.562	1.896	0.595	1.932	0.632
3.35	1.860	0.557	1.890	0.588	1.923	0.623	1.961	0.661
3.40	1.884	0.582	1.915	0.614	1.950	0.650	1.990	0.691
3.45	1.908	0.607	1.941	0.641	1.977	0.678	2.018	0.721
3.50	1.932	0.632	1.966	0.667	2.004	0.706	2.047	0.750
3.55	1.957	0.657	1.992	0.693	2.031	0.734	2.076	0.780
3.60	1.981	0.682	2.018	0.720	2.059	0.762	2.105	0.810
3.65	2.005	0.707	2.043	0.746	2.086	0.790	2.133	0.839
3.70	2.029	0.732	2.069	0.773	2.113	0.818	2.162	0.869
3.75	2.053	0.757	2.094	0.799	2.140	0.846	2.191	0.899
3.80	2.078	0.782	2.120	0.825	2.167	0.874	2.220	0.928
3.85	2.102	0.807	2.145	0.852	2.194	0.902	2.248	0.958
3.90	2.126	0.832	2.171	0.878	2.221	0.930	2.277	0.988
3.95	2.150	0.857	2.196	0.904	2.248	0.958	2.306	1.017
4.00	2.174	0.882	2.222	0.931	2.275	0.985	2.335	1.047
4.05	2.199	0.907	2.248	0.957	2.302	1.013	2.363	1.077
4.10	2.223	0.932	2.273	0.983	2.329	1.041	2.392	1.106
4.15	2.247	0.957	2.299	1.010	2.356	1.069	2.421	1.136
4.20	2.271	0.982	2.324	1.036	2.383	1.097	2.450	1.166
4.25	2.296	1.007	2.350	1.063	2.410	1.125	2.478	1.195
4.30	2.320	1.032	2.375	1.089	2.437	1.153	2.507	1.225
4.35	2.344	1.057	2.401	1.115	2.464	1.181	2.536	1.255
4.40	2.368	1.082	2.426	1.142	2.491	1.209	2.565	1.284



$f_y$   
250  
 $f_{ck}$   
20

TABLE 46 FLEXURE — REINFORCEMENT PERCENTAGES FOR DOUBLY REINFORCED SECTIONS

$f_{ck} = 20 \text{ N/mm}^2$   
 $f_y = 250 \text{ N/mm}^2$

$M_u/(bd^2)$ $\text{N/mm}^2$	$d'/d = 0.05$		$d'/d = 0.10$		$d'/d = 0.15$		$d'/d = 0.20$	
	$P_L$	$P_o$	$P_L$	$P_o$	$P_L$	$P_o$	$P_L$	$P_o$
2.99	1.763	0.005	1.763	0.005	1.765	0.006	1.766	0.006
3.00	1.769	0.010	1.770	0.011	1.771	0.011	1.771	0.012
3.05	1.794	0.035	1.796	0.037	1.798	0.039	1.800	0.042
3.10	1.818	0.061	1.821	0.064	1.825	0.068	1.829	0.072
3.15	1.842	0.086	1.847	0.091	1.852	0.096	1.858	0.102
3.20	1.866	0.111	1.872	0.117	1.879	0.124	1.886	0.132
3.25	1.891	0.136	1.898	0.144	1.906	0.152	1.915	0.162
3.30	1.915	0.162	1.923	0.171	1.933	0.181	1.944	0.192
3.35	1.939	0.187	1.949	0.197	1.960	0.209	1.973	0.222
3.40	1.963	0.212	1.974	0.224	1.987	0.237	2.001	0.252
3.45	1.987	0.237	2.000	0.250	2.014	0.265	2.030	0.282
3.50	2.012	0.263	2.026	0.277	2.041	0.293	2.059	0.312
3.55	2.036	0.288	2.051	0.304	2.068	0.322	2.088	0.342
3.60	2.060	0.313	2.077	0.330	2.095	0.350	2.116	0.372
3.65	2.084	0.338	2.102	0.357	2.122	0.378	2.145	0.402
3.70	2.108	0.364	2.128	0.384	2.149	0.406	2.174	0.432
3.75	2.133	0.389	2.153	0.410	2.177	0.434	2.203	0.462
3.80	2.157	0.414	2.179	0.437	2.204	0.463	2.231	0.492
3.85	2.181	0.439	2.204	0.464	2.231	0.491	2.260	0.522
3.90	2.205	0.464	2.230	0.490	2.258	0.519	2.289	0.552
3.95	2.229	0.490	2.256	0.517	2.285	0.547	2.318	0.582
4.00	2.254	0.515	2.281	0.544	2.312	0.576	2.346	0.612
4.05	2.278	0.540	2.307	0.570	2.339	0.604	2.375	0.642
4.10	2.302	0.565	2.332	0.597	2.366	0.632	2.404	0.672
4.15	2.326	0.591	2.358	0.624	2.393	0.660	2.433	0.701
4.20	2.351	0.616	2.383	0.650	2.420	0.688	2.461	0.731
4.25	2.375	0.641	2.409	0.677	2.447	0.717	2.490	0.761
4.30	2.399	0.666	2.434	0.703	2.474	0.745	2.519	0.791
4.35	2.423	0.692	2.460	0.730	2.501	0.773	2.548	0.821
4.40	2.447	0.717	2.486	0.757	2.528	0.801	2.576	0.851
4.45	2.472	0.743	2.511	0.783	2.555	0.830	2.605	0.881
4.50	2.496	0.767	2.537	0.810	2.582	0.858	2.634	0.911
4.55	2.520	0.793	2.562	0.837	2.609	0.886	2.663	0.941
4.60	2.544	0.818	2.588	0.863	2.637	0.914	2.691	0.971
4.65	2.568	0.843	2.613	0.890	2.664	0.942	2.720	1.001
4.70	2.593	0.868	2.639	0.917	2.691	0.971	2.749	1.031
4.75	2.617	0.894	2.664	0.943	2.718	0.999	2.778	1.061
4.80	2.641	0.919	2.690	0.970	2.745	1.027	2.806	1.091
4.85	2.665	0.944	2.716	0.997	2.772	1.055	2.835	1.121
4.90	2.689	0.969	2.741	1.023	2.799	1.083	2.864	1.151
4.95	2.714	0.995	2.767	1.050	2.826	1.112	2.893	1.181
5.00	2.738	1.020	2.792	1.077	2.853	1.140	2.921	1.211
5.05	2.762	1.045	2.818	1.103	2.880	1.168	2.950	1.241
5.10	2.786	1.070	2.843	1.130	2.907	1.196	2.979	1.271
5.15	2.811	1.096	2.869	1.157	2.934	1.225	3.008	1.301

TABLE 47 FLEXURE—REINFORCEMENT PERCENTAGES FOR DOUBLY REINFORCED SECTIONS

$f_{ck} = 25 \text{ N/mm}^2$   
 $f_y = 250 \text{ N/mm}^2$

$M_u/5d^2$ , $\text{N/mm}^2$	$d'/d = 0.05$		$d'/d = 0.10$		$d'/d = 0.15$		$d'/d = 0.20$	
	$P_1$	$P_2$	$P_1$	$P_2$	$P_1$	$P_2$	$P_1$	$P_2$
3.73	2.202	0.002	2.202	0.003	2.202	0.003	2.203	0.003
3.75	2.212	0.013	2.213	0.013	2.213	0.014	2.214	0.015
3.80	2.236	0.038	2.238	0.040	2.240	0.043	2.243	0.045
3.85	2.260	0.064	2.264	0.067	2.267	0.071	2.272	0.076
3.90	2.284	0.089	2.289	0.094	2.294	0.100	2.300	0.106
3.95	2.309	0.115	2.315	0.121	2.322	0.128	2.329	0.136
4.00	2.333	0.140	2.340	0.148	2.349	0.157	2.358	0.167
4.05	2.357	0.166	2.366	0.175	2.376	0.185	2.387	0.197
4.10	2.381	0.191	2.391	0.202	2.403	0.214	2.415	0.227
4.15	2.406	0.217	2.417	0.229	2.430	0.242	2.444	0.258
4.20	2.430	0.243	2.443	0.256	2.457	0.271	2.473	0.288
4.25	2.454	0.268	2.468	0.283	2.484	0.299	2.502	0.318
4.30	2.478	0.293	2.494	0.310	2.511	0.328	2.530	0.348
4.35	2.502	0.319	2.519	0.337	2.538	0.356	2.559	0.379
4.40	2.527	0.344	2.545	0.364	2.565	0.385	2.588	0.409
4.45	2.551	0.370	2.570	0.391	2.592	0.414	2.617	0.439
4.50	2.575	0.395	2.596	0.417	2.619	0.442	2.645	0.470
4.55	2.599	0.421	2.621	0.444	2.646	0.471	2.674	0.500
4.60	2.623	0.447	2.647	0.471	2.673	0.499	2.703	0.530
4.65	2.648	0.472	2.673	0.498	2.700	0.528	2.732	0.561
4.70	2.672	0.498	2.698	0.525	2.727	0.556	2.760	0.591
4.75	2.696	0.523	2.724	0.552	2.754	0.585	2.789	0.621
4.80	2.720	0.549	2.749	0.579	2.782	0.613	2.818	0.651
4.85	2.744	0.574	2.775	0.606	2.809	0.642	2.847	0.682
4.90	2.769	0.600	2.800	0.633	2.836	0.670	2.875	0.712
4.95	2.793	0.625	2.826	0.660	2.863	0.699	2.904	0.742
5.00	2.817	0.651	2.851	0.687	2.890	0.727	2.933	0.773
5.05	2.841	0.676	2.877	0.714	2.917	0.756	2.962	0.803
5.10	2.865	0.702	2.903	0.741	2.944	0.784	2.990	0.833
5.15	2.890	0.727	2.928	0.768	2.971	0.813	3.019	0.864
5.20	2.914	0.753	2.954	0.795	3.008	0.841	3.048	0.894
5.25	2.938	0.778	2.979	0.822	3.035	0.870	3.077	0.924
5.30	2.962	0.804	3.005	0.848	3.062	0.898	3.105	0.955
5.35	2.987	0.829	3.030	0.875	3.079	0.927	3.134	0.985
5.40	3.011	0.855	3.056	0.902	3.106	0.955	3.163	1.015
5.45	3.035	0.880	3.081	0.929	3.133	0.984	3.192	1.045
5.50	3.059	0.906	3.107	0.956	3.160	1.012	3.220	1.076
5.55	3.083	0.931	3.133	0.983	3.187	1.041	3.249	1.106
5.60	3.108	0.957	3.158	1.010	3.214	1.070	3.278	1.136
5.65	3.132	0.982	3.184	1.037	3.242	1.098	3.307	1.167
5.70	3.156	1.008	3.209	1.064	3.269	1.127	3.335	1.197
5.75	3.180	1.033	3.235	1.091	3.296	1.155	3.364	1.227
5.80	3.204	1.059	3.260	1.118	3.323	1.184	3.393	1.258
5.85	3.229	1.085	3.286	1.145	3.350	1.212	3.422	1.288
5.90	3.253	1.110	3.311	1.172	3.377	1.241	3.450	1.318

$f_y$   
250  
 $f_{ck}$   
30

TABLE 48 FLEXURE—REINFORCEMENT PERCENTAGES FOR DOUBLY REINFORCED SECTIONS

$f_{ck} = 30 \text{ N/mm}^2$   
 $f_y = 250 \text{ N/mm}^2$

$M_u/bd^2$ , N/mm <sup>2</sup>	$d'/d = 0.05$		$d'/d = 0.10$		$d'/d = 0.15$		$d'/d = 0.20$	
	$P_t$	$P_c$	$P_t$	$P_c$	$P_t$	$P_c$	$P_t$	$P_c$
4.48	2.645	0.005	2.645	0.005	2.645	0.006	2.645	0.006
4.50	2.654	0.015	2.655	0.016	2.656	0.017	2.657	0.018
4.55	2.678	0.041	2.681	0.043	2.683	0.046	2.686	0.049
4.60	2.703	0.067	2.706	0.071	2.710	0.075	2.714	0.080
4.65	2.727	0.093	2.732	0.098	2.737	0.104	2.743	0.110
4.70	2.751	0.119	2.757	0.125	2.764	0.133	2.772	0.141
4.75	2.775	0.144	2.783	0.152	2.791	0.161	2.801	0.171
4.80	2.799	0.170	2.808	0.180	2.818	0.190	2.829	0.202
4.85	2.824	0.196	2.834	0.207	2.845	0.219	2.858	0.233
4.90	2.848	0.222	2.859	0.234	2.872	0.248	2.887	0.263
4.95	2.872	0.248	2.885	0.261	2.899	0.277	2.916	0.294
5.00	2.896	0.273	2.911	0.289	2.927	0.306	2.944	0.325
5.05	2.921	0.299	2.936	0.316	2.954	0.334	2.973	0.355
5.10	2.945	0.325	2.962	0.343	2.981	0.363	3.002	0.386
5.15	2.969	0.351	2.987	0.370	3.008	0.392	3.031	0.417
5.20	2.993	0.377	3.013	0.398	3.035	0.421	3.059	0.447
5.25	3.017	0.402	3.038	0.425	3.062	0.450	3.088	0.478
5.30	3.042	0.428	3.064	0.452	3.089	0.479	3.117	0.508
5.35	3.066	0.454	3.089	0.479	3.116	0.507	3.146	0.539
5.40	3.090	0.480	3.115	0.506	3.143	0.536	3.174	0.570
5.45	3.114	0.506	3.141	0.534	3.170	0.565	3.203	0.600
5.50	3.138	0.531	3.166	0.561	3.197	0.594	3.232	0.631
5.55	3.163	0.557	3.192	0.588	3.224	0.623	3.261	0.662
5.60	3.187	0.583	3.217	0.615	3.251	0.652	3.289	0.692
5.65	3.211	0.609	3.243	0.643	3.278	0.680	3.318	0.723
5.70	3.235	0.635	3.268	0.670	3.305	0.709	3.347	0.754
5.75	3.259	0.660	3.294	0.697	3.332	0.738	3.376	0.784
5.80	3.284	0.686	3.319	0.724	3.359	0.767	3.404	0.815
5.85	3.308	0.712	3.345	0.752	3.387	0.796	3.433	0.845
5.90	3.332	0.738	3.371	0.779	3.414	0.825	3.462	0.876
5.95	3.356	0.764	3.396	0.806	3.441	0.853	3.491	0.907
6.00	3.381	0.789	3.422	0.833	3.468	0.882	3.519	0.937
6.05	3.405	0.815	3.447	0.860	3.495	0.911	3.548	0.968
6.10	3.429	0.841	3.473	0.888	3.522	0.940	3.577	0.999
6.15	3.453	0.867	3.498	0.915	3.549	0.969	3.606	1.029
6.20	3.477	0.893	3.524	0.942	3.576	0.998	3.634	1.060
6.25	3.502	0.918	3.549	0.969	3.603	1.026	3.663	1.091
6.30	3.526	0.944	3.575	0.997	3.630	1.055	3.692	1.121
6.35	3.550	0.970	3.601	1.024	3.657	1.084	3.721	1.152
6.40	3.574	0.996	3.626	1.051	3.684	1.113	3.749	1.182
6.45	3.598	1.022	3.652	1.078	3.711	1.142	3.778	1.213
6.50	3.623	1.047	3.677	1.106	3.738	1.171	3.807	1.244
6.55	3.647	1.073	3.703	1.133	3.765	1.199	3.836	1.274
6.60	3.671	1.099	3.728	1.160	3.792	1.228	3.864	1.305
6.65	3.695	1.125	3.754	1.187	3.819	1.257	3.893	1.336

TABLE 49 FLEXURE — REINFORCEMENT PERCENTAGES FOR DOUBLY REINFORCED SECTIONS

$f_{ck} = 15 \text{ N/mm}^2$   
 $f_y = 415 \text{ N/mm}^2$

$M_u/Bd^2$ , $\text{N/mm}^2$	$d'/d = 0.05$		$d'/d = 0.10$		$d'/d = 0.15$		$d'/d = 0.20$	
	$P_t$	$P_c$	$P_t$	$P_c$	$P_t$	$P_c$	$P_t$	$P_c$
2.08	0.719	0.003	0.720	0.003	0.720	0.003	0.720	0.003
2.10	0.725	0.009	0.726	0.009	0.726	0.010	0.727	0.011
2.20	0.754	0.039	0.757	0.041	0.759	0.045	0.761	0.050
2.30	0.784	0.069	0.787	0.073	0.791	0.080	0.796	0.089
2.40	0.813	0.099	0.818	0.106	0.824	0.115	0.831	0.127
2.50	0.842	0.129	0.849	0.138	0.857	0.150	0.865	0.166
2.60	0.871	0.160	0.880	0.170	0.889	0.185	0.900	0.205
2.70	0.900	0.190	0.910	0.202	0.922	0.220	0.935	0.244
2.80	0.929	0.220	0.941	0.234	0.954	0.255	0.969	0.282
2.90	0.959	0.250	0.972	0.267	0.987	0.290	1.004	0.321
3.00	0.988	0.280	1.003	0.299	1.020	0.323	1.039	0.360
3.10	1.017	0.311	1.034	0.331	1.052	0.360	1.073	0.399
3.20	1.046	0.341	1.064	0.363	1.085	0.395	1.108	0.438
3.30	1.075	0.371	1.095	0.395	1.117	0.430	1.142	0.476
3.40	1.104	0.401	1.126	0.427	1.150	0.465	1.177	0.515
3.50	1.134	0.432	1.157	0.460	1.183	0.500	1.212	0.554
3.60	1.163	0.462	1.188	0.492	1.215	0.535	1.246	0.593
3.70	1.192	0.492	1.218	0.524	1.248	0.571	1.281	0.631
3.80	1.221	0.522	1.249	0.556	1.280	0.606	1.316	0.670
3.90	1.250	0.552	1.280	0.588	1.313	0.641	1.350	0.709
4.00	1.279	0.583	1.311	0.621	1.346	0.676	1.385	0.748
4.10	1.309	0.613	1.342	0.653	1.378	0.711	1.420	0.787
4.20	1.338	0.643	1.372	0.685	1.411	0.746	1.454	0.825
4.30	1.367	0.673	1.403	0.717	1.443	0.781	1.489	0.864
4.40	1.396	0.703	1.434	0.749	1.476	0.816	1.524	0.903
4.50	1.425	0.734	1.465	0.781	1.509	0.851	1.558	0.942
4.60	1.455	0.764	1.495	0.814	1.541	0.886	1.593	0.980
4.70	1.484	0.794	1.526	0.846	1.574	0.921	1.627	1.019
4.80	1.513	0.824	1.557	0.878	1.606	0.956	1.662	1.058
4.90	1.542	0.855	1.588	0.910	1.639	0.991	1.697	1.097
5.00	1.571	0.885	1.619	0.942	1.672	1.026	1.731	1.136
5.10	1.600	0.915	1.649	0.975	1.704	1.061	1.766	1.174
5.20	1.630	0.945	1.680	1.007	1.737	1.096	1.801	1.213
5.30	1.659	0.975	1.711	1.039	1.769	1.131	1.835	1.252
5.40	1.688	1.006	1.742	1.071	1.802	1.166	1.870	1.291
5.50	1.717	1.036	1.773	1.103	1.835	1.201	1.905	1.329
5.60	1.746	1.066	1.803	1.136	1.867	1.236	1.939	1.368
5.70	1.775	1.096	1.834	1.168	1.900	1.271	1.974	1.407
5.80	1.805	1.126	1.865	1.200	1.932	1.306	2.008	1.446
5.90	1.834	1.157	1.896	1.232	1.965	1.341	2.043	1.485
6.00	1.863	1.187	1.927	1.264	1.998	1.376	2.078	1.523
6.10	1.892	1.217	1.957	1.296	2.030	1.411	2.112	1.562
6.20	1.921	1.247	1.988	1.329	2.063	1.446	2.147	1.601
6.30	1.950	1.278	2.019	1.361	2.095	1.481	2.182	1.640
6.40	1.980	1.308	2.050	1.393	2.128	1.517	2.216	1.678



TABLE 50 FLEXURE—REINFORCEMENT PERCENTAGES FOR DOUBLY REINFORCED SECTIONS

$f_{ck} = 20 \text{ N/mm}^2$   
 $f_y = 415 \text{ N/mm}^2$

$M_u/d^2$ , N/mm <sup>2</sup>	$d'/d = 0.05$		$d'/d = 0.10$		$d'/d = 0.15$		$d'/d = 0.20$	
	$P_t$	$P_c$	$P_t$	$P_c$	$P_t$	$P_c$	$P_t$	$P_c$
2.77	0.958	0.002	0.958	0.002	0.959	0.003	0.959	0.003
2.80	0.967	0.011	0.968	0.012	0.968	0.013	0.969	0.015
2.90	0.996	0.042	0.998	0.045	1.001	0.049	1.004	0.054
3.00	1.025	0.072	1.029	0.077	1.034	0.084	1.038	0.093
3.10	1.055	0.103	1.060	0.109	1.066	0.119	1.073	0.132
3.20	1.084	0.133	1.091	0.142	1.099	0.154	1.108	0.171
3.30	1.113	0.164	1.122	0.174	1.131	0.190	1.142	0.210
3.40	1.142	0.194	1.152	0.207	1.164	0.225	1.177	0.249
3.50	1.171	0.224	1.183	0.239	1.197	0.260	1.212	0.288
3.60	1.200	0.255	1.214	0.271	1.229	0.295	1.246	0.327
3.70	1.230	0.285	1.245	0.304	1.262	0.331	1.281	0.366
3.80	1.259	0.316	1.276	0.336	1.294	0.366	1.315	0.405
3.90	1.288	0.346	1.306	0.369	1.327	0.401	1.350	0.444
4.00	1.317	0.376	1.337	0.401	1.360	0.437	1.385	0.483
4.10	1.346	0.407	1.368	0.433	1.392	0.472	1.419	0.522
4.20	1.375	0.437	1.399	0.466	1.425	0.507	1.454	0.561
4.30	1.405	0.468	1.429	0.498	1.457	0.542	1.489	0.600
4.40	1.434	0.498	1.460	0.530	1.490	0.578	1.523	0.640
4.50	1.463	0.528	1.491	0.563	1.523	0.613	1.558	0.679
4.60	1.492	0.559	1.522	0.595	1.555	0.648	1.593	0.718
4.70	1.521	0.589	1.553	0.628	1.588	0.683	1.627	0.757
4.80	1.550	0.620	1.583	0.660	1.620	0.719	1.662	0.796
4.90	1.580	0.650	1.614	0.692	1.653	0.754	1.696	0.835
5.00	1.609	0.680	1.645	0.725	1.686	0.789	1.731	0.874
5.10	1.638	0.711	1.676	0.757	1.718	0.825	1.766	0.913
5.20	1.667	0.741	1.707	0.790	1.751	0.860	1.800	0.952
5.30	1.696	0.772	1.737	0.822	1.783	0.895	1.835	0.991
5.40	1.725	0.802	1.768	0.854	1.816	0.930	1.870	1.030
5.50	1.755	0.832	1.799	0.887	1.849	0.966	1.904	1.069
5.60	1.784	0.863	1.830	0.919	1.881	1.001	1.939	1.108
5.70	1.813	0.893	1.861	0.952	1.914	1.036	1.974	1.147
5.80	1.842	0.924	1.891	0.984	1.946	1.071	2.008	1.186
5.90	1.871	0.954	1.922	1.016	1.979	1.107	2.043	1.225
6.00	1.900	0.985	1.953	1.049	2.012	1.142	2.078	1.264
6.10	1.930	1.015	1.984	1.081	2.044	1.177	2.112	1.303
6.20	1.959	1.045	2.014	1.114	2.077	1.213	2.147	1.342
6.30	1.988	1.076	2.045	1.146	2.109	1.248	2.181	1.381
6.40	2.017	1.106	2.076	1.178	2.142	1.283	2.216	1.421
6.50	2.046	1.137	2.107	1.211	2.175	1.318	2.251	1.460
6.60	2.075	1.167	2.138	1.243	2.207	1.354	2.285	1.499
6.70	2.105	1.197	2.168	1.276	2.240	1.389	2.320	1.538
6.80	2.134	1.228	2.199	1.308	2.272	1.424	2.355	1.577
6.90	2.163	1.258	2.230	1.340	2.305	1.459	2.389	1.616
7.00	2.192	1.289	2.261	1.373	2.338	1.495	2.424	1.655
7.10	2.221	1.319	2.292	1.405	2.370	1.530	2.459	1.694

TABLE 51 FLEXURE—REINFORCEMENT PERCENTAGES FOR DOUBLY REINFORCED SECTIONS

$f_{ck} = 25 \text{ N/mm}^2$   
 $f_y = 415 \text{ N/mm}^2$

$M_u/bd^2$ , $\text{N/mm}^2$	$d'/d = 0.05$		$d'/d = 0.10$		$d'/d = 0.15$		$d'/d = 0.20$	
	$P_t$	$P_c$	$P_t$	$P_c$	$P_t$	$P_c$	$P_t$	$P_c$
3.46	1.197	0.002	1.197	0.002	1.197	0.003	1.197	0.003
3.50	1.209	0.014	1.210	0.015	1.210	0.017	1.211	0.019
3.60	1.238	0.045	1.240	0.048	1.243	0.052	1.246	0.058
3.70	1.267	0.076	1.271	0.081	1.276	0.088	1.281	0.097
3.80	1.296	0.106	1.302	0.113	1.308	0.123	1.315	0.137
3.90	1.325	0.137	1.333	0.146	1.341	0.159	1.350	0.176
4.00	1.355	0.167	1.363	0.178	1.373	0.194	1.385	0.215
4.10	1.384	0.198	1.394	0.211	1.406	0.230	1.419	0.254
4.20	1.413	0.229	1.423	0.244	1.439	0.265	1.454	0.294
4.30	1.442	0.259	1.456	0.276	1.471	0.301	1.488	0.333
4.40	1.471	0.290	1.487	0.309	1.504	0.336	1.523	0.372
4.50	1.500	0.320	1.517	0.341	1.536	0.372	1.558	0.412
4.60	1.530	0.351	1.548	0.374	1.569	0.407	1.592	0.451
4.70	1.559	0.382	1.579	0.407	1.602	0.443	1.627	0.490
4.80	1.588	0.412	1.610	0.439	1.634	0.478	1.662	0.530
4.90	1.617	0.443	1.641	0.472	1.667	0.514	1.696	0.569
5.00	1.646	0.474	1.671	0.504	1.699	0.549	1.731	0.608
5.10	1.675	0.504	1.702	0.537	1.732	0.585	1.766	0.648
5.20	1.705	0.535	1.733	0.570	1.765	0.620	1.800	0.687
5.30	1.734	0.565	1.764	0.602	1.797	0.656	1.835	0.726
5.40	1.763	0.596	1.795	0.635	1.830	0.691	1.869	0.766
5.50	1.792	0.627	1.825	0.667	1.862	0.727	1.904	0.805
5.60	1.821	0.657	1.856	0.700	1.895	0.762	1.939	0.844
5.70	1.851	0.688	1.887	0.733	1.928	0.798	1.973	0.884
5.80	1.880	0.718	1.918	0.765	1.960	0.833	2.008	0.923
5.90	1.909	0.749	1.948	0.798	1.993	0.869	2.043	0.962
6.00	1.938	0.780	1.979	0.830	2.025	0.904	2.077	1.002
6.10	1.967	0.810	2.010	0.863	2.058	0.940	2.112	1.041
6.20	1.996	0.841	2.041	0.896	2.091	0.975	2.147	1.080
6.30	2.026	0.871	2.072	0.928	2.123	1.011	2.181	1.120
6.40	2.055	0.902	2.102	0.961	2.156	1.046	2.216	1.159
6.50	2.084	0.933	2.133	0.993	2.188	1.082	2.251	1.198
6.60	2.113	0.963	2.164	1.026	2.221	1.118	2.285	1.238
6.70	2.142	0.994	2.195	1.059	2.254	1.153	2.320	1.277
6.80	2.171	1.024	2.226	1.091	2.286	1.189	2.354	1.316
6.90	2.201	1.055	2.256	1.124	2.319	1.224	2.389	1.356
7.00	2.230	1.086	2.287	1.157	2.351	1.260	2.424	1.395
7.10	2.259	1.116	2.318	1.189	2.384	1.295	2.458	1.434
7.20	2.288	1.147	2.349	1.222	2.417	1.331	2.493	1.474
7.30	2.317	1.177	2.380	1.254	2.449	1.366	2.528	1.513
7.40	2.346	1.208	2.410	1.287	2.482	1.402	2.562	1.552
7.50	2.376	1.239	2.441	1.320	2.514	1.437	2.597	1.591
7.60	2.405	1.269	2.472	1.352	2.547	1.473	2.632	1.631
7.70	2.434	1.300	2.503	1.385	2.580	1.508	2.666	1.670
7.80	2.463	1.330	2.534	1.417	2.612	1.544	2.701	1.709



TABLE 52 FLEXURE—REINFORCEMENT PERCENTAGES FOR DOUBLY REINFORCED SECTIONS

 $f_{ck} = 30 \text{ N/mm}^2$   
 $f_y = 415 \text{ N/mm}^2$ 

$M_u/bd^2$ , $\text{N/mm}^2$	$d'/d = 0.05$		$d'/d = 0.10$		$d'/d = 0.15$		$d'/d = 0.20$	
	$P_t$	$P_c$	$P_t$	$P_c$	$P_t$	$P_c$	$P_t$	$P_c$
4.15	1.436	0.002	1.436	0.002	1.436	0.002	1.436	0.003
4.20	1.451	0.017	1.451	0.019	1.452	0.020	1.454	0.022
4.30	1.480	0.048	1.482	0.051	1.485	0.056	1.488	0.062
4.40	1.509	0.079	1.513	0.084	1.518	0.092	1.523	0.102
4.50	1.538	0.110	1.544	0.117	1.550	0.127	1.558	0.141
4.60	1.567	0.141	1.575	0.150	1.583	0.163	1.592	0.181
4.70	1.596	0.171	1.605	0.183	1.615	0.199	1.627	0.220
4.80	1.626	0.202	1.636	0.215	1.648	0.235	1.661	0.260
4.90	1.655	0.233	1.667	0.248	1.681	0.270	1.696	0.300
5.00	1.684	0.264	1.698	0.281	1.713	0.306	1.731	0.339
5.10	1.713	0.295	1.729	0.314	1.746	0.342	1.765	0.379
5.20	1.742	0.325	1.759	0.347	1.778	0.378	1.800	0.418
5.30	1.771	0.356	1.790	0.380	1.811	0.413	1.835	0.458
5.40	1.801	0.387	1.821	0.412	1.844	0.449	1.869	0.498
5.50	1.830	0.418	1.852	0.445	1.876	0.485	1.904	0.537
5.60	1.859	0.449	1.883	0.478	1.909	0.521	1.939	0.577
5.70	1.888	0.479	1.913	0.511	1.941	0.556	1.973	0.616
5.80	1.917	0.510	1.944	0.544	1.974	0.592	2.008	0.656
5.90	1.946	0.541	1.975	0.576	2.007	0.628	2.042	0.696
6.00	1.976	0.572	2.006	0.609	2.039	0.664	2.077	0.735
6.10	2.005	0.603	2.036	0.642	2.072	0.699	2.112	0.775
6.20	2.034	0.634	2.067	0.675	2.104	0.735	2.146	0.814
6.30	2.063	0.664	2.098	0.708	2.137	0.771	2.181	0.854
6.40	2.092	0.695	2.129	0.741	2.170	0.807	2.216	0.894
6.50	2.121	0.726	2.160	0.773	2.202	0.842	2.250	0.933
6.60	2.151	0.757	2.190	0.806	2.235	0.878	2.285	0.973
6.70	2.180	0.788	2.221	0.839	2.267	0.914	2.320	1.012
6.80	2.209	0.818	2.252	0.872	2.300	0.950	2.354	1.052
6.90	2.238	0.849	2.283	0.905	2.333	0.985	2.389	1.092
7.00	2.267	0.880	2.314	0.937	2.365	1.021	2.424	1.131
7.10	2.296	0.911	2.344	0.970	2.398	1.057	2.458	1.171
7.20	2.326	0.942	2.375	1.003	2.431	1.093	2.493	1.210
7.30	2.355	0.972	2.406	1.036	2.463	1.128	2.527	1.250
7.40	2.384	1.003	2.437	1.069	2.496	1.164	2.562	1.290
7.50	2.413	1.034	2.468	1.102	2.528	1.200	2.597	1.329
7.60	2.442	1.065	2.498	1.134	2.561	1.236	2.631	1.369
7.70	2.471	1.096	2.529	1.167	2.594	1.271	2.666	1.408
7.80	2.501	1.126	2.560	1.200	2.626	1.307	2.701	1.448
7.90	2.530	1.157	2.591	1.233	2.659	1.343	2.735	1.488
8.00	2.559	1.188	2.621	1.266	2.691	1.379	2.770	1.527
8.10	2.588	1.219	2.652	1.299	2.724	1.414	2.805	1.567
8.20	2.617	1.250	2.683	1.331	2.757	1.450	2.839	1.606
8.30	2.646	1.280	2.714	1.364	2.789	1.486	2.874	1.646
8.40	2.676	1.311	2.745	1.397	2.822	1.522	2.908	1.686
8.50	2.705	1.342	2.775	1.430	2.854	1.557	2.943	1.725

TABLE 53 FLEXURE—REINFORCEMENT PERCENTAGES FOR DOUBLY REINFORCED SECTIONS

$f_{ck} = 15 \text{ N/mm}^2$   
 $f_y = 500 \text{ N/mm}^2$

$M_u/bd^2$ , N/mm <sup>2</sup>	$d'/d = 0.05$		$d'/d = 0.10$		$d'/d = 0.15$		$d'/d = 0.20$	
	$P_t$	$P_c$	$P_t$	$P_c$	$P_t$	$P_c$	$P_t$	$P_c$
2.00	0.568	0.001	0.568	0.001	0.568	0.001	0.568	0.002
2.10	0.592	0.026	0.593	0.029	0.595	0.032	0.596	0.036
2.20	0.616	0.052	0.619	0.056	0.622	0.062	0.625	0.070
2.30	0.640	0.077	0.644	0.084	0.649	0.092	0.654	0.105
2.40	0.664	0.102	0.670	0.111	0.676	0.122	0.683	0.139
2.50	0.689	0.127	0.695	0.138	0.703	0.153	0.711	0.173
2.60	0.713	0.153	0.721	0.166	0.730	0.183	0.740	0.208
2.70	0.737	0.178	0.746	0.193	0.757	0.213	0.769	0.242
2.80	0.761	0.203	0.772	0.221	0.784	0.244	0.798	0.276
2.90	0.785	0.228	0.798	0.248	0.811	0.274	0.826	0.310
3.00	0.810	0.253	0.823	0.276	0.838	0.304	0.855	0.345
3.10	0.834	0.279	0.849	0.303	0.865	0.334	0.884	0.379
3.20	0.858	0.304	0.874	0.330	0.892	0.365	0.913	0.413
3.30	0.882	0.329	0.900	0.358	0.919	0.395	0.941	0.448
3.40	0.906	0.354	0.925	0.385	0.946	0.425	0.970	0.482
3.50	0.931	0.380	0.951	0.413	0.974	0.455	0.999	0.516
3.60	0.955	0.405	0.976	0.440	1.001	0.486	1.028	0.551
3.70	0.979	0.430	1.002	0.468	1.028	0.516	1.056	0.585
3.80	1.003	0.455	1.028	0.495	1.055	0.546	1.085	0.619
3.90	1.028	0.481	1.053	0.523	1.082	0.577	1.114	0.654
4.00	1.052	0.506	1.079	0.550	1.109	0.607	1.143	0.688
4.10	1.076	0.531	1.104	0.577	1.136	0.637	1.171	0.722
4.20	1.100	0.556	1.130	0.605	1.163	0.667	1.200	0.757
4.30	1.124	0.582	1.155	0.632	1.190	0.698	1.229	0.791
4.40	1.149	0.607	1.181	0.660	1.217	0.728	1.258	0.825
4.50	1.173	0.632	1.206	0.687	1.244	0.758	1.286	0.860
4.60	1.197	0.657	1.232	0.715	1.271	0.789	1.315	0.894
4.70	1.221	0.682	1.258	0.742	1.298	0.819	1.344	0.928
4.80	1.245	0.708	1.283	0.769	1.325	0.849	1.373	0.963
4.90	1.270	0.733	1.309	0.797	1.352	0.879	1.401	0.997
5.00	1.294	0.758	1.334	0.824	1.379	0.910	1.430	1.031
5.10	1.318	0.783	1.360	0.852	1.406	0.940	1.459	1.066
5.20	1.342	0.809	1.385	0.879	1.434	0.970	1.488	1.100
5.30	1.366	0.834	1.411	0.907	1.461	1.000	1.516	1.134
5.40	1.391	0.859	1.436	0.934	1.488	1.031	1.545	1.169
5.50	1.415	0.884	1.462	0.962	1.515	1.061	1.574	1.203
5.60	1.439	0.910	1.488	0.989	1.542	1.091	1.603	1.237
5.70	1.463	0.935	1.513	1.016	1.569	1.122	1.631	1.272
5.80	1.488	0.960	1.539	1.044	1.596	1.152	1.660	1.306
5.90	1.512	0.985	1.564	1.071	1.623	1.182	1.689	1.340
6.00	1.536	1.011	1.590	1.099	1.650	1.212	1.718	1.375
6.10	1.560	1.036	1.615	1.126	1.677	1.243	1.746	1.409
6.20	1.584	1.061	1.641	1.154	1.704	1.273	1.775	1.443
6.30	1.609	1.086	1.666	1.181	1.731	1.303	1.804	1.478
6.40	1.633	1.111	1.692	1.208	1.758	1.334	1.833	1.512



$f_y$   
500  
 $f_{ck}$   
20

TABLE 54 FLEXURE—REINFORCEMENT PERCENTAGES FOR DOUBLY REINFORCED SECTIONS

$f_{ck} = 20 \text{ N/mm}^2$   
 $f_y = 500 \text{ N/mm}^2$

$M_u/bd^2$ , $\text{N/mm}^2$	$d'/d = 0.05$		$d'/d = 0.10$		$d'/d = 0.15$		$d'/d = 0.20$	
	$P_t$	$P_o$	$P_t$	$P_o$	$P_t$	$P_o$	$P_t$	$P_o$
2.67	0.758	0.002	0.758	0.003	0.758	0.003	0.758	0.003
2.70	0.765	0.010	0.765	0.011	0.766	0.012	0.767	0.014
2.80	0.789	0.035	0.791	0.038	0.793	0.042	0.795	0.048
2.90	0.813	0.061	0.816	0.066	0.820	0.073	0.824	0.083
3.00	0.837	0.086	0.842	0.094	0.847	0.103	0.853	0.117
3.10	0.862	0.111	0.868	0.121	0.874	0.134	0.882	0.152
3.20	0.886	0.137	0.893	0.149	0.901	0.164	0.910	0.186
3.30	0.910	0.162	0.919	0.176	0.928	0.195	0.939	0.221
3.40	0.934	0.188	0.944	0.204	0.955	0.225	0.968	0.255
3.50	0.958	0.213	0.970	0.232	0.982	0.256	0.997	0.290
3.60	0.983	0.238	0.995	0.259	1.000	0.286	1.025	0.324
3.70	1.007	0.264	1.021	0.287	1.036	0.316	1.054	0.359
3.80	1.031	0.289	1.046	0.314	1.064	0.347	1.083	0.394
3.90	1.055	0.314	1.072	0.342	1.091	0.377	1.112	0.428
4.00	1.080	0.340	1.098	0.369	1.118	0.408	1.140	0.463
4.10	1.104	0.365	1.123	0.397	1.145	0.438	1.169	0.497
4.20	1.128	0.391	1.149	0.425	1.172	0.469	1.198	0.532
4.30	1.152	0.416	1.174	0.452	1.199	0.499	1.227	0.566
4.40	1.176	0.441	1.200	0.480	1.226	0.530	1.255	0.601
4.50	1.201	0.467	1.225	0.507	1.253	0.560	1.284	0.635
4.60	1.225	0.492	1.251	0.535	1.280	0.591	1.313	0.670
4.70	1.249	0.517	1.276	0.563	1.307	0.621	1.342	0.704
4.80	1.273	0.543	1.302	0.590	1.334	0.651	1.370	0.739
4.90	1.297	0.568	1.328	0.618	1.361	0.682	1.399	0.773
5.00	1.322	0.593	1.353	0.645	1.388	0.712	1.428	0.808
5.10	1.346	0.619	1.379	0.673	1.415	0.743	1.457	0.843
5.20	1.370	0.644	1.404	0.701	1.442	0.773	1.485	0.877
5.30	1.394	0.670	1.430	0.728	1.469	0.804	1.514	0.912
5.40	1.418	0.695	1.455	0.756	1.496	0.834	1.543	0.946
5.50	1.443	0.720	1.481	0.783	1.524	0.865	1.572	0.981
5.60	1.467	0.746	1.506	0.811	1.551	0.895	1.600	1.015
5.70	1.491	0.771	1.532	0.839	1.578	0.925	1.629	1.050
5.80	1.515	0.796	1.558	0.866	1.605	0.956	1.658	1.084
5.90	1.540	0.822	1.583	0.894	1.632	0.986	1.687	1.119
6.00	1.564	0.847	1.609	0.921	1.659	1.017	1.715	1.153
6.10	1.588	0.873	1.634	0.949	1.686	1.047	1.744	1.188
6.20	1.612	0.898	1.660	0.976	1.713	1.078	1.773	1.223
6.30	1.636	0.923	1.685	1.004	1.740	1.108	1.802	1.257
6.40	1.661	0.949	1.711	1.032	1.767	1.139	1.830	1.292
6.50	1.685	0.974	1.736	1.059	1.794	1.169	1.859	1.326
6.60	1.709	0.999	1.762	1.087	1.821	1.200	1.888	1.361
6.70	1.733	1.025	1.788	1.114	1.848	1.230	1.917	1.395
6.80	1.757	1.050	1.813	1.142	1.875	1.260	1.945	1.430
6.90	1.782	1.076	1.839	1.170	1.902	1.291	1.974	1.464
7.00	1.806	1.101	1.864	1.197	1.929	1.321	2.003	1.499

TABLE 55 FLEXURE—REINFORCEMENT PERCENTAGES FOR DOUBLY REINFORCED SECTIONS

$f_{ck} = 25 \text{ N/mm}^2$   
 $f_y = 500 \text{ N/mm}^2$

$M_u/10d^2$ , $\text{N/mm}^2$	$d'/d = 0.05$		$d'/d = 0.10$		$d'/d = 0.15$		$d'/d = 0.20$	
	$P_t$	$P_c$	$P_t$	$P_c$	$P_t$	$P_c$	$P_t$	$P_c$
3.33	0.945	0.001	0.945	0.001	0.945	0.001	0.945	0.001
3.40	0.962	0.019	0.963	0.021	0.964	0.023	0.965	0.026
3.50	0.986	0.044	0.989	0.048	0.991	0.053	0.994	0.060
3.60	1.010	0.070	1.014	0.076	1.018	0.084	1.023	0.095
3.70	1.035	0.095	1.040	0.104	1.045	0.115	1.052	0.130
3.80	1.059	0.121	1.065	0.132	1.072	0.145	1.080	0.165
3.90	1.083	0.146	1.091	0.159	1.099	0.176	1.109	0.200
4.00	1.107	0.172	1.116	0.187	1.126	0.206	1.138	0.234
4.10	1.131	0.197	1.142	0.215	1.154	0.237	1.167	0.269
4.20	1.156	0.223	1.167	0.242	1.181	0.268	1.195	0.304
4.30	1.180	0.248	1.193	0.270	1.208	0.298	1.224	0.339
4.40	1.204	0.274	1.219	0.298	1.235	0.329	1.253	0.373
4.50	1.228	0.299	1.244	0.326	1.262	0.360	1.282	0.408
4.60	1.253	0.325	1.270	0.353	1.289	0.390	1.310	0.443
4.70	1.277	0.350	1.295	0.381	1.316	0.421	1.339	0.478
4.80	1.301	0.376	1.321	0.409	1.343	0.451	1.368	0.512
4.90	1.325	0.402	1.346	0.437	1.370	0.482	1.397	0.547
5.00	1.349	0.427	1.372	0.464	1.397	0.513	1.425	0.582
5.10	1.374	0.453	1.397	0.492	1.424	0.543	1.454	0.617
5.20	1.398	0.478	1.423	0.520	1.451	0.574	1.483	0.651
5.30	1.422	0.504	1.449	0.548	1.478	0.605	1.512	0.686
5.40	1.446	0.529	1.474	0.575	1.505	0.635	1.540	0.721
5.50	1.470	0.555	1.500	0.603	1.532	0.666	1.569	0.756
5.60	1.495	0.580	1.525	0.631	1.559	0.697	1.598	0.790
5.70	1.519	0.606	1.551	0.659	1.586	0.727	1.627	0.825
5.80	1.543	0.631	1.576	0.686	1.614	0.758	1.655	0.860
5.90	1.567	0.657	1.602	0.714	1.641	0.788	1.684	0.895
6.00	1.592	0.682	1.627	0.742	1.668	0.819	1.713	0.929
6.10	1.616	0.708	1.653	0.770	1.695	0.850	1.742	0.964
6.20	1.640	0.733	1.679	0.797	1.722	0.880	1.770	0.999
6.30	1.664	0.759	1.704	0.825	1.749	0.911	1.799	1.034
6.40	1.688	0.784	1.730	0.853	1.776	0.942	1.828	1.068
6.50	1.713	0.810	1.755	0.881	1.803	0.972	1.857	1.103
6.60	1.737	0.835	1.781	0.908	1.830	1.003	1.885	1.138
6.70	1.761	0.861	1.806	0.936	1.857	1.033	1.914	1.173
6.80	1.785	0.886	1.832	0.964	1.884	1.064	1.943	1.207
6.90	1.809	0.912	1.857	0.992	1.911	1.095	1.972	1.242
7.00	1.834	0.937	1.883	1.019	1.938	1.125	2.000	1.277
7.10	1.858	0.963	1.909	1.047	1.965	1.156	2.029	1.312
7.20	1.882	0.988	1.934	1.075	1.992	1.187	2.058	1.346
7.30	1.906	1.014	1.960	1.103	2.019	1.217	2.087	1.381
7.40	1.930	1.039	1.985	1.130	2.046	1.248	2.115	1.416
7.50	1.955	1.065	2.011	1.158	2.074	1.278	2.144	1.451
7.60	1.979	1.090	2.036	1.186	2.101	1.309	2.173	1.486
7.70	2.003	1.116	2.062	1.213	2.128	1.340	2.202	1.520



$f_y$   
500  
 $f_{ck}$   
30

TABLE 56 FLEXURE—REINFORCEMENT PERCENTAGES FOR DOUBLY REINFORCED SECTIONS

$f_{ck} = 30 \text{ N/mm}^2$   
 $f_y = 500 \text{ N/mm}^2$

$M_u/bd^2$ , $\text{N/mm}^2$	$d'/d = 0.05$		$d'/d = 0.10$		$d'/d = 0.15$		$d'/d = 0.20$	
	$P_t$	$P_c$	$P_t$	$P_c$	$P_t$	$P_c$	$P_t$	$P_c$
4.00	1.135	0.002	1.135	0.002	1.135	0.003	1.135	0.003
4.10	1.159	0.028	1.161	0.030	1.162	0.034	1.164	0.038
4.20	1.183	0.054	1.186	0.058	1.189	0.064	1.193	0.073
4.30	1.208	0.079	1.212	0.086	1.216	0.095	1.222	0.108
4.40	1.232	0.105	1.237	0.114	1.244	0.126	1.250	0.143
4.50	1.256	0.130	1.263	0.142	1.271	0.157	1.279	0.178
4.60	1.280	0.156	1.289	0.170	1.298	0.188	1.308	0.213
4.70	1.305	0.182	1.314	0.198	1.325	0.218	1.337	0.248
4.80	1.329	0.207	1.340	0.226	1.352	0.249	1.365	0.283
4.90	1.353	0.233	1.365	0.254	1.379	0.280	1.394	0.318
5.00	1.377	0.259	1.391	0.281	1.406	0.311	1.423	0.353
5.10	1.401	0.284	1.416	0.309	1.433	0.342	1.452	0.388
5.20	1.426	0.310	1.442	0.337	1.460	0.372	1.480	0.423
5.30	1.450	0.336	1.467	0.365	1.487	0.403	1.509	0.458
5.40	1.474	0.361	1.493	0.393	1.514	0.434	1.538	0.493
5.50	1.498	0.387	1.519	0.421	1.541	0.465	1.567	0.528
5.60	1.522	0.413	1.544	0.449	1.568	0.496	1.595	0.563
5.70	1.547	0.438	1.570	0.477	1.595	0.526	1.624	0.598
5.80	1.571	0.464	1.595	0.505	1.622	0.557	1.653	0.633
5.90	1.595	0.490	1.621	0.533	1.649	0.588	1.682	0.668
6.00	1.619	0.515	1.646	0.560	1.676	0.619	1.710	0.703
6.10	1.643	0.541	1.672	0.588	1.704	0.650	1.739	0.738
6.20	1.668	0.566	1.697	0.616	1.731	0.680	1.768	0.773
6.30	1.692	0.592	1.723	0.644	1.758	0.711	1.797	0.807
6.40	1.716	0.618	1.749	0.672	1.785	0.742	1.825	0.842
6.50	1.740	0.643	1.774	0.700	1.812	0.773	1.854	0.877
6.60	1.765	0.669	1.800	0.728	1.839	0.804	1.883	0.912
6.70	1.789	0.695	1.825	0.756	1.866	0.835	1.912	0.947
6.80	1.813	0.720	1.851	0.784	1.893	0.865	1.940	0.982
6.90	1.837	0.746	1.876	0.812	1.920	0.896	1.969	1.017
7.00	1.861	0.772	1.902	0.839	1.947	0.927	1.998	1.052
7.10	1.886	0.797	1.927	0.867	1.974	0.958	2.027	1.087
7.20	1.910	0.823	1.953	0.895	2.001	0.989	2.055	1.122
7.30	1.934	0.849	1.979	0.923	2.028	1.019	2.084	1.157
7.40	1.958	0.874	2.004	0.951	2.055	1.050	2.113	1.192
7.50	1.982	0.900	2.030	0.979	2.082	1.081	2.142	1.227
7.60	2.007	0.926	2.055	1.007	2.109	1.112	2.170	1.262
7.70	2.031	0.951	2.081	1.035	2.136	1.143	2.199	1.297
7.80	2.055	0.977	2.106	1.063	2.164	1.173	2.228	1.332
7.90	2.079	1.002	2.132	1.091	2.191	1.204	2.257	1.367
8.00	2.103	1.028	2.157	1.118	2.218	1.235	2.285	1.402
8.10	2.128	1.054	2.183	1.146	2.245	1.266	2.314	1.437
8.20	2.152	1.079	2.209	1.174	2.272	1.297	2.343	1.472
8.30	2.176	1.105	2.234	1.202	2.299	1.327	2.372	1.507

TABLE 57 FLEXURE—LIMITING MOMENT OF RESISTANCE FACTOR,  $M_{u,lim}/b_w d^2 f_{ck}$ , FOR SINGLY REINFORCED T-BEAMS,  $N/mm^2$

$f_y = 250 N/mm^2$

$D/d$	$b_f/b_w$									
	1.0	2.0	3.0	4.0	5.0	6.0	7.0	8.0	9.0	10.0
0.06	0.149	0.175	0.201	0.227	0.253	0.279	0.303	0.331	0.357	0.383
0.07	0.149	0.179	0.209	0.239	0.270	0.300	0.330	0.360	0.390	0.420
0.08	0.149	0.183	0.218	0.252	0.286	0.320	0.355	0.389	0.423	0.457
0.09	0.149	0.187	0.226	0.264	0.302	0.341	0.379	0.417	0.456	0.494
0.10	0.149	0.191	0.234	0.276	0.318	0.361	0.403	0.446	0.488	0.530
0.11	0.149	0.195	0.242	0.288	0.334	0.381	0.427	0.474	0.520	0.566
0.12	0.149	0.199	0.250	0.300	0.350	0.401	0.451	0.501	0.551	0.602
0.13	0.149	0.203	0.257	0.312	0.366	0.420	0.474	0.528	0.583	0.637
0.14	0.149	0.207	0.265	0.323	0.381	0.439	0.497	0.555	0.614	0.672
0.15	0.149	0.211	0.273	0.335	0.397	0.458	0.520	0.582	0.644	0.706
0.16	0.149	0.215	0.280	0.346	0.412	0.477	0.543	0.609	0.674	0.740
0.17	0.149	0.218	0.288	0.357	0.427	0.496	0.565	0.635	0.704	0.773
0.18	0.149	0.222	0.295	0.368	0.441	0.514	0.587	0.660	0.733	0.806
0.19	0.149	0.226	0.302	0.379	0.456	0.532	0.609	0.686	0.763	0.839
0.20	0.149	0.229	0.310	0.390	0.470	0.550	0.631	0.711	0.791	0.872
0.21	0.149	0.233	0.317	0.400	0.484	0.568	0.652	0.736	0.820	0.903
0.22	0.149	0.236	0.324	0.411	0.498	0.586	0.673	0.760	0.848	0.935
0.23	0.149	0.240	0.330	0.421	0.511	0.602	0.692	0.783	0.873	0.964
0.24	0.149	0.242	0.334	0.427	0.520	0.613	0.705	0.798	0.891	0.984
0.25	0.149	0.244	0.339	0.434	0.529	0.624	0.719	0.814	0.909	1.003
0.26	0.149	0.246	0.343	0.440	0.538	0.635	0.732	0.829	0.926	1.023
0.27	0.149	0.248	0.348	0.447	0.546	0.645	0.745	0.844	0.943	1.043
0.28	0.149	0.250	0.352	0.453	0.555	0.656	0.758	0.859	0.961	1.062
0.29	0.149	0.253	0.356	0.460	0.563	0.667	0.770	0.874	0.978	1.081
0.30	0.149	0.255	0.360	0.466	0.572	0.677	0.783	0.889	0.995	1.100
0.31	0.149	0.257	0.363	0.472	0.580	0.688	0.796	0.903	1.011	1.119
0.32	0.149	0.259	0.369	0.479	0.588	0.698	0.808	0.918	1.028	1.138
0.33	0.149	0.261	0.373	0.485	0.597	0.709	0.820	0.932	1.044	1.156
0.34	0.149	0.263	0.377	0.491	0.605	0.719	0.833	0.947	1.061	1.175
0.35	0.149	0.265	0.381	0.497	0.613	0.729	0.845	0.961	1.077	1.193
0.36	0.149	0.267	0.385	0.503	0.621	0.739	0.857	0.975	1.093	1.211
0.37	0.149	0.269	0.389	0.509	0.629	0.749	0.869	0.989	1.109	1.229
0.38	0.149	0.271	0.393	0.515	0.637	0.759	0.880	1.002	1.124	1.246
0.39	0.149	0.273	0.397	0.521	0.644	0.768	0.892	1.016	1.140	1.264
0.40	0.149	0.275	0.401	0.526	0.652	0.778	0.904	1.029	1.155	1.281
0.41	0.149	0.277	0.404	0.532	0.660	0.787	0.915	1.043	1.170	1.298
0.42	0.149	0.279	0.408	0.538	0.667	0.797	0.926	1.056	1.186	1.315
0.43	0.149	0.280	0.412	0.543	0.675	0.806	0.938	1.069	1.200	1.332
0.44	0.149	0.282	0.416	0.549	0.682	0.815	0.949	1.082	1.215	1.349
0.45	0.149	0.284	0.419	0.554	0.689	0.825	0.960	1.095	1.230	1.365

TABLE 58. FLEXURE — LIMITING MOMENT OF RESISTANCE FACTOR,  $M_{u,lim}/b_w d^2 f_{ck}$ , FOR SINGLY REINFORCED T-BEAMS,  $N/mm^2$

$f_y = 415 N/mm^2$

$D/d$	$b_f/b_w$									
	1.0	2.0	3.0	4.0	5.0	6.0	7.0	8.0	9.0	10.0
0.06	0.138	0.164	0.190	0.216	0.242	0.268	0.294	0.320	0.346	0.372
0.07	0.138	0.168	0.198	0.228	0.259	0.289	0.319	0.349	0.379	0.409
0.08	0.138	0.172	0.207	0.241	0.275	0.309	0.344	0.378	0.412	0.446
0.09	0.138	0.176	0.215	0.253	0.291	0.330	0.368	0.406	0.445	0.483
0.10	0.138	0.180	0.223	0.265	0.308	0.350	0.392	0.435	0.477	0.519
0.11	0.138	0.184	0.231	0.277	0.324	0.370	0.416	0.463	0.509	0.555
0.12	0.138	0.188	0.239	0.289	0.339	0.390	0.440	0.490	0.541	0.591
0.13	0.138	0.192	0.247	0.301	0.355	0.409	0.463	0.518	0.572	0.626
0.14	0.138	0.196	0.254	0.312	0.370	0.428	0.487	0.545	0.603	0.661
0.15	0.138	0.200	0.262	0.324	0.386	0.448	0.509	0.571	0.633	0.695
0.16	0.138	0.204	0.269	0.335	0.401	0.466	0.532	0.598	0.663	0.729
0.17	0.138	0.207	0.277	0.346	0.416	0.485	0.554	0.624	0.693	0.762
0.18	0.138	0.211	0.284	0.357	0.430	0.503	0.576	0.649	0.723	0.796
0.19	0.138	0.215	0.291	0.368	0.445	0.522	0.598	0.675	0.752	0.828
0.20	0.138	0.218	0.299	0.379	0.459	0.540	0.620	0.700	0.780	0.861
0.21	0.138	0.221	0.305	0.388	0.471	0.554	0.638	0.721	0.804	0.887
0.22	0.138	0.224	0.309	0.395	0.480	0.566	0.651	0.737	0.822	0.908
0.23	0.138	0.226	0.314	0.402	0.489	0.577	0.665	0.753	0.841	0.928
0.24	0.138	0.228	0.318	0.408	0.498	0.588	0.678	0.768	0.859	0.949
0.25	0.138	0.230	0.323	0.415	0.507	0.600	0.692	0.784	0.876	0.969
0.26	0.138	0.233	0.327	0.422	0.516	0.611	0.705	0.800	0.894	0.989
0.27	0.138	0.235	0.331	0.428	0.525	0.622	0.718	0.815	0.912	1.008
0.28	0.138	0.237	0.336	0.435	0.534	0.632	0.731	0.830	0.929	1.028
0.29	0.138	0.239	0.340	0.441	0.542	0.643	0.744	0.845	0.946	1.047
0.30	0.138	0.241	0.344	0.448	0.551	0.654	0.757	0.860	0.963	1.066
0.31	0.138	0.243	0.349	0.454	0.559	0.664	0.770	0.875	0.980	1.085
0.32	0.138	0.245	0.353	0.460	0.568	0.675	0.782	0.890	0.997	1.104
0.33	0.138	0.248	0.357	0.466	0.576	0.685	0.795	0.904	1.014	1.123
0.34	0.138	0.250	0.361	0.473	0.584	0.696	0.807	0.919	1.030	1.142
0.35	0.138	0.252	0.365	0.479	0.592	0.706	0.819	0.933	1.046	1.160
0.36	0.138	0.254	0.369	0.485	0.600	0.716	0.831	0.947	1.063	1.178
0.37	0.138	0.256	0.373	0.491	0.608	0.726	0.843	0.961	1.079	1.196
0.38	0.138	0.258	0.377	0.497	0.616	0.736	0.855	0.975	1.094	1.214
0.39	0.138	0.260	0.381	0.503	0.624	0.746	0.867	0.989	1.110	1.232
0.40	0.138	0.262	0.385	0.508	0.632	0.755	0.879	1.002	1.126	1.249
0.41	0.138	0.263	0.389	0.514	0.640	0.765	0.890	1.016	1.141	1.267
0.42	0.138	0.265	0.393	0.520	0.647	0.775	0.902	1.029	1.156	1.284
0.43	0.138	0.267	0.396	0.526	0.655	0.784	0.913	1.042	1.172	1.301
0.44	0.138	0.269	0.400	0.531	0.662	0.793	0.924	1.055	1.187	1.318
0.45	0.138	0.271	0.404	0.537	0.670	0.803	0.936	1.068	1.201	1.334



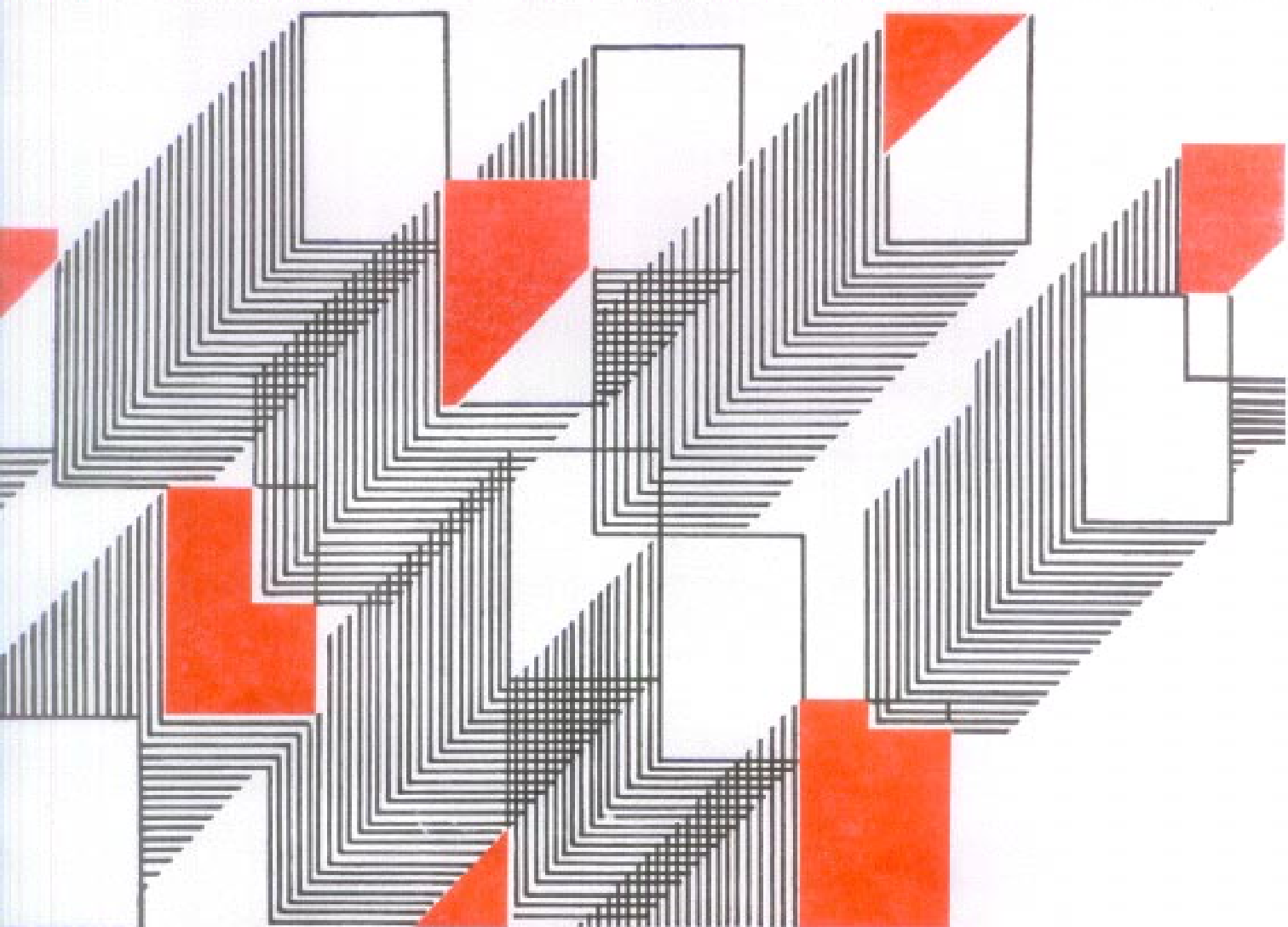
TABLE 59 FLEXURE—LIMITING MOMENT OF RESISTANCE FACTOR,  $M_{a,lim}/b_w d^2 f_{sk}$ , FOR SINGLY REINFORCED T-BEAMS,  $N/mm^2$

$f_y = 500 N/mm^2$

$D_e/d$	$b_f/b_w$									
	1.0	2.0	3.0	4.0	5.0	6.0	7.0	8.0	9.0	10.0
0.06	0.133	0.159	0.185	0.211	0.237	0.263	0.289	0.315	0.341	0.367
0.07	0.133	0.163	0.193	0.223	0.254	0.284	0.314	0.344	0.374	0.404
0.08	0.133	0.167	0.202	0.236	0.270	0.304	0.339	0.373	0.407	0.441
0.09	0.133	0.171	0.210	0.248	0.286	0.325	0.363	0.401	0.440	0.478
0.10	0.133	0.175	0.218	0.260	0.303	0.345	0.387	0.430	0.472	0.514
0.11	0.133	0.179	0.226	0.272	0.318	0.365	0.411	0.458	0.504	0.550
0.12	0.133	0.183	0.234	0.284	0.334	0.385	0.435	0.485	0.536	0.586
0.13	0.133	0.187	0.241	0.296	0.350	0.404	0.458	0.513	0.567	0.621
0.14	0.133	0.191	0.249	0.307	0.365	0.423	0.481	0.540	0.598	0.656
0.15	0.133	0.195	0.257	0.319	0.381	0.442	0.504	0.566	0.628	0.690
0.16	0.133	0.199	0.264	0.330	0.396	0.461	0.527	0.593	0.658	0.724
0.17	0.133	0.202	0.272	0.341	0.411	0.480	0.549	0.619	0.688	0.757
0.18	0.133	0.206	0.279	0.352	0.423	0.498	0.571	0.644	0.717	0.791
0.19	0.133	0.210	0.286	0.363	0.440	0.516	0.593	0.670	0.747	0.823
0.20	0.133	0.213	0.292	0.372	0.452	0.532	0.611	0.691	0.771	0.850
0.21	0.133	0.215	0.297	0.379	0.461	0.543	0.625	0.707	0.789	0.871
0.22	0.133	0.217	0.302	0.386	0.470	0.555	0.639	0.723	0.808	0.892
0.23	0.133	0.220	0.306	0.393	0.479	0.566	0.653	0.739	0.826	0.912
0.24	0.133	0.222	0.311	0.400	0.488	0.577	0.666	0.755	0.844	0.933
0.25	0.133	0.224	0.315	0.406	0.497	0.589	0.680	0.771	0.862	0.953
0.26	0.133	0.226	0.320	0.413	0.506	0.600	0.693	0.786	0.880	0.973
0.27	0.133	0.229	0.324	0.420	0.515	0.611	0.706	0.802	0.897	0.993
0.28	0.133	0.231	0.328	0.426	0.524	0.622	0.719	0.817	0.915	1.012
0.29	0.133	0.233	0.333	0.433	0.532	0.632	0.732	0.832	0.932	1.032
0.30	0.133	0.235	0.337	0.439	0.541	0.643	0.745	0.847	0.949	1.051
0.31	0.133	0.237	0.341	0.445	0.550	0.654	0.758	0.862	0.966	1.070
0.32	0.133	0.239	0.346	0.452	0.558	0.664	0.770	0.877	0.983	1.089
0.33	0.133	0.241	0.350	0.458	0.566	0.675	0.783	0.891	1.000	1.108
0.34	0.133	0.243	0.354	0.464	0.575	0.685	0.795	0.906	1.016	1.127
0.35	0.133	0.245	0.358	0.470	0.583	0.695	0.808	0.920	1.033	1.145
0.36	0.133	0.248	0.362	0.476	0.591	0.705	0.820	0.934	1.049	1.163
0.37	0.133	0.250	0.366	0.483	0.599	0.716	0.832	0.949	1.065	1.181
0.38	0.133	0.252	0.370	0.489	0.607	0.725	0.844	0.962	1.081	1.199
0.39	0.133	0.254	0.374	0.494	0.615	0.735	0.856	0.976	1.097	1.217
0.40	0.133	0.255	0.378	0.500	0.623	0.745	0.868	0.990	1.112	1.235
0.41	0.133	0.257	0.382	0.506	0.630	0.755	0.879	1.004	1.128	1.252
0.42	0.133	0.259	0.386	0.512	0.638	0.764	0.891	1.017	1.143	1.270
0.43	0.133	0.261	0.389	0.518	0.646	0.774	0.902	1.030	1.158	1.287
0.44	0.133	0.263	0.393	0.523	0.653	0.783	0.913	1.043	1.174	1.304
0.45	0.133	0.265	0.397	0.529	0.661	0.793	0.925	1.056	1.188	1.320

As in the Original Standard, this Page is Intentionally Left Blank

# COMPRESSION MEMBERS





As in the Original Standard, this Page is Intentionally Left Blank

### 3. COMPRESSION MEMBERS

#### 3.1 AXIALLY LOADED COMPRESSION MEMBERS

All compression members are to be designed for a minimum eccentricity of load in two principal directions. Clause 24.4 of the Code specifies the following minimum eccentricity,  $e_{min}$  for the design of columns:

$$e_{min} = \frac{l}{500} + \frac{D}{30}, \text{ subject to a minimum of } 2 \text{ cm.}$$

where

- $l$  is the unsupported length of the column (see 24.1.3 of the Code for definition of unsupported length), and
- $D$  is the lateral dimension of the column in the direction under consideration.

After determining the eccentricity, the section should be designed for combined axial load and bending (see 3.2). However, as a simplification, when the value of the minimum eccentricity calculated as above is less than or equal to  $0.05D$ , 38.3 of the Code permits the design of short axially loaded compression members by the following equation:

$$P_u = 0.4 f_{ck} A_c + 0.67 f_y A_{sc}$$

where

- $P_u$  is the axial load (ultimate),
- $A_c$  is the area of concrete, and
- $A_{sc}$  is the area of reinforcement.

The above equation can be written as

$$P_u = 0.4 f_{ck} \left( A_g - \frac{pA_g}{100} \right) + 0.67 f_y \frac{pA_g}{100}$$

where

- $A_g$  is the gross area of cross section, and
- $p$  is the percentage of reinforcement.

Dividing both sides by  $A_g$ ,

$$\begin{aligned} \frac{P_u}{A_g} &= 0.4 f_{ck} \left( 1 - \frac{p}{100} \right) + 0.67 f_y \frac{p}{100} \\ &= 0.4 f_{ck} + \frac{p}{100} (0.67 f_y - 0.4 f_{ck}) \end{aligned}$$

Charts 24 to 26 can be used for designing short columns in accordance with the above equations. In the lower section of these charts,  $P_u/A_g$  has been plotted against reinforcement percentage  $p$  for different grades of concrete. If the cross section of the column is known,  $P_u/A_g$  can be calculated and the reinforcement percentage read from the chart. In the upper section of the charts,  $P_u/A_g$  is plotted against  $P_u$  for various values of  $A_g$ . The combined use of the upper and

lower sections would eliminate the need for any calculation. This is particularly useful as an aid for deciding the sizes of columns at the preliminary design stage of multi-storeyed buildings.

#### Example 5 Axially Loaded Column

Determine the cross section and the reinforcement required for an axially loaded column with the following data:

Factored load	3 000 kN
Concrete grade	M20
Characteristic strength of reinforcement	415 N/mm <sup>2</sup>
Unsupported length of column	3.0 m

The cross-sectional dimensions required will depend on the percentage of reinforcement. Assuming 1.0 percent reinforcement and referring to Chart 25,

Required cross-sectional area of column,

$$A_g = 2 700 \text{ cm}^2$$

Provide a section of 60 × 45 cm.

$$\begin{aligned} \text{Area of reinforcement, } A_s &= 1.0 \times \frac{60 \times 45}{100} \\ &= 27 \text{ cm}^2 \end{aligned}$$

We have to check whether the minimum eccentricity to be considered is within 0.05 times the lateral dimensions of the column. In the direction of longer dimension,

$$\begin{aligned} e_{min} &= \frac{l}{500} + \frac{D}{30} \\ &= \frac{3.0 \times 10^2}{500} + \frac{60}{30} = 0.6 + 2.0 = 2.6 \text{ cm} \end{aligned}$$

$$\text{or, } e_{min}/D = 2.6/60 = 0.043$$

In the direction of the shorter dimension,

$$\begin{aligned} e_{min} &= \frac{3.0 \times 10^2}{500} + \frac{45}{30} = 0.6 + 1.5 \\ &= 2.1 \text{ cm} \end{aligned}$$

$$\text{or, } e_{min}/b = 2.1/45 = 0.047$$

The minimum eccentricity ratio is less than 0.05 in both directions. Hence the design of the section by the simplified method of 38.3 of the Code is valid.

#### 3.2 COMBINED AXIAL LOAD AND UNIAXIAL BENDING

As already mentioned in 3.1, all compression members should be designed for

minimum eccentricity of load. It should always be ensured that the section is designed for a moment which is not less than that due to the prescribed minimum eccentricity.

**3.2.1 Assumptions**—Assumptions (a), (c), (d) and (e) for flexural members (see 2.1) are also applicable to members subjected to combined axial load and bending. The assumption (b) that the maximum strain in concrete at the outermost compression fibre is 0.0035 is also applicable when the neutral axis lies within the section and in the limiting case when the neutral axis lies along one edge of the section; in the latter case the strain varies from 0.0035 at the highly

compressed edge to zero at the opposite edge. For purely axial compression, the strain is assumed to be uniformly equal to 0.002 across the section [see 38.1(a) of the Code]. The strain distribution lines for these two cases intersect each other at a depth of  $\frac{3D}{7}$  from the highly compressed edge. This point is assumed to act as a fulcrum for the strain distribution line when the neutral axis lies outside the section (see Fig. 7). This leads to the assumption that the strain at the highly compressed edge is 0.0035 minus 0.75 times the strain at the least compressed edge [see 38.1(b) of the Code].

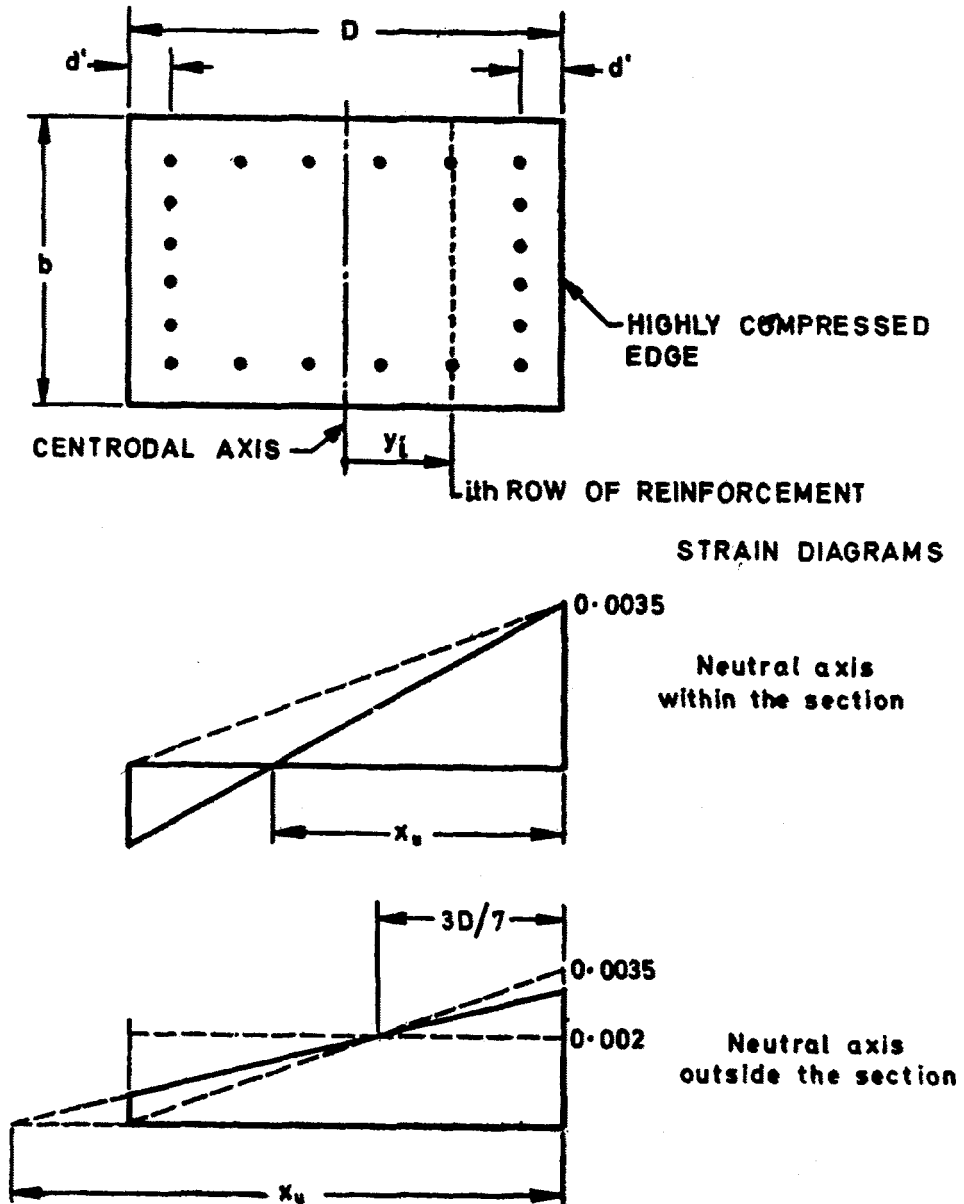


FIG. 7 COMBINED AXIAL LOAD AND UNIAXIAL BENDING

3.2.2 *Stress Block Parameters When the Neutral Axis Lies Outside the Section*—When the neutral axis lies outside the section, the shape of the stress block will be as indicated in Fig. 8. The stress is uniformly  $0.446 f_{ck}$  for a distance of  $\frac{3D}{7}$  from the highly compressed edge because the strain is more than 0.002 and thereafter the stress diagram is parabolic.

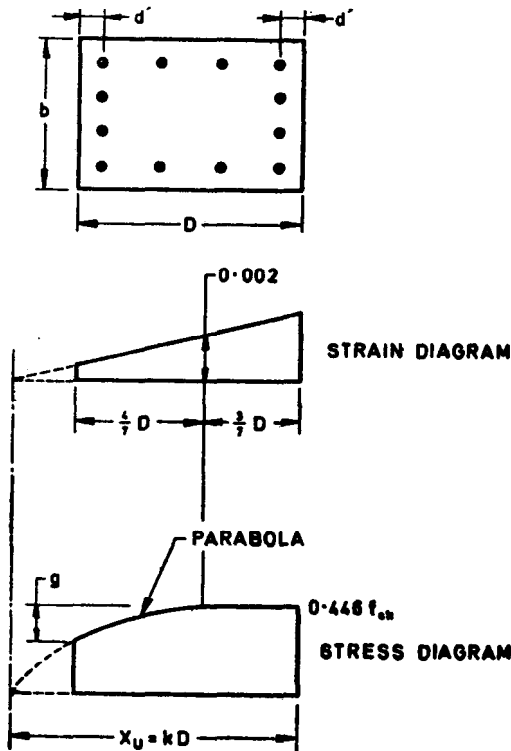


FIG. 8 STRESS BLOCK WHEN THE NEUTRAL AXIS LIES OUTSIDE THE SECTION

Let  $x_u = kD$  and let  $g$  be the difference between the stress at the highly compressed edge and the stress at the least compressed edge. Considering the geometric properties of a parabola,

$$g = 0.446 f_{ck} \left[ \frac{\frac{4}{7} D}{kD - \frac{3}{7} D} \right]^2$$

$$= 0.446 f_{ck} \left( \frac{4}{7k-3} \right)^2$$

Area of stress block

$$= 0.446 f_{ck} D - \frac{g}{3} \left( \frac{4}{7} D \right)$$

$$= 0.446 f_{ck} D - \frac{4}{21} g D$$

$$= 0.446 f_{ck} D \left[ 1 - \frac{4}{21} \left( \frac{4}{7k-3} \right)^2 \right]$$

The centroid of the stress block will be found by taking moments about the highly compressed edge.

Moment about the highly compressed edge

$$= 0.446 f_{ck} D \left( \frac{D}{2} \right) - \frac{4}{21} g D$$

$$\left[ \frac{3}{7} D + \frac{3}{4} \left( \frac{4}{7} D \right) \right]$$

$$= 0.446 f_{ck} \frac{D^2}{2} - \frac{8}{49} g D^2$$

The position of the centroid is obtained by dividing the moment by the area. For different values of  $k$ , the area of stress block and the position of its centroid are given in Table H.

TABLE H STRESS BLOCK PARAMETERS WHEN THE NEUTRAL AXIS LIES OUTSIDE THE SECTION (Clause 3.2.2)

$k = \frac{x_u}{D}$	AREA OF STRESS BLOCK	DISTANCE OF CENTROID FROM HIGHLY COMPRESSED EDGE
(1)	(2)	(3)
1.00	0.361 $f_{ck} D$	0.416 $D$
1.05	0.374 $f_{ck} D$	0.432 $D$
1.10	0.384 $f_{ck} D$	0.443 $D$
1.20	0.399 $f_{ck} D$	0.458 $D$
1.30	0.409 $f_{ck} D$	0.468 $D$
1.40	0.417 $f_{ck} D$	0.475 $D$
1.50	0.422 $f_{ck} D$	0.480 $D$
2.00	0.435 $f_{ck} D$	0.491 $D$
2.50	0.440 $f_{ck} D$	0.495 $D$
3.00	0.442 $f_{ck} D$	0.497 $D$
4.00	0.444 $f_{ck} D$	0.499 $D$

NOTE—Values of stress block parameters have been tabulated for values of  $k$  up to 4.00 for information only. For construction of interaction diagrams it is generally adequate to consider values of  $k$  up to about 1.2.

3.2.3 *Construction of Interaction Diagram*—Design charts for combined axial compression and bending are given in the form of interaction diagrams in which curves for  $P_u/bDf_{ck}$  versus  $M_u/bD^2 f_{ck}$  are plotted for different values of  $p/f_{ck}$ , where  $p$  is the reinforcement percentage.

3.2.3.1 For the case of purely axial compression, the points plotted on the  $y$ -axis of the charts are obtained as follows:

$$P_u = 0.446 f_{ck} b d + \frac{p b D}{100} (f_{sc} - 0.446 f_{ck})$$

$$\frac{P_u}{f_{ck} b D} = 0.446 + \frac{p}{100 f_{ck}} (f_{sc} - 0.446 f_{ck})$$

where

$f_{sc}$  is the compressive stress in steel corresponding to a strain of 0.002.

The second term within parenthesis represents the deduction for the concrete replaced by the reinforcement bars. This term is usually neglected for convenience. However, as a better approximation, a constant value corresponding to concrete grade M20 has been used in the present work, so that the error is negligibly small over the range of concrete mixes normally used. An accurate consideration of this term will necessitate the preparation of separate Charts for each grade of concrete, which is not considered worthwhile.

3.2.3.2 When bending moments are also acting in addition to axial load, the points for plotting the Charts are obtained by assuming different positions of neutral axis. For each position of neutral axis, the strain distribution across the section and the stress block parameters are determined as explained earlier. The stresses in the reinforcement are also calculated from the known strains. Thereafter the resultant axial force and the moment about the centroid of the section are calculated as follows:

a) *When the neutral axis lies outside the section*

$$P_u = C_1 f_{ck} b D + \sum_{i=1}^n \frac{p_i b D}{100} (f_{si} - f_{ci})$$

where

$C_1$  = coefficient for the area of stress block to be taken from Table H (see 3.2.2);

$p_i$  =  $\frac{A_{si}}{bD}$  where  $A_{si}$  is the area of reinforcement in the  $i$ th row;

$f_{si}$  = stress in the  $i$ th row of reinforcement, compression being positive and tension being negative;

$f_{ci}$  = stress in concrete at the level of the  $i$ th row of reinforcement; and

$n$  = number of rows of reinforcement.

The above expression can be written as

$$\frac{P_u}{f_{ck} b D} = C_1 + \sum_{i=1}^n \frac{p_i}{100 f_{ck}} (f_{si} - f_{ci})$$

Taking moment of the forces about the centroid of the section,

$$M_u = C_1 f_{ck} b D \left( \frac{D}{2} - C_2 D \right)$$

$$+ \sum_{i=1}^n \frac{p_i b D}{100} (f_{si} - f_{ci}) y_i$$

where

$C_2 D$  is the distance of the centroid of the concrete stress block, measured from the highly compressed edge; and

$y_i$  is the distance from the centroid of the section to the  $i$ th row of reinforcement; positive towards the highly compressed edge and negative towards the least compressed edge.

Dividing both sides of the equation by  $f_{ck} b D^2$ ,

$$\frac{M_u}{f_{ck} b D^2} = C_1 (0.5 - C_2) + \sum_{i=1}^n \frac{p_i}{f_{ck} 100} (f_{si} - f_{ci}) \left( \frac{y_i}{D} \right)$$

b) *When the neutral axis lies within the section*

In this case, the stress block parameters are simpler and they can be directly incorporated into the expressions which are otherwise same as for the earlier case. Thus we get the following expressions:

$$\frac{P_u}{f_{ck} b D} = 0.36 k + \sum_{i=1}^n \frac{p_i}{100 f_{ck}} (f_{si} - f_{ci})$$

$$\frac{M_u}{f_{ck} b D^2} = 0.36 k (0.5 - 0.416 k)$$

$$+ \sum_{i=1}^n \frac{p_i}{f_{ck} 100} (f_{si} - f_{ci}) \left( \frac{y_i}{D} \right)$$

where

$$k = \frac{\text{Depth of neutral axis}}{D}$$

An approximation is made for the value of  $f_{ci}$  for M20, as in the case of 3.2.3.1. For circular sections the procedure is same as above, except that the stress block parameters given earlier are not applicable; hence the section is divided into strips and summation is done for determining the forces and moments due to the stresses in concrete.

**3.2.3.3 Charts for compression with bending** — Charts for rectangular sections have been given for reinforcement on two sides (*Charts 27 to 38*) and for reinforcement on four sides (*Charts 39 to 50*). The Charts for the latter case have been prepared for a section with 20 bars equally distributed on all sides, but they can be used without significant error for any other number of bars (greater than 8) provided the bars are distributed equally on the four sides. The Charts for circular section (*Charts 51 to 62*) have been prepared for a section with 8 bars, but they can generally be used for sections with any number of bars but not less than 6. Charts have been given for three grades of steel and four values of  $d'/D$  for each case mentioned above.

The dotted lines in these charts indicate the stress in the bars nearest to the tension face of the member. The line for  $f_{st} = 0$  indicates that the neutral axis lies along the outermost row of reinforcement. For points lying above this line on the Chart, all the bars in the section will be in compression. The line for  $f_{st} = f_{yd}$  indicates that the outermost tension reinforcement reaches the design yield strength. For points below this line, the outermost tension reinforcement undergoes inelastic deformation while successive inner rows may reach a stress of  $f_{yd}$ . It should be noted that all these stress values are at the failure condition corresponding to the limit state of collapse and not at working loads.

**3.2.3.4 Charts for tension with bending** — These Charts are extensions of the Charts for compression with bending. Points for plotting these Charts are obtained by assuming low values of  $k$  in the expressions given earlier. For the case of purely axial tension,

$$P_u = \frac{pbD}{100} (0.87 f_y)$$

$$\frac{P_u}{f_{ck} bD} = \frac{p}{100 f_{ck}} (0.87 f_y)$$

*Charts 66 to 75* are given for rectangular sections with reinforcement on two sides and *Charts 76 to 85* are for reinforcement on four sides. It should be noted that these charts are meant for strength calculations

only; they do not take into account crack control which may be important for tension members.

---

**Example 6 Square Column with Uniaxial Bending**

Determine the reinforcement to be provided in a square column subjected to uniaxial bending, with the following data:

Size of column	45 × 45 cm
Concrete mix	M 25
Characteristic strength of reinforcement	415 N/mm <sup>2</sup>
Factored load (characteristic load multiplied by $\gamma_f$ )	2 500 kN
Factored moment	200 kN.m
Arrangement of reinforcement:	(a) On two sides (b) On four sides

(Assume moment due to minimum eccentricity to be less than the actual moment).

Assuming 25 mm bars with 40 mm cover,  $d' = 40 + 12.5 = 52.5 \text{ mm} = 5.25 \text{ cm}$   
 $d'/D = 5.25/45 = 0.12$

Charts for  $d'/D = 0.15$  will be used

$$\frac{P_u}{f_{ck} bD} = \frac{2\,500 \times 10^3}{25 \times 45 \times 45 \times 10^2} = 0.494$$

$$\frac{M_u}{f_c k b D^2} = \frac{200 \times 10^6}{25 \times 45 \times 45 \times 45 \times 10^3} = 0.088$$

a) Reinforcement on two sides, Referring to *Chart 33*,

$$p/f_{ck} = 0.09$$

Percentage of reinforcement,

$$p = 0.09 \times 25 = 2.25$$

$$A_s = p bD/100 = 2.25 \times 45 \times 45/100 = 45.56 \text{ cm}^2$$

b) Reinforcement on four sides from *Chart 45*,

$$p/f_{ck} = 0.10$$

$$p = 0.10 \times 25 = 2.5$$

$$A_s = 2.5 \times 45 \times 45/100 = 50.63 \text{ cm}^2$$


---

**Example 7 Circular Column with Uniaxial Bending**

Determine the reinforcement to be provided in a circular column with the following data:

Diameter of column	50 cm
Grade of concrete	M 20
Characteristic strength of reinforcement	250 N/mm <sup>2</sup> for bars up to 20 mm $\phi$ 240 N/mm <sup>2</sup> for bars over 20 mm $\phi$

Factored load 1 600 kN  
 Factored moment 125 kN.m  
 Lateral reinforcement:

- (a) Hoop reinforcement  
 (b) Helical reinforcement

(Assume moment due to minimum eccentricity to be less than the actual moment).

Assuming 25 mm bars with 40 mm cover,  
 $d' = 40 \times 12.5 = 52.5 \text{ mm} = 5.25 \text{ cm}$   
 $d'/D = 5.25/50 = 0.105$

Charts for  $d'/D = 0.10$  will be used.

(a) Column with hoop reinforcement

$$\frac{P_u}{f_{ck} D^3} = \frac{1\,600 \times 10^3}{20 \times 50 \times 50 \times 10^3} = 0.32$$

$$\frac{M_u}{f_{ck} D^3} = \frac{125 \times 10^6}{20 \times 50 \times 50 \times 50 \times 10^3} = 0.05$$

Referring to Chart 52, for  $f_y = 250 \text{ N/mm}^2$   
 $p/f_{ck} = 0.87$

$$p = 0.87 \times 20 = 1.74$$

$$A_s = p\pi D^2/400$$

$$= 1.74 \times \pi \times 50 \times 50/400 = 34.16 \text{ cm}^2$$

For  $f_y = 240 \text{ N/mm}^2$ ,  
 $A_s = 34.16 \times 250/240 = 35.58 \text{ cm}^2$

(b) Column with Helical Reinforcement

According to 38.4 of the Code, the strength of a compression member with helical reinforcement is 1.05 times the strength of a similar member with lateral ties. Therefore, the given load and moment should be divided by 1.05 before referring to the chart.

Hence,

$$\frac{P_u}{f_{ck} D^2} = \frac{0.32}{1.05} = 0.305$$

$$\frac{M_u}{f_{ck} D^3} = \frac{0.05}{1.05} = 0.048$$

From Chart 52, for  $f_y = 250 \text{ N/mm}^2$ ,  
 $p/f_{ck} = 0.078$

$$p = 0.078 \times 20 = 1.56$$

$$A_s = 1.56 \times \pi \times 50 \times 50/400$$

$$= 30.63 \text{ cm}^2$$

For  $f_y = 240 \text{ N/mm}^2$ ,  $A_s = 30.63 \times 250/240$   
 $= 31.91 \text{ cm}^2$

According to 38.4.1 of the Code the ratio of the volume of helical reinforcement to the volume of the core shall not be less than  $0.36 (A_g/A_c - 1) f_{ck}/f_y$  where  $A_g$  is the gross area of the section and  $A_c$  is the area of the core measured to the outside diameter of the helix. Assuming 8 mm dia bars for the helix,

Core diameter =  $50 - 2(4.0 - 0.8)$   
 $= 43.6 \text{ cm}$

$$A_g/A_c = 50^2/43.6^2 = 1.315$$

$$0.36 (A_g/A_c - 1) f_{ck}/f_y$$

$$= 0.36 \times 0.315 \times 20/250$$

$$= 0.0091$$

Volume of helical reinforcement

$$\frac{\text{Volume of helical reinforcement}}{\text{Volume of core}} = \frac{A_{sh}\pi \cdot (42.8)}{\frac{\pi}{4} (43.6^2) s_h} = \frac{0.09 A_{sh}}{s_h}$$

where,  $A_{sh}$  is the area of the bar forming the helix and  $s_h$  is the pitch of the helix. In order to satisfy the code requirement,

$$0.09 A_{sh}/s_h \geq 0.0091$$

For 8 mm dia bar,  $A_{sh} = 0.503 \text{ cm}^2$

$$s_h \leq \frac{0.09 \times 0.503}{0.0091}$$

$$\leq 4.97 \text{ cm}$$

### 3.3 COMPRESSION MEMBERS SUBJECT TO BIAXIAL BENDING

Exact design of members subject to axial load and biaxial bending is extremely laborious. Therefore, the Code permits the design of such members by the following equation:

$$\left(\frac{M_{ux}}{M_{ux1}}\right)^{\alpha_n} + \left(\frac{M_{uy}}{M_{uy1}}\right)^{\alpha_n} \leq 1.0$$

where

$M_{ux}$ ,  $M_{uy}$  are the moments about x and y axes respectively due to design loads,  
 $M_{ux1}$ ,  $M_{uy1}$  are the maximum uniaxial moment capacities with an axial load  $P_u$ , bending about x and y axes respectively, and

$\alpha_n$  is an exponent whose value depends on  $P_u/P_{uz}$  (see table below) where  $P_{uz} = 0.45 f_{ck} A_c + 0.75 f_y A_s$ :

$P_u/P_{uz}$	$\alpha_n$
$\leq 0.2$	1.0
$\geq 0.8$	2.0

For intermediate values, linear interpolation may be done. Chart 63 can be used for evaluating  $P_{uz}$ .

For different values of  $P_u/P_{uz}$ , the appropriate value of  $\alpha_n$  has been taken and curves for the equation

$$\left(\frac{M_{ux}}{M_{ux1}}\right)^{\alpha_n} + \left(\frac{M_{uy}}{M_{uy1}}\right)^{\alpha_n} = 1.0$$

plotted in Chart 64.

**Example 8 Rectangular Column with Biaxial Bending**

Determine the reinforcement to be provided in a short column subjected to biaxial bending, with the following data:

Size of column	40 × 60 cm
Concrete mix	M 15
Characteristic strength of reinforcement	415 N/mm <sup>2</sup>
Factored load, $P_u$	1 600 kN
Factored moment acting parallel to the larger dimension, $M_{ux}$	120 kN
Factored moment acting parallel to the shorter dimension, $M_{uy}$	90 kN

Moments due to minimum eccentricity are less than the values given above.

Reinforcement is distributed equally on four sides.

As a first trial assume the reinforcement percentage,  $p=1.2$

$$p/f_{ck} = 1.2/15 = 0.08$$

Uniaxial moment capacity of the section about  $xx$ -axis:

$$d'/D = \frac{5.25}{60} = 0.0875$$

Chart for  $d'/D = 0.1$  will be used.

$$P_u/f_{ck} bD = \frac{1600 \times 10^3}{15 \times 40 \times 60 \times 10^3} = 0.444$$

Referring to Chart 44,

$$M_u/f_{ck} bD^2 = 0.09$$

$$\therefore M_{ux1} = 0.09 \times 15 \times 40 \times 60^2 \times 10^3/10^6 = 194.4 \text{ kN.m}$$

Uniaxial moment capacity of the section about  $yy$ -axis:

$$d'/D = \frac{5.25}{40} = 0.131$$

Chart for  $d'/D = 0.15$  will be used.

Referring to Chart 45,

$$M_u/f_{ck} bD^2 = 0.083$$

$$\therefore M_{uy1} = 0.083 \times 15 \times 60 \times 40^2 \times 10^3/10^6 = 119.52 \text{ kN.m}$$

Calculation of  $P_{uz}$ :

Referring to Chart 63 corresponding to  $p = 1.2$ ,  $f_y = 415$  and  $f_{ck} = 15$ ,

$$\frac{P_{uz}}{A_g} = 10.3 \text{ N/mm}^2$$

$$\therefore P_{uz} = 10.3 A_g = 10.3 \times 40 \times 60 \times 10^3/10^3 \text{ kN} = 2472 \text{ kN}$$

$$\frac{P_u}{P_{uz}} = \frac{1600}{2472} = 0.647$$

$$\frac{M_{ux}}{M_{ux1}} = \frac{120}{194.4} = 0.617$$

$$\frac{M_{uy}}{M_{uy1}} = \frac{90}{119.52} = 0.753$$

Referring to Chart 64, the permissible value of  $\frac{M_{ux}}{M_{ux1}}$  corresponding to the above values of  $\frac{M_{uy}}{M_{uy1}}$  and  $\frac{P_u}{P_{uz}}$  is equal to 0.58.

The actual value of 0.617 is only slightly higher than the value read from the Chart. This can be made up by slight increase in reinforcement.

$$A_s = \frac{1.2 \times 40 \times 60}{100} = 28.8 \text{ cm}^2$$

12 bars of 18 mm will give  $A_s = 30.53 \text{ cm}^2$

Reinforcement percentage provided,

$$p = \frac{30.53 \times 100}{60 \times 40} = 1.27$$

With this percentage, the section may be rechecked as follows:

$$p/f_{ck} = 1.27/15 = 0.0847$$

Referring to Chart 44,

$$\frac{M_u}{f_{ck} bD^2} = 0.095$$

$$\therefore M_{ux1} = 0.095 \times 15 \times 40 \times 60^2 \times 10^3/10^6 = 205.2 \text{ kN.m}$$

Referring to Chart 45

$$\frac{M_u}{f_{ck} bD^2} = 0.085$$

$$\therefore M_{uy1} = 0.085 \times 15 \times 60 \times 40^2 \times 10^3/10^6 = 122.4 \text{ kN.m}$$

Referring to Chart 63,

$$\frac{P_{uz}}{A_g} = 10.4 \text{ N/mm}^2$$

$$\therefore P_{uz} = 10.4 \times 60 \times 40 \times 10^3/10^3 = 2496 \text{ kN}$$

$$P_u/P_{uz} = \frac{1600}{2496} = 0.641$$

$$M_{ux}/M_{ux1} = \frac{120}{205.2} = 0.585$$

$$M_{uy}/M_{uy1} = \frac{90}{122.4} = 0.735$$

Referring to Chart 64,

Corresponding to the above values of  $\frac{M_{uy}}{M_{uy1}}$  and  $\frac{P_u}{P_{uz}}$ , the permissible value of

$$\frac{M_{ux}}{M_{ux1}}$$
 is 0.6.

Hence the section is O.K.



### 3.4 SLENDER COMPRESSION MEMBERS

When the slenderness ratio  $\frac{l_{ex}}{D}$  or  $\frac{l_{ey}}{b}$  of a compression member exceeds 12, it is considered to be a slender compression member (see 24.1.2 of the Code);  $l_{ex}$  and  $l_{ey}$  being the effective lengths with respect to the major axis and minor axis respectively. When a compression member is slender with respect to the major axis, an additional moment  $M_{ax}$  given by the following equation (modified as indicated later) should be taken into account in the design (see 38.7.1 of the Code):

$$M_{ax} = \frac{P_u D}{2000} \left( \frac{l_{ex}}{D} \right)^2$$

Similarly, if the column is slender about the minor axis an additional moment  $M_{ay}$  should be considered.

$$M_{ay} = \frac{P_u b}{2000} \left( \frac{l_{ey}}{b} \right)^2$$

The expressions for the additional moments can be written in the form of eccentricities of load, as follows:

$$M_{ax} = P_u e_{ax}$$

where

$$e_{ax} = \frac{D}{2000} \left( \frac{l_{ex}}{D} \right)^2$$

$$\frac{e_{ax}}{D} = \frac{1}{2000} \left( \frac{l_{ex}}{D} \right)^2$$

Table I gives the values  $\frac{e_{ax}}{D}$  or  $\frac{e_{ay}}{b}$  for different values of slenderness ratio.

TABLE I ADDITIONAL ECCENTRICITY FOR SLENDER COMPRESSION MEMBERS

(Clause 3.4)

$\frac{l_{ex}/D}{\text{or}} \frac{l_{ey}/b}$	$\frac{e_{ax}/D}{\text{or}} \frac{e_{ay}/b}$	$\frac{l_{ex}/D}{\text{or}} \frac{l_{ey}/b}$	$\frac{e_{ax}/D}{\text{or}} \frac{e_{ay}/b}$
(1)	(2)	(3)	(4)
12	0.072	25	0.313
13	0.085	30	0.450
14	0.098	35	0.613
15	0.113	40	0.800
16	0.128	45	1.013
17	0.145	50	1.250
18	0.162	55	1.513
19	0.181	60	1.800
20	0.200		

In accordance with 38.7.1.1 of the Code, the additional moments may be reduced by the multiplying factor  $k$  given below:

$$k = \frac{P_{uz} - P_u}{P_{uz} - P_b} < 1$$

where

$P_{uz} = 0.45 f_{ck} A_c + 0.75 f_y A_s$ , which may be obtained from Chart 63, and  $P_b$  is the axial load corresponding to the condition of maximum compressive strain of 0.0035 in concrete and tensile strain of 0.002 in outermost layer of tension steel.

Though this modification is optional according to the Code, it should always be taken advantage of, since the value of  $k$  could be substantially less than unity.

The value of  $P_b$  will depend on arrangement of reinforcement and the cover ratio  $d'/D$ , in addition to the grades of concrete and steel. The values of the coefficients required for evaluating  $P_b$  for various cases are given in Table 60. The values given in Table 60 are based on the same assumptions as for members with axial load and uniaxial bending.

The expression for  $k$  can be written as follows:

$$k = \frac{1 - P_u/P_{uz}}{1 - P_b/P_{uz}} < 1$$

Chart 65 can be used for finding the ratio of  $k$  after calculating the ratios  $P_u/P_{uz}$  and  $P_b/P_{uz}$ .

**Example 9 Slender Column (with biaxial bending)**

Determine the reinforcement required for a column which is restrained against sway, with the following data:

Size of column	40 × 30 cm
Concrete grade	M 30
Characteristic strength of reinforcement	415 N/mm <sup>2</sup>
Effective length for bending parallel to larger dimension, $l_{ex}$	6.0 m
Effective length for bending parallel to shorter dimension, $l_{ey}$	5.0 m
Unsupported length	7.0 m
Factored load	1 500 kN
Factored moment in the direction of larger dimension	40 kN.m at top and 22.5 kN.m at bottom

Factored moment in the direction of shorter dimension 30 kN.m at top and 20 kN.m at bottom

The column is bent in double curvature. Reinforcement will be distributed equally on four sides.

$$\frac{l_{ex}}{D} = \frac{6.0 \times 100}{40} = 15.0 > 12$$

$$\frac{l_{ey}}{b} = \frac{5.0 \times 100}{30} = 16.7 > 12$$

Therefore the column is slender about both the axes.

From Table I,

$$\text{For } \frac{l_{ex}}{D} = 15, e_x/D = 0.113$$

$$\text{For } \frac{l_{ey}}{b} = 16.7, e_y/b = 0.140$$

Additional moments:

$$M_{ax} = P_u e_x = 1500 \times 0.113 \times \frac{40}{100} = 67.8 \text{ kN.m}$$

$$M_{ay} = P_u e_y = 1500 \times 0.14 \times \frac{30}{100} = 63.0 \text{ kN.m}$$

The above moments will have to be reduced in accordance with 38.7.1.1 of the Code; but multiplication factors can be evaluated only if the reinforcement is known.

For first trial, assume  $p = 3.0$  (with reinforcement equally on all the four sides).

$$A_g = 40 \times 30 = 1200 \text{ cm}^2$$

From Chart 63,  $P_{uz}/A_g = 22.5 \text{ N/mm}^2$

$$\therefore P_{uz} = 22.5 \times 1200 \times 10^2/10^3 = 2700 \text{ kN}$$

Calculation of  $P_b$ :

Assuming 25 mm dia bars with 40 mm cover

$$d'/D \text{ (about } xx\text{-axis)} = \frac{5.25}{40} = 0.13$$

Chart or Table for  $d'/d = 0.15$  will be used.

$$d'/D \text{ (about } yy\text{-axis)} = \frac{5.25}{30} = 0.17$$

Chart or Table for  $d'/d = 0.20$  will be used.

From Table 60,

$$P_b \text{ (about } xx\text{-axis)} = \left( k_1 + k_2 \frac{p}{f_{ck}} \right) f_{ck} b D$$

$$P_{bx} = \left( 0.196 + 0.203 \times \frac{3}{30} \right) \times 30 \times 30 \times 40 \times 10^2/10^3 = 779 \text{ kN}$$

$$P_b \text{ (about } yy\text{-axis)} = \left( 0.184 + \frac{0.028 \times 3}{30} \right) \times 40 \times 30 \times 30 \times 10^2/10^3$$

$$P_{by} = 672 \text{ kN}$$

$$\therefore k_x = \frac{P_{uz} - P_u}{P_{uz} - P_{bx}} = \frac{2700 - 1500}{2700 - 779} = 0.625$$

$$k_y = \frac{P_{uz} - P_u}{P_{uz} - P_{by}} = \frac{2700 - 1500}{2700 - 672} = 0.592$$

The additional moments calculated earlier, will now be multiplied by the above values of  $k$ .

$$M_{ax} = 67.8 \times 0.625 = 42.4 \text{ kN.m}$$

$$M_{ay} = 63.0 \times 0.592 = 37.3 \text{ kN.m}$$

The additional moments due to slenderness effects should be added to the initial moments after modifying the initial moments as follows (see Note 1 under 38.7.1 of the Code):

$$M_{ux} = (0.6 \times 40 - 0.4 \times 22.5) = 15.0 \text{ kN.m}$$

$$M_{uy} = (0.6 \times 30 - 0.4 \times 20) = 10.0 \text{ kN.m}$$

The above actual moments should be compared with those calculated from minimum eccentricity consideration (see 24.4 of the Code) and greater value is to be taken as the initial moment for adding the additional moments.

$$e_x = \frac{l}{500} + \frac{D}{30} = \frac{700}{500} + \frac{40}{30} = 2.73 \text{ cm}$$

$$e_y = \frac{l}{500} + \frac{b}{30} = \frac{700}{500} + \frac{30}{30} = 2.4 \text{ cm}$$

Both  $e_x$  and  $e_y$  are greater than 2.0 cm.

Moments due to minimum eccentricity:

$$M_{ux} = 1500 \times \frac{2.73}{100} = 41.0 \text{ kN.m} > 15.0 \text{ kN.m}$$

$$M_{uy} = 1500 \times \frac{2.4}{100} = 36.0 \text{ kN.m} > 10.0 \text{ kN.m}$$

$\therefore$  Total moments for which the column is to be designed are:

$$M_{ux} = 41.0 + 42.4 = 83.4 \text{ kN.m}$$

$$M_{uy} = 36.0 + 37.3 = 73.3 \text{ kN.m}$$

The section is to be checked for biaxial bending.

$$P_u/f_{ck} b D = \frac{1500 \times 10^3}{30 \times 30 \times 40 \times 10^3} = 0.417$$

$$p/f_{ck} = \frac{3.0}{30} = 0.10$$

Referring to *Chart 45* ( $d'/D = 0.15$ ),

$$M_u/f_{ck} bD^2 = 0.104$$

$$\therefore M_{ux1} = 0.104 \times 30 \times 30 \times 40 \times 40 \times \frac{10^3}{10^6} \\ = 149.8 \text{ kN.m}$$

Referring to *Chart 46* ( $d'/D = 0.20$ ),

$$M_u/f_{ck} bD^2 = 0.096$$

$$\therefore M_{uy1} = 0.096 \times 30 \times 40 \times 30 \times 30 \times \frac{10^3}{10^6} \\ = 103.7 \text{ kN.m}$$

$$\frac{M_{ux}}{M_{ux1}} = \frac{83.4}{149.8} = 0.56$$

$$\frac{M_{uy}}{M_{uy1}} = \frac{73.3}{103.7} = 0.71$$

$$P_u/P_{uz} = \frac{1500}{2700} = 0.56$$

Referring to *Chart 64*, the maximum allowable value of  $M_{ux}/M_{ux1}$  corresponding to the above values of  $M_{uy}/M_{uy1}$  and  $P_u/P_{uz}$  is 0.58 which is slightly higher than the actual value of 0.56. The assumed reinforcement of 3.0 percent is therefore satisfactory.

$$A_s = pbD/100 = 3.0 \times 30 \times 40/100 \\ = 36.0 \text{ cm}^2$$

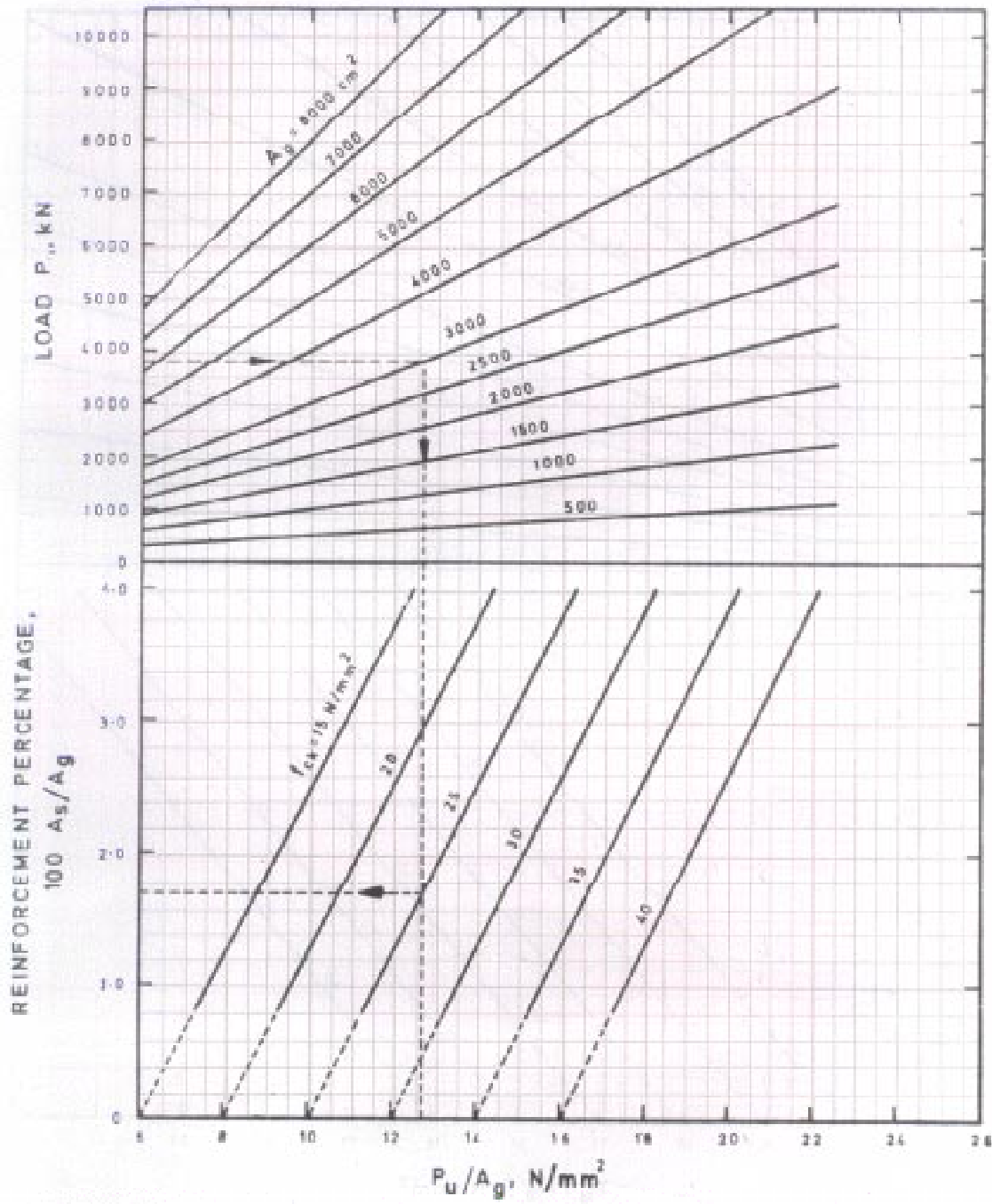

---

$f_y$   
250

$f_{ck}$   
15  
20  
25  
30  
35  
40

Chart 24 AXIAL COMPRESSION

$f_y = 250 \text{ N/mm}^2$

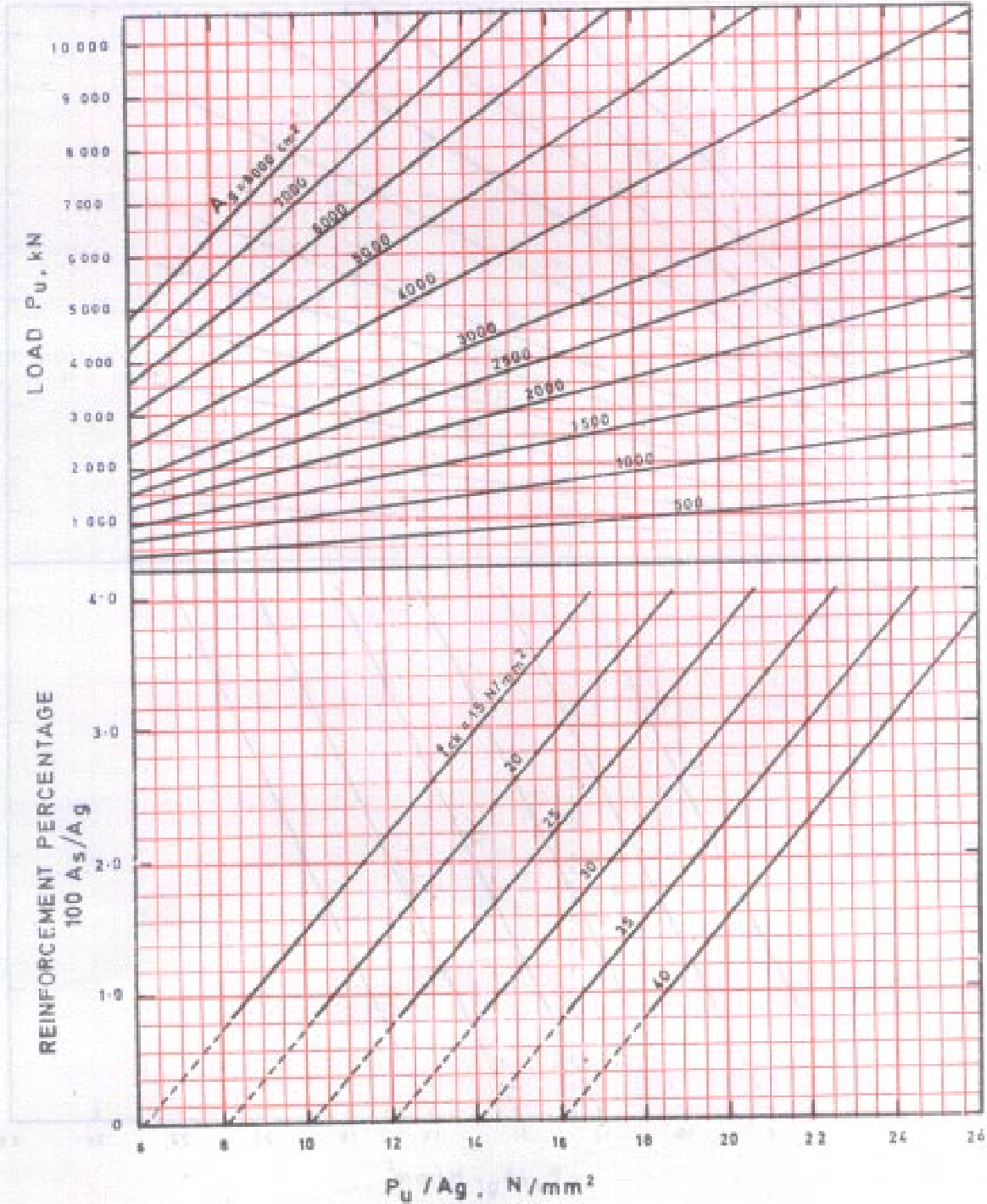


$f_y$   
415

$f_{ck}$   
15  
20  
25  
30  
35  
40

Chart 25 AXIAL COMPRESSION

$f_y = 415 \text{ N/mm}^2$

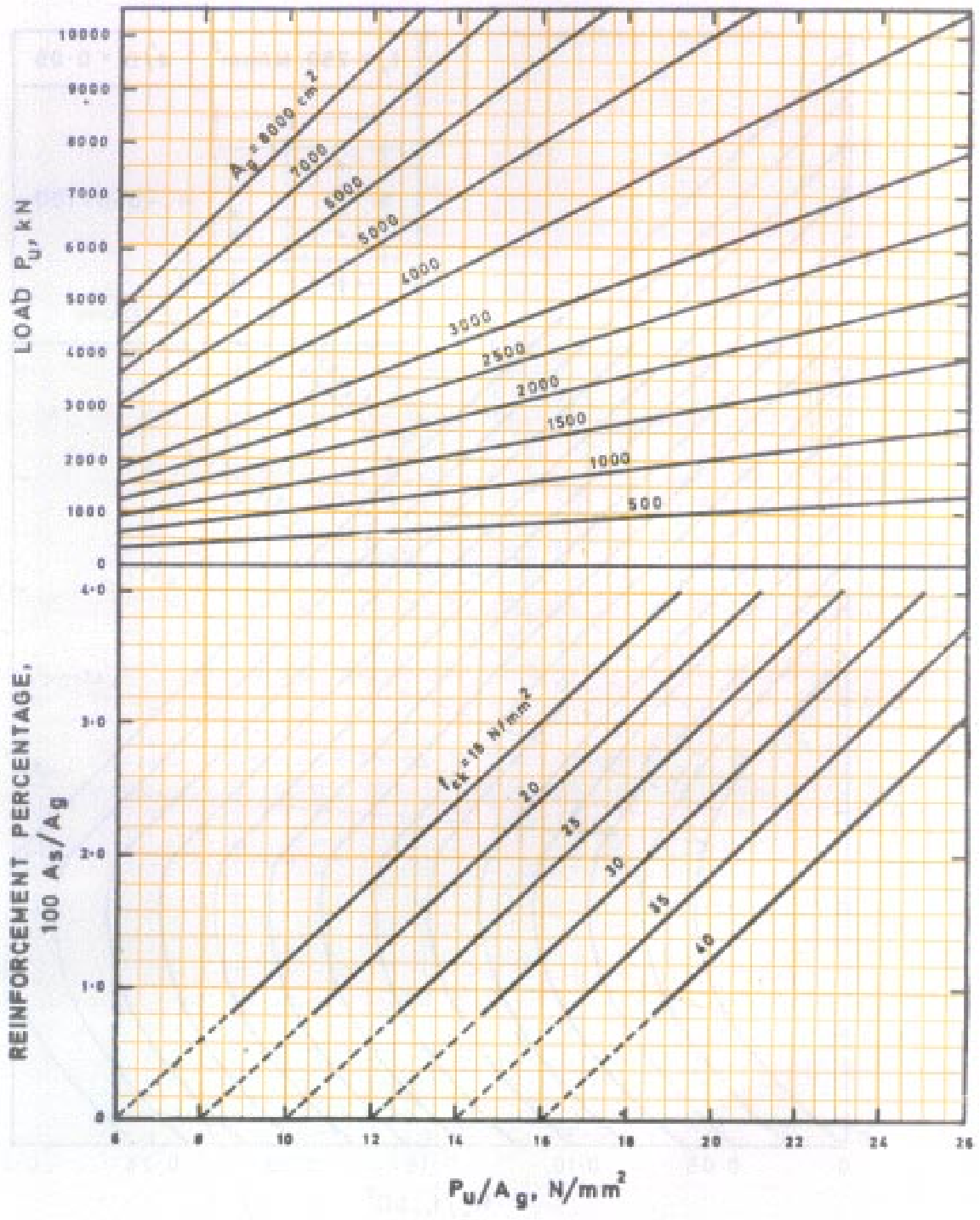


$f_y$   
500

$f_{ck}$   
15  
20  
25  
30  
35  
40

Chart 26 AXIAL COMPRESSION

$f_y = 500 \text{ N/mm}^2$



**Chart 27 COMPRESSION WITH BENDING — Rectangular Section — Reinforcement Distributed Equally on Two Sides**

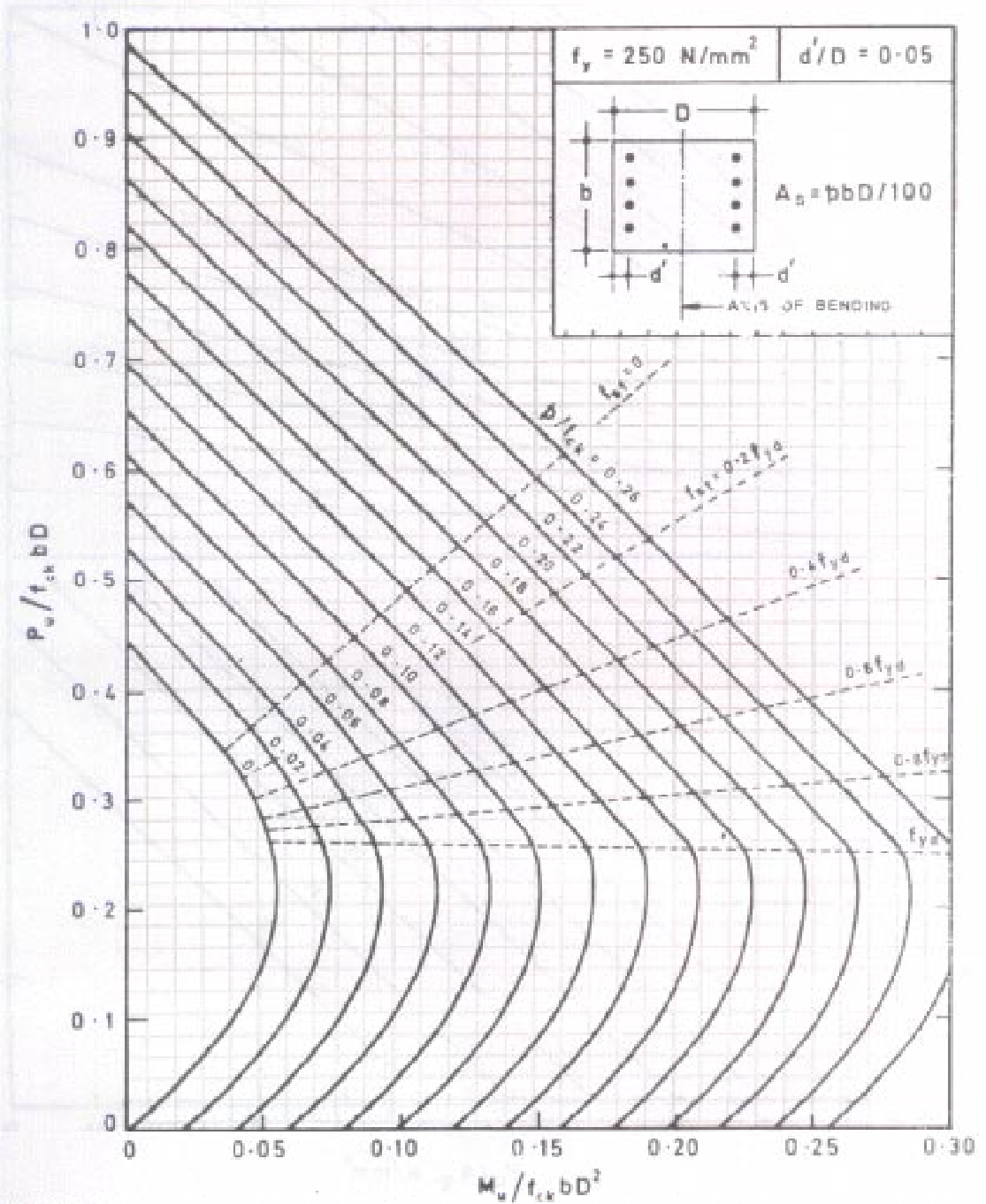
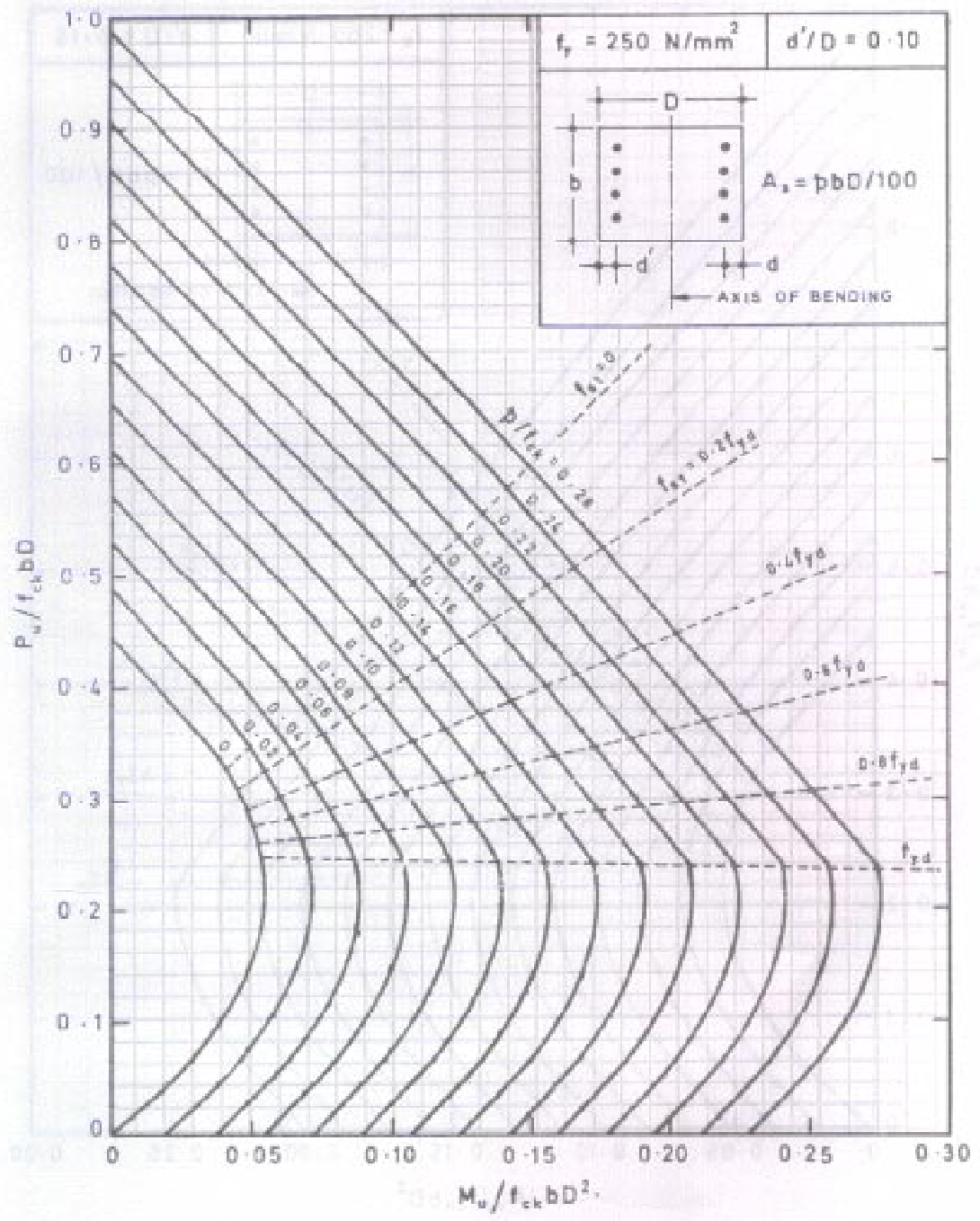
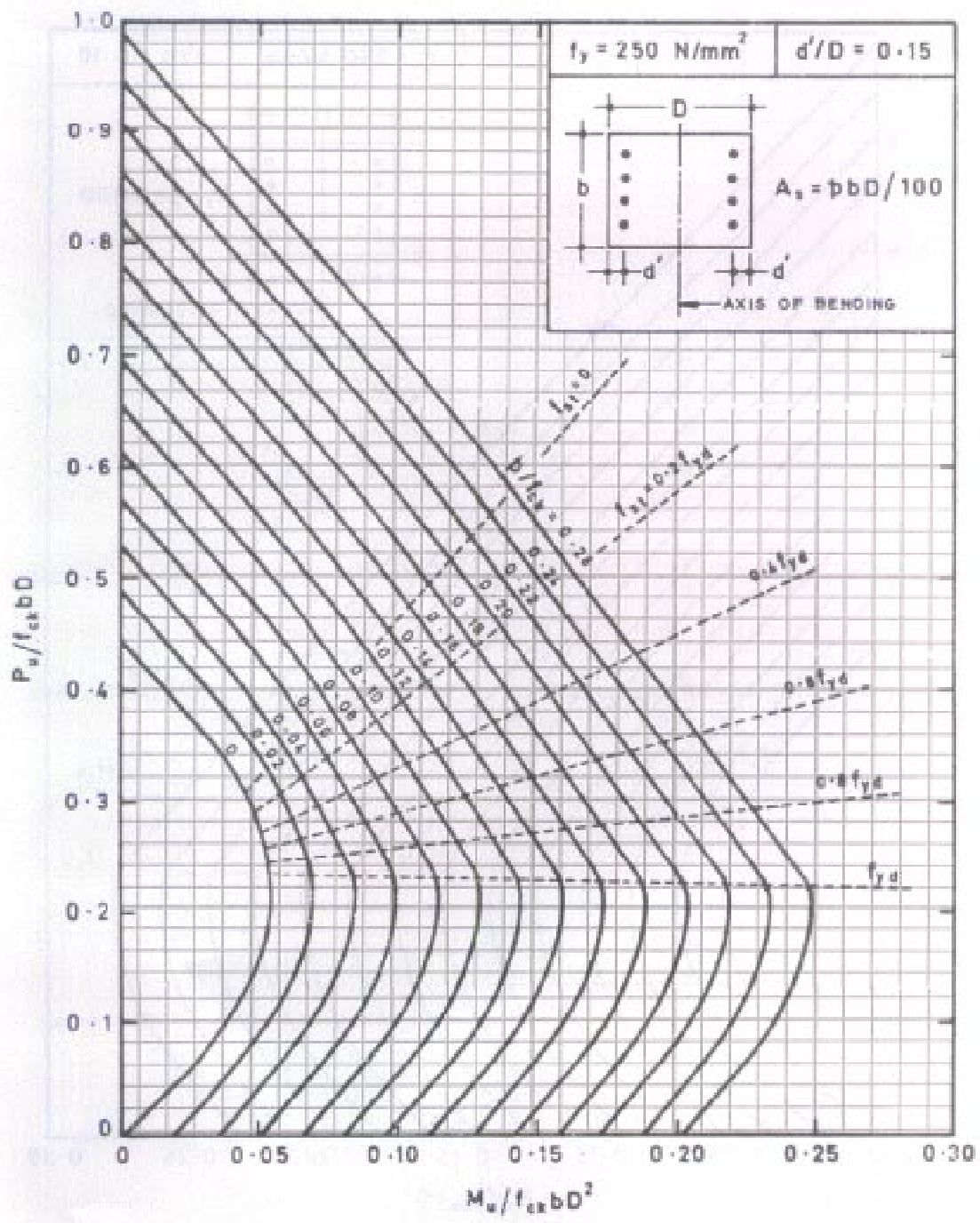




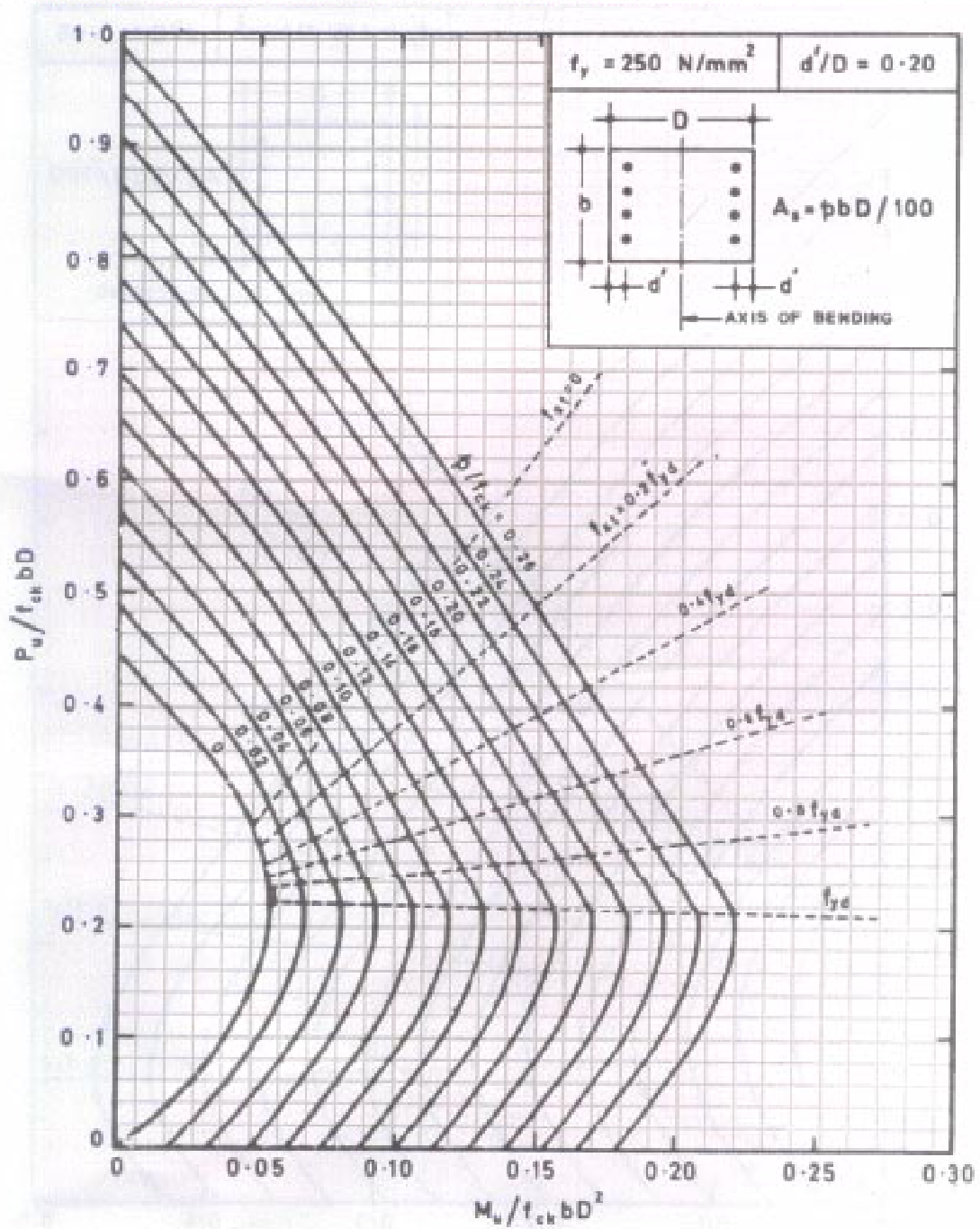
Chart 28 COMPRESSION WITH BENDING — Rectangular Section — Reinforcement Distributed Equally on Two Sides



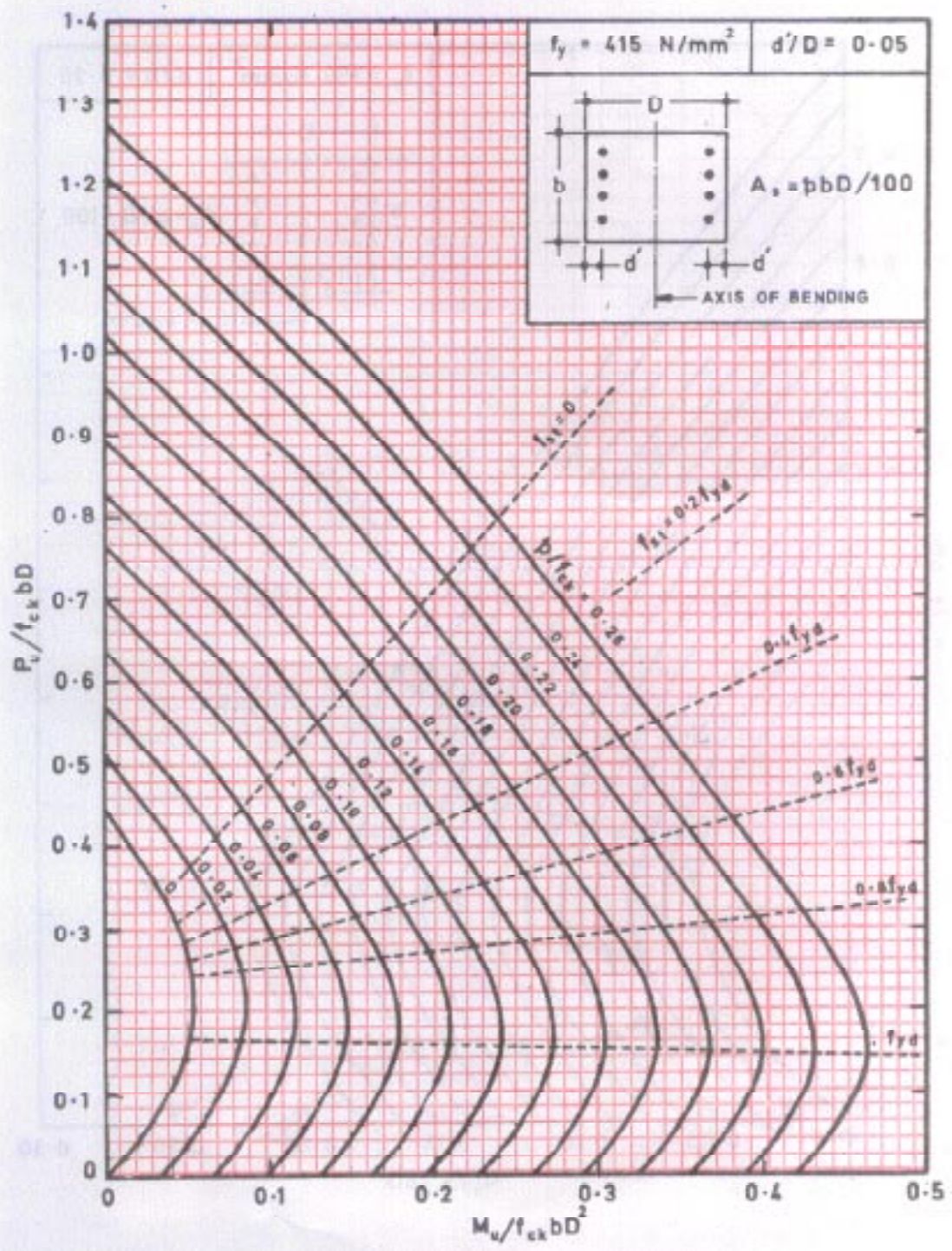
**Chart 29 COMPRESSION WITH BENDING – Rectangular Section – Reinforcement Distributed Equally on Two Sides**



**Chart 30 COMPRESSION WITH BENDING — Rectangular Section — Reinforcement Distributed Equally on Two Sides**

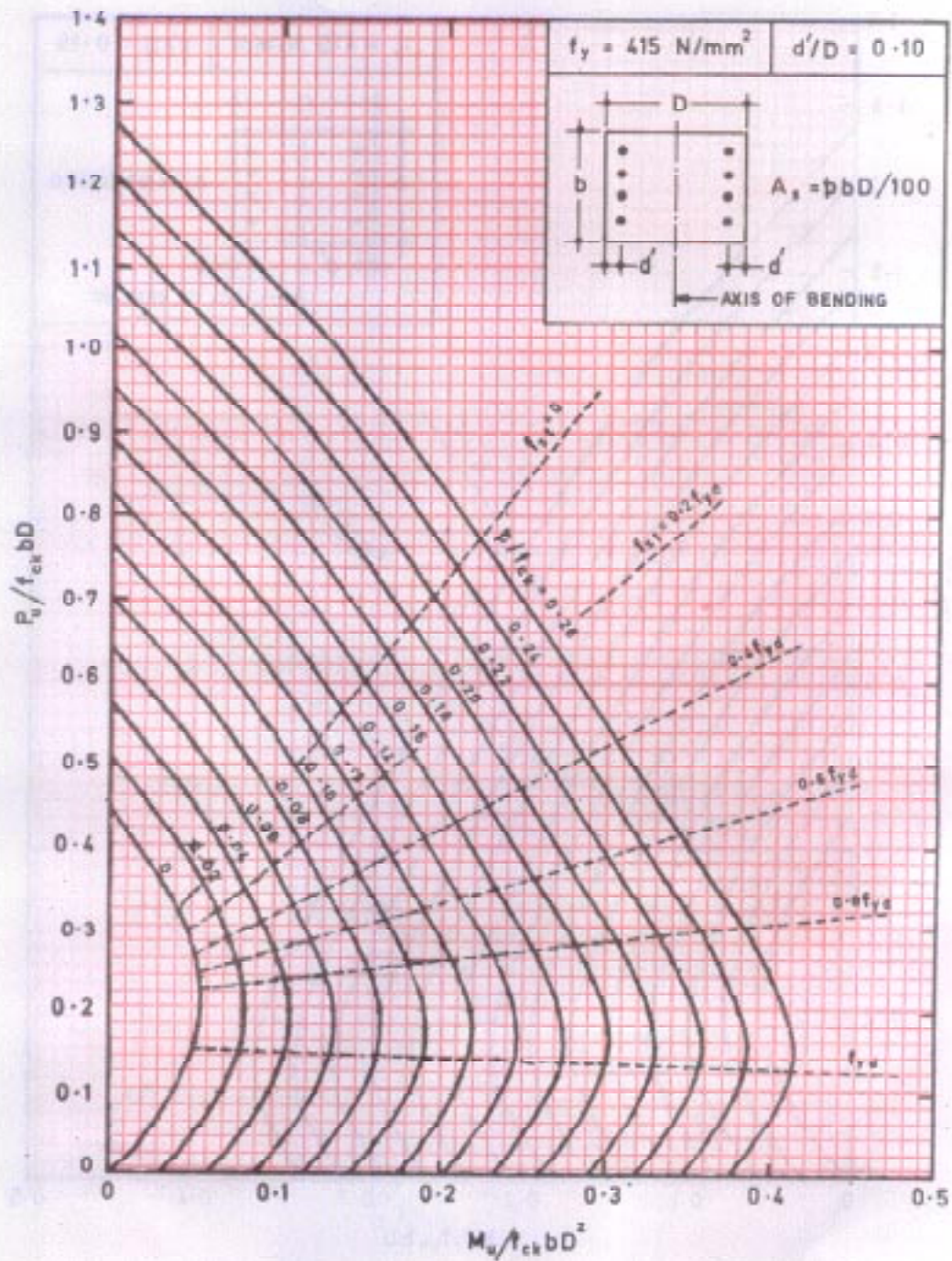


**Chart 31 COMPRESSION WITH BENDING — Rectangular Section — Reinforcement Distributed Equally on Two Sides**





**Chart 32 COMPRESSION WITH BENDING — Rectangular Section — Reinforcement Distributed Equally on Two Sides**



**Chart 33 COMPRESSION WITH BENDING — Rectangular Section — Reinforcement Distributed Equally on Two Sides**

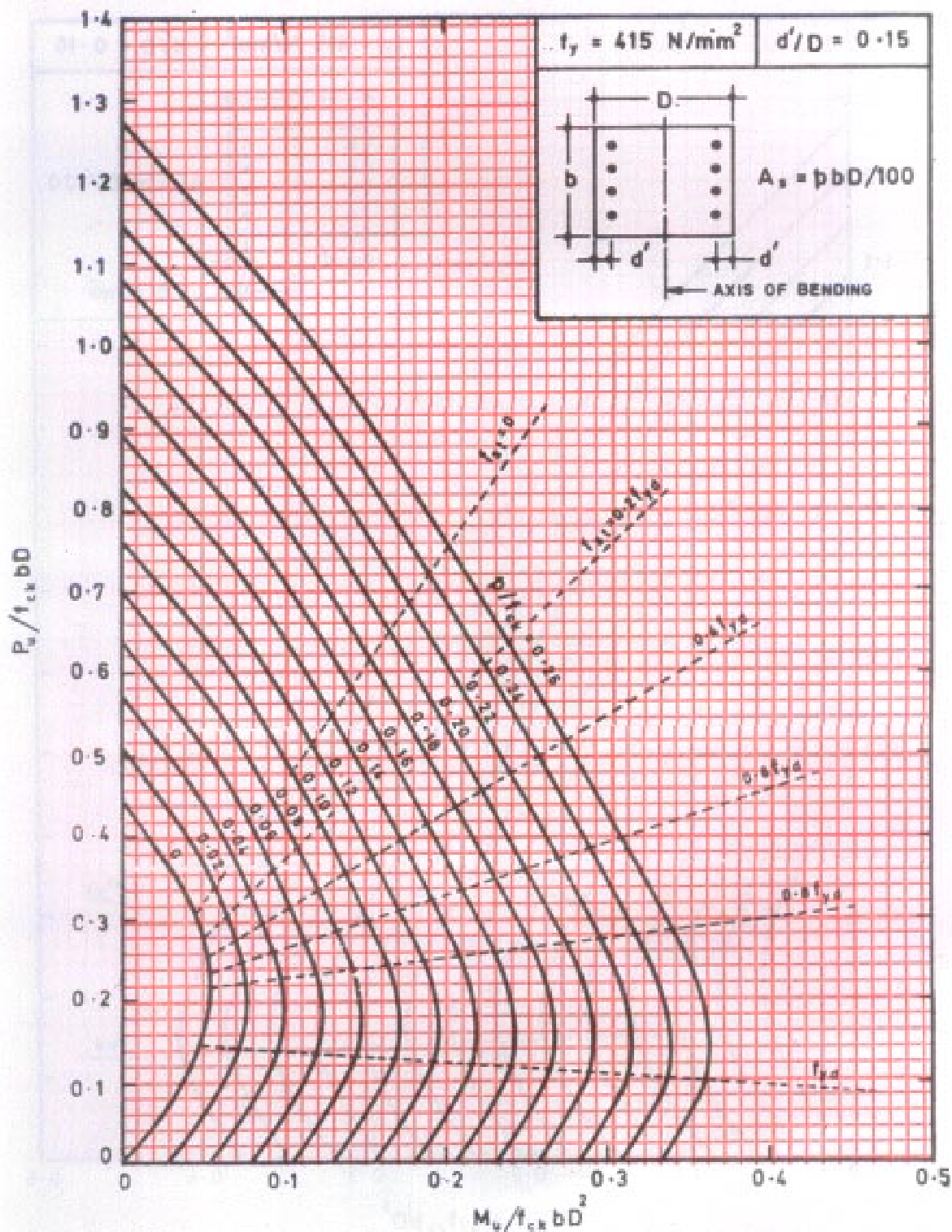




Chart 34 COMPRESSION WITH BENDING — Rectangular Section — Reinforcement Distributed Equally on Two Sides

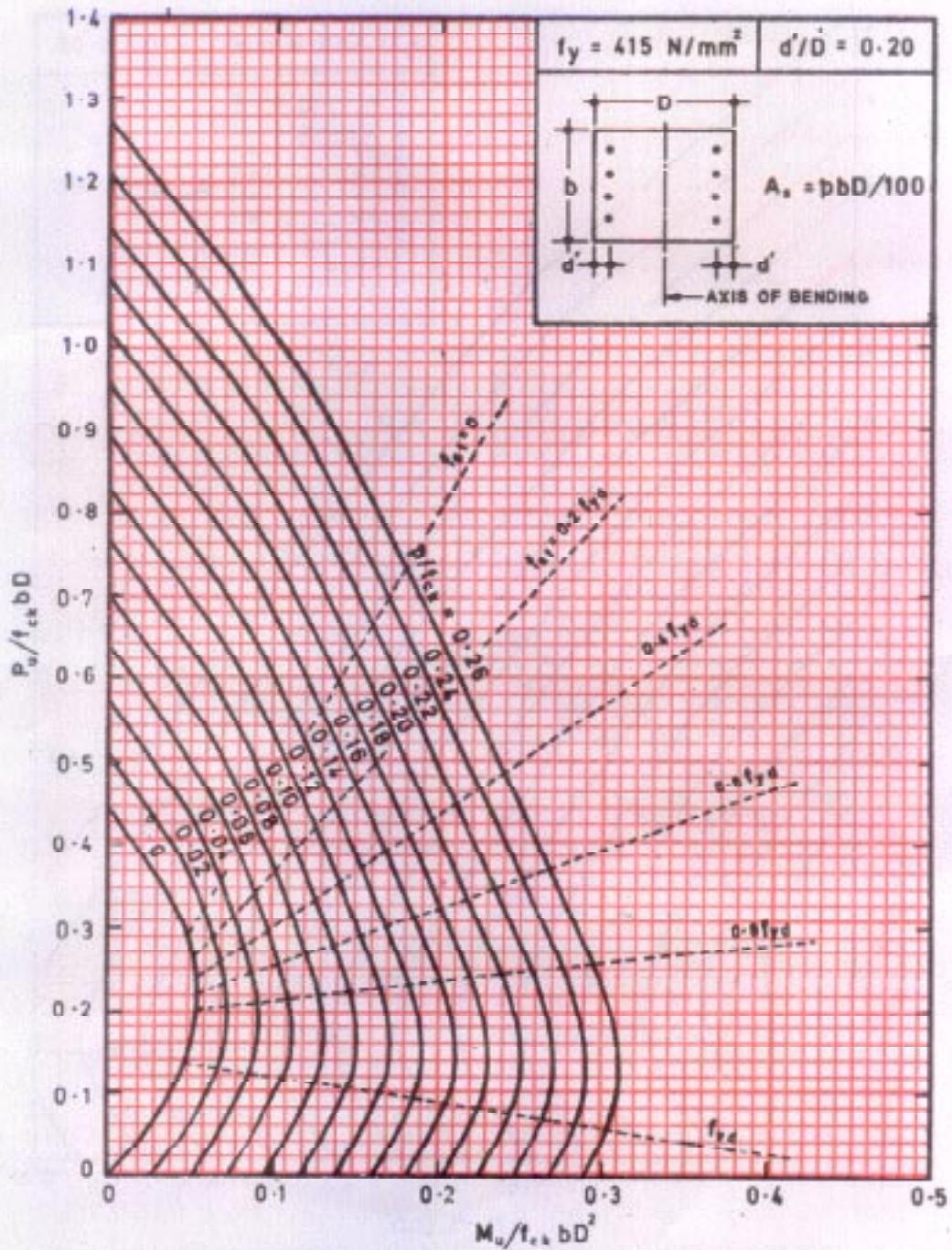
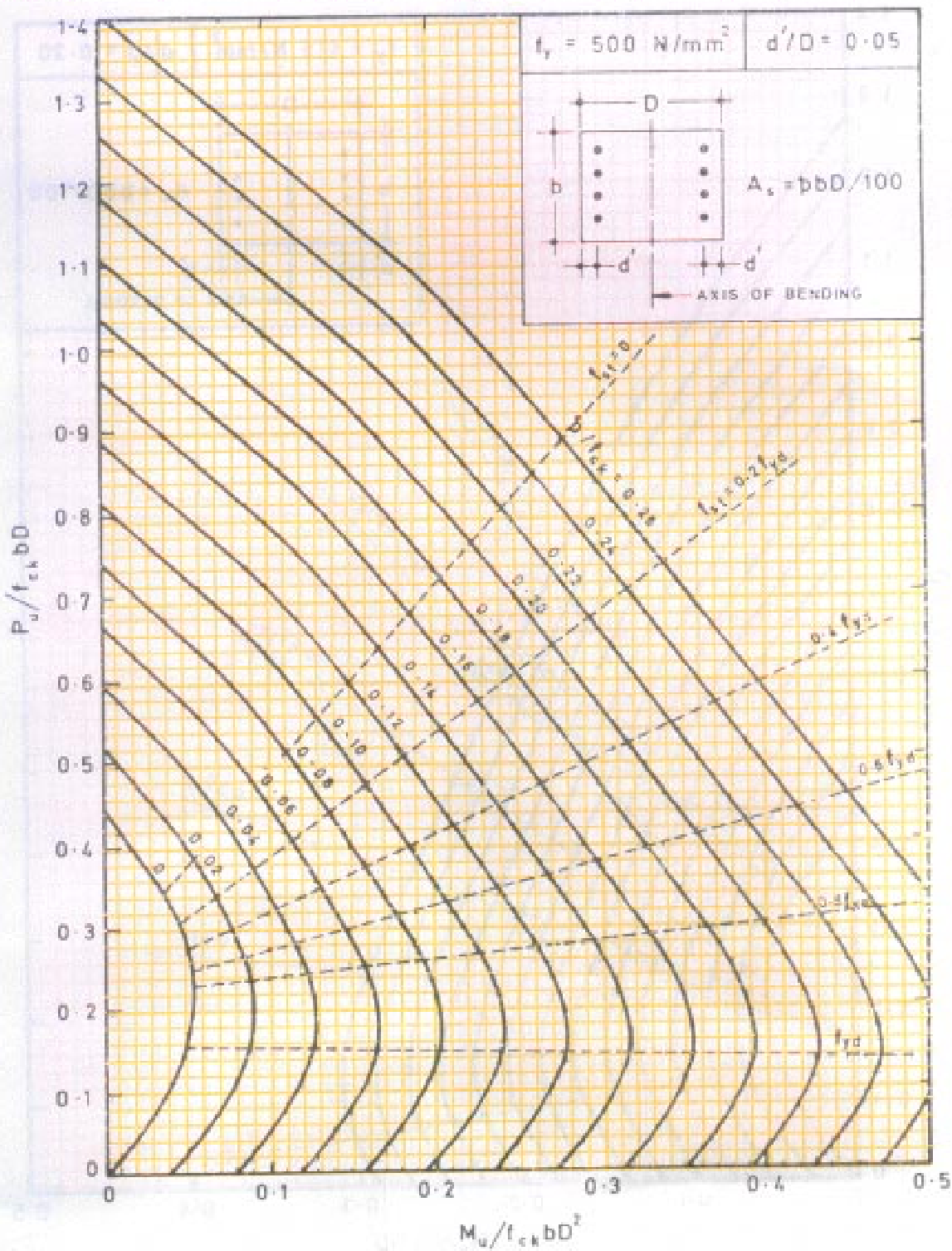
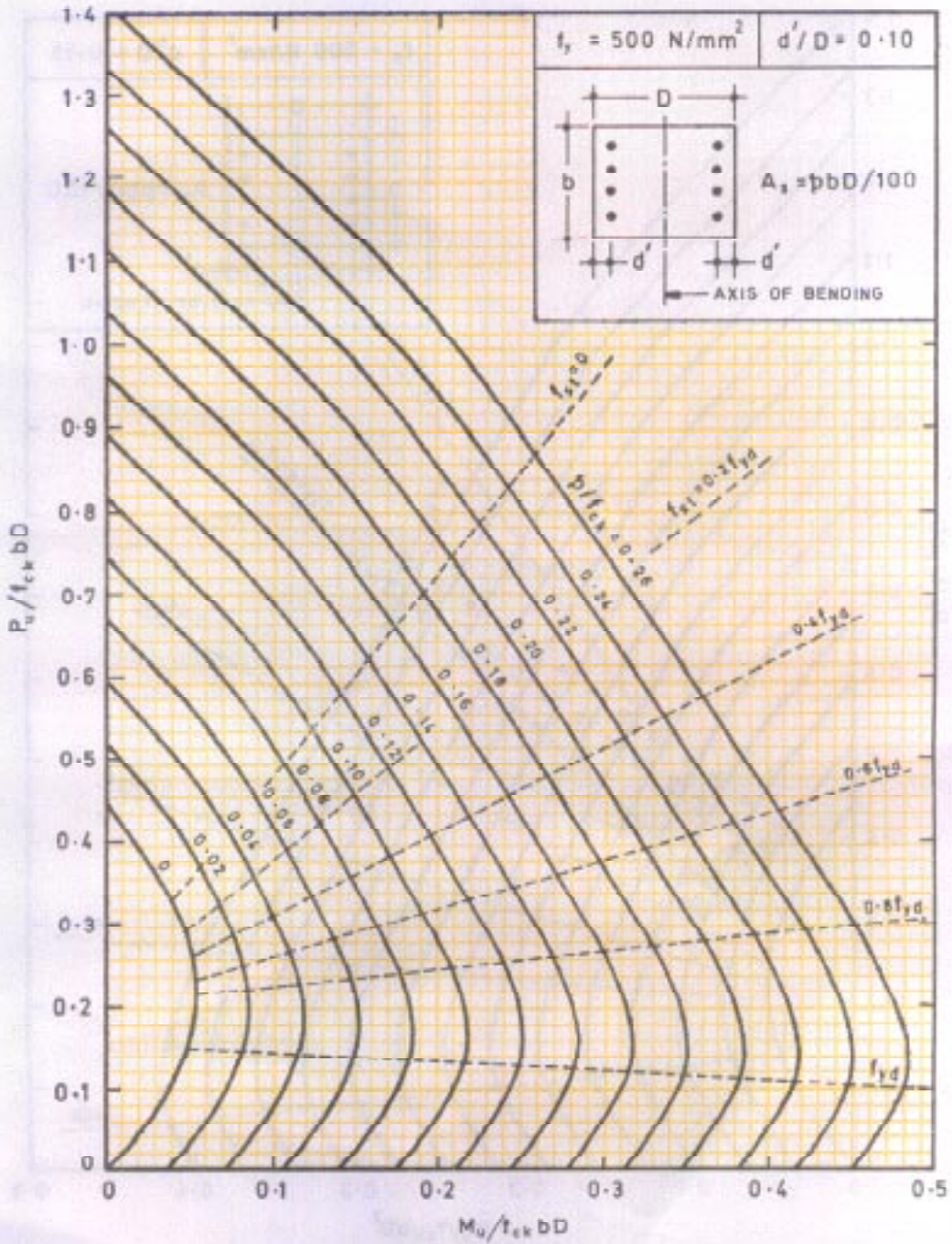




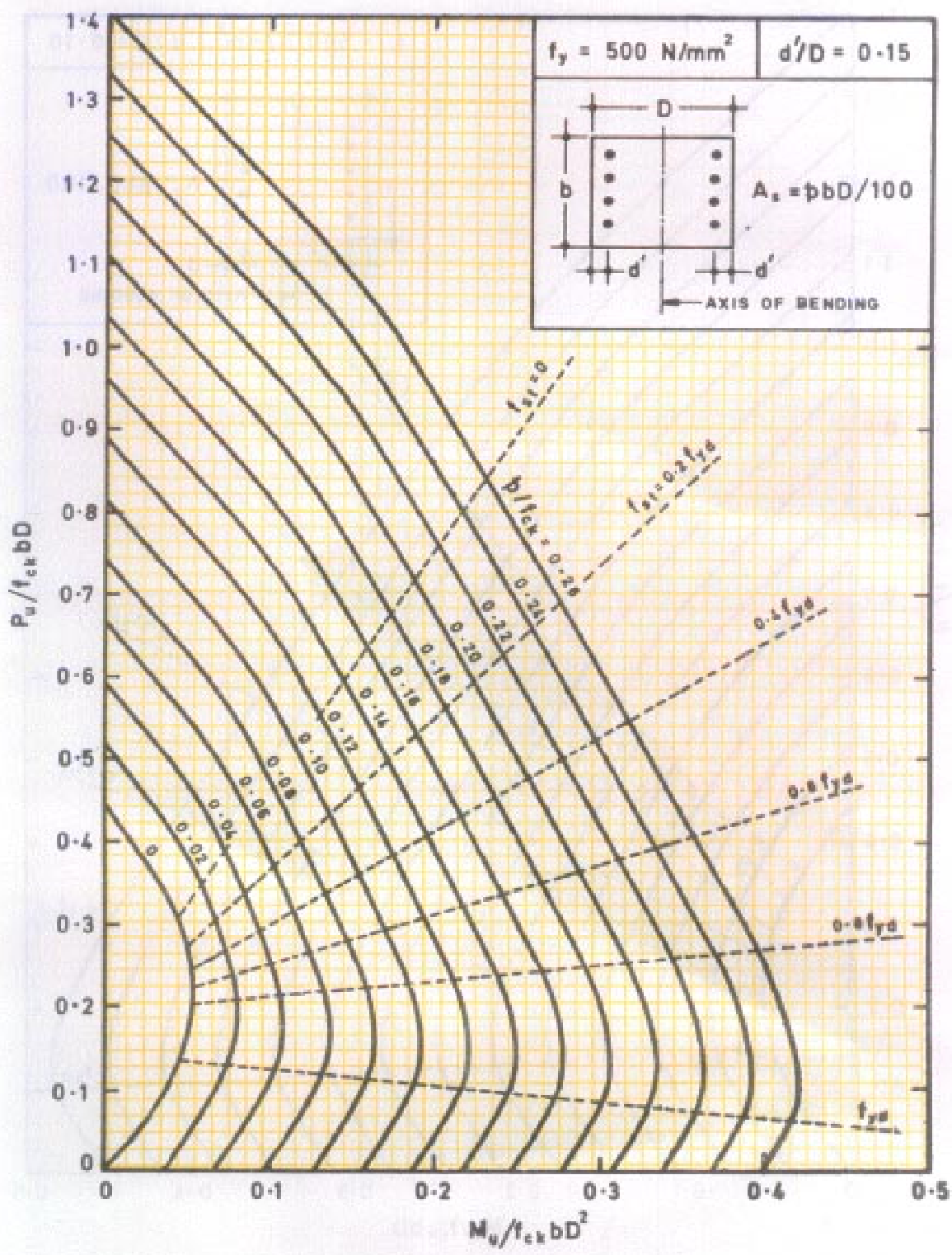
Chart 35 COMPRESSION WITH BENDING — Rectangular Section — Reinforcement Distributed Equally on Two Sides



**Chart 36 COMPRESSION WITH BENDING — Rectangular Section — Reinforcement Distributed Equally on Two Sides**

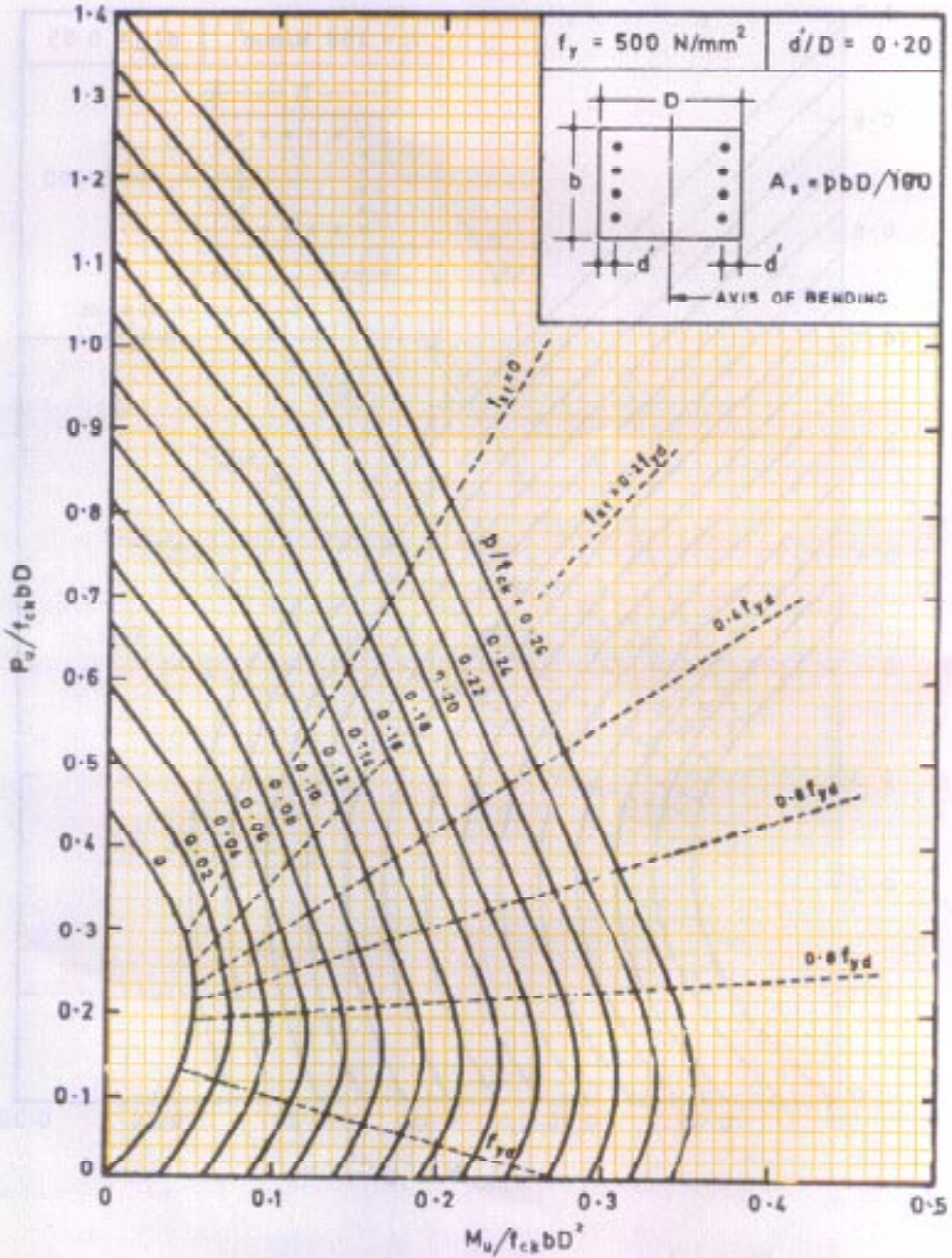


**Chart 37 COMPRESSION WITH BENDING – Rectangular Section – Reinforcement Distributed Equally on Two Sides**

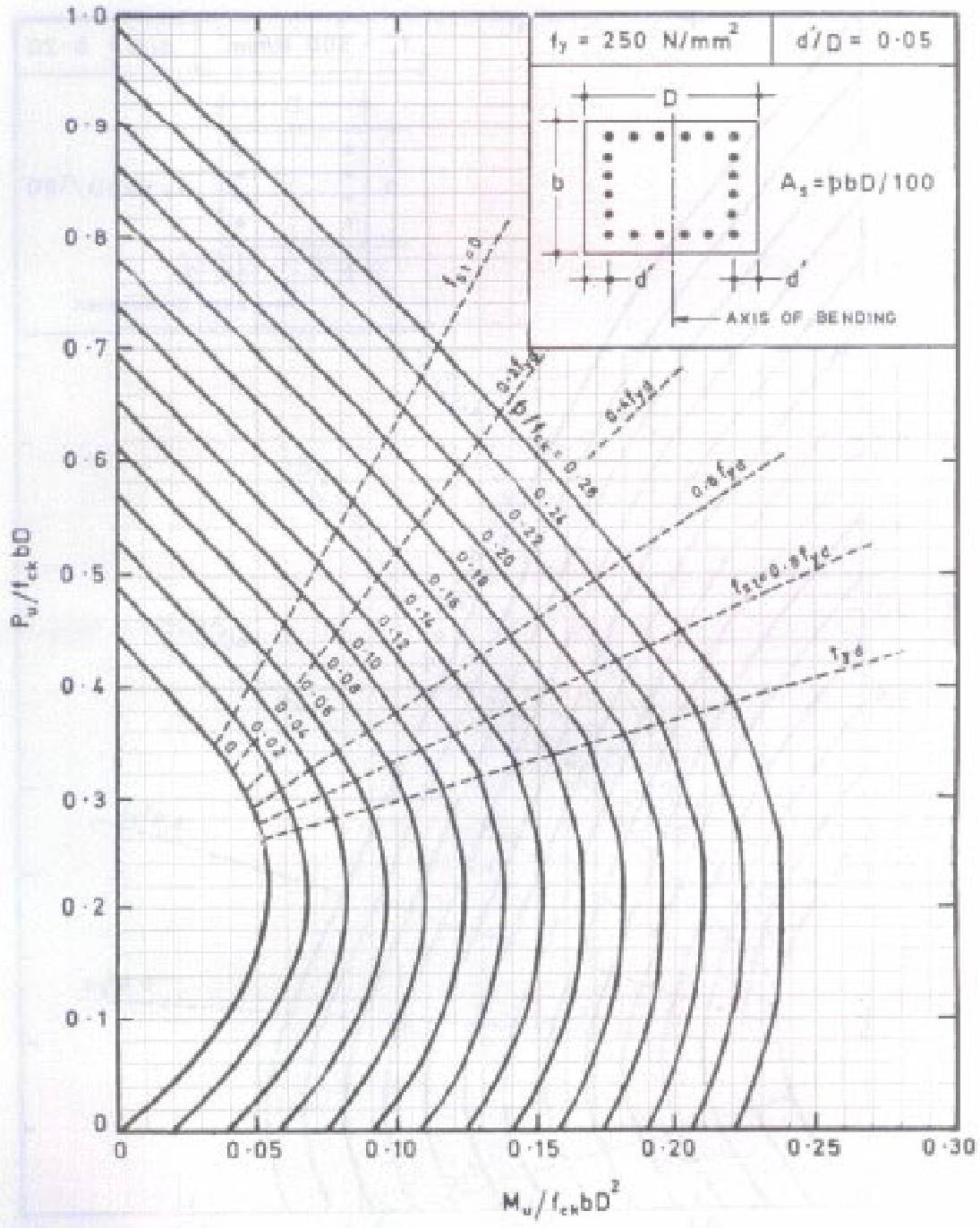




**Chart 38 COMPRESSION WITH BENDING — Rectangular Section — Reinforcement Distributed Equally on Two Sides**



**Chart 39 COMPRESSION WITH BENDING — Rectangular Section — Reinforcement Distributed Equally on Four Sides**



**Chart 40 COMPRESSION WITH BENDING—Rectangular Section—Reinforcement Distributed Equally on Four Sides**

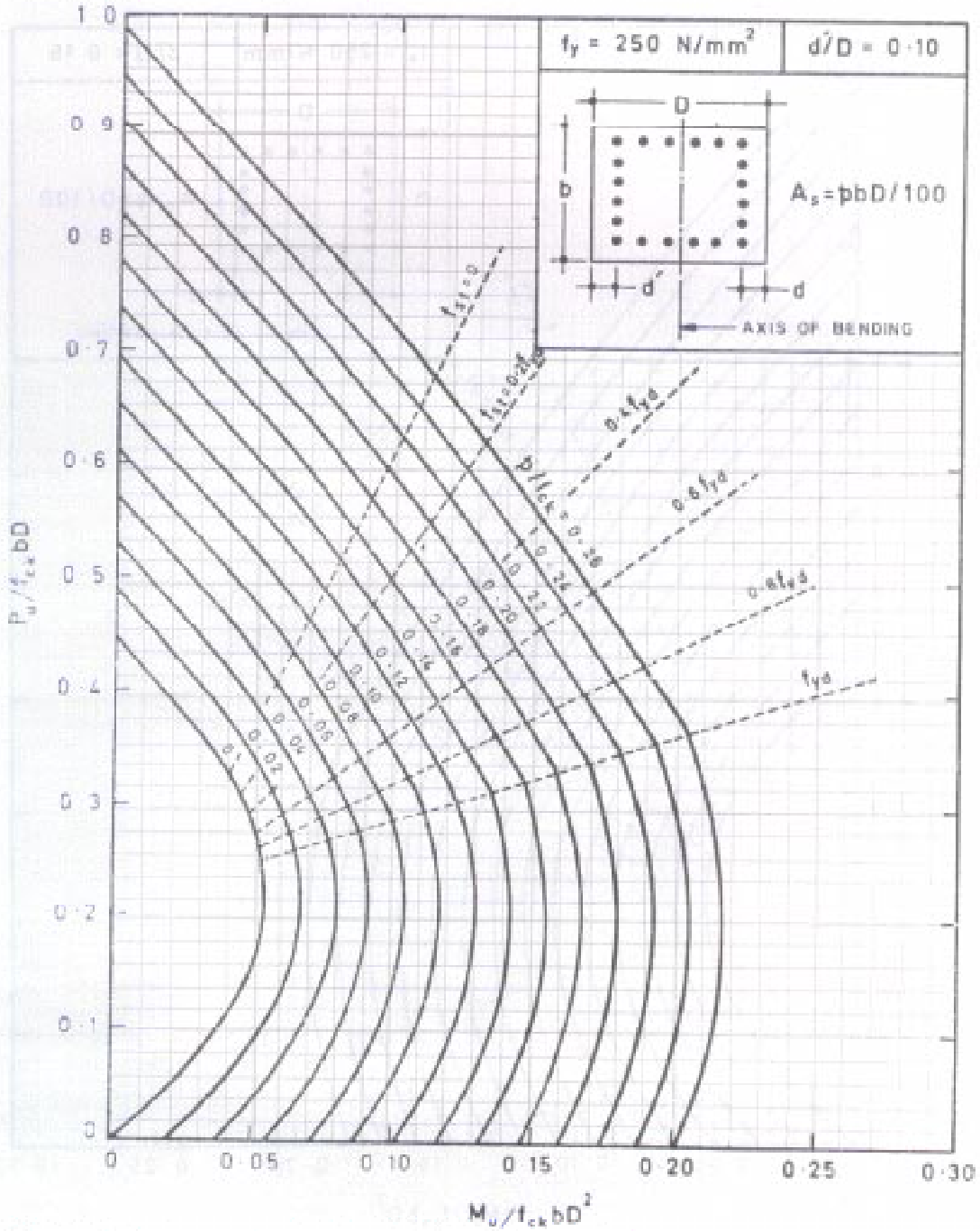




Chart 41 COMPRESSION WITH BENDING – Rectangular Section – Reinforcement Distributed Equally on Four Sides

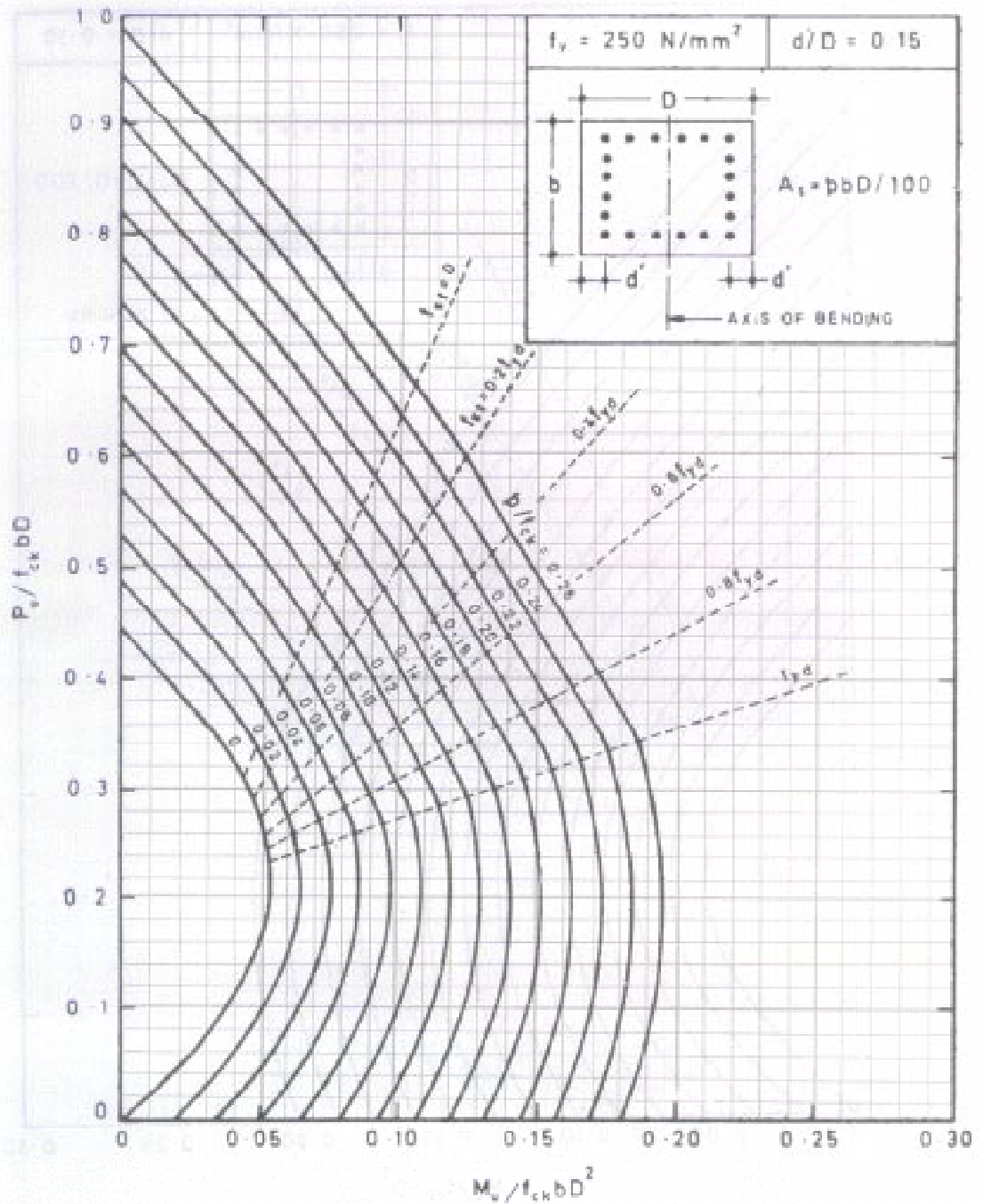
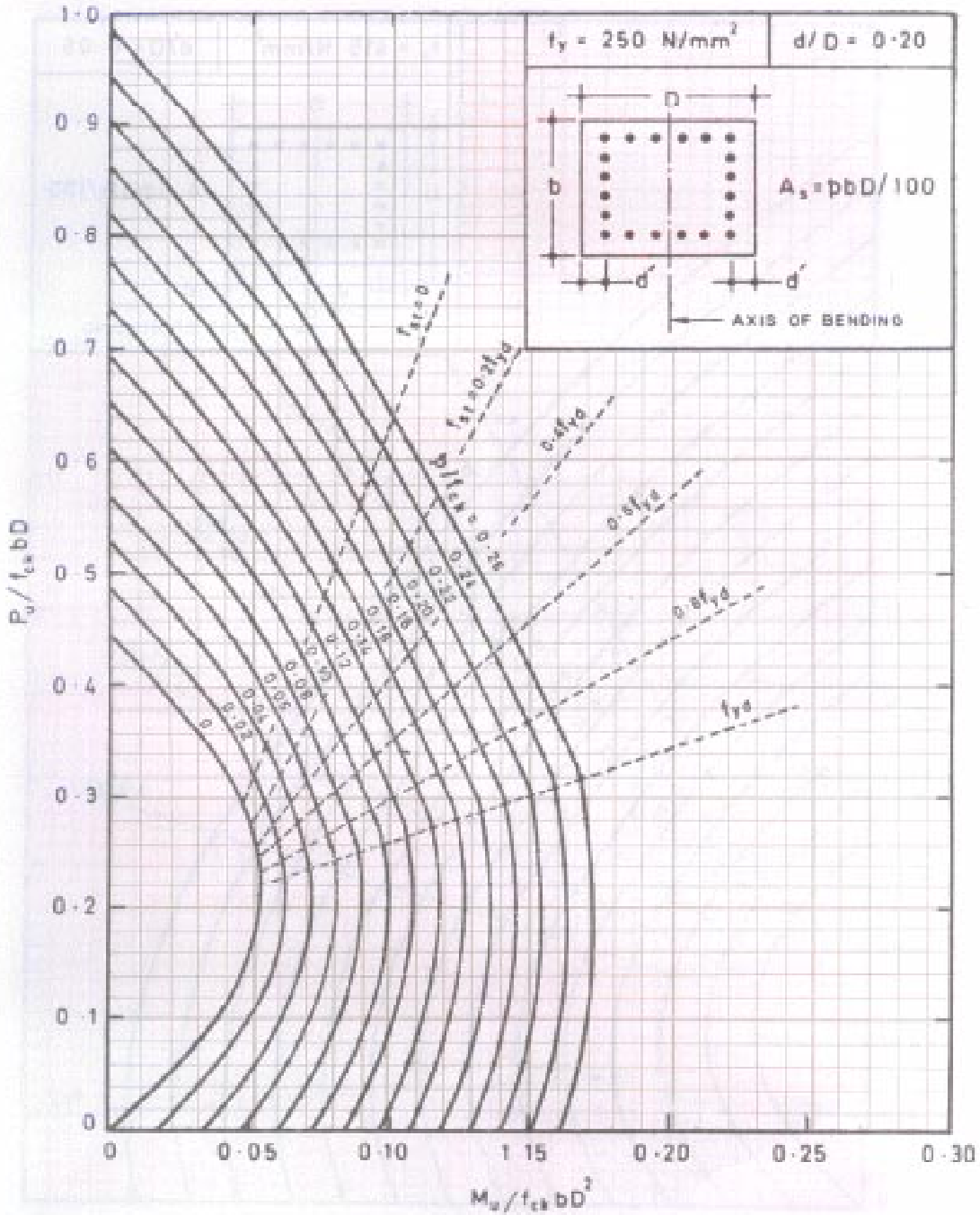
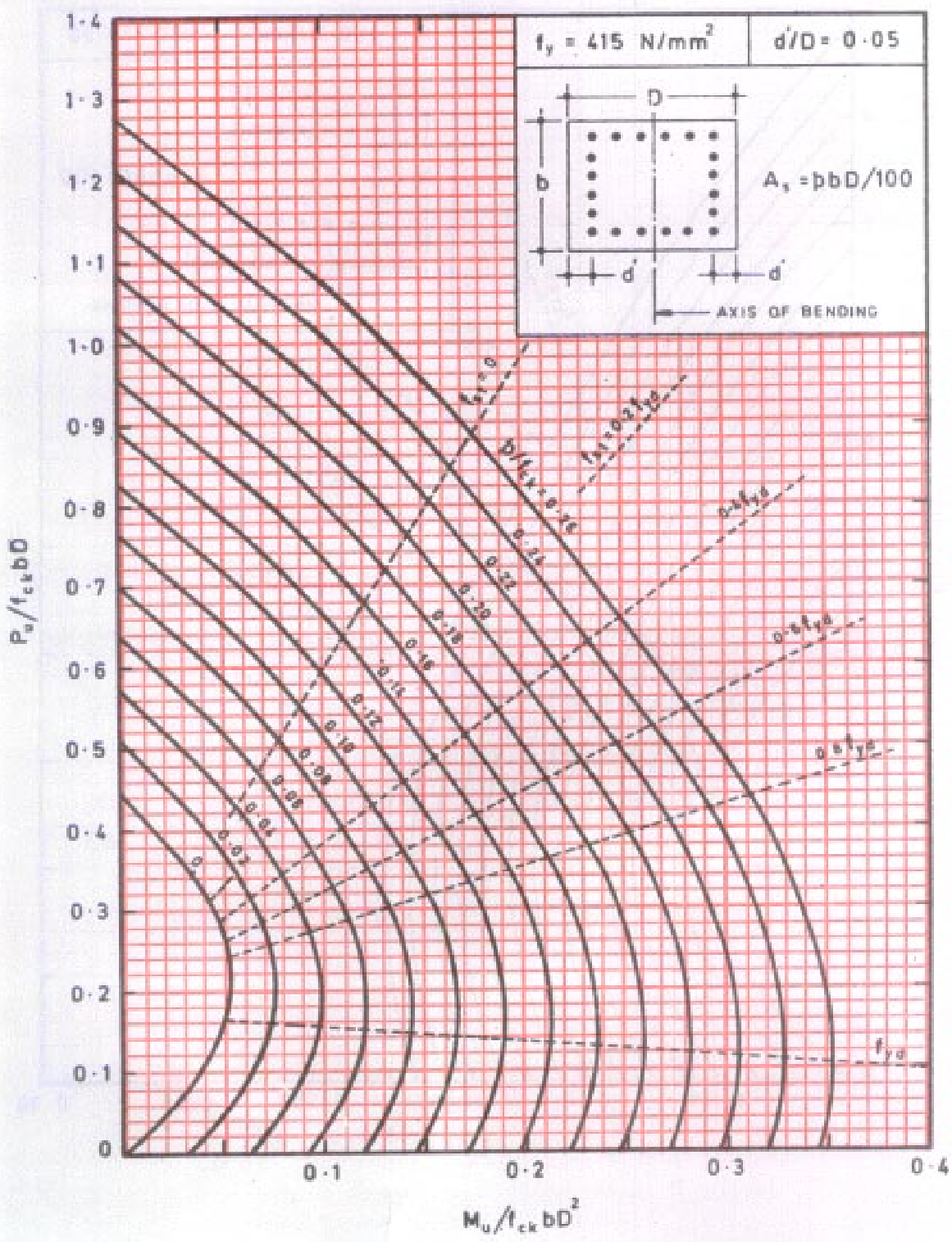


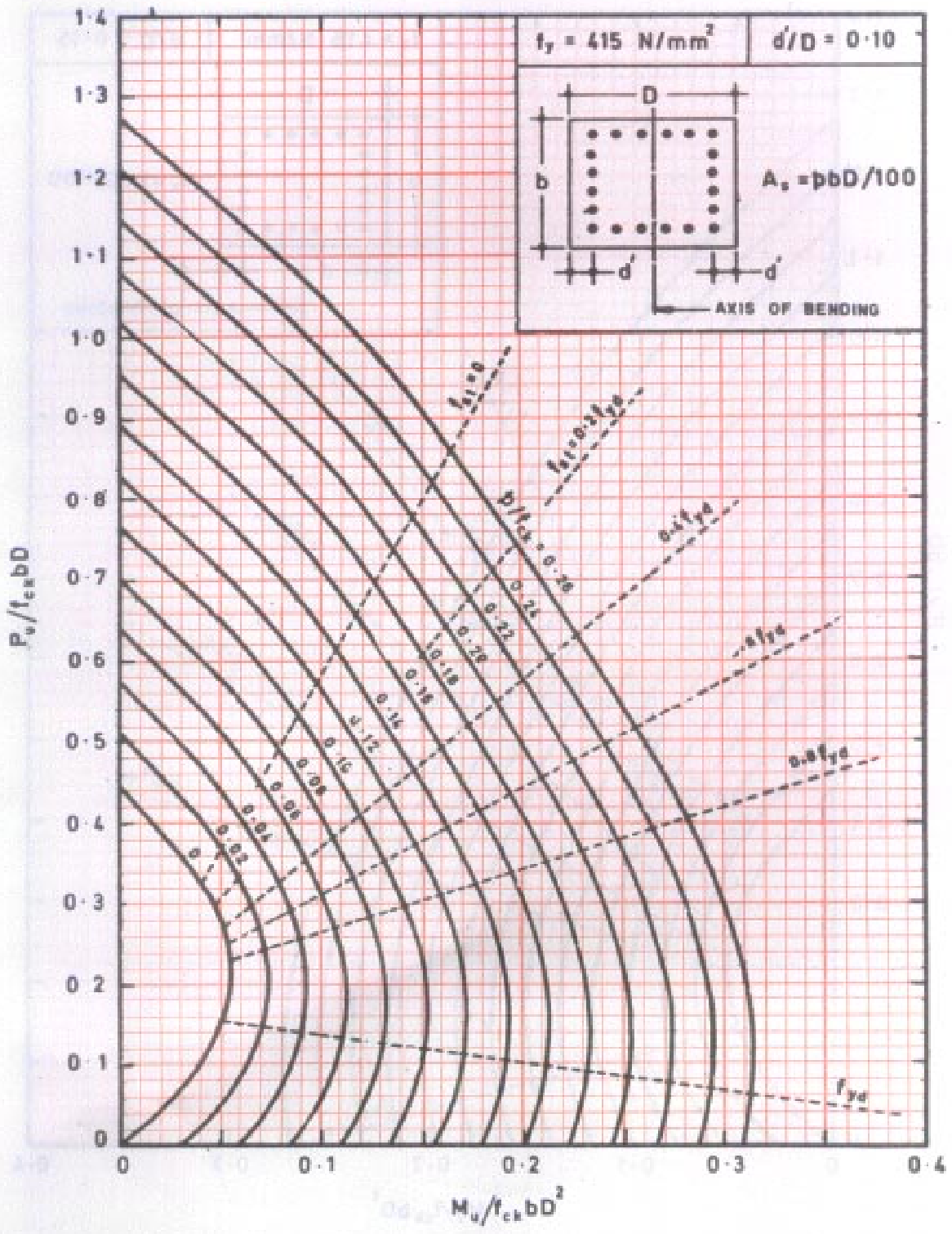
Chart 42 COMPRESSION WITH BENDING — Rectangular Section — Reinforcement Distributed Equally on Four Sides



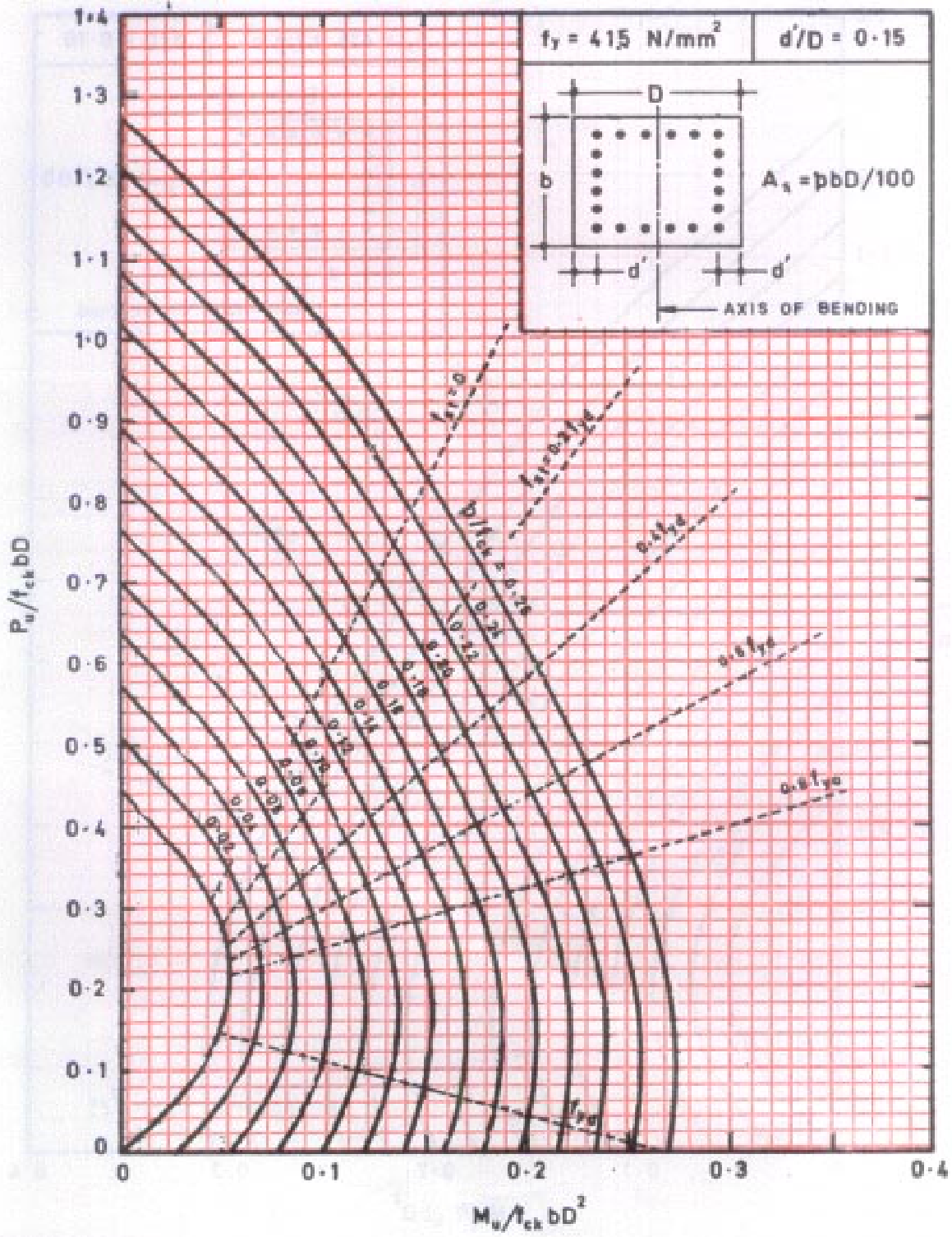
**Chart 43 COMPRESSION WITH BENDING — Rectangular Section — Reinforcement Distributed Equally on Four Sides**



**Chart 44 COMPRESSION WITH BENDING — Rectangular Section — Reinforcement Distributed Equally on Four Sides**

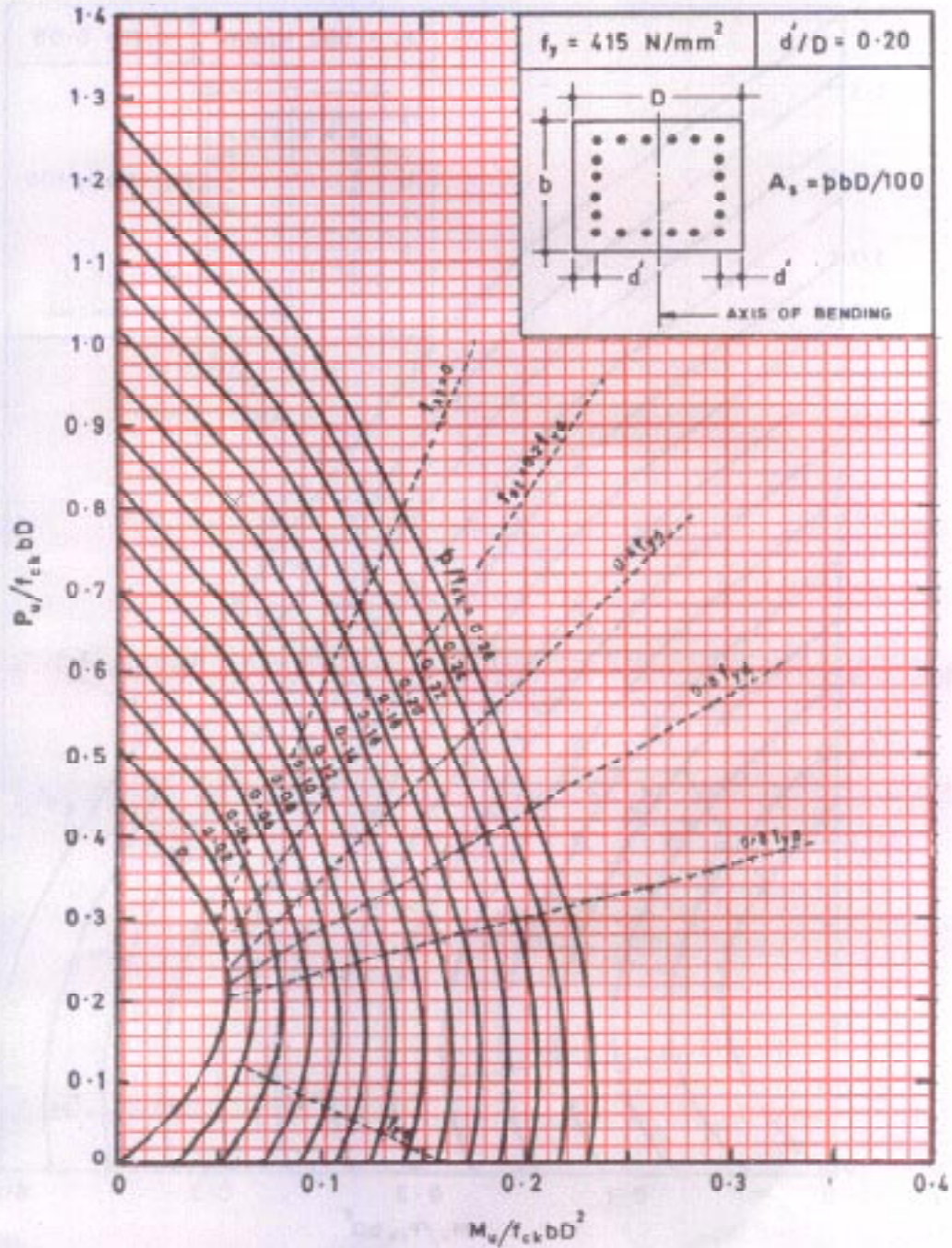


**Chart 45 COMPRESSION WITH BENDING — Rectangular Section — Reinforcement Distributed Equally on Four Sides**



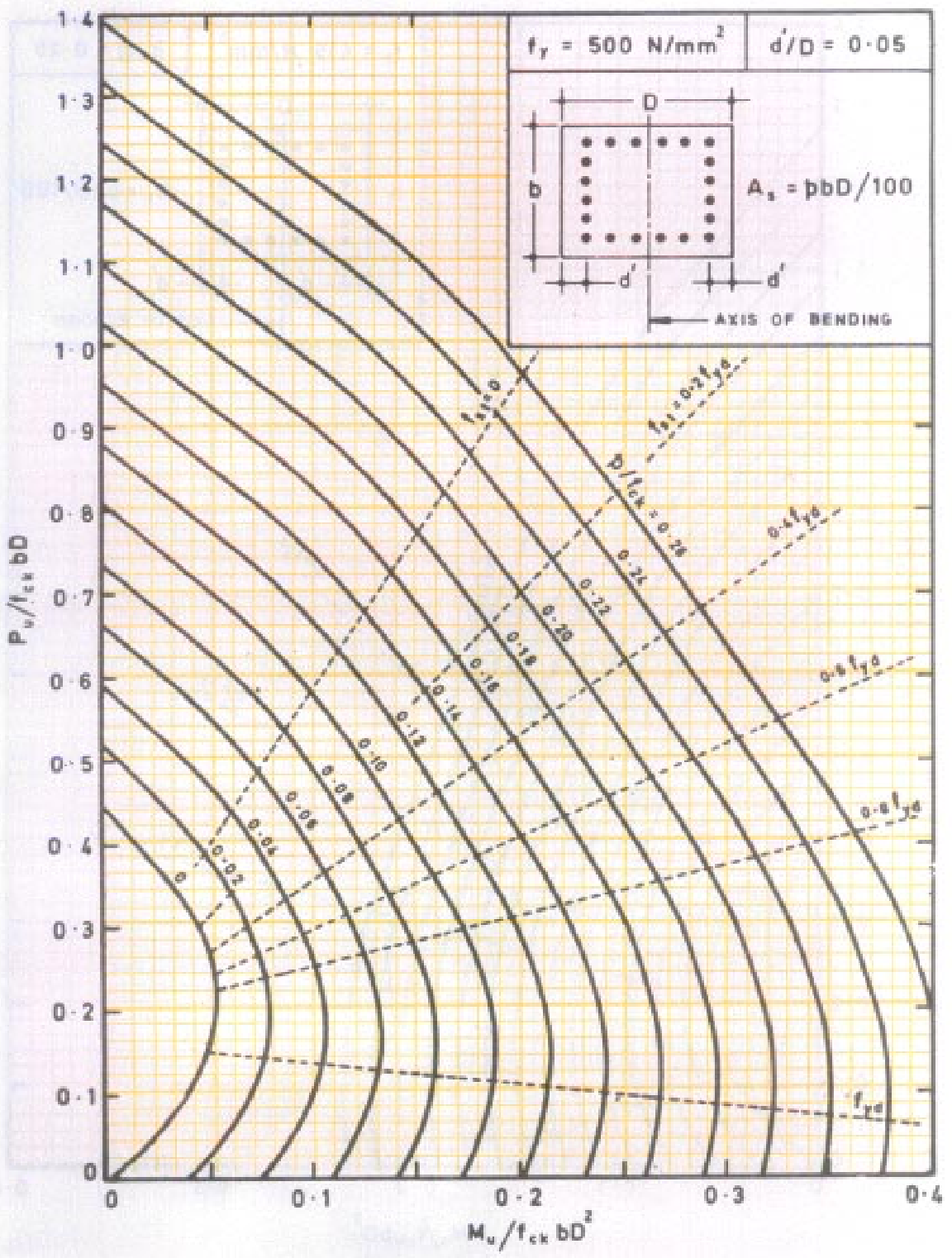


**Chart 46 COMPRESSION WITH BENDING—Rectangular Section—Reinforcement Distributed Equally on Four Sides**

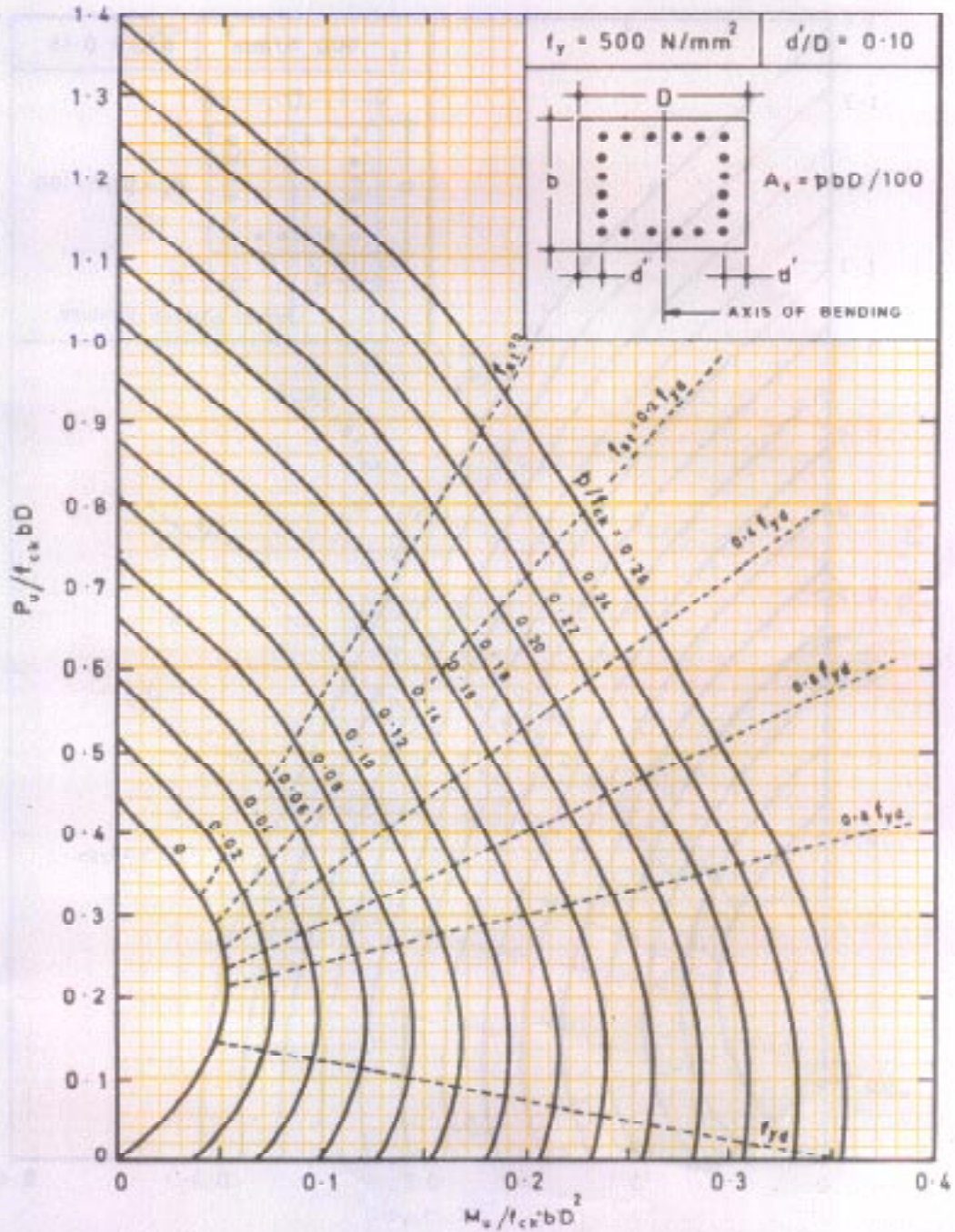




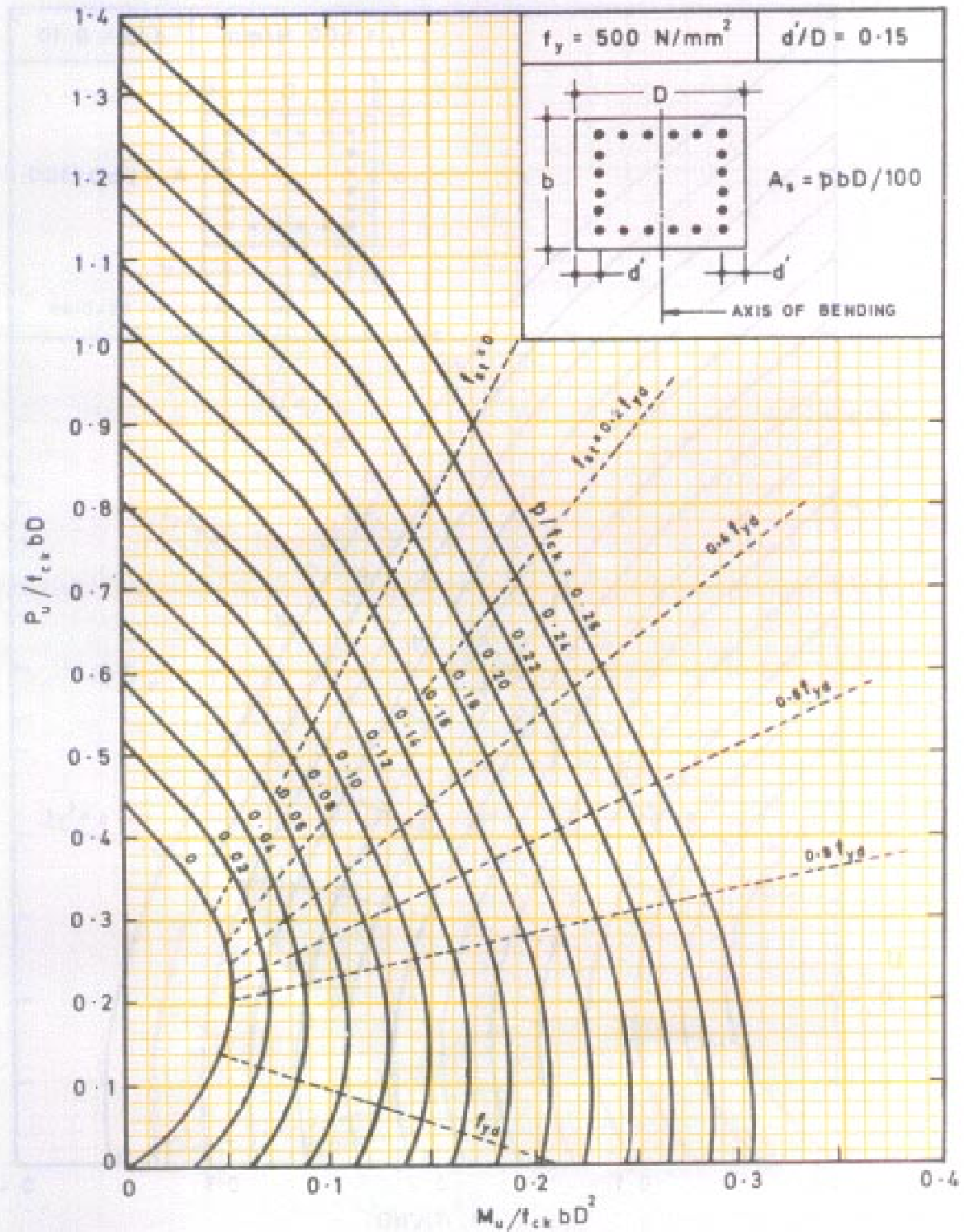
**Chart 47 COMPRESSION WITH BENDING — Rectangular Section — Reinforcement Distributed Equally on Four Sides**



**Chart 48 COMPRESSION WITH BENDING — Rectangular Section — Reinforcement Distributed Equally on Four Sides**

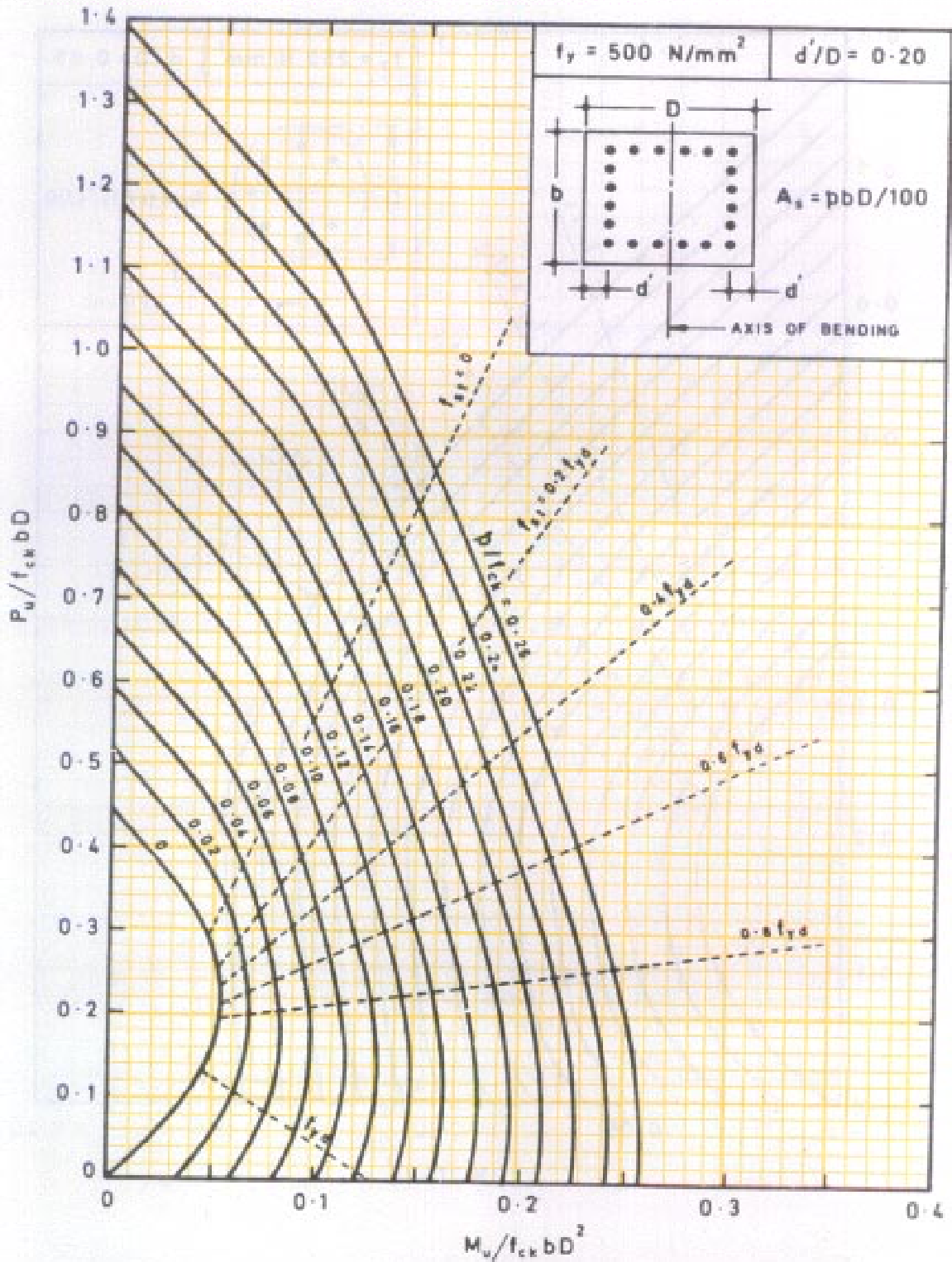


**Chart 49 COMPRESSION WITH BENDING — Rectangular Section — Reinforcement Distributed Equally on Four Sides**





**Chart 50 COMPRESSION WITH BENDING — Rectangular Section — Reinforcement Distributed Equally on Four Sides**



**Chart 51 COMPRESSION WITH BENDING – Circular Section**

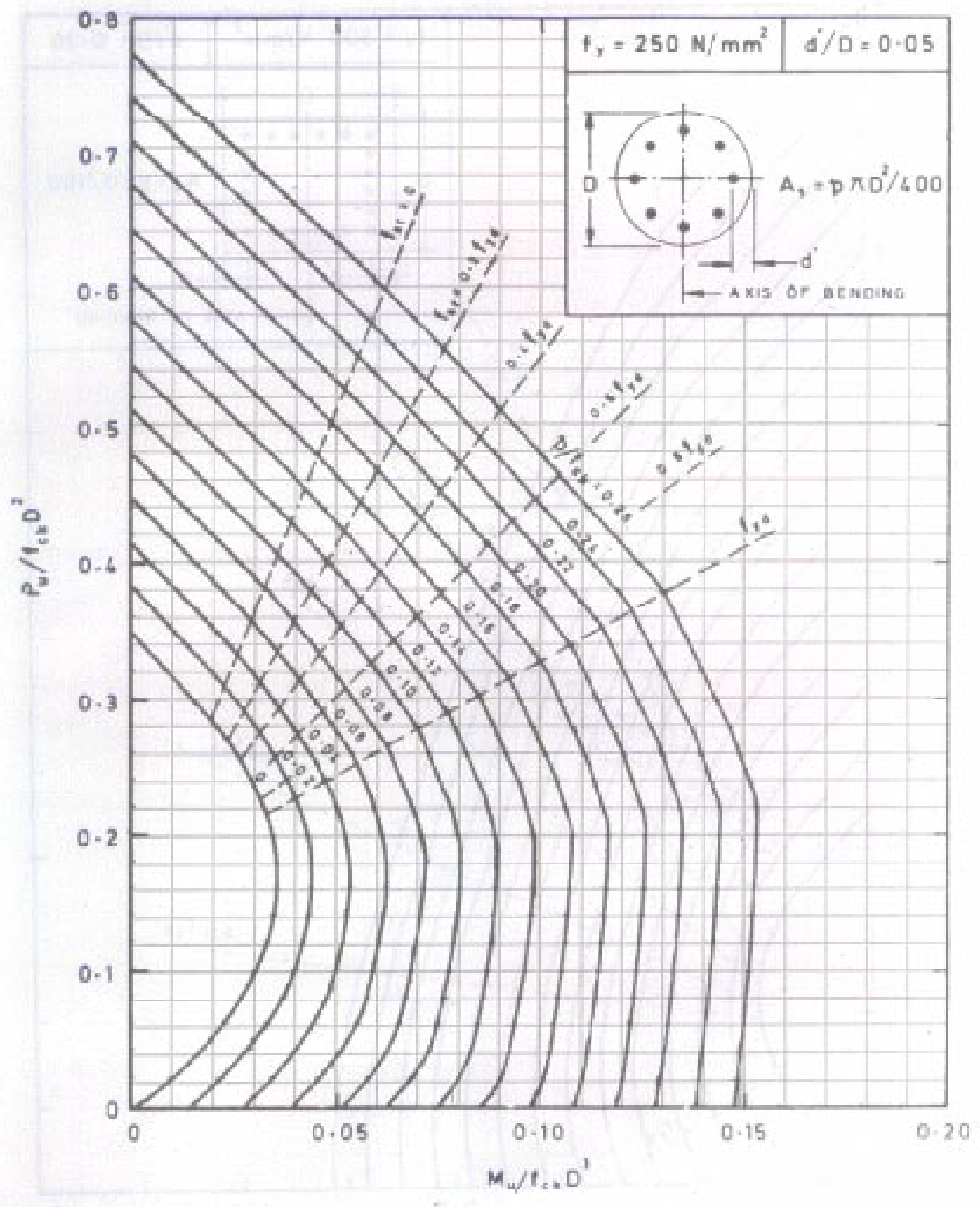


Chart 52 COMPRESSION WITH BENDING – Circular Section

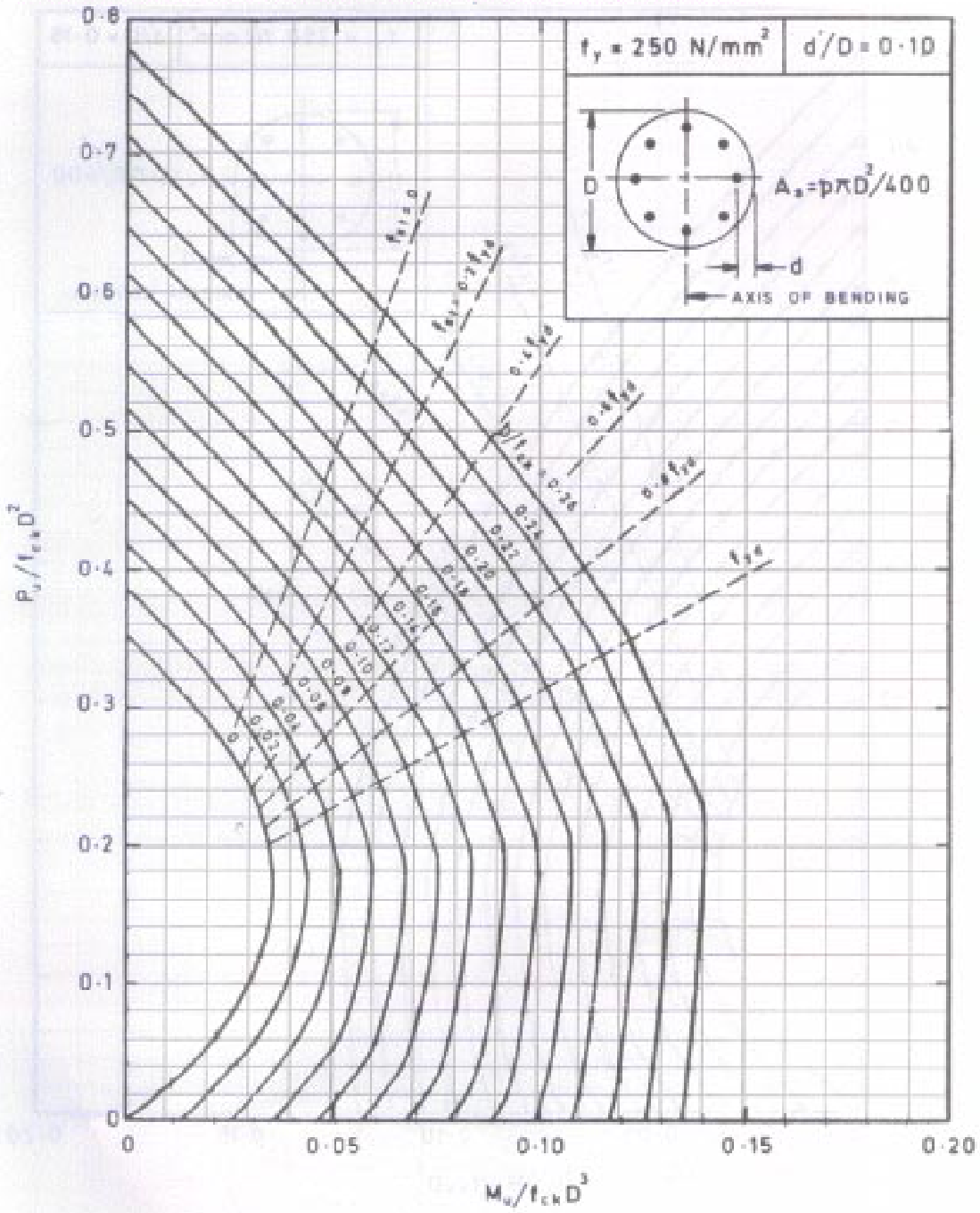




Chart 53 COMPRESSION WITH BENDING — Circular Section

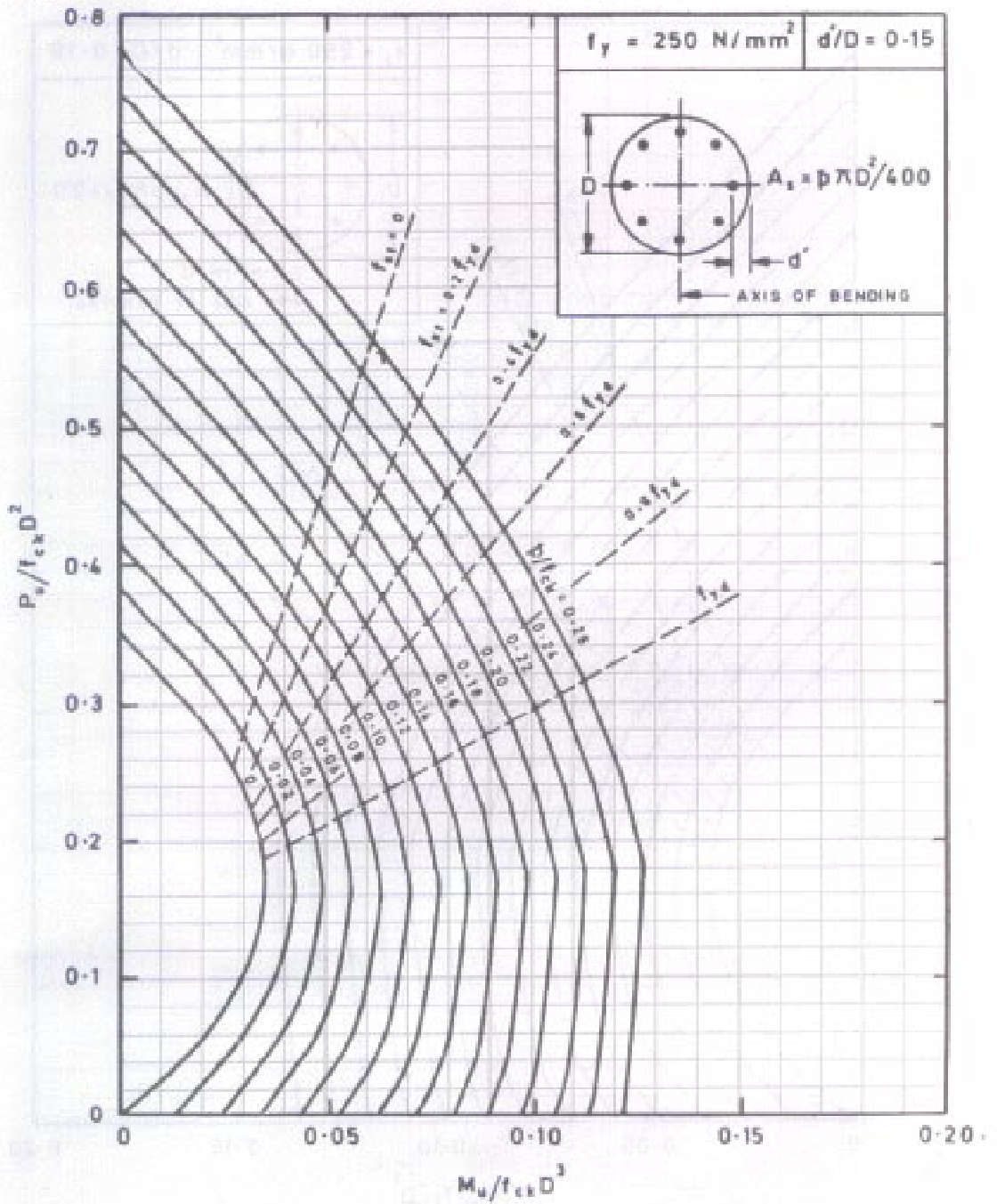


Chart 54 COMPRESSION WITH BENDING — Circular Section

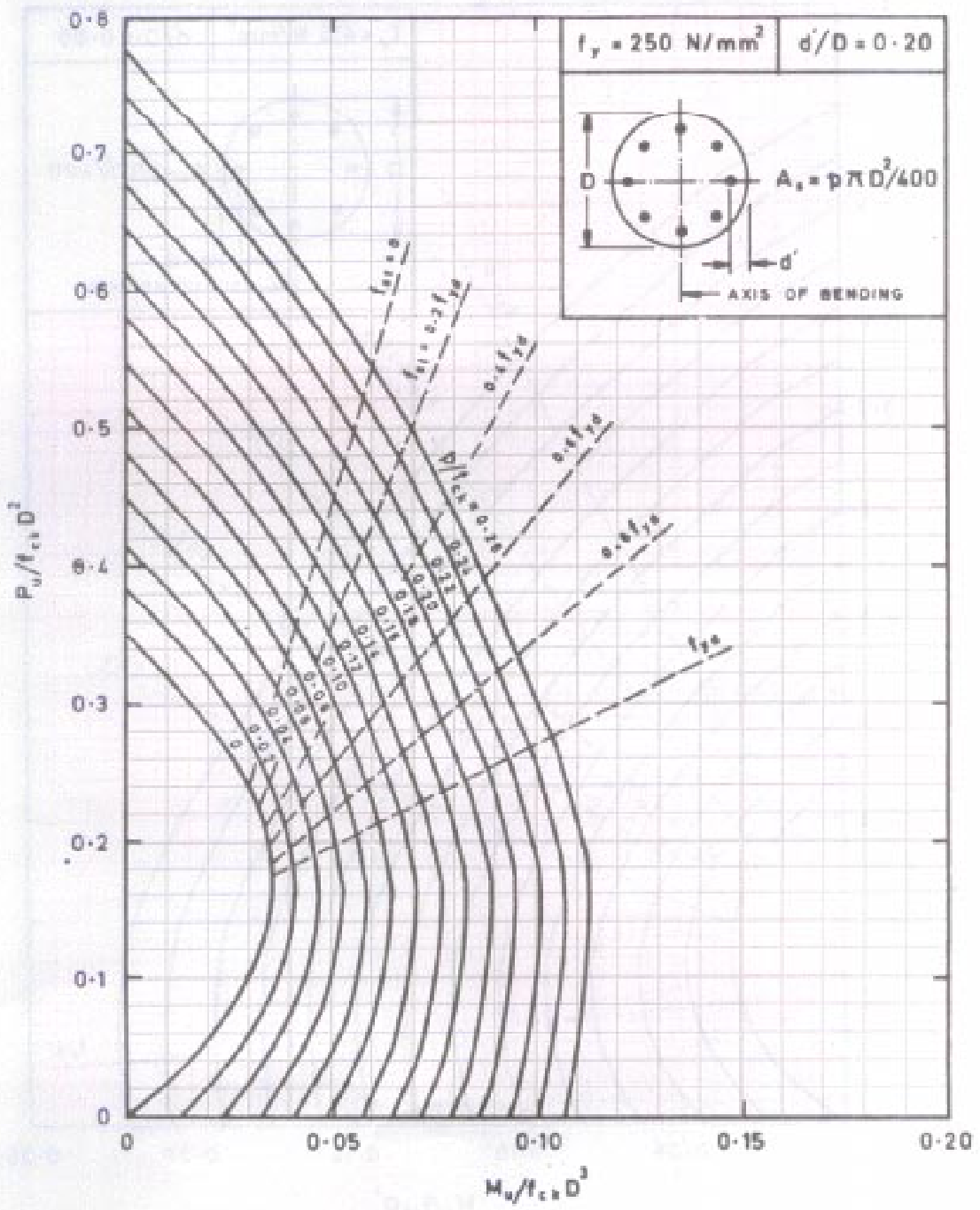
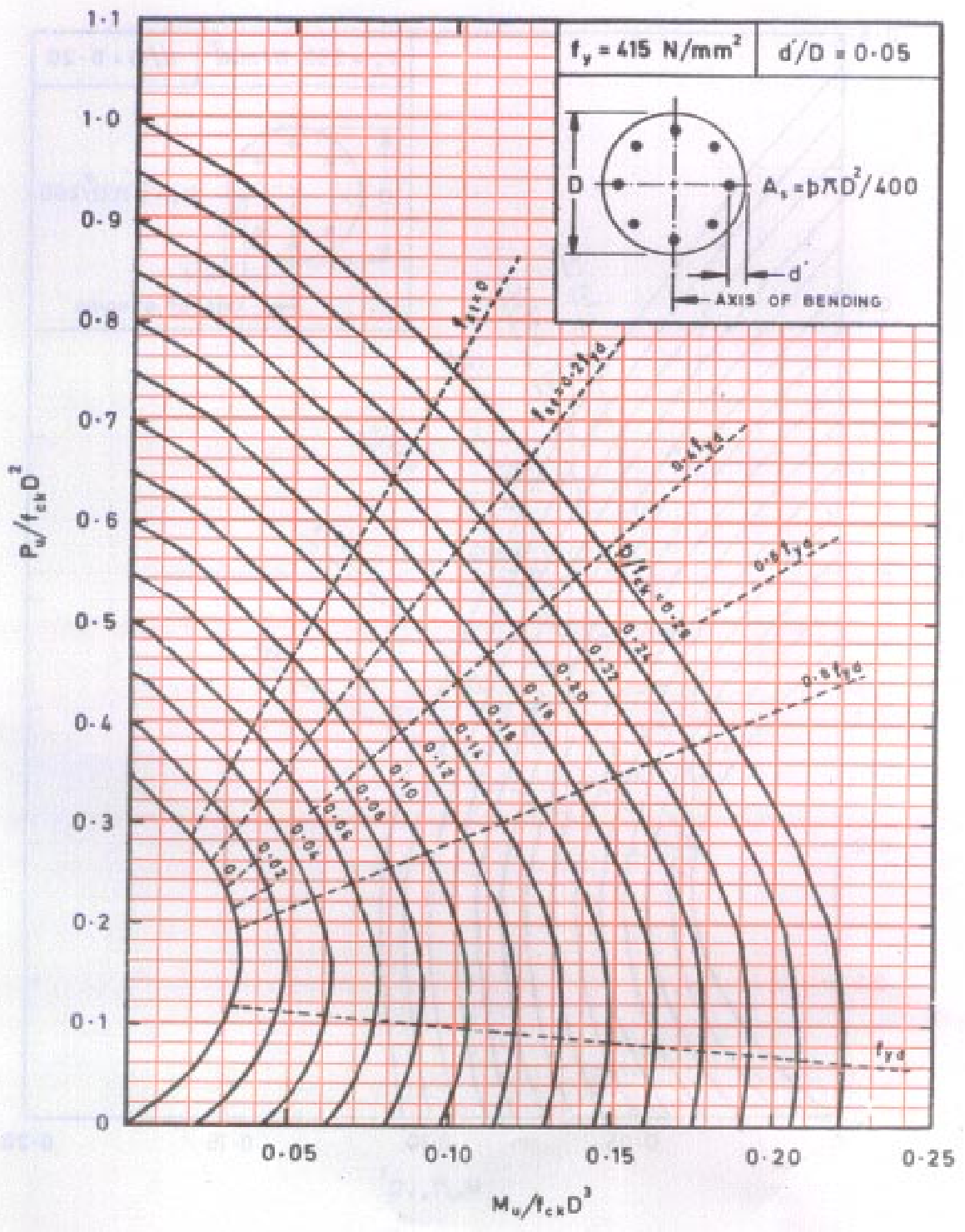


Chart 55 COMPRESSION WITH BENDING – Circular Section





**Chart 56 COMPRESSION WITH BENDING — Circular Section**

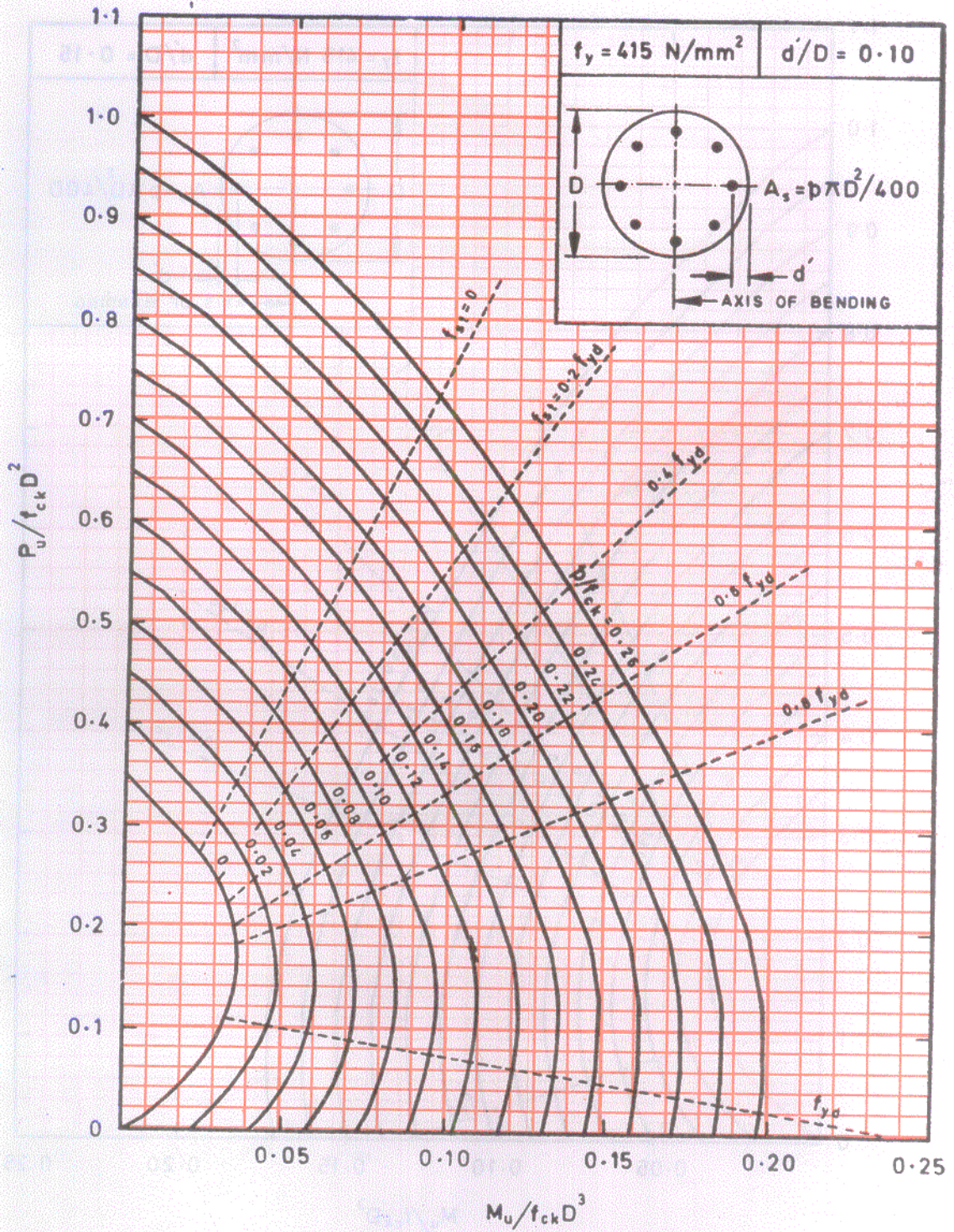




Chart 57 COMPRESSION WITH BENDING — Circular Section

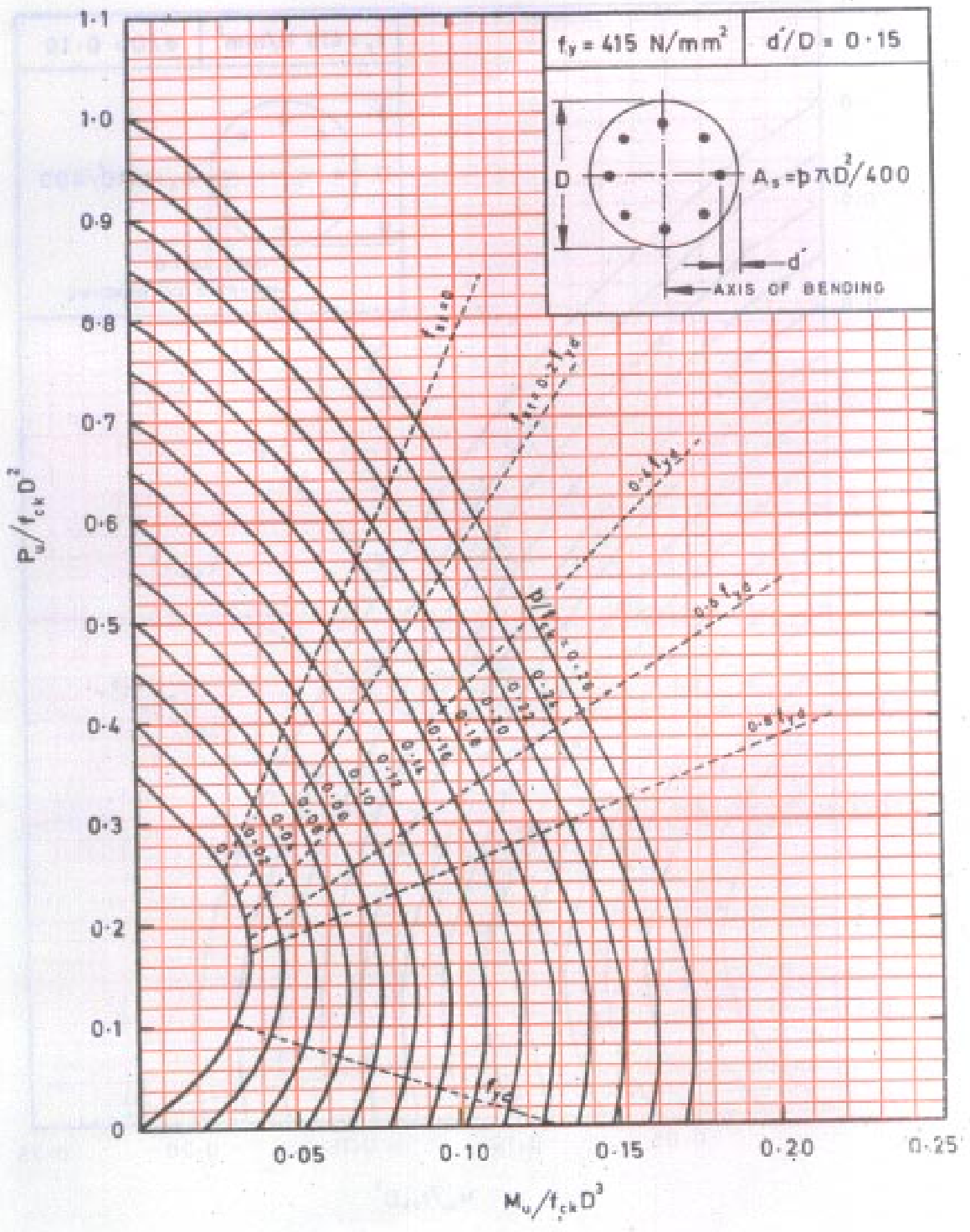


Chart 58 COMPRESSION WITH BENDING — Circular Section

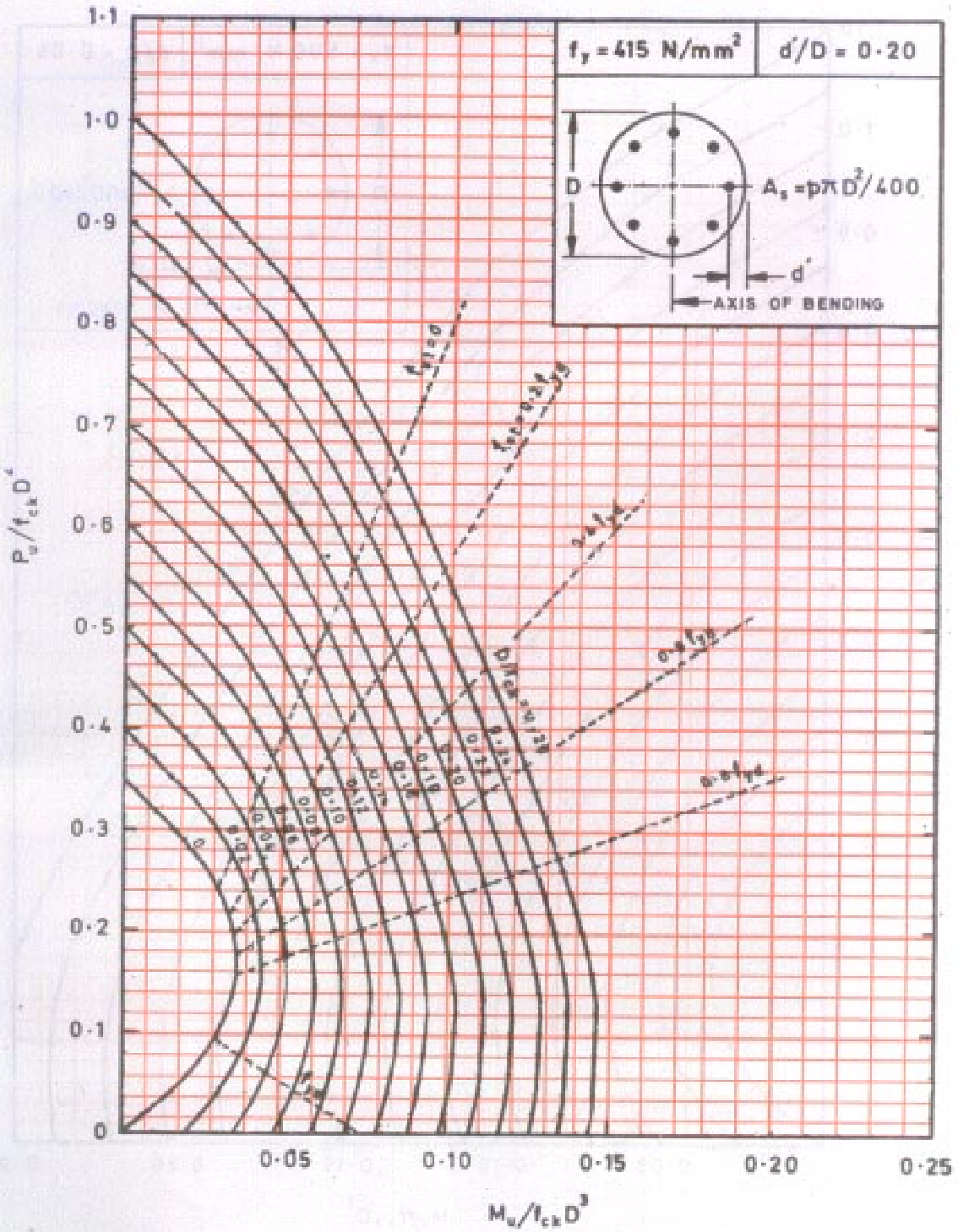




Chart 59 COMPRESSION WITH BENDING – Circular Section

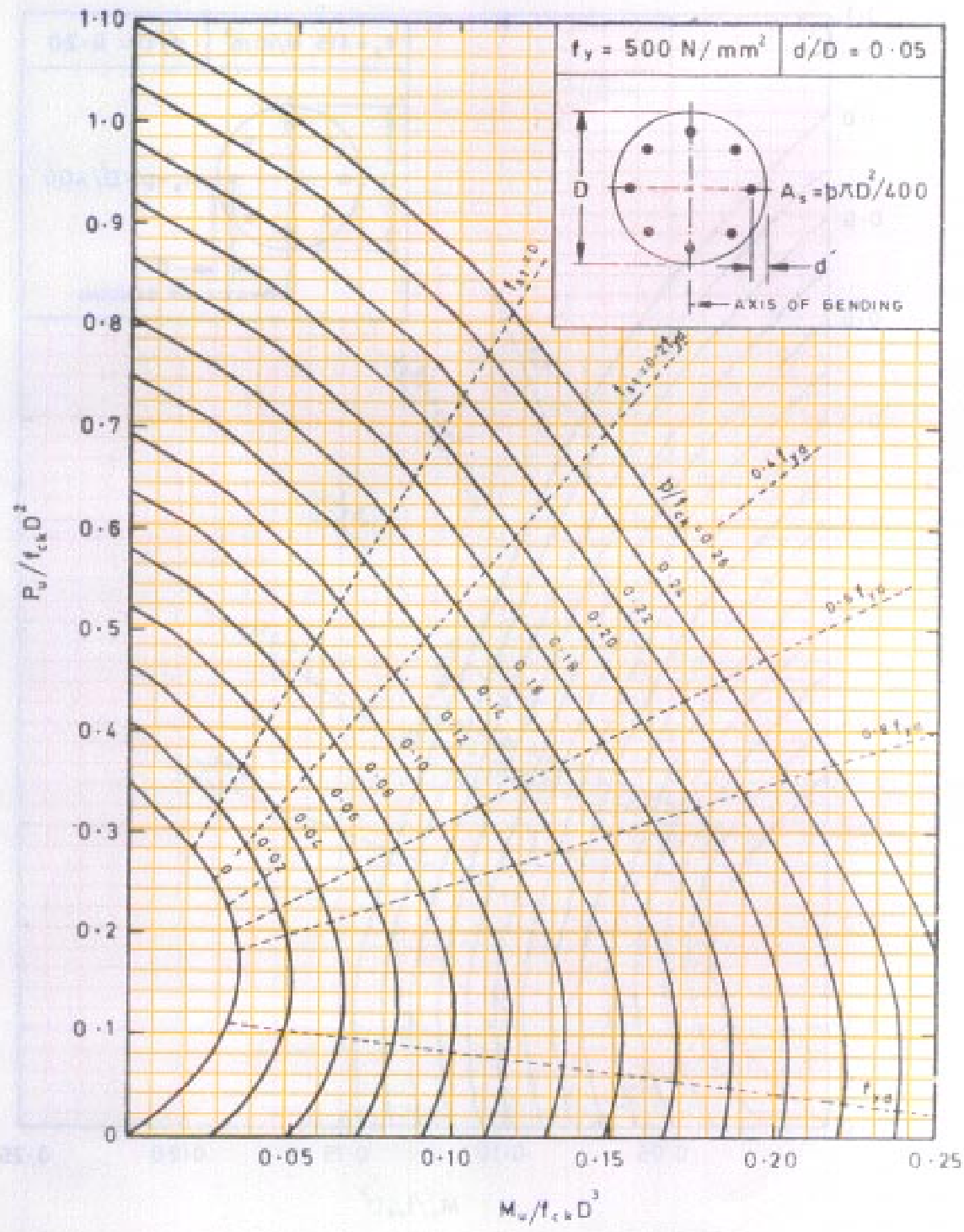


Chart 60 COMPRESSION WITH BENDING — Circular Section

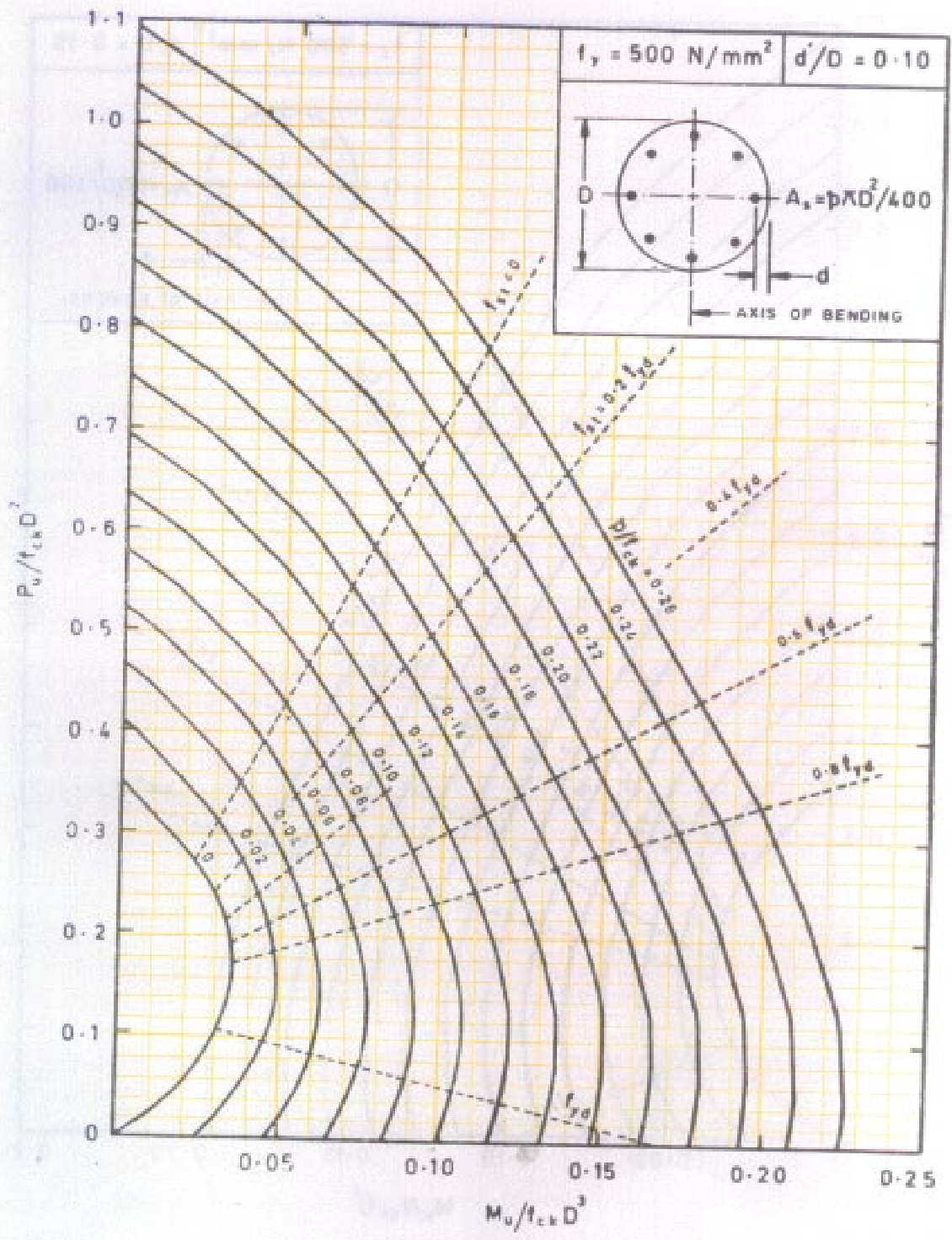


Chart 61 COMPRESSION WITH BENDING – Circular Section

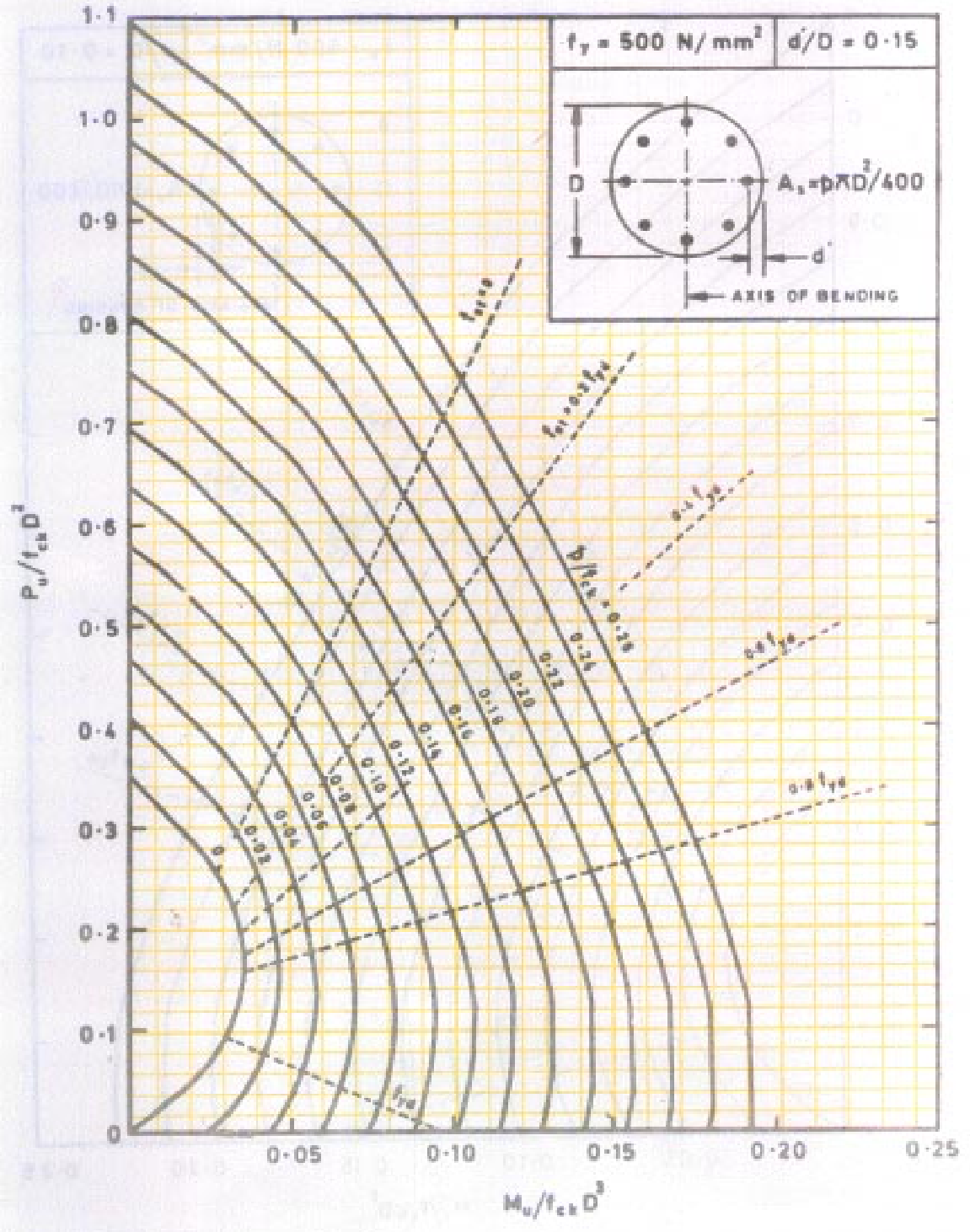
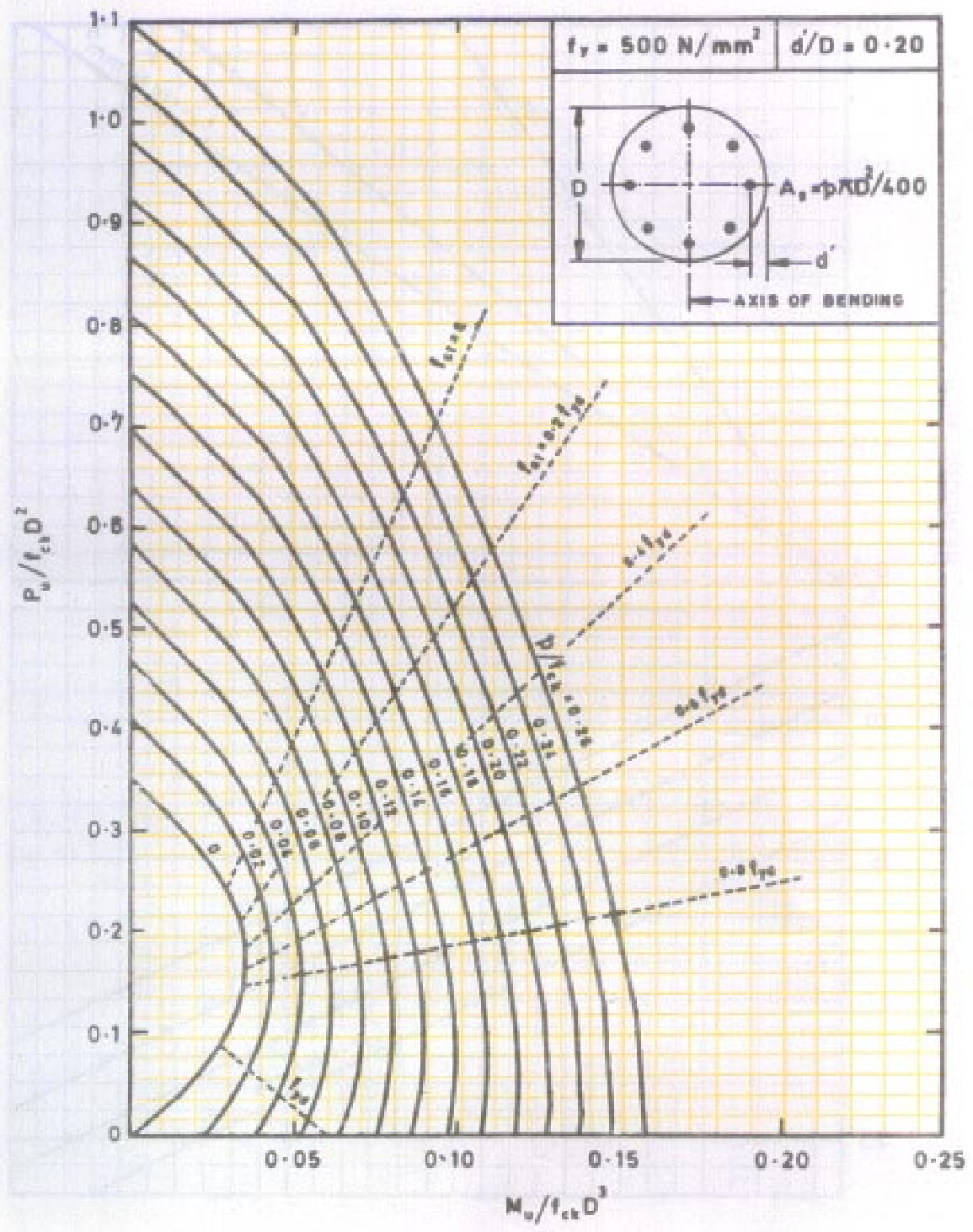


Chart 62 COMPRESSION WITH BENDING — Circular Section



$f_y$
250
415
500
$f_{ck}$
15
20
25
30

Chart 63 VALUES OF  $P_{uz}$  for COMPRESSION MEMBERS

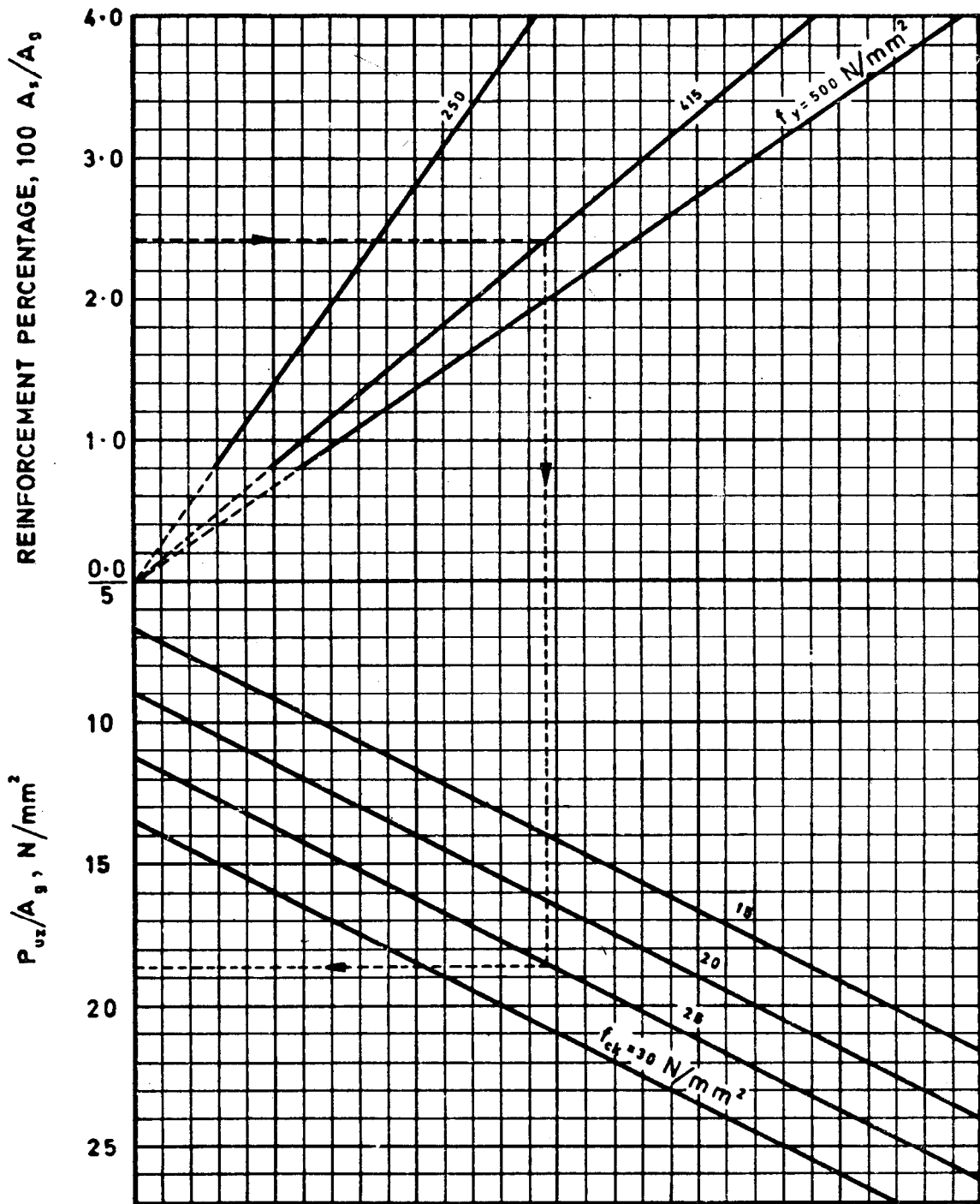
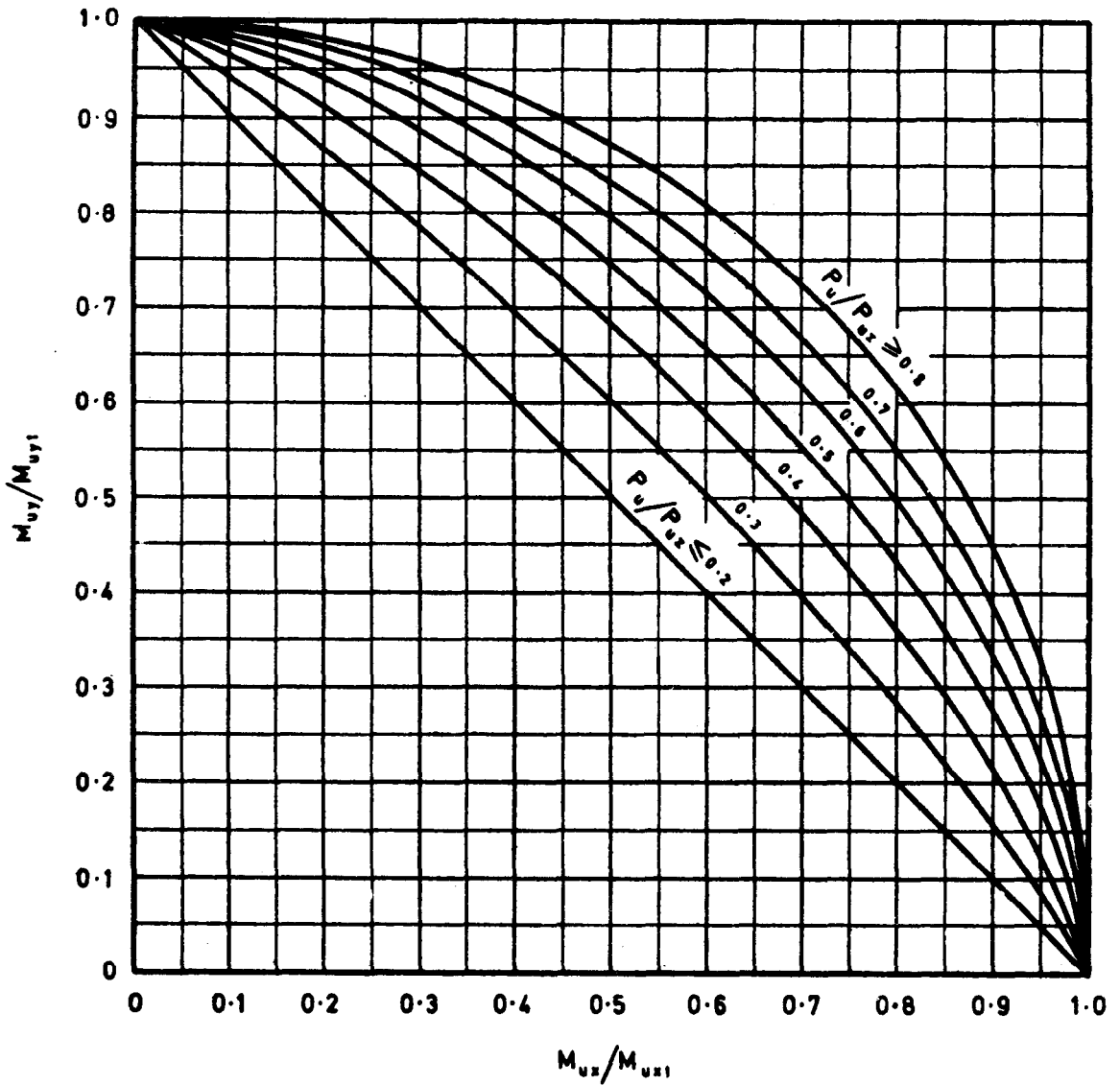


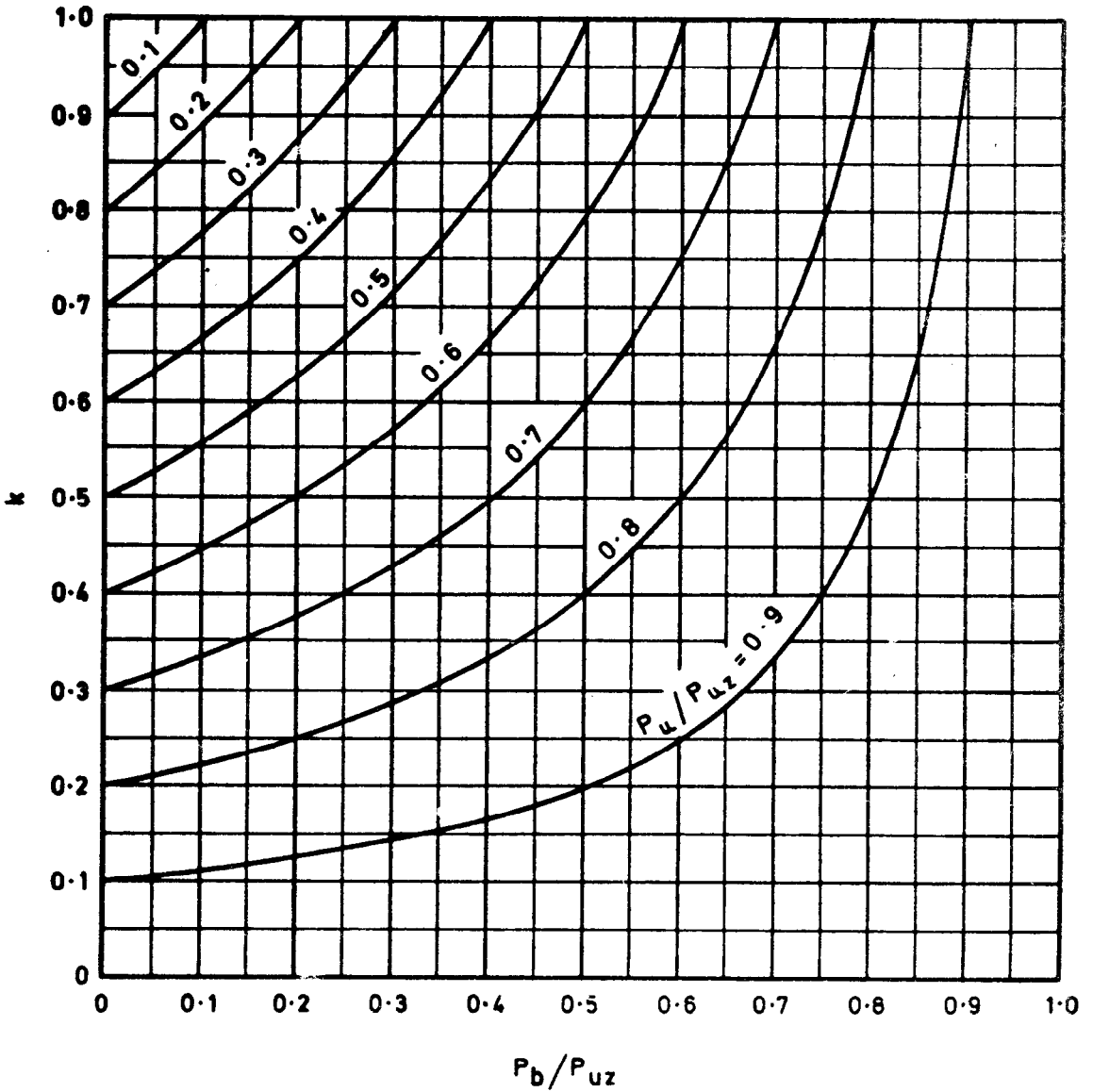
Chart 64 BIAxIAL BENDING IN COMPRESSION MEMBERS





**Chart 65 SLENDER COMPRESSION MEMBERS —  
 Multiplying Factor  $k$  for Additional Moments**

$$k = \frac{P_{uz} - P_u}{P_{uz} - P_b}$$



**Chart 66 TENSION WITH BENDING — Rectangular Section — Reinforcement Distributed Equally on Two Sides**

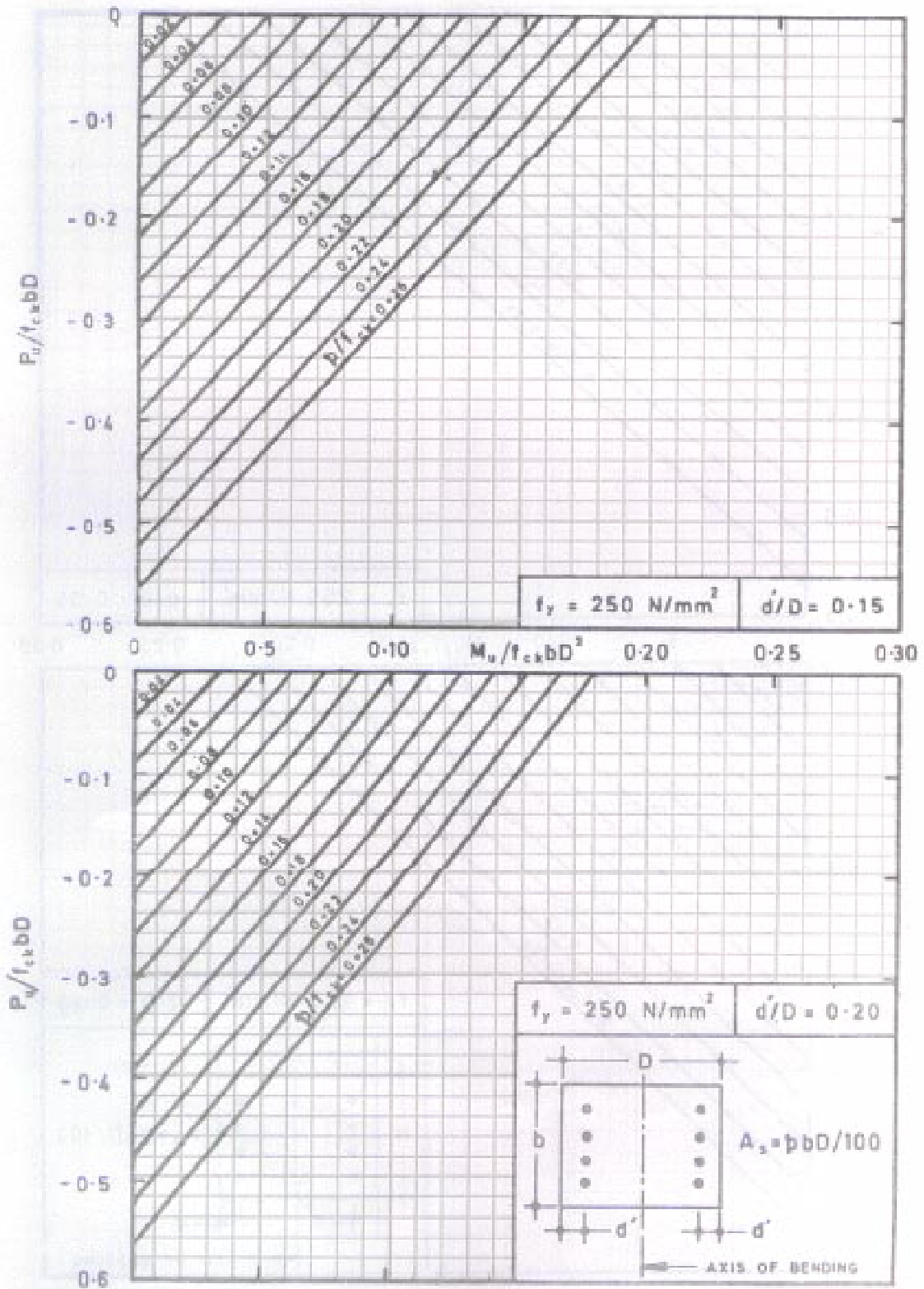
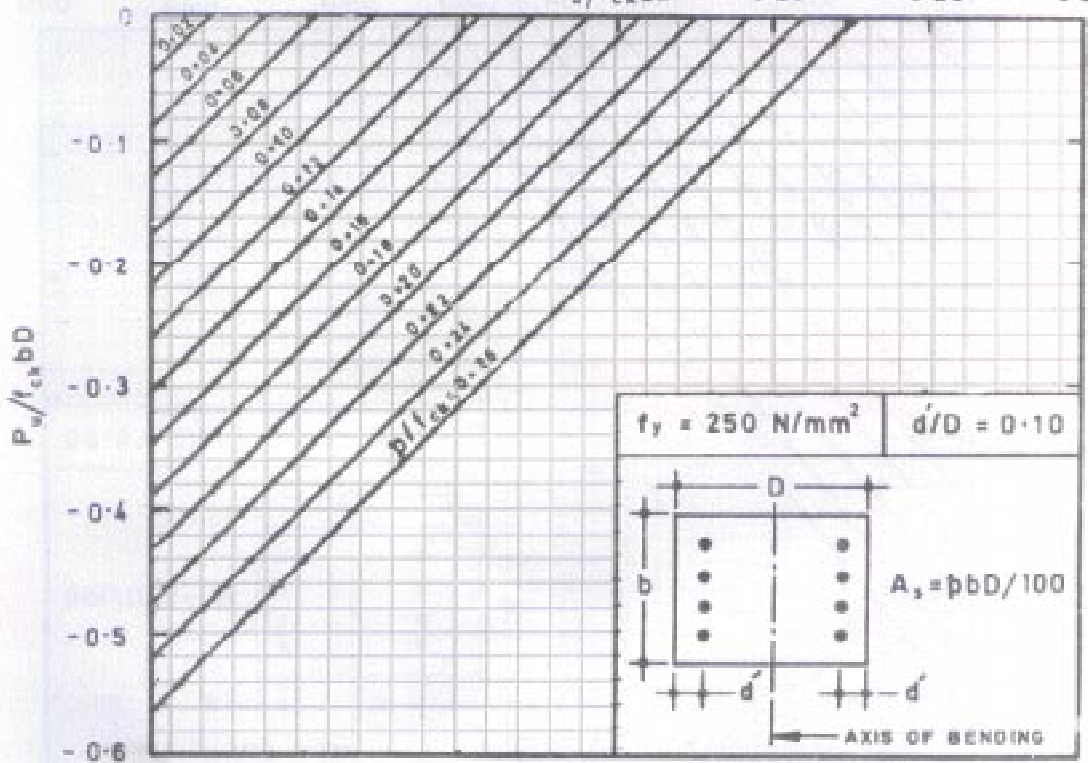
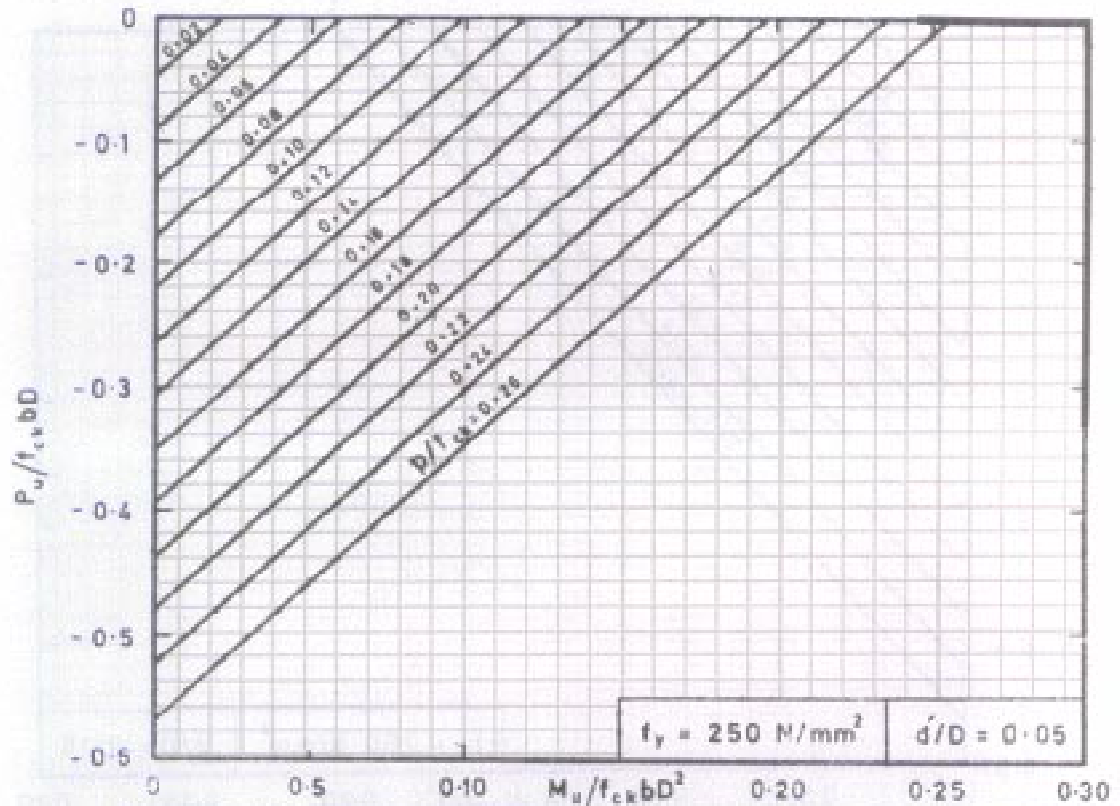


Chart 67 TENSION WITH BENDING — Rectangular Section — Reinforcement Distributed Equally on Two Sides



**Chart 68 TENSION WITH BENDING — Rectangular Section — Reinforcement Distributed Equally on Two Sides**

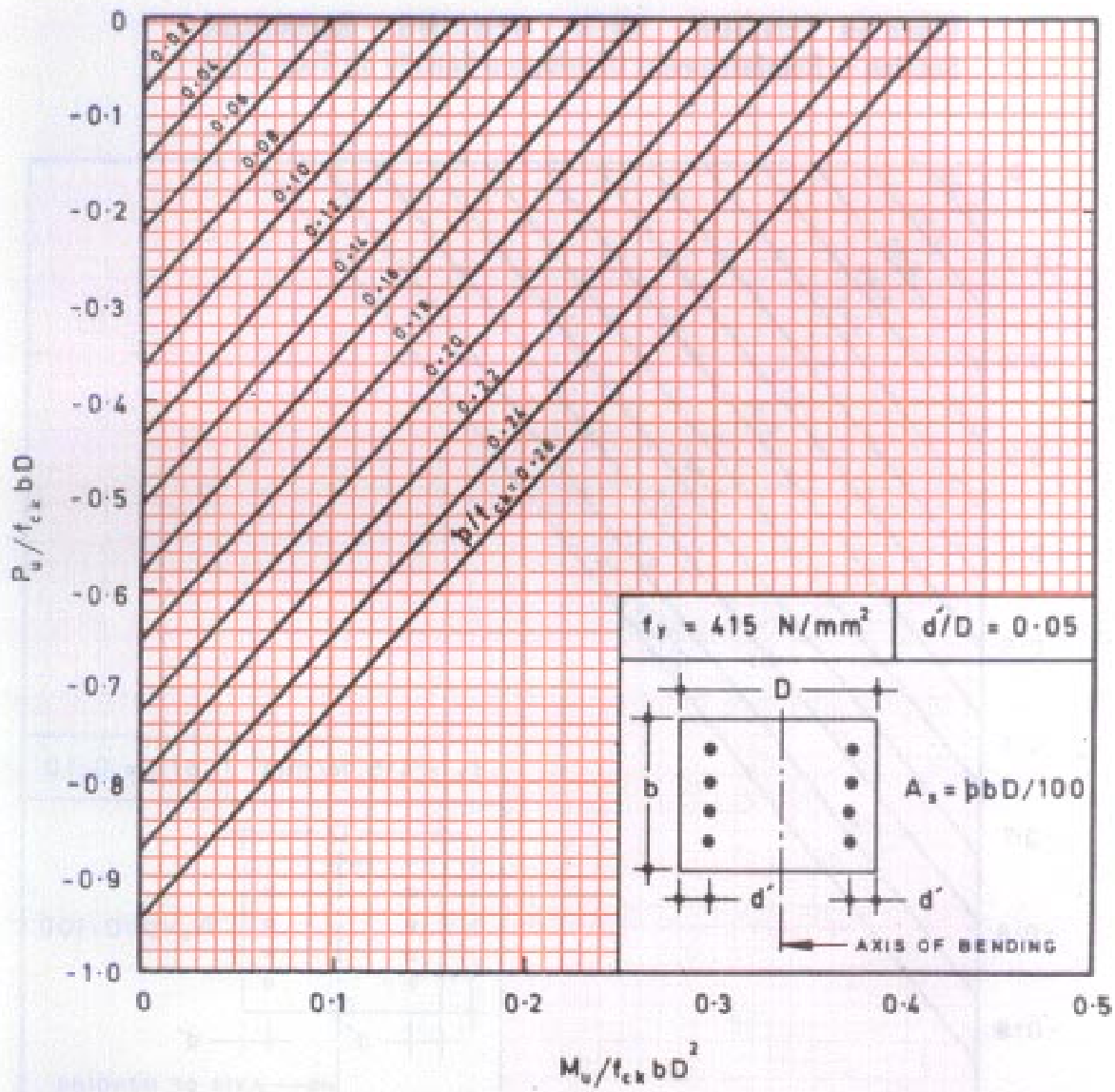


Chart 69 TENSION WITH BENDING - Reinforcement

**Chart 69 TENSION WITH BENDING — Rectangular Section — Reinforcement Distributed Equally on Two Sides**

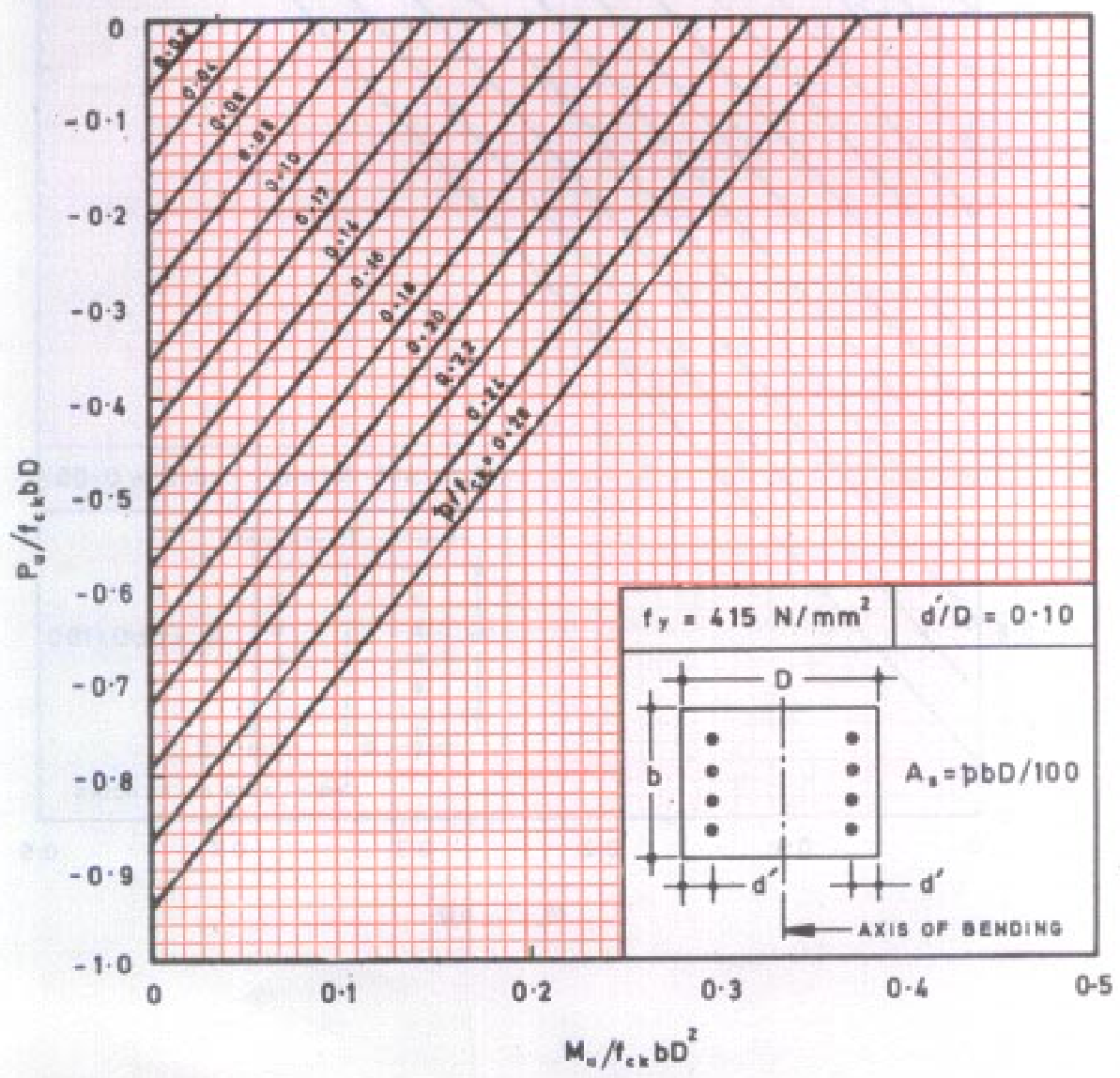
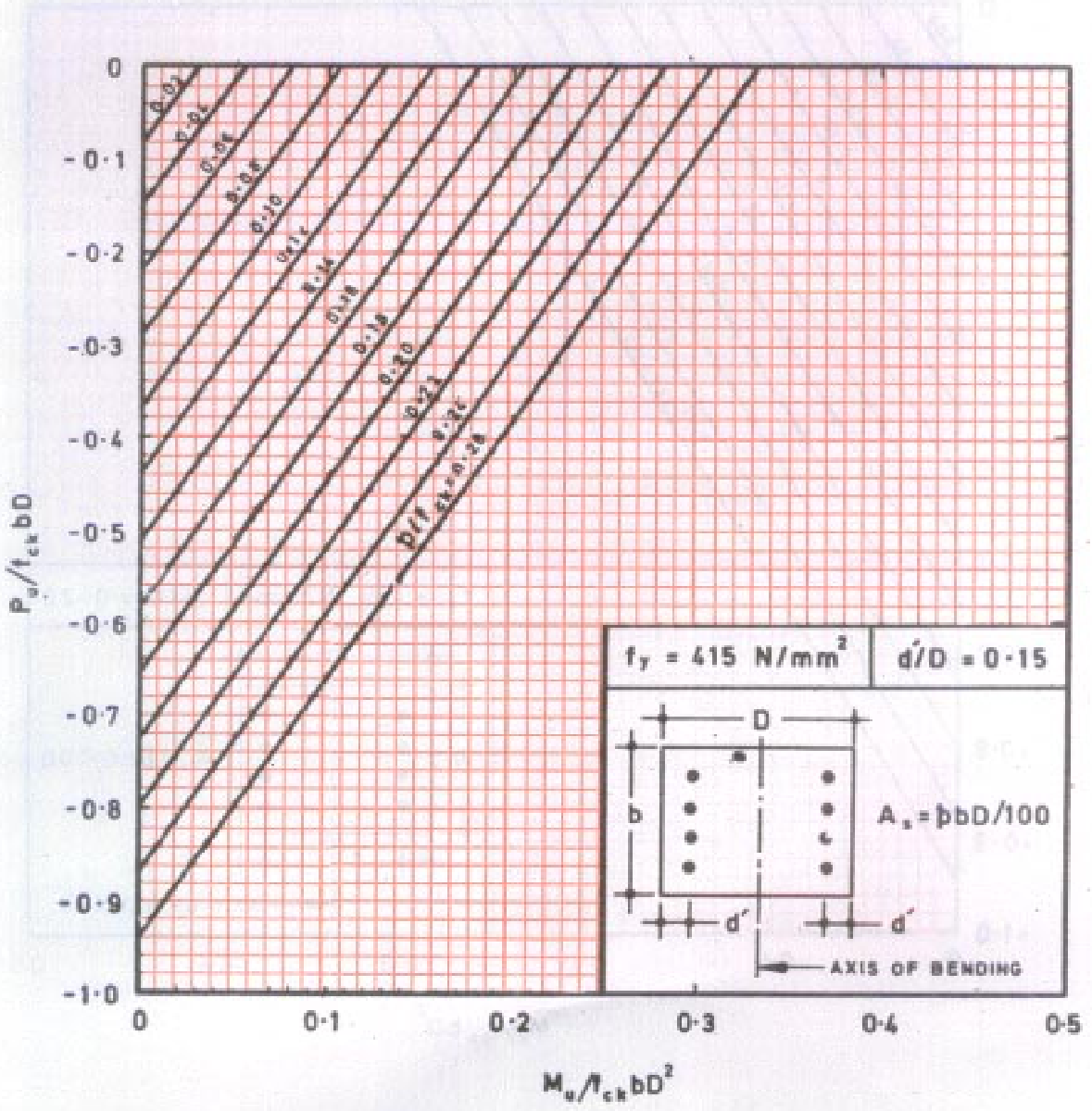
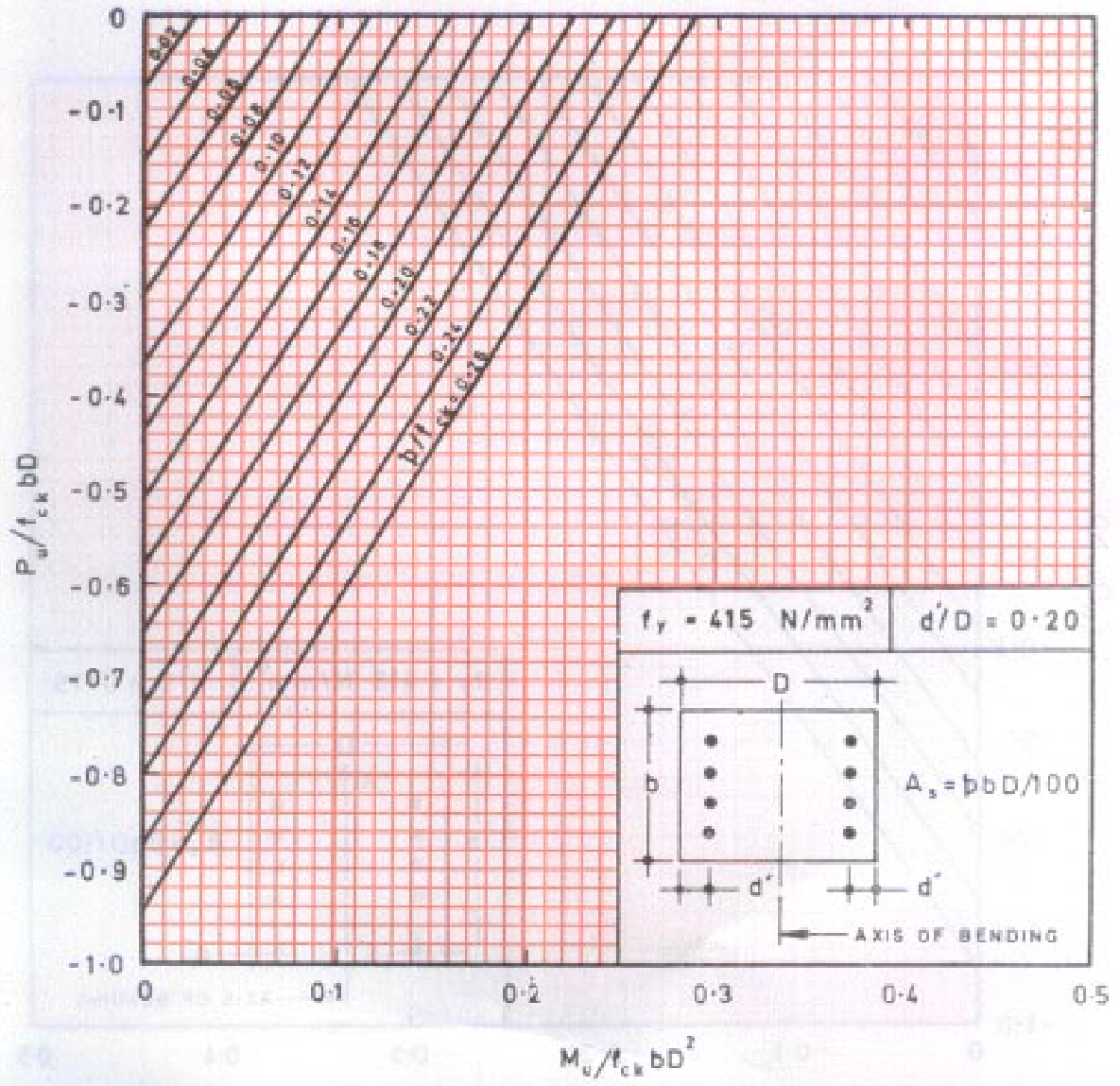


Chart 70 TENSION WITH BENDING — Rectangular Section — Reinforcement Distributed Equally on Two Sides

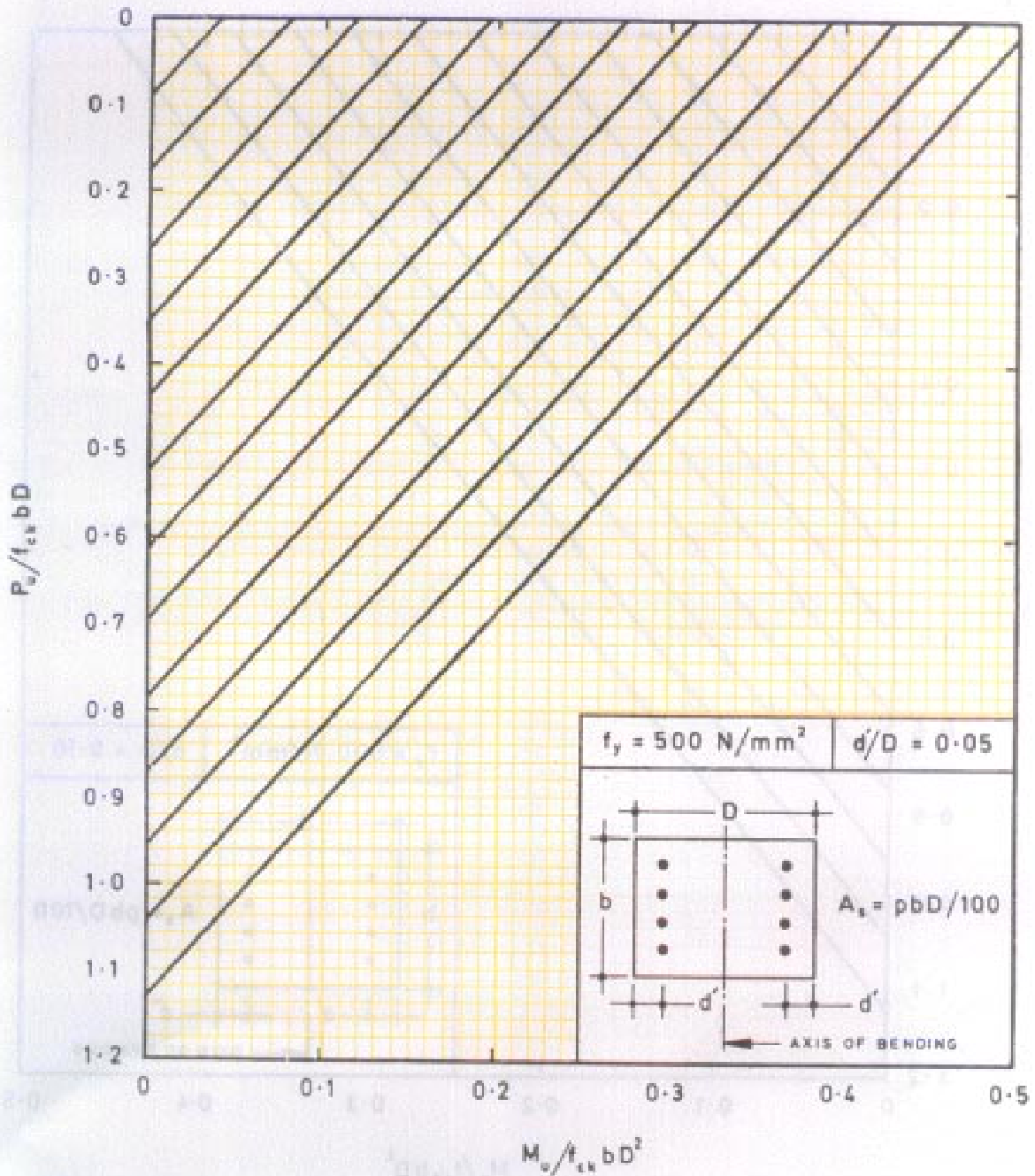




**Chart 71 TENSION WITH BENDING — Rectangular Section — Reinforcement Distributed Equally on Two Sides**

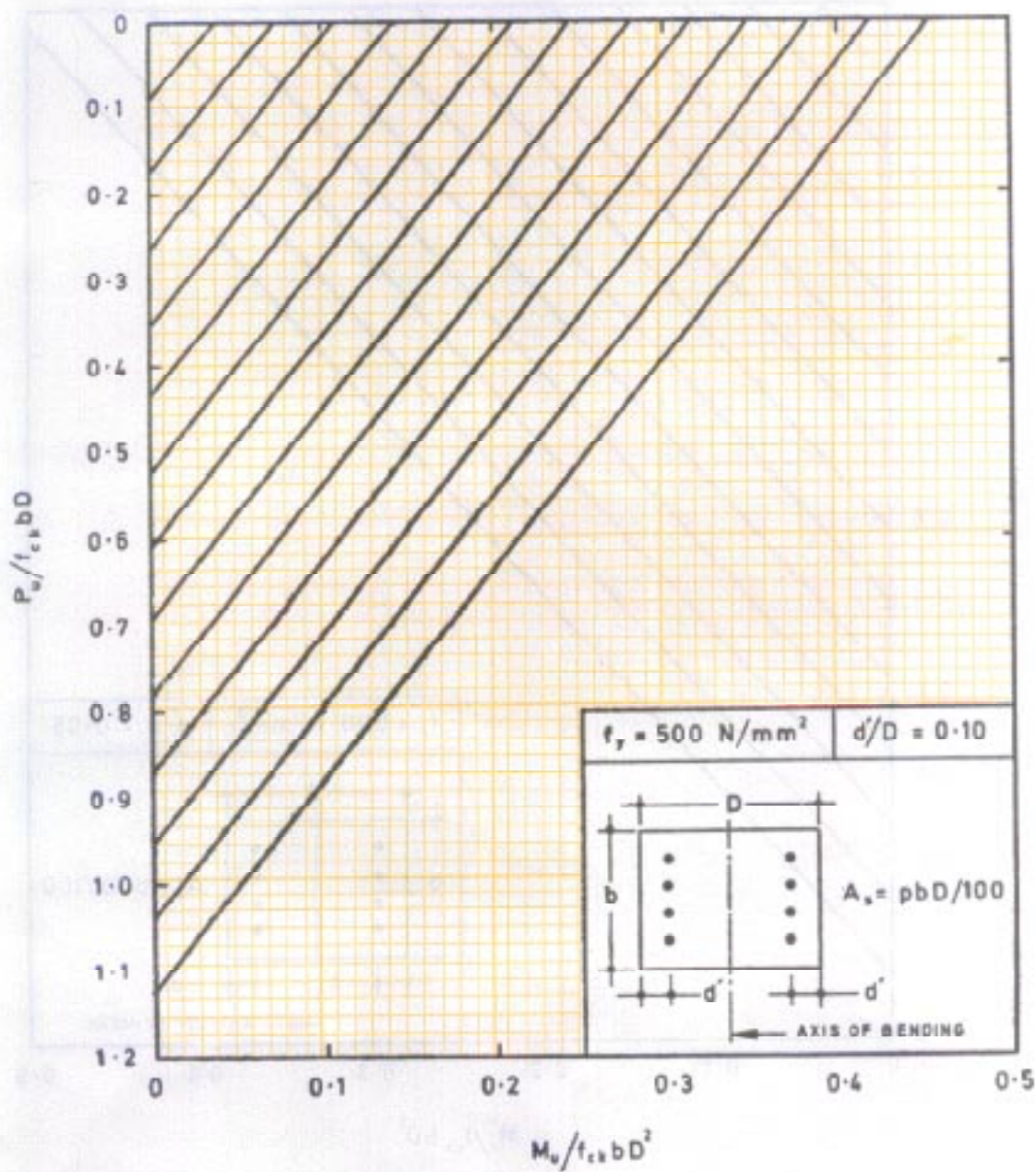


**Chart 72 TENSION WITH BENDING — Rectangular Section — Reinforcement Distributed Equally on Two Sides**

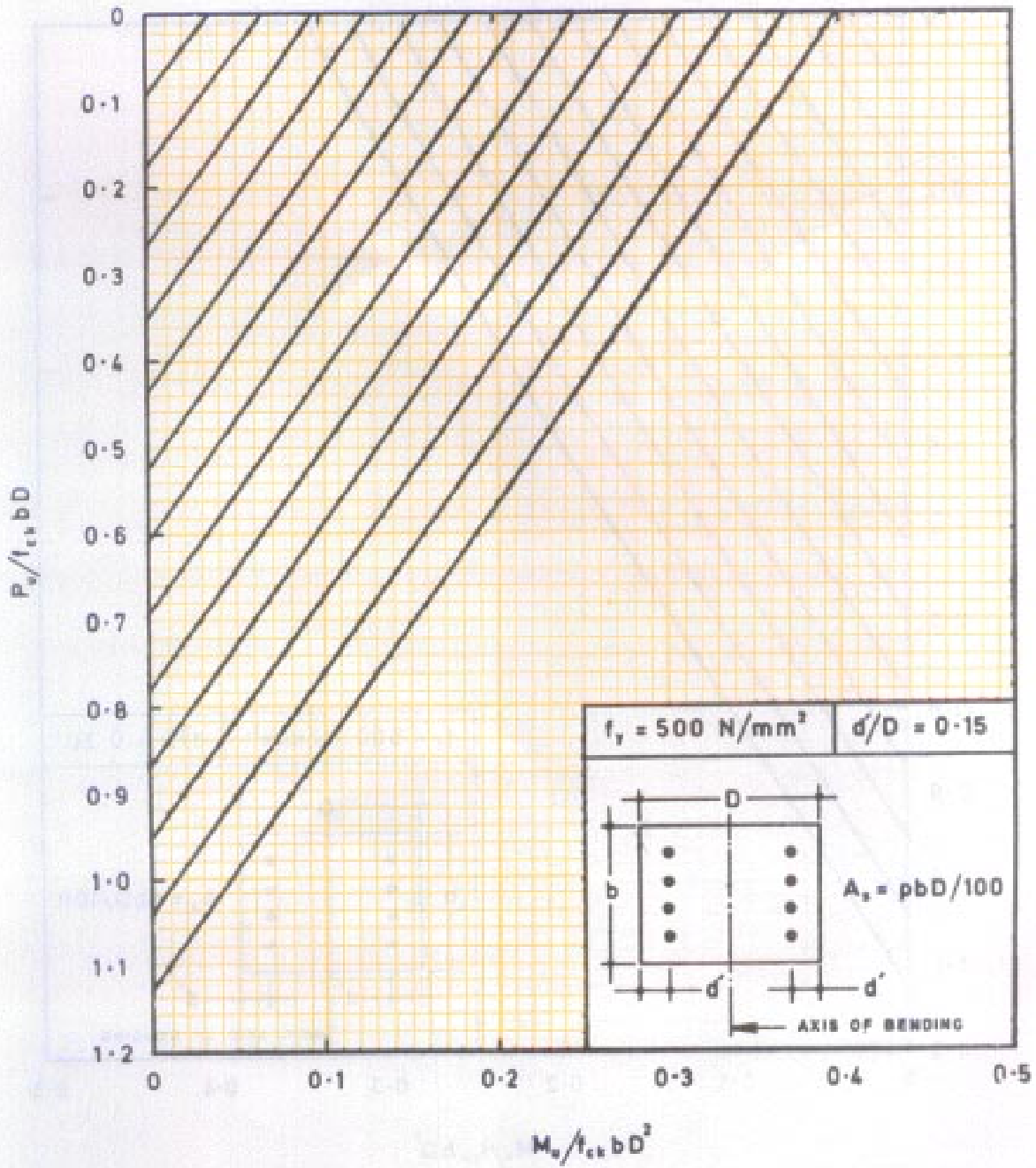


$f_y$   
500

**Chart 73 TENSION WITH BENDING — Rectangular Section — Reinforcement Distributed Equally on Two Sides**



**Chart 74 TENSION WITH BENDING — Rectangular Section — Reinforcement Distributed Equally on Two Sides**





**Chart 75 TENSION WITH BENDING — Rectangular Section — Reinforcement Distributed Equally on Two Sides**

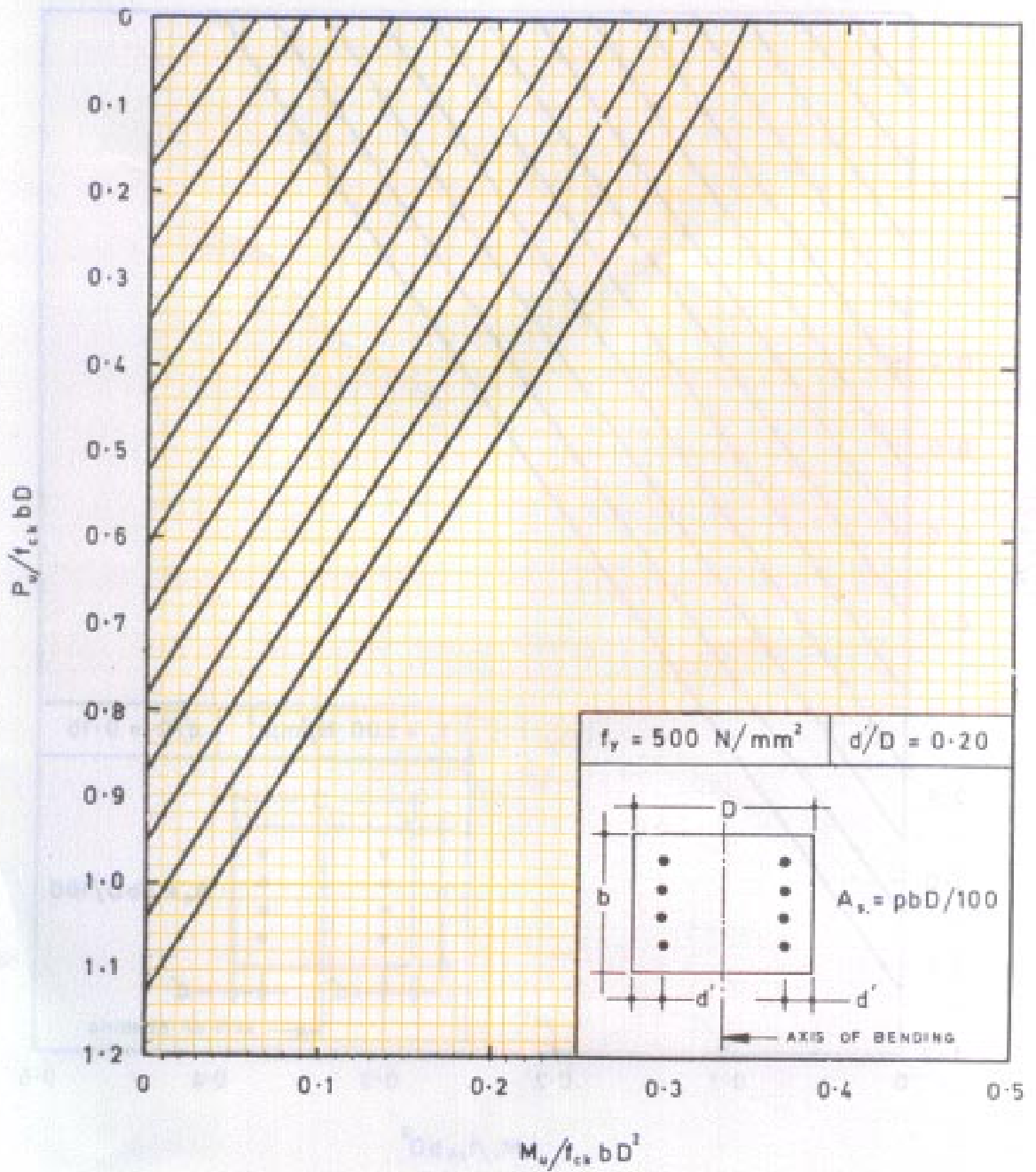
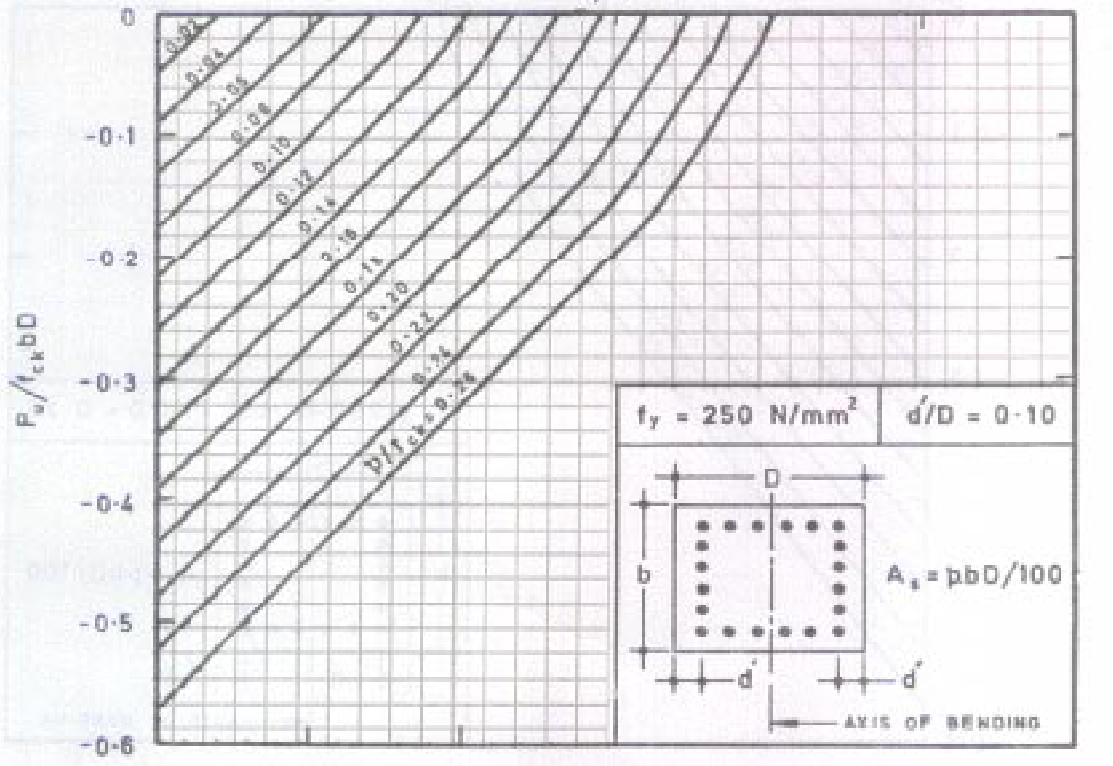
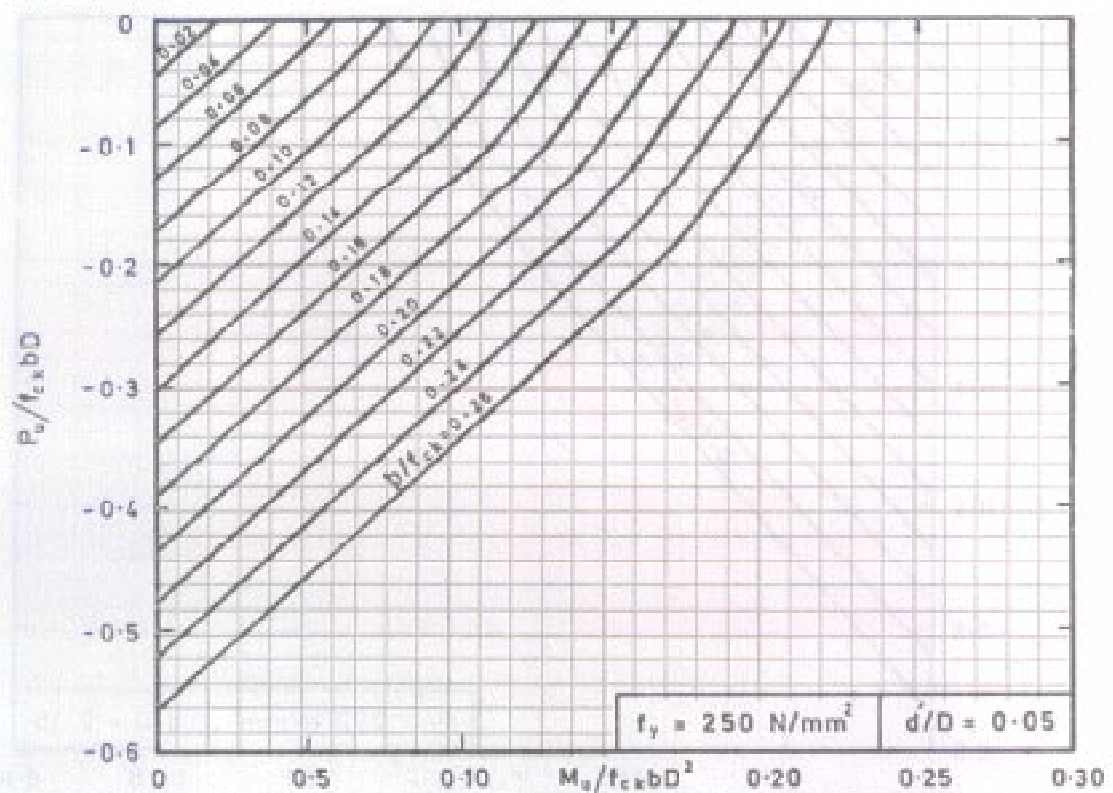
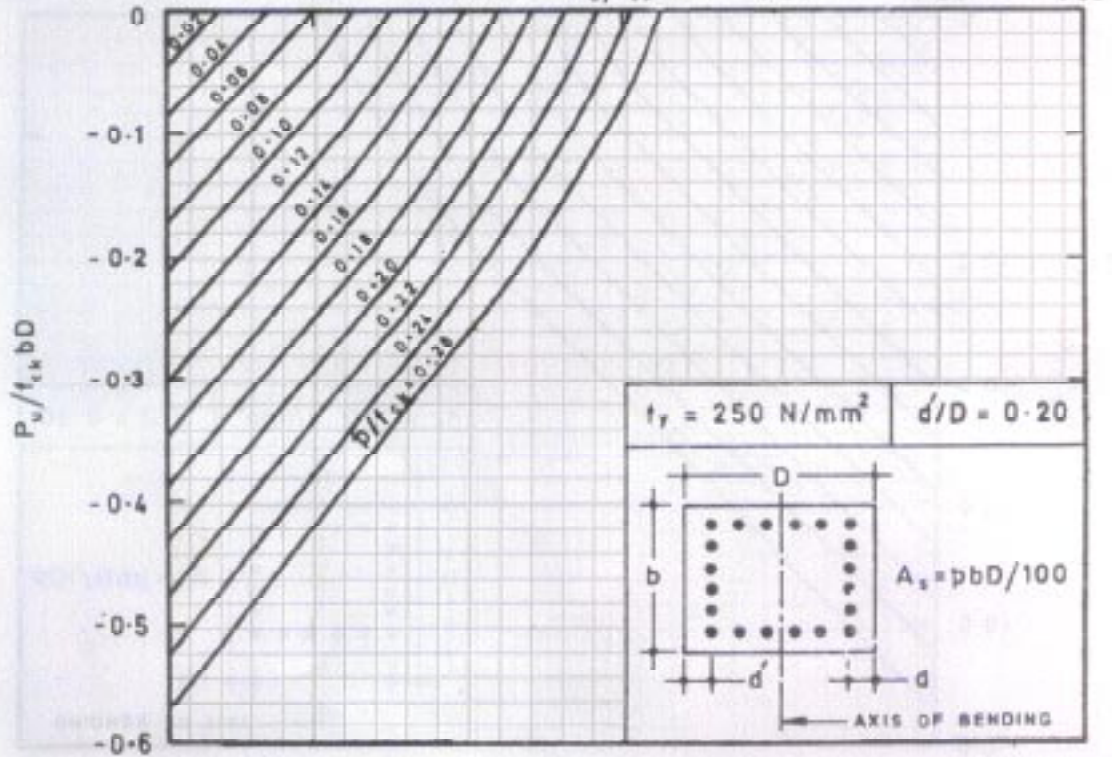
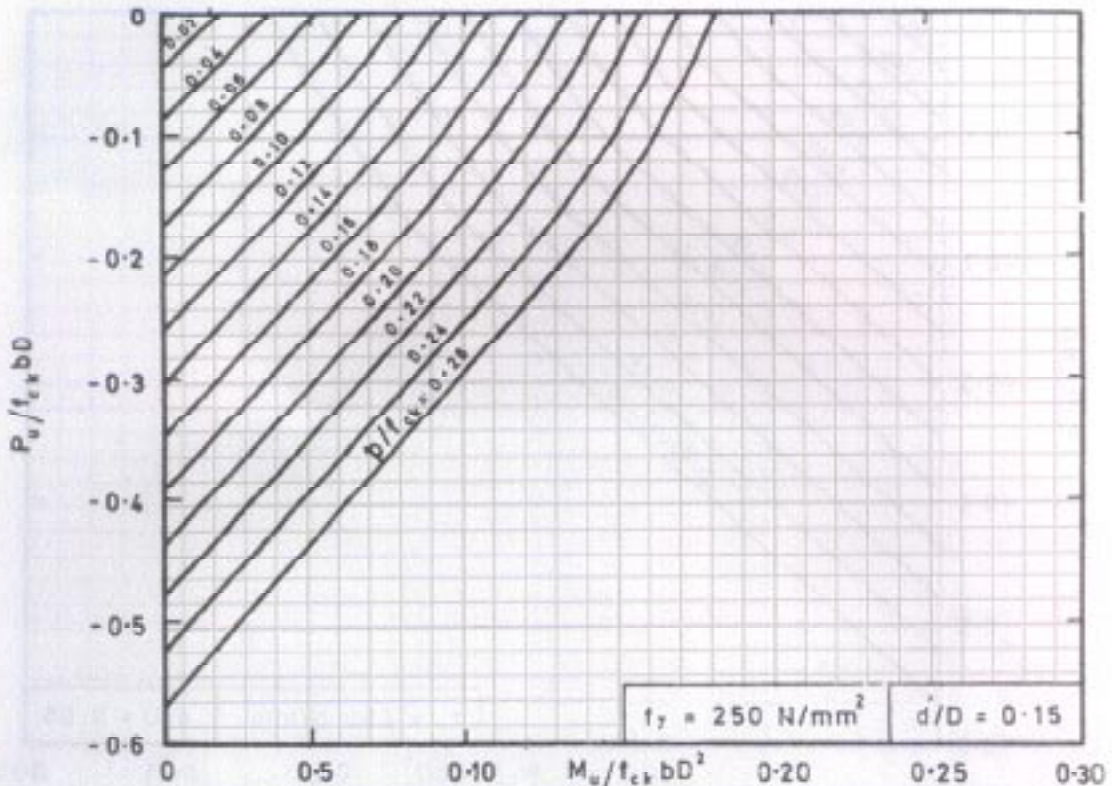


Chart 76 TENSION WITH BENDING — Rectangular Section — Reinforcement Distributed Equally on Four Sides

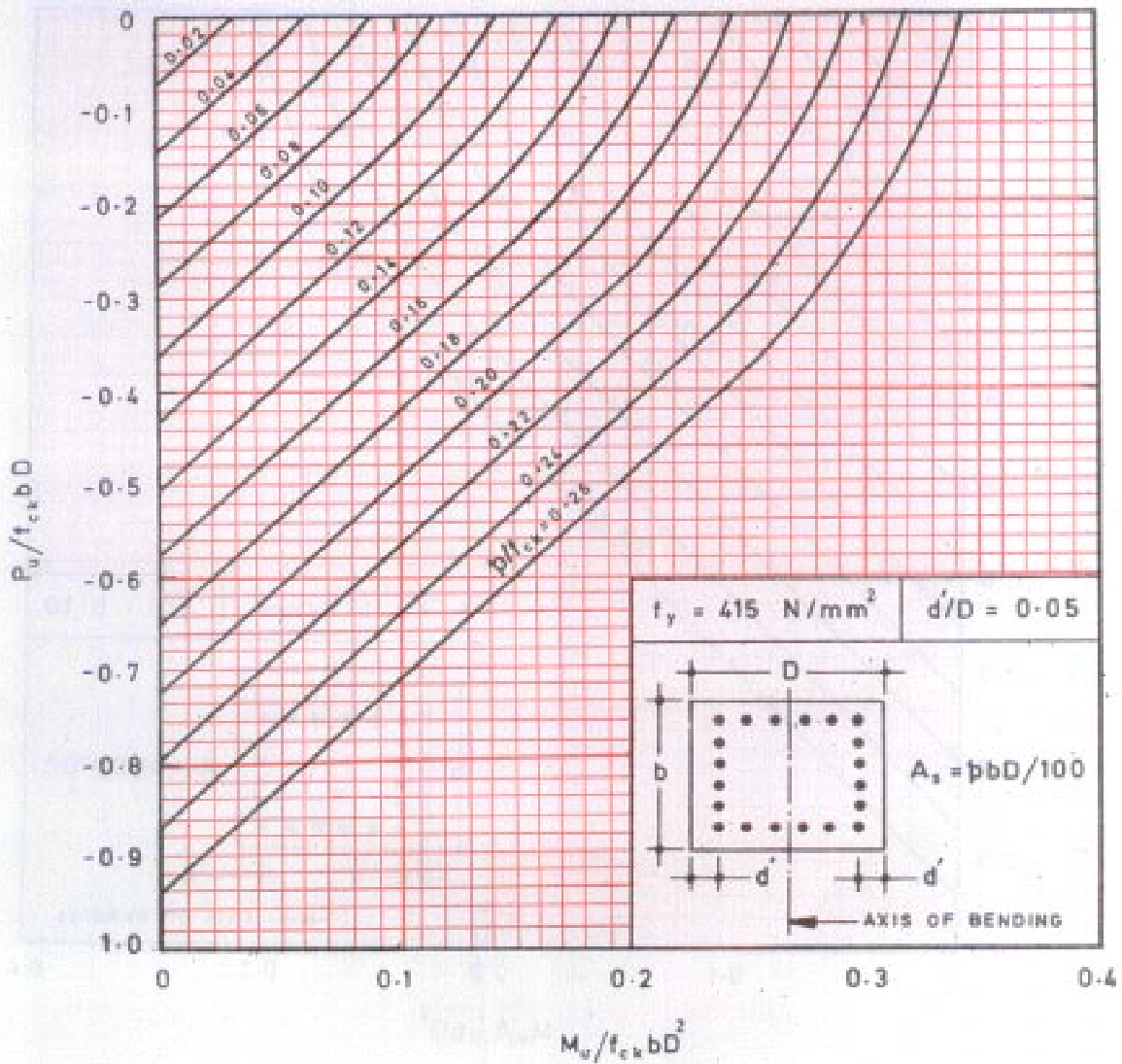




**Chart 77 TENSION WITH BENDING — Rectangular Section — Reinforcement Distributed Equally on Four Sides**



**Chart 78 TENSION WITH BENDING — Rectangular Section — Reinforcement Distributed Equally on Four Sides**



**Chart 79 TENSION WITH BENDING — Rectangular Section — Reinforcement Distributed Equally on Four Sides**

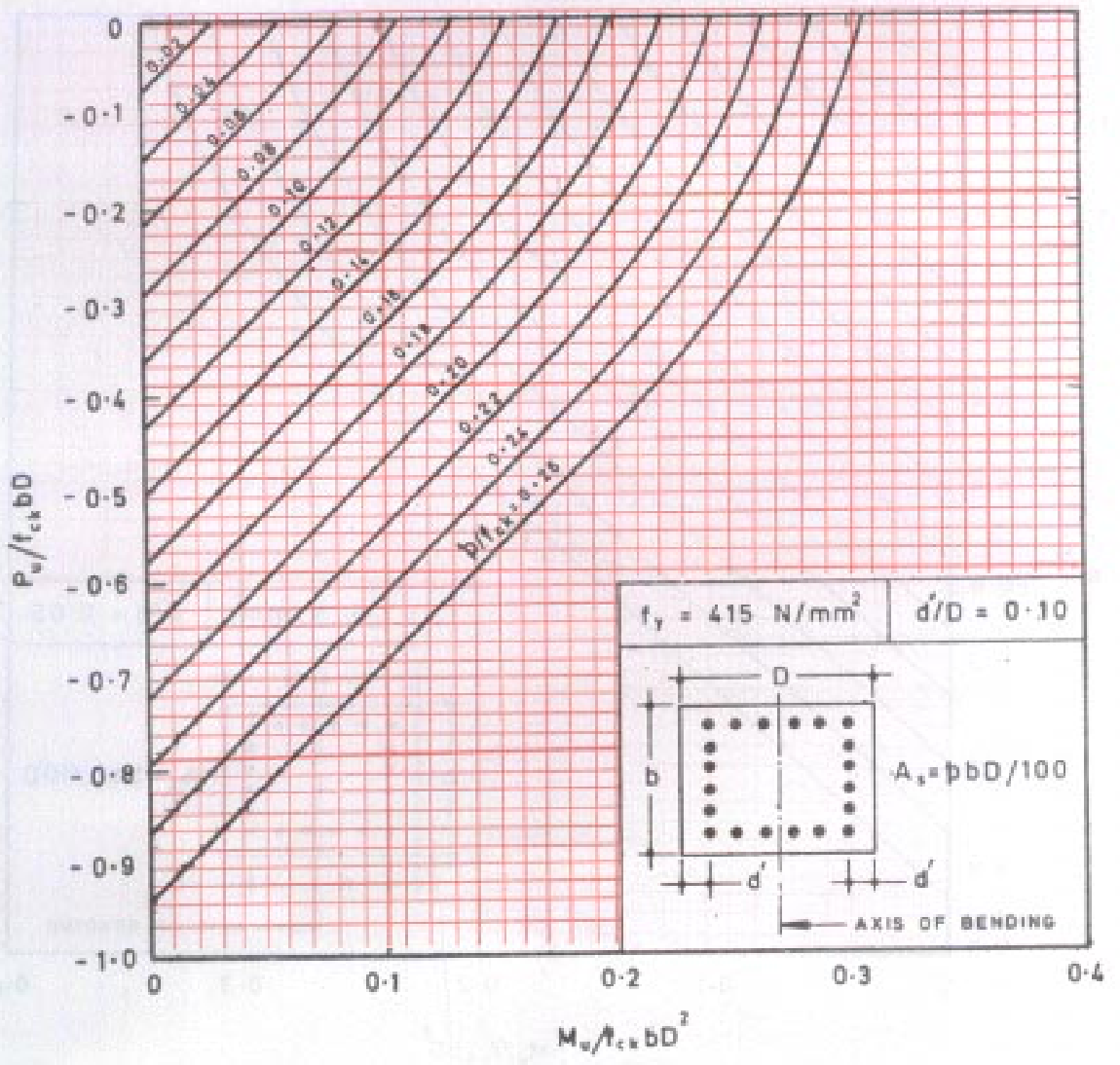
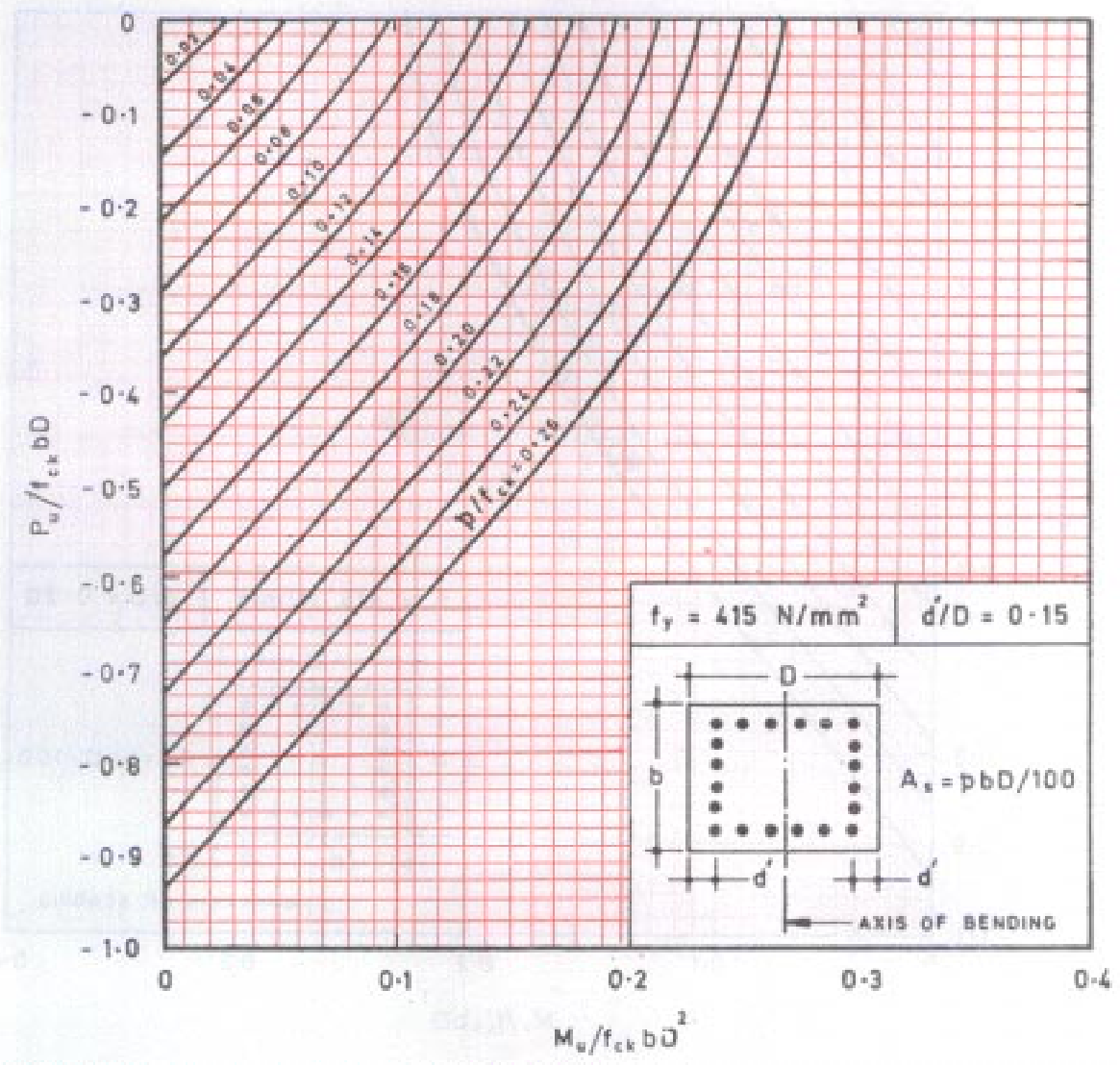
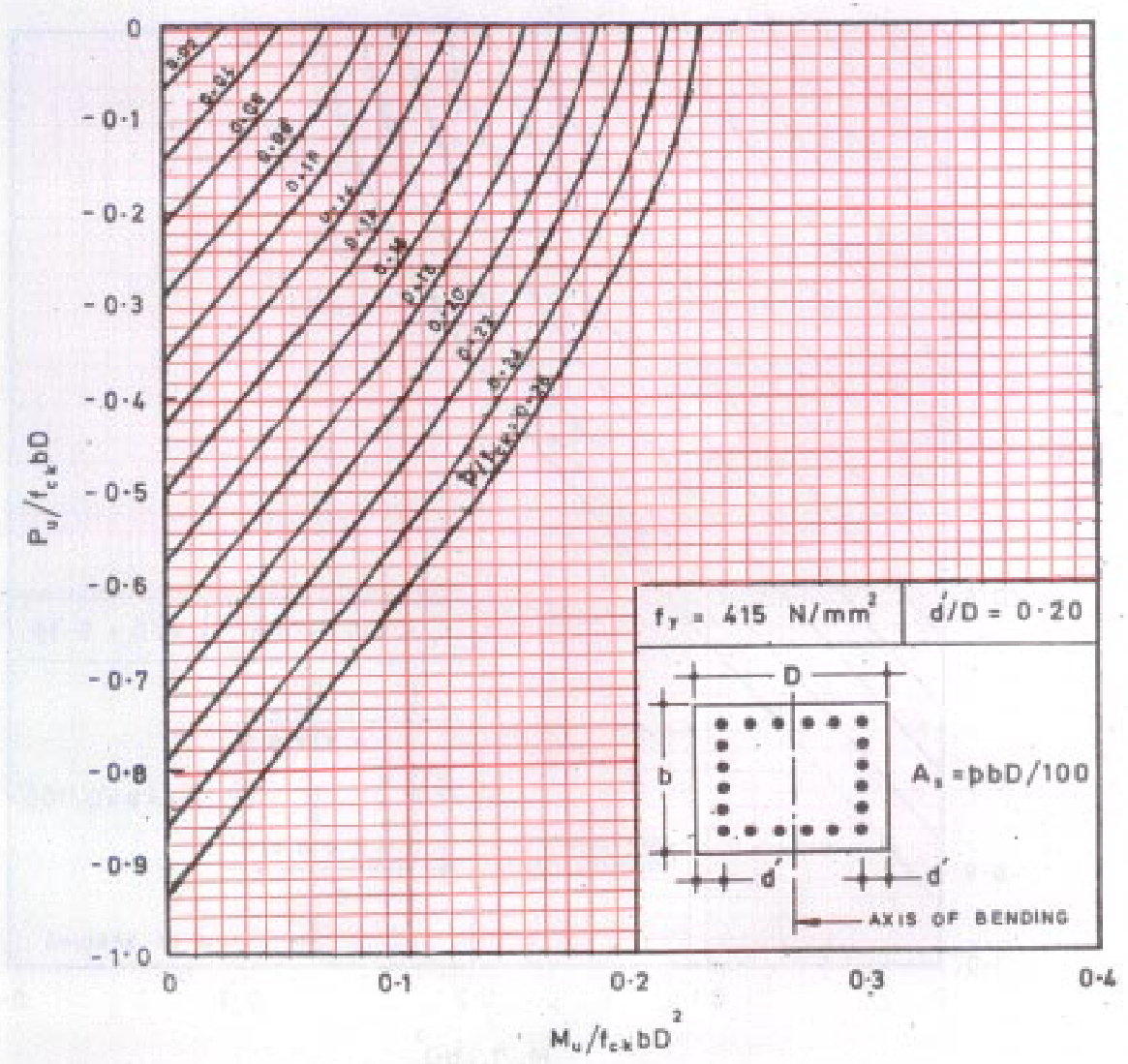


Chart 80 TENSION WITH BENDING – Rectangular Section – Reinforcement Distributed Equally on Four Sides

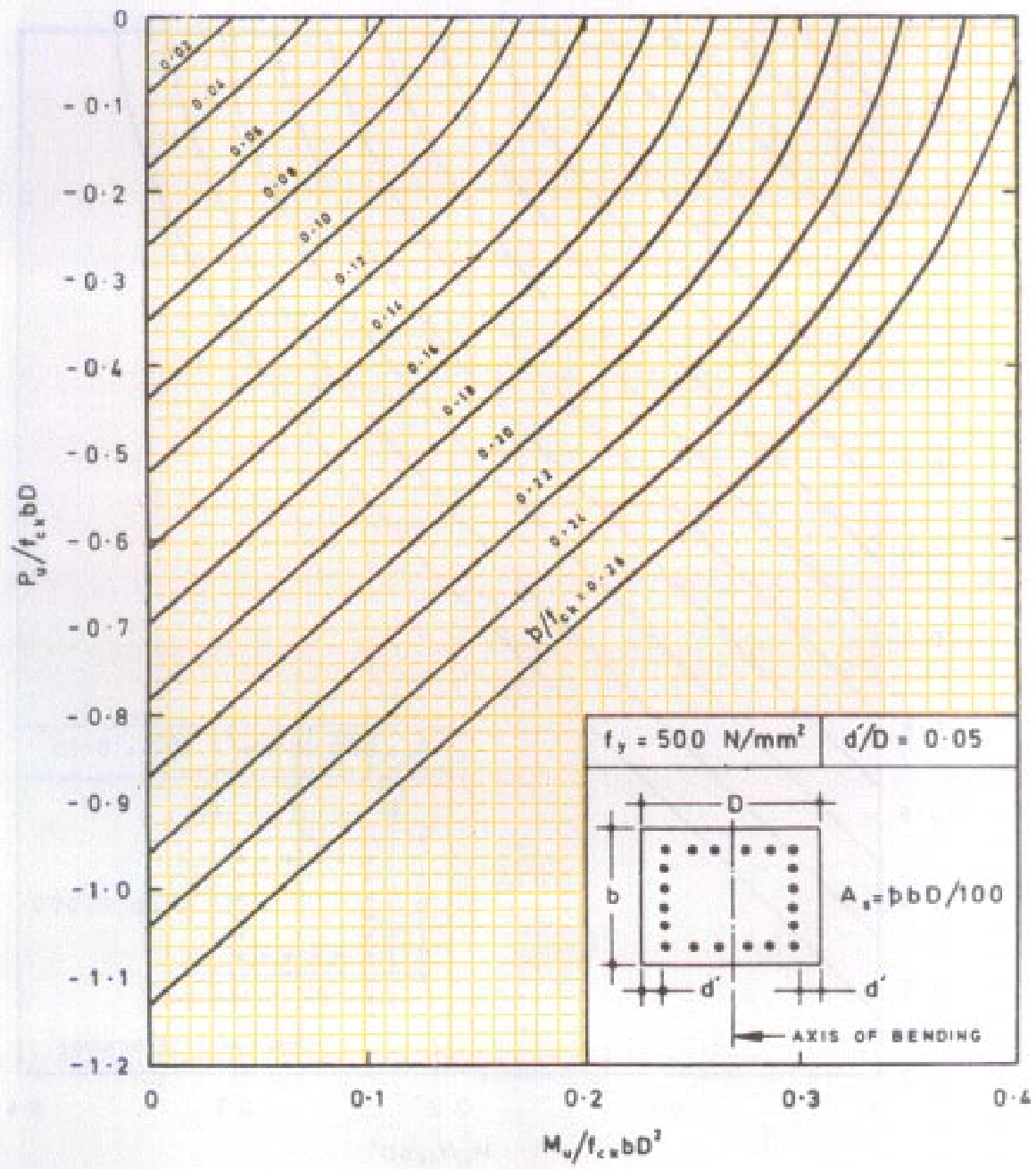




**Chart 81 TENSION WITH BENDING — Rectangular Section — Reinforcement Distributed Equally on Four Sides**

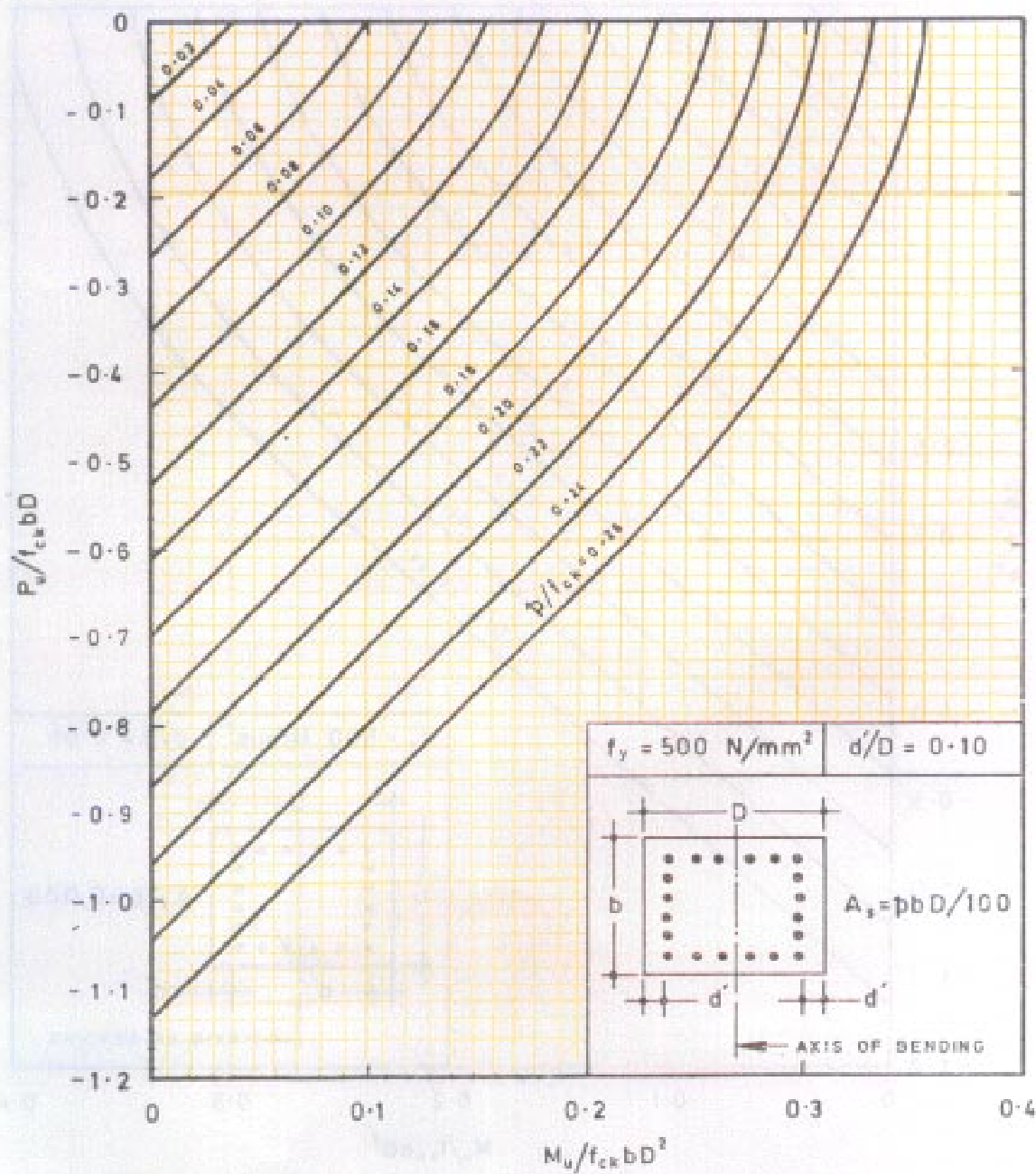


**Chart 82 TENSION WITH BENDING — Rectangular Section — Reinforcement Distributed Equally on Four Sides**

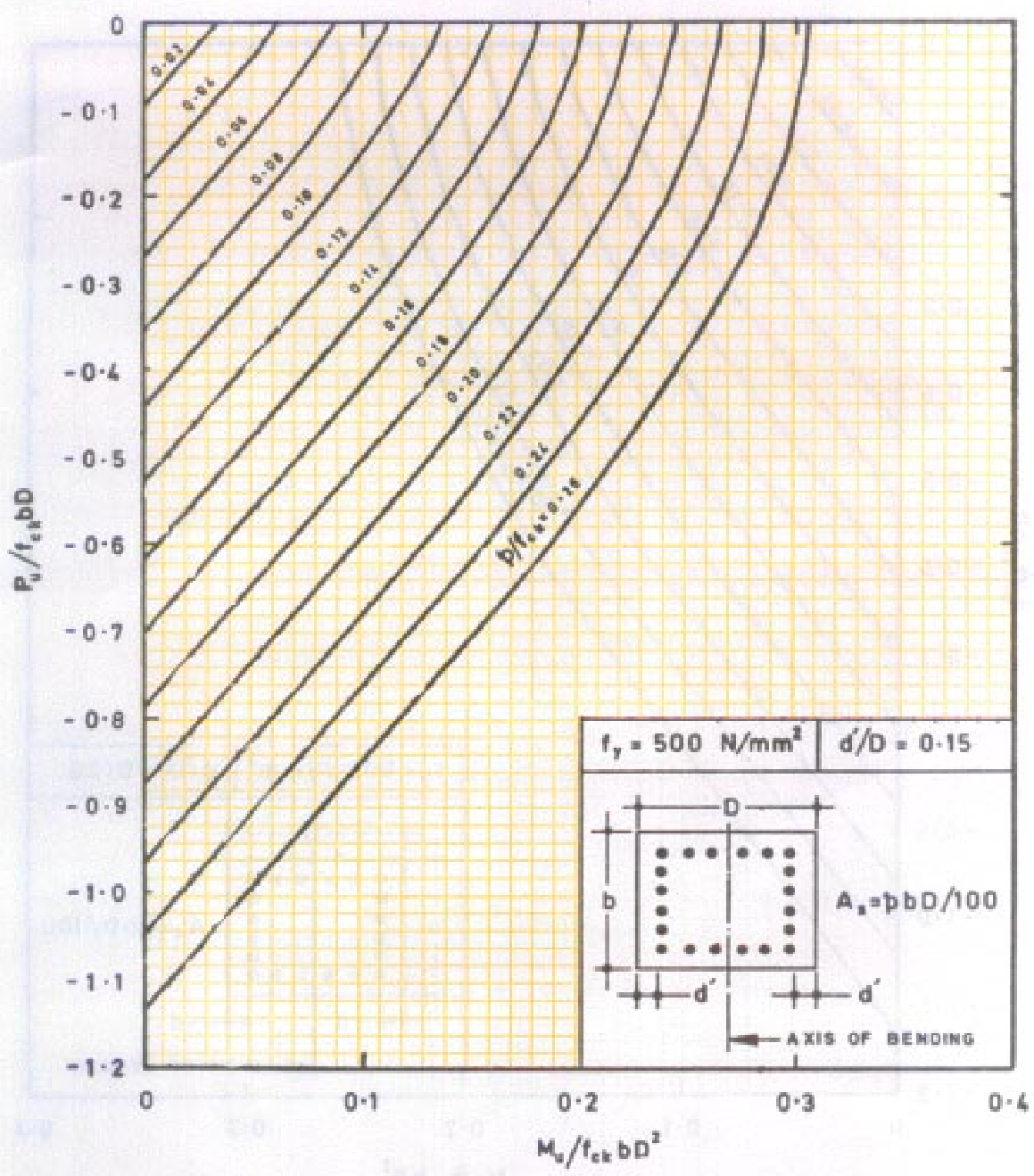




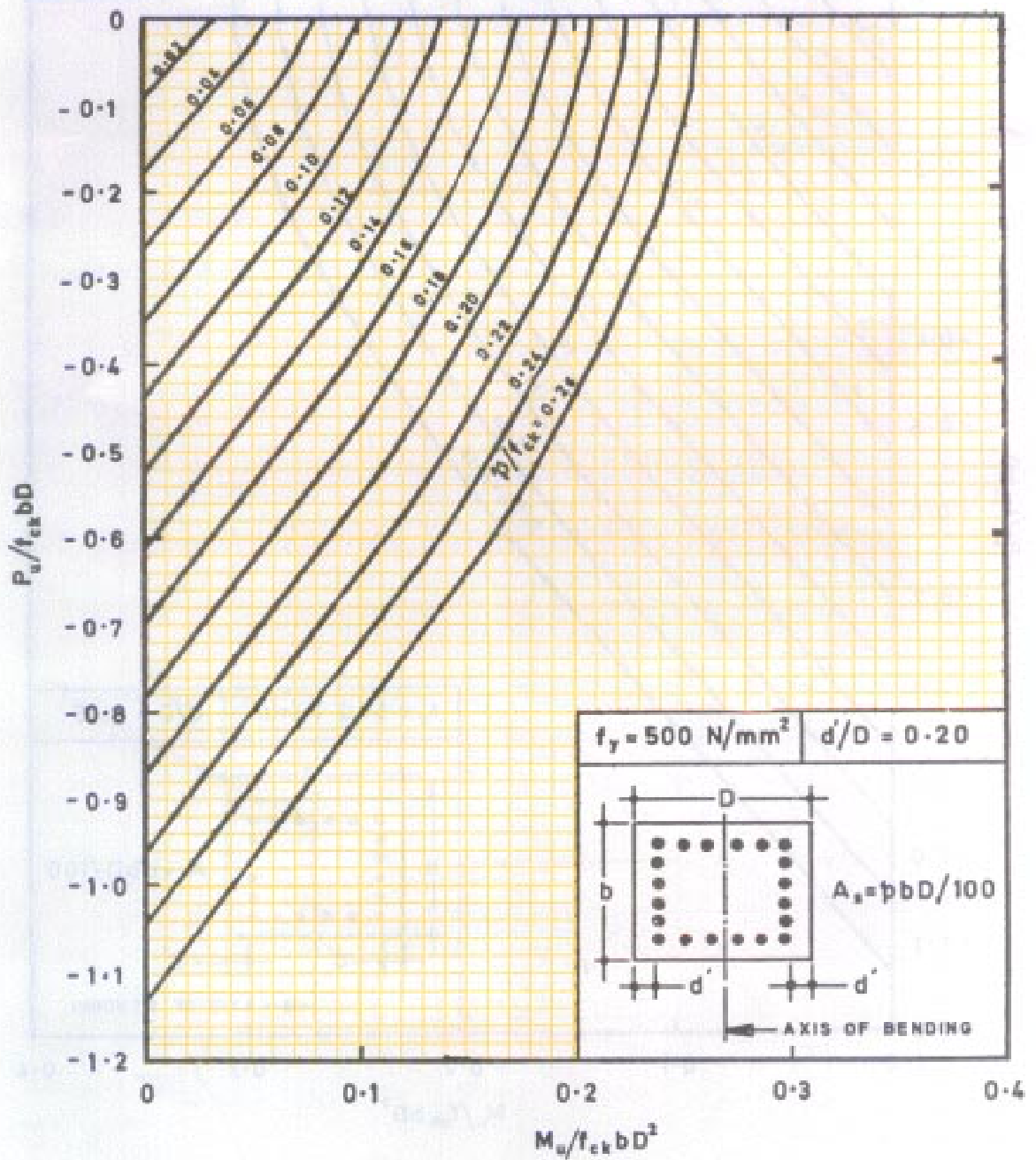
**Chart 83 TENSION WITH BENDING — Rectangular Section — Reinforcement Distributed Equally on Four Sides**



**Chart 84 TENSION WITH BENDING — Rectangular Section — Reinforcement Distributed Equally on Four Sides**



**Chart 85 TENSION WITH BENDING — Rectangular Section — Reinforcement Distributed Equally on Four Sides**



**TABLE 60 SLENDER COMPRESSION MEMBERS — VALUES OF  $P_b$**

Rectangular Sections:

$$P_b / f_{ck} bD = k_1 + k_2 p / f_{ck}$$

Circular Sections:

$$P_b / f_{ck} D^2 = k_1 + k_2 p / f_{ck}$$

Values of  $k_1$

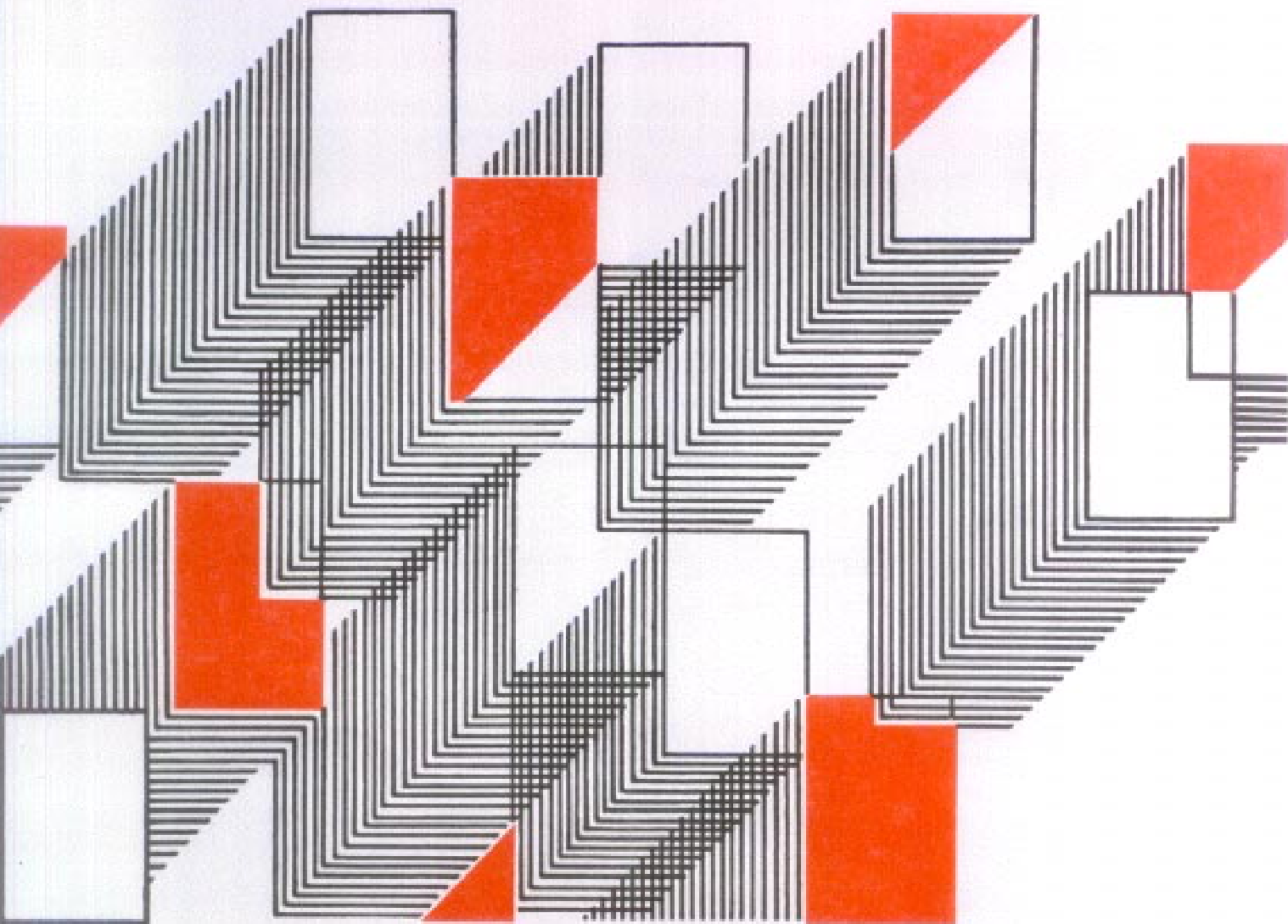
Section	$d/D$			
	0.05	0.10	0.15	0.20
Rectangular	0.219	0.207	0.196	0.184
Circular	0.172	0.160	0.149	0.138

Values of  $k_2$

Section	$f_y$ N/mm <sup>2</sup>	$d/D$			
		0.05	0.10	0.15	0.20
Rectangular; equal reinforcement on two opposite sides	250	-0.045	-0.045	-0.045	-0.045
	415	0.096	0.082	0.046	-0.022
	500	0.213	0.173	0.104	-0.001
Rectangular; equal reinforcement on four sides	250	0.215	0.146	0.061	-0.011
	415	0.424	0.328	0.203	0.028
	500	0.545	0.425	0.256	0.040
Circular	250	0.193	0.148	0.077	-0.020
	415	0.410	0.323	0.201	0.036
	500	0.543	0.443	0.291	0.056

As in the Original Standard, this Page is Intentionally Left Blank

# SHEAR AND TORSION





As in the Original Standard, this Page is Intentionally Left Blank

## 4. SHEAR AND TORSION

### 4.1 DESIGN SHEAR STRENGTH OF CONCRETE

The design shear strength of concrete is given in Table 13 of the Code. The values given in the Code are based on the following equation:

$$\tau_c = \frac{0.85 \sqrt{0.8 f_{ck}} (\sqrt{1+5\beta} - 1)}{6\beta}$$

where

$$\beta = 0.8 f_{ck} / 6.89 p_t, \text{ but not less than } 1.0, \\ \text{and } p_t = 100 A_{st} / b_w d.$$

The value of  $\tau_c$  corresponding to  $p_t$  varying from 0.20 to 3.00 at intervals of 0.10 are given in Table 61 for different grades of concrete.

### 4.2 NOMINAL SHEAR STRESS

The nominal shear stress  $\tau_v$  is calculated by the following equation:

$$\tau_v = \frac{V_u}{bd}$$

where

$V_u$  is the shear force.

When  $\tau_v$  exceeds  $\tau_c$ , shear reinforcement should be provided for carrying a shear equal to  $V_u - \tau_c bd$ . The shear stress  $\tau_v$  should not in any case exceed the values of  $\tau_{c,max}$ , given in Table J. (If  $\tau_v > \tau_{c,max}$ , the section is to be redesigned.)

CONCRETE GRADE	M15	M20	M25	M30	M35	M40
$\tau_{c,max}, \text{N/mm}^2$	2.5	2.8	3.1	3.5	3.7	4.0

### 4.3 SHEAR REINFORCEMENT

The design shear strength of vertical stirrups is given by the following equation:

$$V_{us} = \frac{0.87 f_y A_{sv} d}{s_v}$$

where

$A_{sv}$  is the total cross sectional area of the vertical legs of the stirrups, and  
 $s_v$  is the spacing (pitch) of the stirrups.

The shear strength expressed as  $V_{us}/d$  are given in Table 62 for different diameters and spacings of stirrups, for two grades of steel.

For a series of inclined stirrups, the value of  $V_{us}/d$  for vertical stirrups should be multiplied by  $(\sin \alpha + \cos \alpha)$  where  $\alpha$  is the angle between the inclined stirrups and the axis of the member. The multiplying factor works out to 1.41 and 1.37 for 45° and 60° angles respectively.

For a bent up bar,

$$V_{us} = 0.87 f_y A_{sv} \sin \alpha$$

Values of  $V_{us}$  for different sizes of bars, bent up at 45° and 60° to the axis of the member are given in Table 63 for two grades of steel.

### 4.4 TORSION

Separate Charts or Tables are not given for torsion. The method of design for torsion is based on the calculation of an equivalent shear force and an equivalent bending moment. After determining these, some of the Charts and Tables for shear and flexure can be used. The method of design for torsion is illustrated in Example 11.

#### Example 10 Shear

Determine the shear reinforcement (vertical stirrups) required for a beam section with the following data:

Beam size	30 × 60 cm
Depth of beam	60 cm
Concrete grade	M 15
Characteristic strength of stirrup reinforcement	250 N/mm <sup>2</sup>
Tensile reinforcement percentage	0.8
Factored shear force, $V_u$	180 kN

Assuming 25 mm dia bars with 25 mm cover,

$$d = 60 - \frac{2.5}{2} - 2.5 = 56.25 \text{ cm}$$

$$\text{Shear stress, } \tau_v = \frac{V_u}{bd} = \frac{180 \times 10^3}{30 \times 56.25 \times 10^3} \\ = 1.07 \text{ N/mm}^2$$

From Table J for M15,  $\tau_{c,max} = 2.5 \text{ N/mm}^2$   
 $\tau_v$  is less than  $\tau_{c,max}$

From Table 61, for  $P_t = 0.8$ ,  $\tau_c = 0.55 \text{ N/mm}^2$

$$\text{Shear capacity of concrete section} = \tau_c bd \\ = 0.55 \times 30 \times 56.25 \times 10^2 / 10^3 = 92.8 \text{ kN}$$

Shear to be carried by stirrups,  $V_{us} = V_s - \tau_c b d$   
 $= 180 - 92.8 = 87.2 \text{ kN}$

$$\frac{V_{us}}{d} = \frac{87.2}{56.25} = 1.55 \text{ kN/cm}$$

Referring to Table 62, for steel  $f_y = 250 \text{ N/mm}^2$ .  
 Provide 8 mm diameter two legged vertical stirrups at 14 cm spacing.

### Example 11 Torsion

Determine the reinforcements required for a rectangular beam section with the following data:

Size of the beam	30 × 60 cm
Concrete grade	M 15
Characteristic strength of steel	415 N/mm <sup>2</sup>
Factored shear force	95 kN
Factored torsional moment	45 kN.m
Factored bending moment	115 kN.m

Assuming 25 mm dia bars with 25 mm cover,

$$d = 60 - 2.5 - \frac{2.5}{2} = 56.25 \text{ cm}$$

Equivalent shear,

$$V_e = V + 1.6 \left( \frac{T}{b} \right)$$

$$= 95 + 1.6 \times \frac{45}{0.3} = 95 + 240 = 335 \text{ kN}$$

Equivalent shear stress.

$$\tau_{ve} = \frac{V_e}{b d} = \frac{335 \times 10^3}{30 \times 56.25 \times 10^3} = 1.99 \text{ N/mm}^2$$

From Table J, for M15,  $\tau_{c, \max} = 2.5 \text{ N/mm}^2$

$\tau_{ve}$  is less than  $\tau_{c, \max}$ ; hence the section does not require revision.

From Table 61, for an assumed value of  $p_t = 0.5$ .

$$\tau_c = 0.46 \text{ N/mm}^2 < \tau_{ve}.$$

Hence longitudinal and transverse reinforcements are to be designed. Longitudinal reinforcement (see 40.4.2 of the Code):

Equivalent bending moment,

$$\begin{aligned} M_{e1} &= M_u + M_t \\ &= M_u + \frac{T_u (1 + D/b)}{1.7} \\ &= 115 + 45 \left( 1 + \frac{60}{30} \right) / 1.7 \\ &= 115 + 79.4 \\ &= 194.4 \text{ kN.m} \end{aligned}$$

$$M_{e1}/bd^2 = \frac{194.4 \times 10^3}{30 \times (56.25)^2 \times 10^3} = 2.05 \text{ N/mm}^2$$

Referring to Table 1, corresponding to  $M_u/bd^2 = 2.05$

$$p_t = 0.708$$

$$A_{st} = 0.708 \times 30 \times 56.25/100 = 11.95 \text{ cm}^2$$

Provide 4 bars of 20 mm dia ( $A_{st} = 12.56 \text{ cm}^2$ ) on the flexural tensile face. As  $M_t$  is less than  $M_u$ , we need not consider  $M_{e2}$  according to 40.4.2.1 of the Code. Therefore, provide only two bars of 12 mm dia on the compression face, one bar being at each corner.

As the depth of the beam is more than 45 cm, side face reinforcement of 0.05 percent on each side is to be provided (see 25.5.1.7 and 25.5.1.3 of the Code). Providing one bar at the middle of each side,

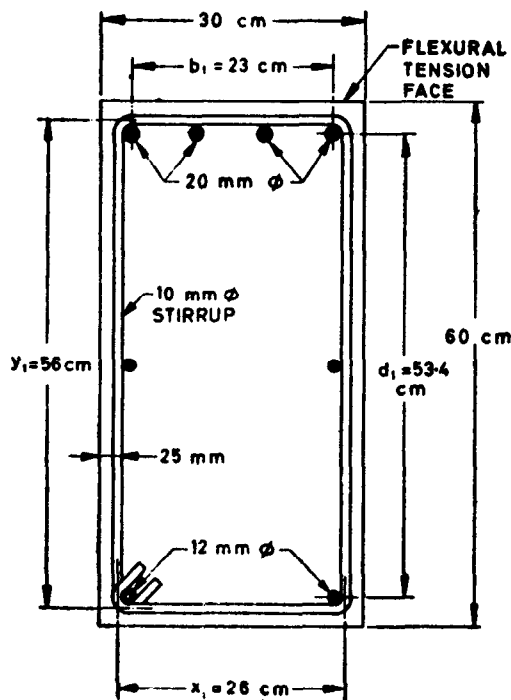
$$\text{Spacing of bar} = 53.4/2 = 26.7 \text{ cm}$$

$$\begin{aligned} \text{Area required for each bar} &= \frac{0.05 \times 30 \times 26.7}{100} \\ &= 0.40 \text{ cm}^2 \end{aligned}$$

Provide one bar of 12 mm dia on each side. Transverse reinforcement (see 40.4.3 of the Code):

Area of two legs of the stirrup should satisfy the following:

$$A_{st} = \frac{T_u S_v}{b_1 d_1 (0.87 f_y)} + \frac{V_u S_v}{2.5 d_1 (0.87 f_y)}$$



Assuming diameter of stirrups as 10 mm

$$d_1 = 60 - (2.5 + 1.0) - (2.5 + 0.6) = 53.4 \text{ cm}$$

$$b_1 = 30 - 2(2.5 + 1.0) = 23 \text{ cm}$$

$$\frac{A_{sv}(0.87 f_y)}{S_v} = \frac{45 \times 10^2}{23 \times 53.4 \times 10^2}$$

$$+ \frac{95 \times 10^2}{2.5 \times 53.4 \times 10} = 366.4 + 71.2$$

$$= 437.6 \text{ N/mm}$$

$$= 4.38 \text{ kN/cm}$$

Area of all the legs of the stirrup should satisfy the condition that  $A_{sv}/S_v$  should not

be less than  $\frac{(\tau_{ve} - \tau_e)b}{0.87 f_y}$

From Table 61, for tensile reinforcement percentage of 0.71, the value of  $\tau_e$  is 0.53 N/mm<sup>2</sup>

$$\frac{A_{sv}(0.87 f_y)}{S_v} = (\tau_{ve} - \tau_e)b$$

$$= (1.99 - 0.53)$$

$$30 \times 10$$

$$= 438 \text{ N/mm} = 4.38 \text{ kN/cm}$$

NOTE—It is only a coincidence that the values of  $A_{sv}(0.87 f_y)/S_v$  calculated by the two equations are the same.

Referring Table 62 (for  $f_y = 415 \text{ N/mm}^2$ ).

Provide 10 mm  $\phi$  two legged stirrups at 12.5 cm spacing.

According to 25.5.1.7(a) of the Code, the spacing of stirrups shall not exceed  $x_1$ ,  $(x_1 + y_1)/4$  and 300 mm, where  $x_1$  and  $y_1$  are the short and long dimensions of the stirrup.

$$x_1 = 30 - 2(2.5 - 0.5) = 26 \text{ cm}$$

$$y_1 = 60 - 2(2.5 - 0.5) = 56 \text{ cm}$$

$$(x_1 + y_1)/4 = (26 + 56)/4 = 20.5 \text{ cm}$$

10 mm  $\phi$  two legged stirrups at 12.5 cm spacing will satisfy all the codal requirements.

$f_{ck}$   
15  
20  
25  
30  
35  
40

TABLE 61 SHEAR — DESIGN SHEAR STRENGTH OF CONCRETE,  $\tau_c$ , N/mm<sup>2</sup>

$P_t$	$f_{ck}, \text{N/mm}^2$					
	15	20	25	30	35	40
0.20	0.32	0.33	0.33	0.33	0.34	0.34
0.30	0.38	0.39	0.39	0.40	0.40	0.41
0.40	0.43	0.44	0.45	0.45	0.46	0.46
0.50	0.46	0.48	0.49	0.50	0.50	0.51
0.60	0.50	0.51	0.53	0.54	0.54	0.55
0.70	0.53	0.55	0.56	0.57	0.58	0.59
0.80	0.55	0.57	0.59	0.60	0.61	0.62
0.90	0.57	0.60	0.62	0.63	0.64	0.65
1.00	0.60	0.62	0.64	0.66	0.67	0.68
1.10	0.62	0.64	0.66	0.68	0.69	0.70
1.20	0.63	0.66	0.69	0.70	0.72	0.73
1.30	0.65	0.68	0.71	0.72	0.74	0.75
1.40	0.67	0.70	0.72	0.74	0.76	0.77
1.50	0.68	0.72	0.74	0.76	0.78	0.79
1.60	0.69	0.73	0.76	0.78	0.80	0.81
1.70	0.71	0.75	0.77	0.80	0.81	0.83
1.80	0.71	0.76	0.79	0.81	0.83	0.85
1.90	0.71	0.77	0.80	0.83	0.85	0.86
2.00	0.71	0.79	0.82	0.84	0.86	0.88
2.10	0.71	0.80	0.83	0.86	0.88	0.90
2.20	0.71	0.81	0.84	0.87	0.89	0.91
2.30	0.71	0.82	0.86	0.88	0.91	0.93
2.40	0.71	0.82	0.87	0.90	0.92	0.94
2.50	0.71	0.82	0.88	0.91	0.93	0.95
2.60	0.71	0.82	0.89	0.92	0.94	0.97
2.70	0.71	0.82	0.90	0.93	0.96	0.98
2.80	0.71	0.82	0.91	0.94	0.97	0.99
2.90	0.71	0.82	0.92	0.95	0.98	1.00
3.00	0.71	0.82	0.92	0.96	0.99	1.01

**TABLE 62 SHEAR — VERTICAL STIRRUPS**

 Values of  $V_{us}/d$  for two legged stirrups, kN/cm.

STIRRUP SPACING, cm	$f_y = 250 \text{ N/mm}^2$				$f_y = 415 \text{ N/mm}^2$			
	DIAMETER, mm				DIAMETER, mm			
	6	8	10	12	6	8	10	12
5	2.460	4.373	6.833	9.839	4.083	7.259	11.342	16.334
6	2.050	3.644	5.694	8.200	3.403	6.049	9.452	13.611
7	1.757	3.124	4.881	7.028	2.917	5.185	8.102	11.667
8	1.537	2.733	4.271	6.150	2.552	4.537	7.089	10.208
9	1.367	2.429	3.796	5.466	2.269	4.033	6.302	9.074
10	1.230	2.186	3.416	4.920	2.042	3.630	5.671	8.167
11	1.118	1.988	3.106	4.472	1.856	3.299	5.156	7.424
12	1.025	1.822	2.847	4.100	1.701	3.025	4.726	6.806
13	0.946	1.682	2.628	3.784	1.571	2.792	4.363	6.286
14	0.879	1.562	2.440	3.514	1.458	2.593	4.051	5.833
15	0.820	1.458	2.278	3.280	1.361	2.420	3.781	5.445
16	0.769	1.366	2.135	3.075	1.276	2.269	3.545	5.104
17	0.723	1.286	2.010	2.894	1.201	2.135	3.336	4.804
18	0.683	1.215	1.898	2.733	1.134	2.016	3.151	4.537
19	0.647	1.151	1.798	2.589	1.075	1.910	2.985	4.298
20	0.615	1.093	1.708	2.460	1.020	1.815	2.836	4.083
25	0.492	0.875	1.367	1.968	0.817	1.452	2.269	3.267
30	0.410	0.729	1.139	1.640	0.681	1.210	1.890	2.722
35	0.351	0.625	0.976	1.406	0.583	1.037	1.620	2.333
40	0.307	0.547	0.854	1.230	0.510	0.907	1.418	2.042
45	0.273	0.486	0.759	1.093	0.454	0.807	1.260	1.815

**TABLE 63 SHEAR — BENT-UP BARS**

 Values of  $V_{us}$  for single bar, kN

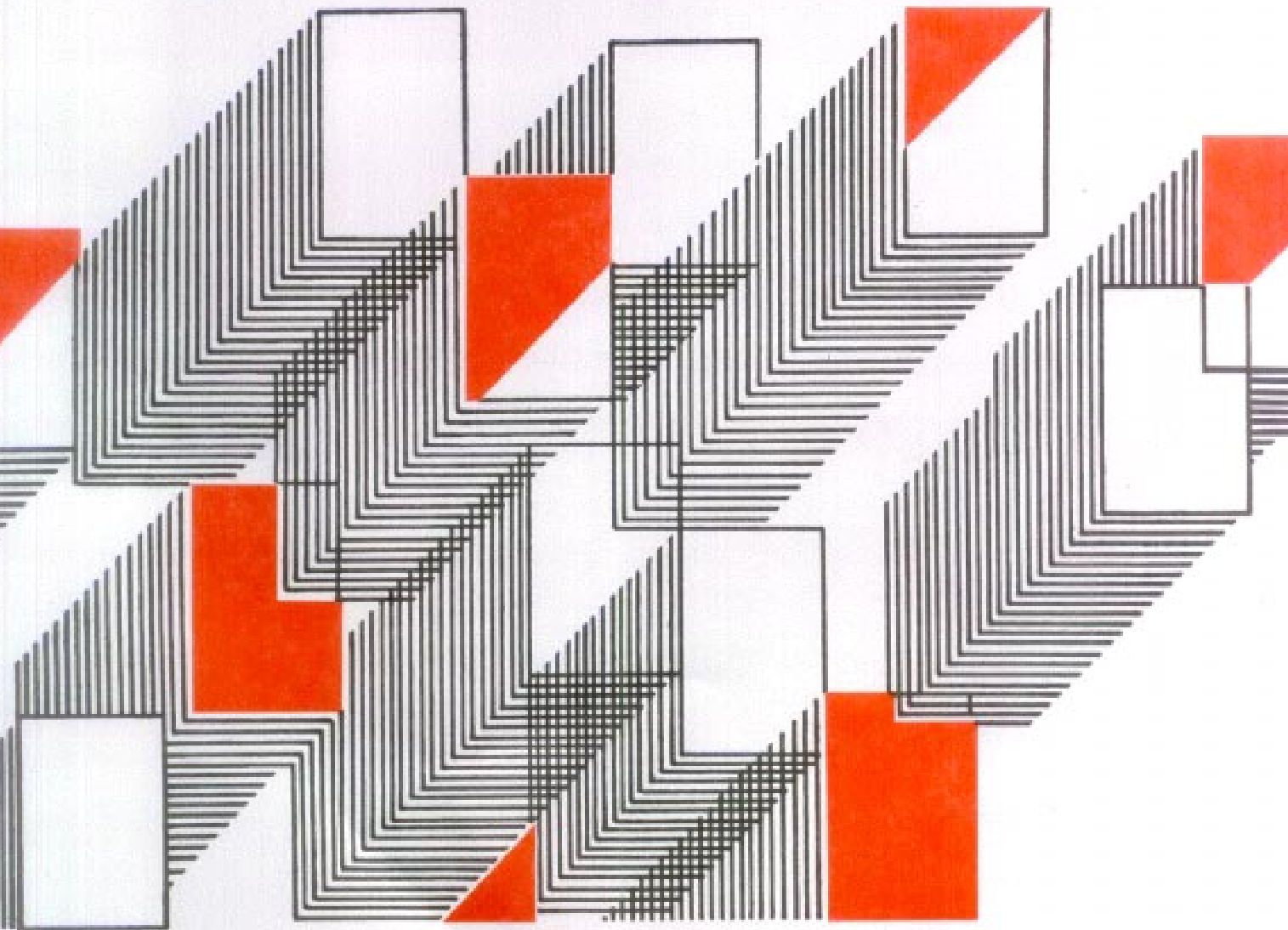
BAR DIAMETER, mm	$f_y = 250 \text{ N/mm}^2$		$f_y = 415 \text{ N/mm}^2$	
	$\alpha = 45^\circ$		$\alpha = 60^\circ$	
	$\alpha = 45^\circ$	$\alpha = 60^\circ$	$\alpha = 45^\circ$	$\alpha = 60^\circ$
10	12.08	14.79	20.05	24.56
12	17.39	21.30	28.87	35.36
16	30.92	37.87	51.33	62.87
18	39.14	47.93	64.97	79.57
20	48.32	59.18	80.21	98.23
22	58.46	71.60	97.05	118.86
25	75.49	92.46	125.32	153.48
28	94.70	115.98	157.20	192.53
32	123.69	151.49	205.32	251.47
36	156.54	191.73	259.86	318.27

 NOTE —  $\alpha$  is the angle between the bent-up bar and the axis of the member.



As in the Original Standard, this Page is Intentionally Left Blank

# DEVELOPMENT LENGTH AND ANCHORAGE



As in the Original Standard, this Page is Intentionally Left Blank

## 5. DEVELOPMENT LENGTH AND ANCHORAGE

### 5.1 DEVELOPMENT LENGTH OF BARS

The development length  $L_d$ , is given by

$$L_d = \frac{\phi \sigma_s}{4 \tau_{bd}}$$

where

$\phi$  is the diameter of the bar,

$\sigma_s$  is the stress in the bar, and

$\tau_{bd}$  is the design bond stress given in 25.2.1.1 of the Code.

The value of the development length corresponding to a stress of  $0.87 f_y$  in the reinforcement, is required for determining the maximum permissible bar diameter for

positive moment reinforcement [see 25.2.3.3(c) of the Code] and for determining the length of lap splices (see 25.2.5.1 of the Code). Values of this development length for different grades of steel and concrete are given in Tables 64 to 66. The tables contain the development length values for bars in tension as well as compression.

### 5.2 ANCHORAGE VALUE OF HOOKS AND BENDS

In the case of bars in tension, a standard hook has an anchorage value equivalent to a straight length of  $16\phi$  and a  $90^\circ$  bend has an anchorage value of  $8\phi$ . The anchorage values of standard hooks and bends for different bar diameters are given in Table 67.

$f_y$   
250  
415  
 $f_{ck}$   
15  
20  
25  
30

TABLE 64 DEVELOPMENT LENGTH FOR FULLY STRESSED PLAIN BARS

$f_y = 250 \text{ N/mm}^2$  for bars up to 20 mm diameter.  
 $= 240 \text{ N/mm}^2$  for bars over 20 mm diameter.

Tabulated values are in centimetres.

BAR DIAMETER, mm	TENSION BARS GRADE OF CONCRETE				COMPRESSION BARS GRADE OF CONCRETE			
	M15	M20	M25	M30	M15	M20	M25	M30
6	32.6	27.2	23.3	21.8	26.1	21.8	18.6	17.4
8	43.5	36.3	31.1	29.0	34.8	29.0	24.9	23.2
10	54.4	45.3	38.8	36.3	43.5	36.3	31.1	29.0
12	65.3	54.4	46.6	43.5	52.2	43.5	37.3	34.8
16	87.0	72.5	62.1	58.0	69.6	58.0	49.7	46.4
18	97.9	81.6	69.9	65.3	78.3	65.3	55.9	52.2
20	108.8	90.6	77.7	72.5	87.0	72.5	62.1	58.0
22	114.8	95.7	82.0	76.6	91.9	76.6	65.6	61.2
25	130.5	108.8	93.2	87.0	104.4	87.0	74.6	69.6
28	146.2	121.8	104.4	97.4	116.9	97.4	83.5	78.0
32	167.0	139.2	119.3	111.4	133.6	111.4	95.5	89.1
36	187.9	156.6	134.2	125.3	150.3	125.3	107.4	100.2

NOTE — The development lengths given above are for a stress of  $0.87 f_y$  in the bar.

TABLE 65 DEVELOPMENT LENGTH FOR FULLY STRESSED DEFORMED BARS

$f_y = 415 \text{ N/mm}^2$

Tabulated values are in centimetres.

BAR DIAMETER, mm	TENSION BARS GRADE OF CONCRETE				COMPRESSION BARS GRADE OF CONCRETE			
	M15	M20	M25	M30	M15	M20	M25	M30
6	33.8	28.2	24.2	22.6	27.1	22.6	19.3	18.1
8	45.1	37.6	32.2	30.1	36.1	30.1	25.8	24.1
10	56.4	47.0	40.3	37.6	45.1	37.6	32.2	30.1
12	67.7	56.4	48.4	45.1	54.2	45.1	38.7	36.1
16	90.3	75.2	64.5	60.2	72.2	60.2	51.6	48.1
18	101.5	84.6	72.5	67.7	81.2	67.7	58.0	54.2
20	112.8	94.0	80.6	75.2	90.3	75.2	64.5	60.2
22	124.1	103.4	88.7	82.7	99.3	82.7	70.9	66.2
25	141.0	117.5	100.7	94.0	112.8	94.0	80.6	75.2
28	158.0	131.6	112.8	105.3	126.4	105.3	90.3	84.2
32	180.5	150.4	128.9	120.3	144.4	120.3	103.2	96.3
36	203.1	169.3	145.0	135.4	162.5	135.4	116.1	108.3

NOTE—The development lengths given above are for a stress of  $0.87 f_y$  in the bars.

TABLE 66 DEVELOPMENT LENGTH FOR FULLY STRESSED DEFORMED BARS

$f_y = 500 \text{ N/mm}^2$

Tabulated values are in centimetres.

BAR DIAMETER, mm	TENSION BARS GRADE OF CONCRETE				COMPRESSION BARS GRADE OF CONCRETE			
	M15	M20	M25	M30	M15	M20	M25	M30
6	40.8	34.0	29.1	27.2	32.6	27.2	23.3	21.8
8	54.4	45.3	38.8	36.3	43.5	36.3	31.1	29.0
10	68.0	56.6	48.5	45.3	54.4	45.3	38.8	36.3
12	81.6	68.0	58.3	54.4	65.3	54.4	46.6	43.5
16	108.8	90.6	77.7	72.5	87.0	72.5	62.1	58.0
18	122.3	102.0	87.4	81.6	97.9	81.6	69.9	65.3
20	135.9	113.3	97.1	90.6	108.8	90.6	77.7	72.5
22	149.5	124.6	106.8	99.7	119.6	99.7	85.4	79.8
25	169.9	141.6	121.4	113.3	135.9	113.3	97.1	90.6
28	190.3	158.6	135.9	126.9	152.3	126.9	108.8	101.5
32	217.5	181.3	155.4	145.0	174.0	145.0	124.3	116.0
36	244.7	203.9	174.8	163.1	195.8	163.1	139.8	130.5

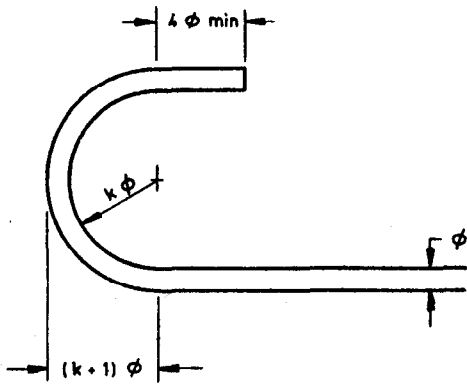
NOTE — The development lengths given above are for a stress of  $0.87 f_y$  in the bar.



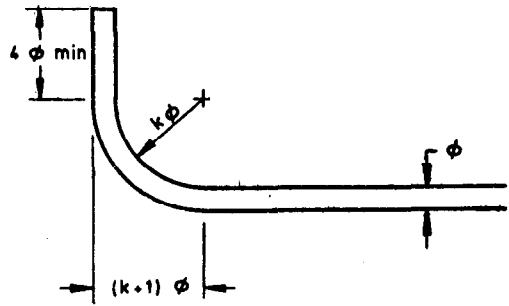
TABLE 67 ANCHORAGE VALUE OF HOOKS AND BENDS

Tabulated values are in centimetres.

BAR DIAMETER, mm	6	8	10	12	16	18	20	22	25	28	32	36
Anchorage Value of hook	9.6	12.8	16.0	19.2	25.6	28.8	32.0	35.2	40.0	44.8	51.2	57.6
Anchorage Value of 90° bend	4.8	6.4	8.0	9.6	12.8	14.4	16.0	17.6	20.0	22.4	25.6	28.8



STANDARD HOOK



STANDARD 90° BEND

STANDARD HOOK AND BEND

*Type of Steel*

Mild steel

Cold worked steel

*Min Value of k*

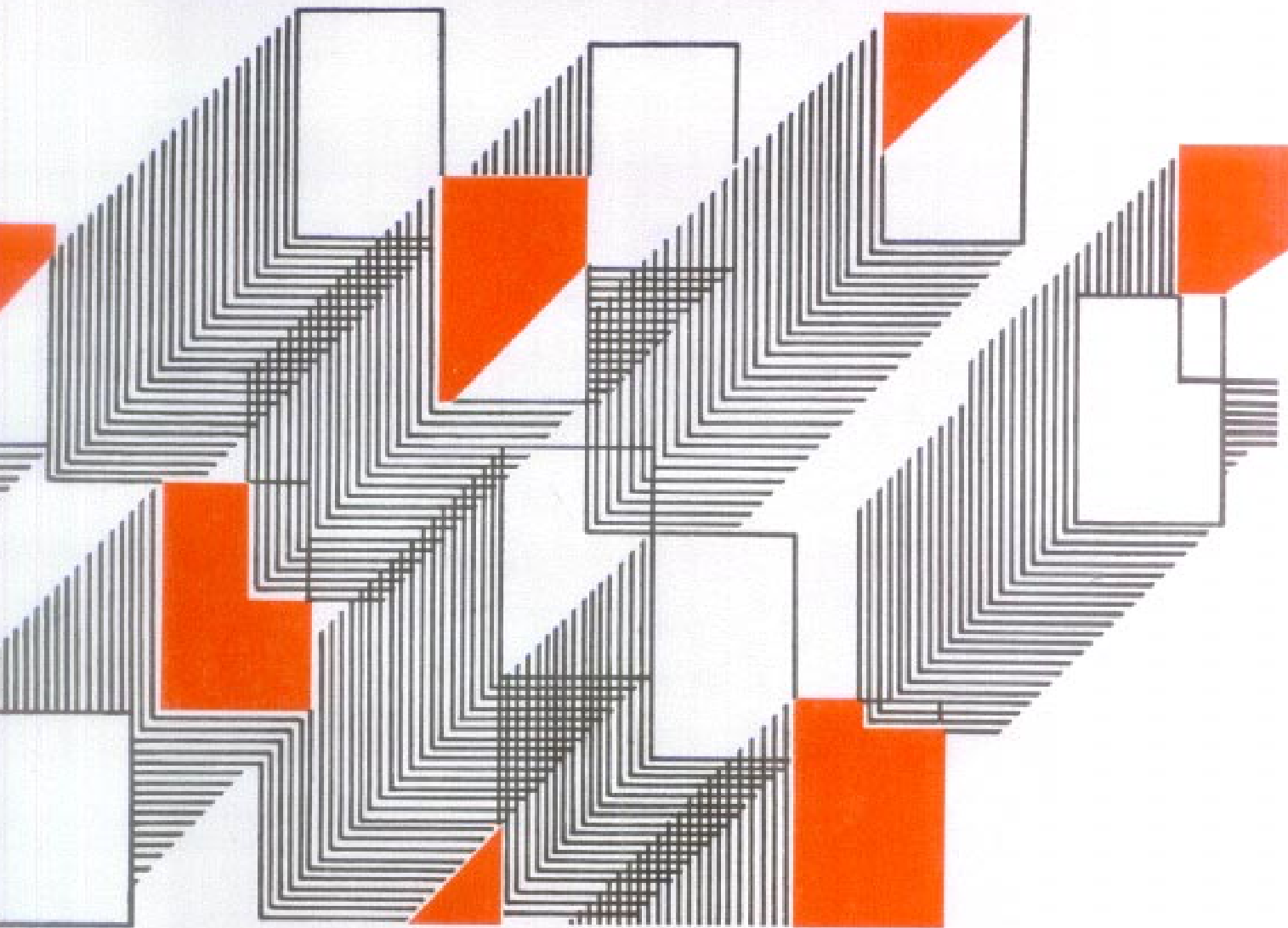
2

4

NOTE 1 — Table is applicable to all grades of reinforcement bars.

NOTE 2 — Hooks and bends shall conform to the details given above.

# WORKING STRESS DESIGN



As in the Original Standard, this Page is Intentionally Left Blank

## 6. WORKING STRESS DESIGN

### 6.1 FLEXURAL MEMBERS

Design of flexural members by working stress method is based on the well known assumptions given in 43.3 of the Code. The value of the modular ratio,  $m$  is given by

$$m = \frac{280}{3 \sigma_{cbc}} = \frac{93.33}{\sigma_{cbc}}$$

Therefore, for all values of  $\sigma_{cbc}$  we have

$$m \sigma_{cbc} = 93.33$$

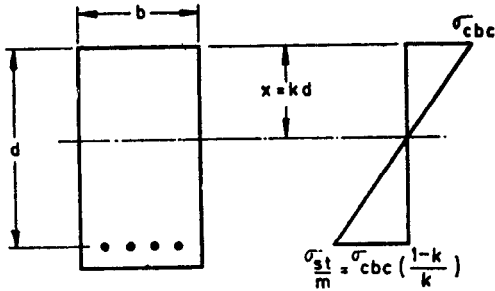


FIG. 9 BALANCED SECTION (WORKING STRESS DESIGN)

#### 6.1.1 Balanced Section (see Fig. 9)

Stress in steel =  $\sigma_{st} = m\sigma_{cbc} \left( \frac{1}{k} - 1 \right)$

$$\left( \frac{1}{k} - 1 \right) = \frac{\sigma_{st}}{m\sigma_{cbc}} = \frac{93.33}{m\sigma_{cbc}}$$

$$\frac{1}{k} = \frac{\sigma_{st}}{93.33} + 1 = \frac{\sigma_{st} + 93.33}{93.33}$$

$$k = \frac{93.33}{\sigma_{st} + 93.33}$$

The value of  $k$  for balanced section depends only on  $\sigma_{st}$ . It is independent of  $\sigma_{cbc}$ . Moment of resistance of a balanced section is given

by  $M_{bal} = \frac{bd^2}{2} \sigma_{cbc} k \left( 1 - \frac{k}{3} \right)$ . The values

of  $M_{bal}/bd^2$  for different values of  $\sigma_{cbc}$  and  $\sigma_{st}$  are given in Table K.

TABLE K MOMENT OF RESISTANCE FACTOR  $M/bd^2$ , N/mm<sup>2</sup> FOR BALANCED RECTANGULAR SECTION

$\sigma_{cbc}$ N/mm <sup>2</sup>	$\sigma_{st}$ , N/mm <sup>2</sup>		
	140	230	275
5.0	0.87	0.65	0.58
7.0	1.21	0.91	0.81
8.5	1.47	1.11	0.99
10.0	1.73	1.30	1.16

Reinforcement percentage  $p_{t,bal}$  for balanced section is determined by equating the compressive force and tensile force.

$$\frac{\sigma_{cbc} kdb}{2} = \frac{p_{t,bal} bd \sigma_{st}}{100}$$

$$p_{t,bal} = \frac{50 k' \sigma_{cbc}}{\sigma_{st}}$$

The value of  $p_{t,bal}$  for different values of  $\sigma_{cbc}$  and  $\sigma_{st}$  are given in Table L.

TABLE L PERCENTAGE OF TENSILE REINFORCEMENT  $p_{t,bal}$  FOR SINGLY REINFORCED BALANCED SECTION (Clause 6.1.1)

$\sigma_{cbc}$ N/mm <sup>2</sup>	$\sigma_{st}$ N/mm <sup>2</sup>		
	140	230	275
5.0	0.71	0.31	0.23
7.0	1.00	0.44	0.32
8.5	1.21	0.53	0.39
10.0	1.43	0.63	0.46

#### 6.1.2 Under Reinforced Section

The position of the neutral axis is found by equating the moments of the equivalent areas.

$$bkd \frac{kd}{2} = \frac{p_t bd}{100} m (d - kd)$$

$$bd^2 \frac{k^2}{2} = bd^2 \frac{p_t m}{100} (1 - k)$$

$$k^2 = \frac{p_t m}{50} (1 - k)$$

$$k^2 + \frac{p_t m k}{50} - \frac{p_t m}{50} = 0.$$

The positive root of this equation is given by

$$k = -\frac{p_t m}{100} + \sqrt{\frac{p_t^2 m^2}{(100)^2} + \frac{p_t m}{50}}$$

This is the general expression for the depth of neutral axis of a singly reinforced section. Moment of resistance of an under-reinforced section is given by

$$M = bd^2 \frac{p_t \sigma_{st}}{100} \left( 1 - \frac{k}{3} \right)$$

Values of the moment of resistance factor  $M/bd^2$  have been tabulated against  $p_t$  in

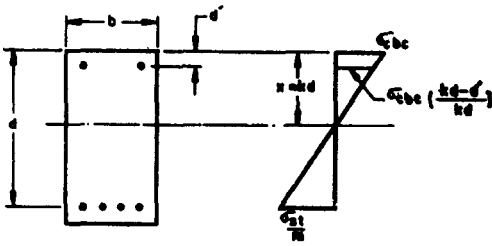


FIG. 10 DOUBLY REINFORCED SECTION (WORKING STRESS DESIGN)

Tables 68 to 71. The Tables cover four grades of concrete and five values of  $\sigma_{st}$ .

6.1.3 *Doubly Reinforced Section*—Doubly reinforced sections are adopted when the bending moment exceeds the moment of resistance of a balanced section.

$$M = M_{bal} + M'$$

The additional moment  $M'$  is resisted by providing compression reinforcement and additional tensile reinforcement. The stress in the compression reinforcement is taken as  $1.5 m$  times the stress in the surrounding concrete.

Taking moment about the centroid of tensile reinforcement,

$$\begin{aligned} M' &= \frac{p_c}{100} bd (1.5 m - 1) \sigma_{cbc} \\ &\quad \times \left( \frac{kd - d'}{kd} \right) (d - d') \\ &= \frac{p_c}{100} (1.5 m - 1) \sigma_{cbc} \\ &\quad \times \left( 1 - \frac{d'}{kd} \right) \left( 1 - \frac{d'}{d} \right) bd^2 \end{aligned}$$

Equating the additional tensile force and additional compressive force,

$$\begin{aligned} bd \frac{(p_t - p_{t,bal})}{100} \sigma_{st} \\ &= \frac{p_c}{100} (1.5 m - 1) \sigma_{cbc} \left( 1 - \frac{d'}{kd} \right) \\ &\text{OR } (p_t - p_{t,bal}) \sigma_{st} \\ &= p_c (1.5 m - 1) \sigma_{cbc} \left( 1 - \frac{d'}{kd} \right) \end{aligned}$$

$$\begin{aligned} \therefore M &= M_{bal} + \frac{(p_t - p_{t,bal})}{100} \sigma_{st} \\ &\quad \times \left( 1 - \frac{d'}{d} \right) bd^2 \end{aligned}$$

Total tensile reinforcement  $A_{st}$  is given by

$$A_{st} = A_{st1} + A_{st2}$$

where  $A_{st1} = p_{t,bal} \frac{bd}{100}$

and  $A_{st2} = \frac{M'}{\sigma_{st} (d - d')}$

The compression reinforcement can be expressed as a ratio of the additional tensile reinforcement area  $A_{st2}$ .

$$\begin{aligned} \frac{A_{sc}}{A_{st2}} &= \frac{p_c}{(p_t - p_{t,bal})} \\ &= \frac{\sigma_{st}}{\sigma_{cbc}} \frac{1}{(1.5 m - 1) (1 - d'/kd)} \end{aligned}$$

Values of this ratio have been tabulated for different values of  $d'/d$  and  $\sigma_{cbc}$  in Table M. The table includes two values of  $\sigma_{st}$ . The values of  $p_t$  and  $p_c$  for four values of  $d'/d$  have been tabulated against  $M/bd^2$  in Tables 72 to 79. Tables are given for four grades of concrete and two grades of steel.

TABLE M VALUES OF THE RATIO  $A_{sc}/A_{st2}$  (Clause 6.1.3)

$\sigma_{st}$ N/mm <sup>2</sup>	$\sigma_{cbc}$ N/mm <sup>2</sup>	$d'/d$				
		0.05	0.10	0.15	0.20	
140	5.0	1.19	1.38	1.66	2.07	
		7.0	1.20	1.40	1.68	2.11
		8.5	1.22	1.42	1.70	2.13
		10.0	1.23	1.44	1.72	2.15
230	5.0	2.06	2.61	3.55	5.54	
		7.0	2.09	2.65	3.60	5.63
		8.5	2.12	2.68	3.64	5.69
		10.0	2.14	2.71	3.68	5.76

## 6.2 COMPRESSION MEMBERS

Charts 86 and 87 are given for determining the permissible axial load on a pedestal or short column reinforced with longitudinal bars and lateral ties. Charts are given for two values of  $\sigma_{sc}$ . These charts have been made in accordance with 45.1 of the Code.

According to 46.3 of the Code, members subject to combined axial load and bending designed by methods based on elastic theory should be further checked for their strength under ultimate load conditions. Therefore it would be advisable to design such members directly by the limit state method. Hence, no design aids are given for designing such members by elastic theory.

### 6.3 SHEAR AND TORSION

The method of design for shear and torsion by working stress method are similar to the limit state method. The values of permissible shear stress in concrete are given in *Table 80*.

*Tables 81 and 82* are given for design of shear reinforcement.

### 6.4 DEVELOPMENT LENGTH AND ANCHORAGE

The method of calculating development length is the same as given under limit state design. The difference is only in the values of bond stresses. Development lengths for plain bars and two grades of deformed bars are given in *Tables 83 to 85*.

Anchorage value of standard hooks and bends as given in *Table 67* are applicable to working stress method also.



As in the Original Standard, this Page is Intentionally Left Blank

Chart 86 AXIAL COMPRESSION (Working Stress Design)

$\sigma_{sc} = 130 \text{ N/mm}^2$

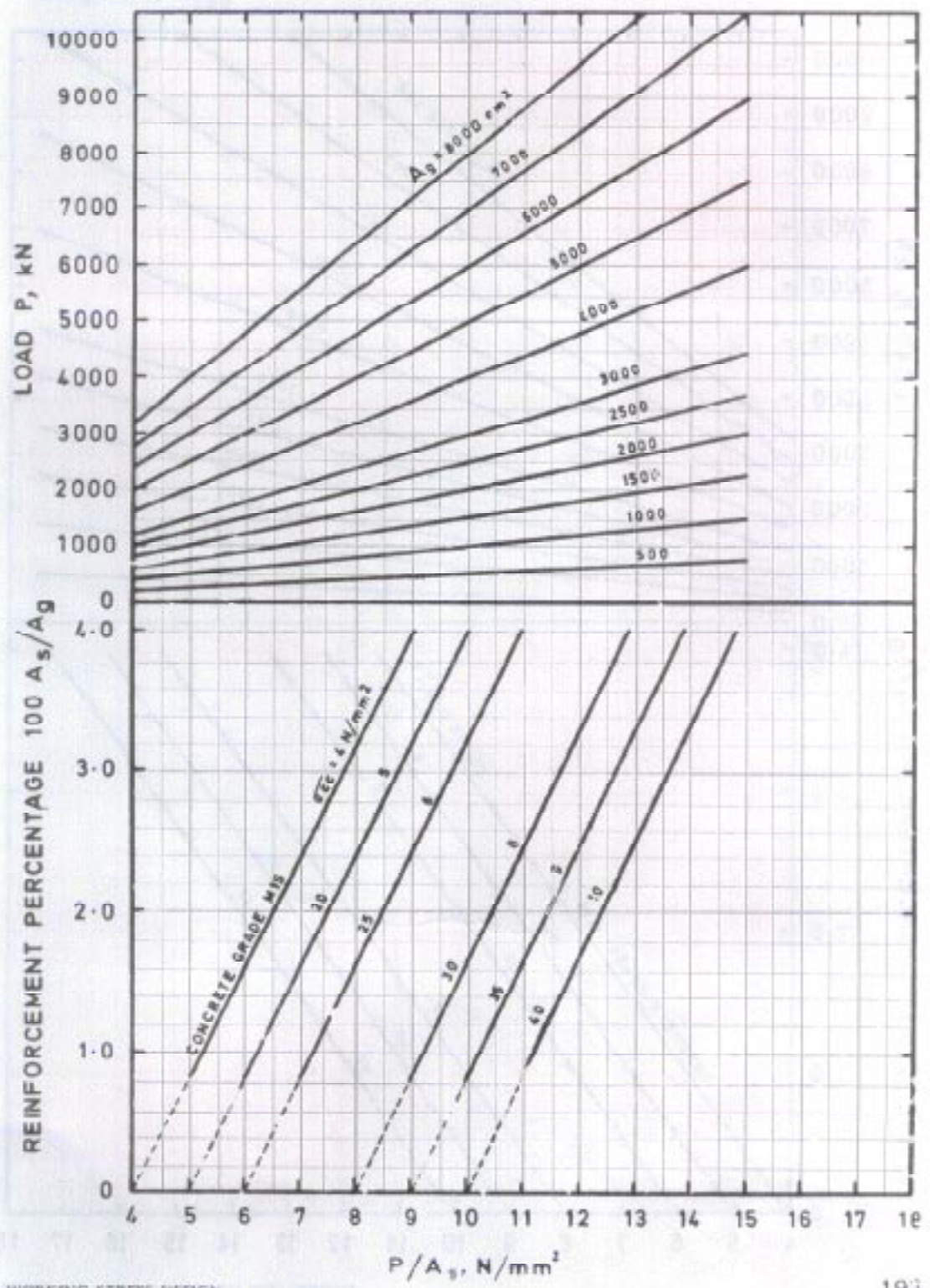
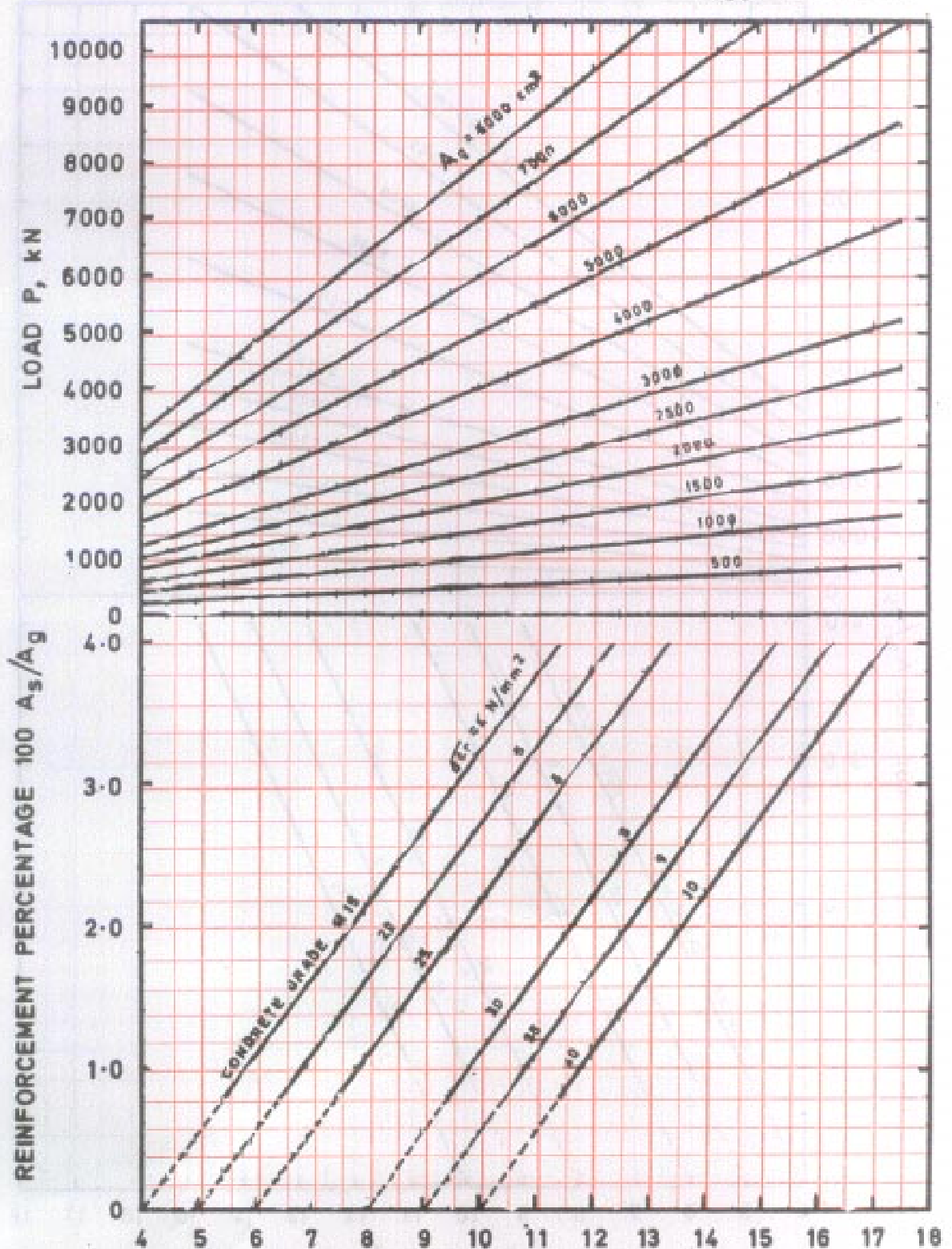


Chart 87 AXIAL COMPRESSION (Working Stress Design)

$\sigma_{sc} = 190 \text{ N/mm}^2$



WORKING STRESS METHOD

$\sigma_{st}$   
 130  
 140  
 190  
 230  
 275  


---

 $\sigma_{cbc}$   
 5.0

TABLE 68 FLEXURE — MOMENT OF RESISTANCE FACTOR,  $M/bd^2$ ,  $N/mm^2$  FOR SINGLY REINFORCED SECTIONS

$P_t$	$\sigma_{st}, N/mm^2$					$P_t$	$\sigma_{st}, N/mm^2$				
	130	140	190	230	275		130	140	190	230	275
0.12	0.146	0.157	0.214	0.258	0.309	0.47	0.542	0.583			
0.13	0.158	0.170	0.231	0.279	0.334	0.48	0.553	0.595			
0.14	0.170	0.183	0.248	0.300	0.359	0.49	0.564	0.607			
0.15	0.181	0.195	0.265	0.321	0.384	0.50	0.574	0.619			
0.16	0.193	0.208	0.282	0.341	0.408	0.51	0.585	0.630			
0.17	0.205	0.220	0.299	0.362	0.433	0.52	0.596	0.642			
0.18	0.216	0.233	0.316	0.383	0.457	0.53	0.607	0.654			
0.19	0.228	0.245	0.333	0.403	0.482	0.54	0.618	0.665			
0.20	0.239	0.258	0.350	0.423	0.506	0.55	0.629	0.677			
0.21	0.251	0.270	0.367	0.444	0.531	0.56	0.640	0.689			
0.22	0.262	0.282	0.383	0.464	0.555	0.57	0.650	0.700			
0.23	0.274	0.295	0.400	0.484	0.579	0.58	0.661	0.712			
0.24	0.285	0.307	0.417	0.505		0.59	0.672	0.724			
0.25	0.297	0.319	0.433	0.525		0.60	0.683	0.735			
0.26	0.308	0.332	0.450	0.545		0.61	0.693	0.747			
0.27	0.319	0.344	0.467	0.565		0.62	0.704	0.758			
0.28	0.331	0.356	0.483	0.585		0.63	0.715	0.770			
0.29	0.342	0.368	0.500	0.605		0.64	0.726	0.781			
0.30	0.353	0.380	0.516	0.625		0.65	0.736	0.793			
0.31	0.364	0.392	0.533	0.645		0.66	0.747	0.804			
0.32	0.376	0.405	0.549			0.67	0.758	0.816			
0.33	0.387	0.417	0.565			0.68	0.768	0.827			
0.34	0.398	0.429	0.582			0.69	0.779	0.839			
0.35	0.409	0.441	0.598			0.70	0.790	0.850			
0.36	0.420	0.453	0.614			0.71	0.800	0.862			
0.37	0.431	0.465	0.631			0.72	0.811				
0.38	0.443	0.477	0.647			0.73	0.821				
0.39	0.454	0.489	0.663			0.74	0.832				
0.40	0.465	0.500	0.679			0.75	0.843				
0.41	0.476	0.512	0.695			0.76	0.853				
0.42	0.487	0.524	0.711			0.77	0.864				
0.43	0.498	0.536	0.728			0.78	0.874				
0.44	0.509	0.548				0.79	0.885				
0.45	0.520	0.560				0.80	0.895				
0.46	0.531	0.572									

$\sigma_{st}$   
 130  
 140  
 190  
 230  
 275  


---

 $\sigma_{cbc}$   
 7.0

WORKING STRESS METHOD

TABLE 69 FLEXURE — MOMENT OF RESISTANCE FACTOR,  $M/bd^2$ ,  $N/mm^2$  FOR SINGLY REINFORCED SECTIONS

$\sigma_{cbc} = 7.0 \text{ N/mm}^2$

$P_t$	$\sigma_{st}, \text{N/mm}^2$					$P_t$	$\sigma_{st}, \text{N/mm}^2$				
	130	140	190	230	275		130	140	190	230	275
0.20	0.242	0.261	0.354	0.428	0.512	0.76	0.869	0.936			
0.22	0.266	0.286	0.388	0.470	0.562	0.77	0.880	0.948			
0.24	0.289	0.311	0.422	0.511	0.611	0.78	0.891	0.960			
0.26	0.312	0.336	0.456	0.552	0.660	0.79	0.902	0.971			
0.28	0.335	0.361	0.490	0.593	0.709	0.80	0.913	0.983			
0.30	0.358	0.386	0.523	0.633	0.757	0.81	0.923	0.994			
0.32	0.381	0.410	0.557	0.674	0.806	0.82	0.934	1.006			
0.34	0.404	0.435	0.590	0.714		0.83	0.945	1.018			
0.36	0.427	0.459	0.623	0.755		0.84	0.956	1.029			
0.38	0.449	0.484	0.657	0.795		0.85	0.966	1.041			
0.40	0.472	0.508	0.690	0.835		0.86	0.977	1.052			
0.42	0.494	0.532	0.723	0.875		0.87	0.988	1.064			
0.43	0.506	0.545	0.739	0.895		0.88	0.999	1.075			
0.44	0.517	0.557	0.756			0.89	1.009	1.087			
0.45	0.528	0.569	0.772			0.90	1.020	1.099			
0.46	0.539	0.581	0.788			0.91	1.031	1.110			
0.47	0.551	0.593	0.805			0.92	1.041	1.122			
0.48	0.562	0.605	0.821			0.93	1.052	1.133			
0.49	0.573	0.617	0.837			0.94	1.063	1.145			
0.50	0.584	0.629	0.854			0.95	1.073	1.156			
0.51	0.595	0.641	0.870			0.96	1.084	1.168			
0.52	0.606	0.653	0.886			0.97	1.095	1.179			
0.53	0.617	0.665	0.902			0.98	1.105	1.190			
0.54	0.628	0.677	0.919			0.99	1.116	1.202			
0.55	0.640	0.689	0.935			1.00	1.127				
0.56	0.651	0.701	0.951			1.01	1.137				
0.57	0.662	0.713	0.967			1.02	1.148				
0.58	0.673	0.724	0.983			1.03	1.158				
0.59	0.684	0.736	0.999			1.04	1.169				
0.60	0.695	0.748	1.015			1.05	1.180				
0.61	0.706	0.760				1.06	1.190				
0.62	0.717	0.772				1.07	1.201				
0.63	0.728	0.784				1.08	1.211				
0.64	0.739	0.795				1.09	1.222				
0.65	0.750	0.807				1.10	1.232				
0.66	0.761	0.819				1.11	1.243				
0.67	0.772	0.831				1.12	1.254				
0.68	0.782	0.843				1.13	1.264				
0.69	0.793	0.854									
0.70	0.804	0.866									
0.71	0.815	0.878									
0.72	0.826	0.890									
0.73	0.837	0.901									
0.74	0.848	0.913									
0.75	0.859	0.925									

WORKING STRESS METHOD

$\sigma_{st}$   
 130  
 140  
 190  
 230  
 275  


---

 $\sigma_{cbc}$   
 8.5

TABLE 70 FLEXURE — MOMENT OF RESISTANCE FACTOR,  $M/bd^2$ ,  $N/mm^2$  FOR SINGLY REINFORCED SECTIONS

$\sigma_{cbc} = 8.5 N/mm^2$

$P_t$	$\sigma_{st}, N/mm^2$					$P_t$	$\sigma_{st}, N/mm^2$				
	130	140	190	230	275		130	140	190	230	275
0.20	0.244	0.262	0.356	0.431	0.515	0.96	1.096	1.180			
0.22	0.267	0.288	0.391	0.473	0.565	0.97	1.107	1.192			
0.24	0.291	0.313	0.425	0.514	0.615	0.98	1.117	1.203			
0.26	0.314	0.338	0.459	0.556	0.664	0.99	1.128	1.215			
0.28	0.337	0.363	0.493	0.597	0.714	1.00	1.139	1.227			
0.30	0.361	0.388	0.527	0.638	0.763	1.01	1.150	1.238			
0.32	0.394	0.413	0.561	0.679	0.812	1.02	1.161	1.250			
0.34	0.407	0.438	0.595	0.720	0.861	1.03	1.171	1.261			
0.36	0.430	0.463	0.628	0.761	0.909	1.04	1.182	1.273			
0.38	0.453	0.488	0.662	0.801	0.958	1.05	1.193	1.285			
0.40	0.476	0.512	0.695	0.842		1.06	1.203	1.296			
0.42	0.498	0.537	0.729	0.882		1.07	1.214	1.308			
0.44	0.521	0.561	0.762	0.922		1.08	1.225	1.319			
0.46	0.544	0.586	0.795	0.962		1.09	1.236	1.331			
0.48	0.567	0.610	0.828	1.002		1.10	1.246	1.342			
0.50	0.589	0.634	0.861	1.042		1.11	1.257	1.354			
0.52	0.612	0.659	0.894	1.082		1.12	1.268	1.365			
0.54	0.634	0.683	0.927			1.13	1.278	1.377			
0.56	0.657	0.707	0.960			1.14	1.289	1.388			
0.58	0.679	0.731	0.992			1.15	1.300	1.400			
0.60	0.701	0.755	1.025			1.16	1.310	1.411			
0.62	0.723	0.779	1.057			1.17	1.321	1.423			
0.64	0.746	0.803	1.090			1.18	1.332	1.434			
0.66	0.768	0.827	1.122			1.19	1.342	1.446			
0.68	0.790	0.851	1.155			1.20	1.353	1.457			
0.70	0.812	0.875	1.187			1.21	1.364	1.468			
0.72	0.834	0.898	1.219			1.22	1.374				
0.74	0.856	0.922				1.23	1.385				
0.76	0.878	0.946				1.24	1.395				
0.78	0.900	0.969				1.25	1.406				
0.80	0.922	0.993				1.26	1.417				
0.82	0.944	1.016				1.27	1.427				
0.83	0.955	1.028				1.28	1.438				
0.84	0.966	1.040				1.29	1.448				
0.85	0.977	1.052				1.30	1.459				
0.86	0.987	1.063				1.31	1.469				
0.87	0.998	1.075				1.32	1.480				
0.88	1.009	1.087				1.33	1.491				
0.89	1.020	1.099				1.34	1.501				
0.90	1.031	1.110				1.35	1.512				
0.91	1.042	1.122				1.36	1.522				
0.92	1.053	1.134				1.37	1.533				
0.93	1.063	1.145									
0.94	1.074	1.157									
0.95	1.085	1.169									



$\sigma_{st}$   
130  
140  
190  
230  
275  
 $\sigma_{cbc}$   
10.0

WORKING STRESS METHOD

TABLE 71 FLEXURE — MOMENT OF RESISTANCE FACTOR,  $M/bd^2$ , N/mm<sup>2</sup> FOR SINGLY REINFORCED SECTIONS

$\sigma_{cbc} = 10.0 \text{ N/mm}^2$

$P_t$	$\sigma_{st}, \text{N/mm}^2$					$P_t$	$\sigma_{st}, \text{N/mm}^2$				
	130	140	190	230	275		130	140	190	230	275
0.20	0.245	0.264	0.358	0.433	0.518	1.10	1.257	1.354			
0.22	0.269	0.289	0.392	0.475	0.568	1.12	1.279	1.377			
0.24	0.292	0.315	0.427	0.517	0.618	1.14	1.301	1.401			
0.26	0.316	0.340	0.461	0.559	0.668	1.16	1.322	1.424			
0.28	0.339	0.365	0.496	0.600	0.718	1.18	1.344	1.447			
0.30	0.363	0.391	0.530	0.642	0.767	1.20	1.365	1.470			
0.32	0.386	0.416	0.564	0.683	0.817	1.22	1.387	1.494			
0.34	0.409	0.441	0.598	0.724	0.866	1.24	1.408	1.517			
0.36	0.432	0.466	0.632	0.765	0.915	1.26	1.430	1.540			
0.38	0.456	0.491	0.666	0.806	0.964	1.28	1.451	1.563			
0.40	0.479	0.515	0.700	0.847	1.013	1.30	1.473	1.586			
0.42	0.502	0.540	0.733	0.888	1.061	1.31	1.483	1.597			
0.44	0.525	0.565	0.767	0.928	1.110	1.32	1.494	1.609			
0.46	0.548	0.590	0.800	0.969	1.158	1.33	1.505	1.620			
0.48	0.570	0.614	0.834	1.009		1.34	1.515	1.632			
0.50	0.593	0.639	0.867	1.049		1.35	1.526	1.643			
0.52	0.616	0.663	0.900	1.090		1.36	1.537	1.655			
0.54	0.639	0.688	0.933	1.130		1.37	1.547	1.666			
0.56	0.661	0.712	0.966	1.170		1.38	1.558	1.678			
0.58	0.684	0.736	0.999	1.210		1.39	1.569	1.689			
0.60	0.706	0.761	1.032	1.250		1.40	1.579	1.701			
0.62	0.729	0.785	1.065	1.289		1.41	1.590	1.712			
0.64	0.751	0.809	1.098			1.42	1.600	1.724			
0.66	0.774	0.833	1.131			1.43	1.611				
0.68	0.796	0.857	1.163			1.44	1.622				
0.70	0.818	0.881	1.196			1.45	1.632				
0.72	0.841	0.905	1.229			1.46	1.643				
0.74	0.863	0.929	1.261			1.47	1.653				
0.76	0.885	0.953	1.294			1.48	1.664				
0.78	0.907	0.977	1.326			1.49	1.675				
0.80	0.929	1.001	1.358			1.50	1.685				
0.82	0.952	1.025	1.391			1.51	1.696				
0.84	0.974	1.048	1.423			1.52	1.706				
0.86	0.996	1.072	1.455			1.53	1.717				
0.88	1.018	1.096				1.54	1.727				
0.90	1.040	1.120				1.55	1.738				
0.92	1.062	1.143				1.56	1.749				
0.94	1.083	1.167				1.57	1.759				
0.96	1.105	1.190				1.58	1.770				
0.98	1.127	1.214				1.59	1.780				
1.00	1.149	1.237				1.60	1.791				
1.02	1.171	1.261									
1.04	1.192	1.284									
1.06	1.214	1.308									
1.08	1.236	1.331									

$\sigma_{st}$   
 140  
 $\sigma_{cbc}$   
 5.0

## WORKING STRESS METHOD

TABLE 72 FLEXURE—REINFORCEMENT PERCENTAGES FOR DOUBLY REINFORCED SECTIONS

 $\sigma_{cbc} = 5.0 \text{ N/mm}^2$   
 $\sigma_{st} = 140 \text{ N/mm}^2$ 

$M/bd^2$ , $\text{N/mm}^2$	$d'/d = 0.05$		$d'/d = 0.10$		$d'/d = 0.15$		$d'/d = 0.20$	
	$P_t$	$P_c$	$P_t$	$P_c$	$P_t$	$P_c$	$P_t$	$P_c$
0.87	0.717	0.003	0.717	0.004	0.717	0.005	0.717	0.006
0.90	0.739	0.030	0.741	0.037	0.742	0.046	0.744	0.062
0.95	0.777	0.070	0.780	0.091	0.784	0.116	0.789	0.154
1.00	0.815	0.119	0.820	0.146	0.826	0.186	0.833	0.247
1.05	0.852	0.163	0.860	0.201	0.868	0.256	0.878	0.340
1.10	0.890	0.208	0.899	0.256	0.910	0.325	0.923	0.432
1.15	0.927	0.252	0.939	0.311	0.952	0.395	0.967	0.525
1.20	0.965	0.297	0.979	0.366	0.994	0.465	1.012	0.617
1.25	1.003	0.342	1.019	0.421	1.036	0.534	1.057	0.710
1.30	1.040	0.386	1.058	0.476	1.078	0.604	1.101	0.802
1.35	1.078	0.431	1.098	0.530	1.120	0.674	1.146	0.895
1.40	1.115	0.475	1.138	0.585	1.162	0.744	1.190	0.988
1.45	1.153	0.520	1.177	0.640	1.204	0.813	1.235	1.080
1.50	1.190	0.564	1.217	0.695	1.247	0.883	1.280	1.173
1.55	1.228	0.609	1.257	0.750	1.289	0.953	1.324	1.265
1.60	1.266	0.653	1.296	0.805	1.331	1.023	1.369	1.358
1.65	1.303	0.698	1.336	0.860	1.373	1.092	1.414	1.451
1.70	1.341	0.743	1.376	0.914	1.415	1.162	1.458	1.543
1.75	1.378	0.787	1.415	0.969	1.457	1.232	1.503	1.636
1.80	1.416	0.832	1.455	1.024	1.499	1.301	1.548	1.728
1.85	1.454	0.876	1.495	1.079	1.541	1.371	1.592	1.821
1.90	1.491	0.921	1.534	1.134	1.583	1.441	1.637	1.914
1.95	1.529	0.965	1.574	1.189	1.625	1.511	1.682	2.006
2.00	1.566	1.010	1.614	1.244	1.667	1.580	1.726	2.099
2.05	1.604	1.054	1.653	1.299	1.709	1.650	1.771	2.191
2.10	1.642	1.099	1.693	1.353	1.751	1.720	1.815	2.284
2.15	1.679	1.144	1.733	1.408	1.793	1.789	1.860	2.377
2.20	1.717	1.188	1.772	1.463	1.835	1.859	1.905	2.469
2.25	1.754	1.233	1.812	1.518	1.877	1.929	1.949	2.562
2.30	1.792	1.277	1.852	1.573	1.919	1.999	1.994	2.654
2.35	1.830	1.322	1.892	1.628	1.961	2.068	2.039	2.747
2.40	1.867	1.366	1.931	1.683	2.003	2.138	2.083	2.840
2.45	1.905	1.411	1.971	1.738	2.045	2.208	2.128	2.932
2.50	1.942	1.455	2.011	1.792	2.087	2.277	2.173	3.025
2.55	1.980	1.500	2.050	1.847	2.129	2.347	2.217	3.117
2.60	2.018	1.545	2.090	1.902	2.171	2.417	2.262	3.210
2.65	2.055	1.589	2.130	1.957	2.213	2.487	2.307	3.302
2.70	2.093	1.634	2.169	2.012	2.255	2.556	2.351	3.395
2.75	2.130	1.678	2.209	2.067	2.297	2.626	2.396	3.488
2.80	2.168	1.723	2.249	2.122	2.339	2.696	2.440	3.580
2.85	2.206	1.767	2.288	2.177	2.381	2.765	2.485	3.673
2.90	2.243	1.812	2.328	2.231	2.423	2.835	2.530	3.765
2.95	2.281	1.857	2.368	2.286	2.465	2.905	2.574	3.858
3.00	2.318	1.901	2.407	2.341	2.507	2.975	2.619	3.951
3.05	2.356	1.946	2.447	2.396	2.549	3.044	2.664	4.043

$\sigma_{st}$   
140  
 $\sigma_{cbc}$   
7.0

WORKING STRESS METHOD

TABLE 73 FLEXURE — REINFORCEMENT PERCENTAGES FOR DOUBLY REINFORCED SECTIONS

$\sigma_{cbc} = 7.0 \text{ N/mm}^2$   
 $\sigma_{st} = 140 \text{ N/mm}^2$

$M_u/bd^2$ N/mm <sup>2</sup>	$d'/d = 0.05$		$d'/d = 0.10$		$d'/d = 0.15$		$d'/d = 0.20$	
	$P_t$	$P_c$	$P_t$	$P_c$	$P_t$	$P_c$	$P_t$	$P_c$
1.22	1.005	0.006	1.005	0.007	1.006	0.009	1.006	0.013
1.25	1.028	0.033	1.029	0.041	1.031	0.052	1.033	0.069
1.30	1.065	0.078	1.069	0.097	1.073	0.123	1.077	0.163
1.35	1.103	0.124	1.108	0.152	1.115	0.193	1.122	0.257
1.40	1.140	0.169	1.148	0.208	1.157	0.264	1.167	0.351
1.45	1.178	0.214	1.188	0.264	1.199	0.335	1.211	0.445
1.50	1.216	0.259	1.228	0.319	1.241	0.406	1.255	0.539
1.55	1.253	0.305	1.267	0.375	1.283	0.476	1.301	0.633
1.60	1.291	0.350	1.307	0.431	1.325	0.547	1.345	0.727
1.65	1.328	0.395	1.347	0.486	1.367	0.618	1.390	0.821
1.70	1.366	0.440	1.386	0.542	1.409	0.689	1.435	0.915
1.75	1.404	0.485	1.426	0.598	1.451	0.760	1.479	1.009
1.80	1.441	0.531	1.466	0.653	1.493	0.830	1.524	1.103
1.85	1.479	0.576	1.505	0.709	1.535	0.901	1.568	1.197
1.90	1.516	0.621	1.545	0.765	1.577	0.972	1.613	1.291
1.95	1.554	0.666	1.585	0.821	1.619	1.043	1.658	1.385
2.00	1.591	0.712	1.624	0.876	1.661	1.113	1.702	1.479
2.05	1.629	0.757	1.664	0.932	1.703	1.184	1.747	1.573
2.10	1.667	0.802	1.704	0.988	1.745	1.255	1.792	1.667
2.15	1.704	0.847	1.743	1.043	1.787	1.326	1.836	1.761
2.20	1.742	0.892	1.783	1.099	1.829	1.396	1.881	1.855
2.25	1.779	0.938	1.823	1.155	1.871	1.467	1.926	1.949
2.30	1.817	0.983	1.862	1.210	1.913	1.538	1.970	2.043
2.35	1.855	1.028	1.902	1.266	1.955	1.609	2.015	2.137
2.40	1.892	1.073	1.942	1.322	1.997	1.680	2.060	2.231
2.45	1.930	1.119	1.981	1.378	2.039	1.750	2.104	2.325
2.50	1.967	1.164	2.021	1.433	2.081	1.821	2.149	2.419
2.55	2.005	1.209	2.061	1.489	2.123	1.892	2.193	2.513
2.60	2.043	1.254	2.101	1.545	2.165	1.963	2.238	2.607
2.65	2.080	1.299	2.140	1.600	2.207	2.033	2.283	2.701
2.70	2.118	1.345	2.180	1.656	2.249	2.104	2.327	2.795
2.75	2.155	1.390	2.220	1.712	2.291	2.175	2.372	2.888
2.80	2.193	1.435	2.259	1.767	2.333	2.246	2.417	2.982
2.85	2.231	1.480	2.299	1.823	2.375	2.316	2.461	3.076
2.90	2.268	1.526	2.339	1.879	2.417	2.387	2.506	3.170
2.95	2.306	1.571	2.378	1.934	2.459	2.458	2.551	3.264
3.00	2.343	1.616	2.418	1.990	2.501	2.529	2.595	3.358
3.05	2.381	1.661	2.458	2.046	2.543	2.599	2.640	3.452
3.10	2.419	1.707	2.497	2.102	2.585	2.670	2.685	3.546
3.15	2.456	1.752	2.537	2.157	2.627	2.741	2.729	3.640
3.20	2.494	1.797	2.577	2.213	2.669	2.812	2.774	3.734
3.25	2.531	1.842	2.616	2.269	2.711	2.883	2.818	3.828
3.30	2.569	1.887	2.656	2.324	2.754	2.953	2.863	3.922
3.35	2.607	1.933	2.696	2.380	2.796	3.024	2.908	4.016
3.40	2.644	1.978	2.735	2.436	2.838	3.095	2.952	4.110

## WORKING STRESS METHOD

TABLE 74 FLEXURE—REINFORCEMENT PERCENTAGES FOR DOUBLY REINFORCED SECTIONS

$\sigma_{cbc} = 8.5 \text{ N/mm}^2$   
 $\sigma_{st} = 140 \text{ N/mm}^2$

$M/bd^2$ , $\text{N/mm}^2$	$d'/d = 0.05$		$d'/d = 0.10$		$d'/d = 0.15$		$d'/d = 0.20$	
	$P_t$	$P_c$	$P_t$	$P_c$	$P_t$	$P_c$	$P_t$	$P_c$
1.48	1.219	0.006	1.220	0.008	1.220	0.010	1.220	0.013
1.50	1.234	0.024	1.235	0.030	1.237	0.038	1.238	0.051
1.55	1.272	0.070	1.275	0.086	1.279	0.110	1.283	0.146
1.60	1.310	0.116	1.315	0.143	1.321	0.181	1.327	0.241
1.65	1.347	0.162	1.354	0.199	1.363	0.253	1.372	0.336
1.70	1.385	0.207	1.394	0.255	1.405	0.324	1.417	0.431
1.75	1.422	0.253	1.434	0.312	1.447	0.396	1.461	0.526
1.80	1.460	0.299	1.474	0.368	1.489	0.468	1.506	0.621
1.85	1.497	0.345	1.513	0.424	1.531	0.539	1.551	0.716
1.90	1.535	0.390	1.553	0.481	1.573	0.611	1.595	0.811
1.95	1.573	0.436	1.593	0.537	1.615	0.682	1.640	0.906
2.00	1.610	0.482	1.632	0.593	1.657	0.754	1.685	1.001
2.05	1.648	0.528	1.672	0.650	1.699	0.825	1.729	1.096
2.10	1.685	0.573	1.712	0.706	1.741	0.897	1.774	1.191
2.15	1.723	0.619	1.751	0.762	1.783	0.969	1.818	1.286
2.20	1.761	0.665	1.791	0.819	1.825	1.040	1.863	1.382
2.25	1.798	0.711	1.831	0.875	1.867	1.112	1.908	1.477
2.30	1.836	0.756	1.870	0.931	1.909	1.183	1.952	1.572
2.35	1.873	0.802	1.910	0.988	1.951	1.255	1.997	1.667
2.40	1.911	0.848	1.950	1.044	1.993	1.326	2.042	1.762
2.45	1.949	0.893	1.989	1.100	2.035	1.398	2.086	1.857
2.50	1.986	0.939	2.029	1.157	2.077	1.470	2.131	1.952
2.55	2.024	0.985	2.069	1.213	2.119	1.541	2.176	2.047
2.60	2.061	1.031	2.108	1.269	2.161	1.613	2.220	2.142
2.65	2.099	1.076	2.148	1.326	2.203	1.684	2.265	2.237
2.70	2.137	1.122	2.188	1.382	2.245	1.756	2.310	2.332
2.75	2.174	1.168	2.228	1.438	2.287	1.827	2.354	2.427
2.80	2.212	1.214	2.267	1.495	2.329	1.899	2.399	2.522
2.85	2.249	1.259	2.307	1.551	2.371	1.971	2.443	2.617
2.90	2.287	1.305	2.347	1.607	2.413	2.042	2.488	2.712
2.95	2.325	1.351	2.386	1.664	2.455	2.114	2.533	2.807
3.00	2.362	1.397	2.426	1.720	2.497	2.185	2.577	2.902
3.05	2.400	1.442	2.466	1.776	2.539	2.257	2.622	2.997
3.10	2.437	1.488	2.505	1.833	2.581	2.329	2.667	3.093
3.15	2.475	1.534	2.545	1.889	2.623	2.400	2.711	3.188
3.20	2.513	1.580	2.585	1.945	2.665	2.472	2.756	3.283
3.25	2.550	1.625	2.624	2.002	2.707	2.543	2.801	3.378
3.30	2.588	1.671	2.664	2.058	2.749	2.615	2.845	3.473
3.35	2.625	1.717	2.704	2.114	2.791	2.686	2.890	3.568
3.40	2.663	1.763	2.743	2.171	2.833	2.758	2.935	3.663
3.45	2.701	1.808	2.783	2.227	2.875	2.830	2.979	3.758
3.50	2.738	1.854	2.823	2.283	2.917	2.901	3.024	3.853
3.55	2.776	1.900	2.862	2.340	2.959	2.973	3.068	3.948
3.60	2.813	1.946	2.902	2.396	3.001	3.044	3.113	4.043
3.65	2.851	1.991	2.942	2.452	3.043	3.116	3.158	4.138



## WORKING STRESS METHOD

TABLE 75 FLEXURE—REINFORCEMENT PERCENTAGES FOR DOUBLY REINFORCED SECTIONS

$\sigma_{cbc} = 10.0 \text{ N/mm}^2$   
 $\sigma_{st} = 140 \text{ N/mm}^2$

$M/bd^2$ , $\text{N/mm}^2$	$d'/d=0.05$		$d'/d=0.10$		$d'/d=0.15$		$d'/d=0.20$	
	$P_t$	$P_c$	$P_t$	$P_c$	$P_t$	$P_c$	$P_t$	$P_c$
1.74	1.434	0.006	1.434	0.008	1.434	0.010	1.435	0.013
1.75	1.441	0.015	1.442	0.019	1.443	0.024	1.443	0.032
1.80	1.479	0.062	1.481	0.076	1.485	0.097	1.488	0.128
1.85	1.516	0.108	1.521	0.133	1.527	0.169	1.533	0.224
1.90	1.554	0.154	1.561	0.190	1.569	0.241	1.577	0.321
1.95	1.591	0.201	1.601	0.247	1.611	0.314	1.622	0.417
2.00	1.629	0.247	1.640	0.304	1.653	0.386	1.667	0.513
2.05	1.667	0.293	1.680	0.361	1.695	0.459	1.711	0.609
2.10	1.704	0.339	1.720	0.418	1.737	0.531	1.756	0.705
2.15	1.742	0.386	1.759	0.475	1.779	0.603	1.801	0.801
2.20	1.779	0.432	1.799	0.532	1.821	0.676	1.845	0.897
2.25	1.817	0.478	1.839	0.589	1.863	0.748	1.890	0.994
2.30	1.855	0.524	1.878	0.646	1.905	0.821	1.935	1.090
2.35	1.892	0.571	1.918	0.703	1.947	0.893	1.979	1.186
2.40	1.930	0.617	1.958	0.760	1.989	0.965	2.024	1.282
2.45	1.967	0.663	1.997	0.817	2.031	1.038	2.068	1.378
2.50	2.005	0.709	2.037	0.874	2.073	1.110	2.113	1.474
2.55	2.043	0.756	2.077	0.931	2.115	1.183	2.158	1.571
2.60	2.080	0.802	2.116	0.988	2.157	1.255	2.202	1.667
2.65	2.118	0.848	2.156	1.045	2.199	1.327	2.247	1.763
2.70	2.155	0.895	2.196	1.102	2.241	1.400	2.292	1.859
2.75	2.193	0.941	2.235	1.159	2.283	1.472	2.336	1.955
2.80	2.231	0.987	2.275	1.216	2.325	1.545	2.381	2.051
2.85	2.268	1.033	2.315	1.273	2.367	1.617	2.426	2.147
2.90	2.306	1.080	2.354	1.330	2.409	1.689	2.470	2.244
2.95	2.343	1.126	2.394	1.387	2.451	1.762	2.515	2.340
3.00	2.381	1.172	2.434	1.444	2.493	1.834	2.560	2.436
3.05	2.419	1.218	2.474	1.500	2.535	1.906	2.604	2.532
3.10	2.456	1.265	2.513	1.557	2.577	1.979	2.649	2.628
3.15	2.494	1.311	2.553	1.614	2.619	2.051	2.693	2.724
3.20	2.531	1.357	2.593	1.671	2.661	2.124	2.738	2.821
3.25	2.569	1.404	2.632	1.728	2.703	2.196	2.783	2.917
3.30	2.607	1.450	2.672	1.785	2.745	2.268	2.827	3.013
3.35	2.644	1.496	2.712	1.842	2.787	2.341	2.872	3.109
3.40	2.682	1.542	2.751	1.899	2.829	2.413	2.917	3.205
3.45	2.719	1.589	2.791	1.956	2.871	2.486	2.961	3.301
3.50	2.757	1.635	2.831	2.013	2.913	2.558	3.006	3.397
3.55	2.794	1.681	2.870	2.070	2.955	2.630	3.051	3.494
3.60	2.832	1.727	2.910	2.127	2.997	2.703	3.095	3.590
3.65	2.870	1.774	2.950	2.184	3.039	2.775	3.140	3.686
3.70	2.907	1.820	2.989	2.241	3.081	2.848	3.185	3.782
3.75	2.945	1.866	3.029	2.298	3.123	2.920	3.229	3.878
3.80	2.982	1.912	3.069	2.355	3.165	2.992	3.274	3.974
3.85	3.020	1.959	3.108	2.412	3.207	3.065		
3.90	3.058	2.005	3.148	2.469	3.249	3.137		

WORKING STRESS METHOD

TABLE 76 FLEXURE — REINFORCEMENT PERCENTAGES FOR DOUBLY REINFORCED SECTIONS

$\sigma_{cbc} = 5.0 \text{ N/mm}^2$   
 $\sigma_{st} = 230 \text{ N/mm}^2$

$M/bd^2$ , N/mm	$d'/d = 0.05$		$d'/d = 0.10$		$d'/d =$		$d'/d = 0.20$	
	$P_t$	$P_c$	$P_t$	$P_c$	$P_t$	$P_c$	$P_t$	$P_c$
0.66	0.317	0.007	0.318	0.010	0.318	0.014	0.318	0.023
0.70	0.336	0.045	0.337	0.060	0.338	0.087	0.340	0.144
0.75	0.359	0.092	0.361	0.123	0.364	0.177	0.367	0.295
0.80	0.381	0.139	0.385	0.186	0.389	0.268	0.394	0.446
0.85	0.404	0.187	0.409	0.249	0.415	0.359	0.421	0.596
0.90	0.427	0.234	0.433	0.312	0.441	0.450	0.448	0.747
0.95	0.450	0.281	0.458	0.375	0.466	0.540	0.476	0.898
1.00	0.473	0.328	0.482	0.438	0.492	0.631	0.503	1.048
1.05	0.496	0.375	0.506	0.501	0.517	0.722	0.530	1.199
1.10	0.519	0.422	0.530	0.564	0.543	0.812	0.557	1.350
1.15	0.542	0.469	0.554	0.627	0.568	0.903	0.584	1.501
1.20	0.564	0.517	0.578	0.690	0.594	0.994	0.611	1.651
1.25	0.587	0.564	0.603	0.753	0.620	1.085	0.639	1.802
1.30	0.610	0.611	0.627	0.816	0.645	1.175	0.666	1.953
1.35	0.633	0.658	0.651	0.879	0.671	1.266	0.693	2.104
1.40	0.656	0.705	0.675	0.942	0.696	1.357	0.720	2.254
1.45	0.679	0.752	0.699	1.005	0.722	1.447	0.747	2.405
1.50	0.702	0.800	0.723	1.068	0.747	1.538	0.775	2.556
1.55	0.725	0.847	0.747	1.131	0.773	1.629	0.802	2.707
1.60	0.748	0.894	0.772	1.194	0.799	1.719	0.829	2.857
1.65	0.770	0.941	0.796	1.257	0.824	1.810	0.856	3.008
1.70	0.793	0.988	0.820	1.319	0.850	1.901	0.883	3.159
1.75	0.816	1.035	0.844	1.382	0.875	1.992	0.910	3.309
1.80	0.839	1.082	0.868	1.445	0.901	2.082	0.938	3.460
1.85	0.862	1.130	0.892	1.508	0.926	2.173	0.965	3.611
1.90	0.885	1.177	0.917	1.571	0.952	2.264	0.992	3.762
1.95	0.908	1.224	0.941	1.634	0.978	2.354	1.019	3.912
2.00	0.931	1.271	0.965	1.697	1.003	2.445		
2.05	0.953	1.318	0.989	1.760	1.029	2.536		
2.10	0.976	1.365	1.013	1.823	1.054	2.627		
2.15	0.999	1.413	1.037	1.886	1.080	2.717		
2.20	1.022	1.460	1.061	1.949	1.105	2.808		
2.25	1.045	1.507	1.086	2.012	1.131	2.899		
2.30	1.068	1.554	1.110	2.075	1.157	2.989		
2.35	1.091	1.601	1.134	2.138	1.182	3.080		
2.40	1.114	1.648	1.158	2.201	1.208	3.171		
2.45	1.137	1.695	1.182	2.264	1.233	3.262		
2.50	1.159	1.743	1.206	2.327	1.259	3.352		
2.55	1.182	1.790	1.231	2.390	1.284	3.443		
2.60	1.205	1.837	1.255	2.453	1.310	3.534		
2.65	1.228	1.884	1.279	2.516	1.336	3.624		
2.70	1.251	1.931	1.303	2.579	1.361	3.715		
2.75	1.274	1.978	1.327	2.642	1.387	3.806		
2.80	1.297	2.026	1.351	2.705	1.412	3.897		
2.85	1.320	2.073	1.375	2.768	1.438	3.987		



WORKING STRESS METHOD

TABLE 77 FLEXURE—REINFORCEMENT PERCENTAGES FOR DOUBLY REINFORCED SECTIONS

$\sigma_{cbc} = 7.0 \text{ N/mm}^2$   
 $\sigma_{st} = 230 \text{ N/mm}^2$

$M/bd^2$ $\text{N/mm}^2$	$d'/d = 0.05$		$d'/d = 0.10$		$d'/d = 0.15$		$d'/d = 0.20$	
	$P_t$	$P_c$	$P_t$	$P_c$	$P_t$	$P_c$	$P_t$	$P_c$
0.92	0.442	0.007	0.443	0.009	0.443	0.013	0.443	0.021
0.95	0.456	0.035	0.457	0.047	0.458	0.068	0.459	0.113
1.00	0.479	0.083	0.481	0.111	0.484	0.160	0.486	0.266
1.05	0.502	0.131	0.505	0.175	0.509	0.252	0.514	0.419
1.10	0.525	0.179	0.530	0.239	0.535	0.344	0.541	0.572
1.15	0.548	0.227	0.554	0.303	0.560	0.436	0.568	0.725
1.20	0.571	0.275	0.578	0.367	0.586	0.528	0.595	0.878
1.25	0.593	0.323	0.602	0.431	0.612	0.620	0.622	1.031
1.30	0.616	0.370	0.626	0.495	0.637	0.712	0.650	1.184
1.35	0.639	0.418	0.650	0.558	0.663	0.805	0.677	1.337
1.40	0.662	0.466	0.674	0.622	0.688	0.897	0.704	1.490
1.45	0.685	0.514	0.699	0.686	0.714	0.989	0.731	1.643
1.50	0.708	0.562	0.723	0.750	0.739	1.081	0.758	1.796
1.55	0.731	0.610	0.747	0.814	0.765	1.173	0.785	1.949
1.60	0.754	0.658	0.771	0.878	0.791	1.265	0.813	2.102
1.65	0.777	0.705	0.795	0.942	0.816	1.357	0.840	2.255
1.70	0.799	0.753	0.819	1.006	0.842	1.449	0.867	2.408
1.75	0.822	0.801	0.844	1.070	0.867	1.541	0.894	2.561
1.80	0.845	0.849	0.868	1.134	0.893	1.633	0.921	2.714
1.85	0.868	0.897	0.892	1.198	0.919	1.725	0.948	2.867
1.90	0.891	0.945	0.916	1.262	0.944	1.817	0.976	3.020
1.95	0.914	0.993	0.940	1.325	0.970	1.909	1.003	3.173
2.00	0.937	1.040	0.964	1.389	0.995	2.002	1.030	3.326
2.05	0.960	1.088	0.988	1.453	1.021	2.094	1.057	3.479
2.10	0.982	1.136	1.013	1.517	1.046	2.186	1.084	3.632
2.15	1.005	1.184	1.037	1.581	1.072	2.278	1.111	3.785
2.20	1.028	1.232	1.061	1.645	1.098	2.370	1.139	3.938
2.25	1.051	1.280	1.085	1.709	1.123	2.462		
2.30	1.074	1.328	1.109	1.773	1.149	2.554		
2.35	1.097	1.376	1.133	1.837	1.174	2.646		
2.40	1.120	1.423	1.158	1.901	1.200	2.738		
2.45	1.143	1.471	1.182	1.965	1.225	2.830		
2.50	1.166	1.519	1.206	2.028	1.251	2.922		
2.55	1.188	1.567	1.230	2.092	1.277	3.014		
2.60	1.211	1.615	1.254	2.156	1.302	3.106		
2.65	1.234	1.663	1.278	2.220	1.328	3.198		
2.70	1.257	1.711	1.303	2.284	1.353	3.291		
2.75	1.280	1.758	1.327	2.348	1.379	3.383		
2.80	1.303	1.806	1.351	2.412	1.404	3.475		
2.85	1.326	1.854	1.375	2.476	1.430	3.567		
2.90	1.349	1.902	1.399	2.540	1.456	3.659		
2.95	1.371	1.950	1.423	2.604	1.481	3.751		
3.00	1.394	1.998	1.447	2.668	1.507	3.843		
3.05	1.417	2.046	1.472	2.732	1.532	3.935		
3.10	1.440	2.093	1.496	2.795	1.558	4.027		

WORKING STRESS METHOD

TABLE 78 FLEXURE — REINFORCEMENT PERCENTAGES FOR DOUBLY REINFORCED SECTIONS

$\sigma_{cbc} = 8.5 \text{ N/mm}^2$   
 $\sigma_{st} = 230 \text{ N/mm}^2$

$M/bd^2$ , $\text{N/mm}^2$	$d'/d = 0.05$		$d'/d = 0.10$		$d'/d = 0.15$		$d'/d = 0.20$	
	$P_t$	$P_c$	$P_t$	$P_c$	$P_t$	$P_c$	$P_t$	$P_c$
1.11	0.334	0.001	0.534	0.002	0.534	0.002	0.534	0.004
1.15	0.352	0.040	0.553	0.053	0.554	0.077	0.556	0.128
1.20	0.375	0.088	0.577	0.118	0.580	0.170	0.583	0.282
1.25	0.398	0.137	0.602	0.183	0.606	0.263	0.610	0.437
1.30	0.621	0.185	0.626	0.247	0.631	0.356	0.637	0.592
1.35	0.644	0.234	0.650	0.312	0.657	0.449	0.665	0.747
1.40	0.667	0.282	0.674	0.377	0.682	0.542	0.692	0.901
1.45	0.690	0.330	0.698	0.441	0.708	0.636	0.719	1.056
1.50	0.712	0.379	0.722	0.506	0.734	0.729	0.746	1.211
1.55	0.735	0.427	0.747	0.570	0.759	0.822	0.773	1.366
1.60	0.758	0.476	0.771	0.635	0.785	0.915	0.800	1.520
1.65	0.781	0.524	0.795	0.700	0.810	1.008	0.828	1.675
1.70	0.804	0.572	0.819	0.764	0.836	1.101	0.855	1.830
1.75	0.827	0.621	0.843	0.829	0.861	1.194	0.882	1.985
1.80	0.850	0.669	0.867	0.894	0.887	1.287	0.909	2.139
1.85	0.873	0.718	0.891	0.958	0.913	1.381	0.936	2.294
1.90	0.896	0.766	0.916	1.023	0.938	1.474	0.963	2.449
1.95	0.918	0.814	0.940	1.088	0.964	1.567	0.991	2.604
2.00	0.941	0.863	0.964	1.152	0.989	1.660	1.018	2.758
2.05	0.964	0.911	0.988	1.217	1.015	1.753	1.045	2.913
2.10	0.987	0.960	1.012	1.282	1.040	1.846	1.072	3.068
2.15	1.010	1.008	1.036	1.346	1.066	1.939	1.099	3.223
2.20	1.033	1.057	1.061	1.411	1.092	2.032	1.126	3.377
2.25	1.056	1.105	1.085	1.475	1.117	2.126	1.154	3.532
2.30	1.079	1.153	1.109	1.540	1.143	2.219	1.181	3.687
2.35	1.101	1.202	1.133	1.605	1.168	2.312	1.208	3.842
2.40	1.124	1.250	1.157	1.669	1.194	2.405	1.235	3.996
2.45	1.147	1.299	1.181	1.734	1.219	2.498		
2.50	1.170	1.347	1.205	1.799	1.245	2.591		
2.55	1.193	1.395	1.230	1.863	1.271	2.684		
2.60	1.216	1.444	1.254	1.928	1.296	2.777		
2.65	1.239	1.492	1.278	1.993	1.322	2.871		
2.70	1.262	1.541	1.302	2.057	1.347	2.964		
2.75	1.285	1.589	1.326	2.122	1.373	3.057		
2.80	1.307	1.637	1.350	2.186	1.398	3.150		
2.85	1.330	1.686	1.375	2.251	1.424	3.243		
2.90	1.353	1.734	1.399	2.316	1.450	3.336		
2.95	1.376	1.783	1.423	2.380	1.475	3.429		
3.00	1.399	1.831	1.447	2.445	1.501	3.522		
3.05	1.422	1.879	1.471	2.510	1.526	3.616		
3.10	1.445	1.928	1.495	2.574	1.552	3.709		
3.15	1.468	1.976	1.520	2.639	1.578	3.802		
3.20	1.490	2.025	1.544	2.704	1.603	3.895		
3.25	1.513	2.073	1.568	2.768	1.629	3.988		
3.30	1.536	2.122	1.592	2.833	1.654	4.081		

$\sigma_{st}$   
230  
 $\sigma_{cbc}$   
10.0

**WORKING STRESS METHOD**

**TABLE 79 FLEXURE — REINFORCEMENT PERCENTAGES FOR DOUBLY REINFORCED SECTIONS**

$\sigma_{cbc} = 10.0 \text{ N/mm}^2$   
 $\sigma_{st} = 230 \text{ N/mm}^2$

$M/bd^2$ , $\text{N/mm}^2$	$d'/d=0.05$		$d'/d=0.10$		$d'/d=0.15$		$d'/d=0.20$	
	$P_t$	$P_c$	$P_t$	$P_c$	$P_t$	$P_c$	$P_t$	$P_c$
1.31	0.630	0.005	0.630	0.007	0.630	0.011	0.631	0.017
1.35	0.648	0.045	0.650	0.060	0.651	0.086	0.652	0.143
1.40	0.671	0.094	0.674	0.125	0.676	0.180	0.679	0.299
1.45	0.694	0.143	0.698	0.190	0.702	0.274	0.707	0.456
1.50	0.717	0.192	0.722	0.256	0.728	0.368	0.734	0.612
1.55	0.740	0.241	0.746	0.321	0.753	0.463	0.761	0.769
1.60	0.763	0.289	0.770	0.387	0.779	0.557	0.788	0.925
1.65	0.786	0.338	0.794	0.452	0.804	0.651	0.815	1.082
1.70	0.809	0.387	0.819	0.517	0.830	0.745	0.843	1.238
1.75	0.831	0.436	0.843	0.583	0.855	0.839	0.870	1.395
1.80	0.854	0.485	0.867	0.648	0.881	0.934	0.897	1.551
1.85	0.877	0.534	0.891	0.713	0.907	1.028	0.924	1.708
1.90	0.900	0.583	0.915	0.779	0.932	1.122	0.951	1.865
1.95	0.923	0.632	0.939	0.844	0.958	1.216	0.978	2.021
2.00	0.946	0.681	0.964	0.910	0.983	1.310	1.006	2.178
2.05	0.969	0.730	0.988	0.975	1.009	1.405	1.033	2.334
2.10	0.992	0.779	1.012	1.040	1.034	1.499	1.060	2.491
2.15	1.015	0.828	1.036	1.106	1.060	1.593	1.087	2.647
2.20	1.037	0.877	1.060	1.171	1.086	1.687	1.114	2.804
2.25	1.060	0.926	1.084	1.237	1.111	1.781	1.141	2.960
2.30	1.083	0.975	1.108	1.302	1.137	1.876	1.169	3.117
2.35	1.106	1.024	1.133	1.367	1.162	1.970	1.196	3.273
2.40	1.129	1.073	1.157	1.433	1.188	2.064	1.223	3.430
2.45	1.152	1.122	1.181	1.498	1.213	2.158	1.250	3.586
2.50	1.175	1.171	1.205	1.564	1.239	2.252	1.277	3.743
2.55	1.198	1.220	1.229	1.629	1.265	2.347	1.304	3.899
2.60	1.220	1.269	1.253	1.694	1.290	2.441		
2.65	1.243	1.318	1.278	1.760	1.316	2.535		
2.70	1.266	1.367	1.302	1.825	1.341	2.629		
2.75	1.289	1.416	1.326	1.890	1.367	2.723		
2.80	1.312	1.465	1.350	1.956	1.393	2.818		
2.85	1.335	1.514	1.374	2.021	1.418	2.912		
2.90	1.358	1.563	1.398	2.087	1.444	3.006		
2.95	1.381	1.612	1.422	2.152	1.469	3.100		
3.00	1.404	1.661	1.447	2.217	1.495	3.194		
3.05	1.426	1.710	1.471	2.283	1.520	3.289		
3.10	1.449	1.759	1.495	2.348	1.546	3.383		
3.15	1.472	1.807	1.519	2.414	1.572	3.477		
3.20	1.495	1.856	1.543	2.479	1.597	3.571		
3.25	1.518	1.905	1.567	2.544	1.623	3.665		
3.30	1.541	1.954	1.592	2.610	1.648	3.760		
3.35	1.564	2.003	1.616	2.675	1.674	3.854		
3.40	1.587	2.052	1.640	2.740	1.699	3.948		
3.45	1.609	2.101	1.664	2.806				
3.50	1.632	2.150	1.688	2.871				

**TABLE 80 SHEAR — PERMISSIBLE SHEAR STRESS IN CONCRETE,  $\tau_c$ , N/mm<sup>2</sup>**

100 $\frac{A_{st}}{bd}$	GRADE OF CONCRETE					
	M15	M20	M25	M30	M35	M40
0.20	0.20	0.20	0.21	0.21	0.21	0.21
0.30	0.24	0.24	0.25	0.25	0.25	0.25
0.40	0.27	0.27	0.28	0.28	0.29	0.29
0.50	0.29	0.30	0.31	0.31	0.31	0.32
0.60	0.31	0.32	0.33	0.33	0.34	0.34
0.70	0.33	0.34	0.35	0.36	0.36	0.37
0.80	0.34	0.36	0.37	0.38	0.38	0.39
0.90	0.36	0.37	0.39	0.39	0.40	0.41
1.00	0.37	0.39	0.40	0.41	0.42	0.42
1.10	0.38	0.40	0.42	0.43	0.43	0.44
1.20	0.40	0.41	0.43	0.44	0.45	0.45
1.30	0.41	0.43	0.44	0.45	0.46	0.47
1.40	0.42	0.44	0.45	0.46	0.47	0.48
1.50	0.42	0.45	0.46	0.48	0.49	0.49
1.60	0.43	0.46	0.47	0.49	0.50	0.51
1.70	0.44	0.47	0.48	0.50	0.51	0.52
1.80	0.44	0.47	0.49	0.51	0.52	0.53
1.90	0.44	0.48	0.50	0.52	0.53	0.54
2.00	0.44	0.49	0.51	0.53	0.54	0.55
2.10	0.44	0.50	0.52	0.54	0.55	0.56
2.20	0.44	0.51	0.53	0.54	0.56	0.57
2.30	0.44	0.51	0.53	0.55	0.57	0.58
2.40	0.44	0.51	0.54	0.56	0.57	0.59
2.50	0.44	0.51	0.55	0.57	0.58	0.60
2.60	0.44	0.51	0.56	0.57	0.59	0.60
2.70	0.44	0.51	0.56	0.58	0.60	0.61
2.80	0.44	0.51	0.57	0.59	0.60	0.62
2.90	0.44	0.51	0.57	0.59	0.61	0.63

**TABLE 81 SHEAR — VERTICAL STIRRUPS**

Values of  $\frac{V}{d}$  for two legged stirrups, kN/cm

STIRRUP SPACING, cm	$\sigma_{sv} = 140 \text{ N/mm}^2$				$\sigma_{sv} = 230 \text{ N/mm}^2$			
	DIAMETER, mm				DIAMETER, mm			
	6	8	10	12	6	8	10	12
5	1.583	2.815	4.398	6.333	2.601	4.624	7.226	10.405
6	1.314	2.346	3.665	5.278	2.168	3.854	6.021	8.671
7	1.131	2.011	3.142	4.524	1.858	3.303	5.161	7.432
8	0.990	1.759	2.749	3.958	1.626	2.890	4.516	6.503
9	0.880	1.564	2.443	3.519	1.445	2.569	4.014	5.781
10	0.792	1.407	2.199	3.167	1.301	2.312	3.613	5.202
11	0.720	1.279	1.999	2.879	1.182	2.102	3.284	4.730
12	0.660	1.173	1.833	2.639	1.084	1.927	3.012	4.335
13	0.609	1.083	1.692	2.436	1.000	1.779	2.779	4.002
14	0.565	1.005	1.571	2.262	0.920	1.652	2.580	3.716
15	0.528	0.938	1.466	2.111	0.867	1.541	2.409	3.468
16	0.495	0.880	1.374	1.979	0.813	1.445	2.258	3.252
17	0.466	0.828	1.294	1.863	0.765	1.360	2.125	3.060
18	0.440	0.782	1.222	1.759	0.723	1.285	2.007	2.890
19	0.417	0.741	1.157	1.667	0.605	1.217	1.901	2.738
20	0.396	0.704	1.100	1.583	0.650	1.156	1.806	2.601
25	0.317	0.563	0.880	1.267	0.520	0.925	1.445	2.081
30	0.264	0.469	0.733	1.056	0.432	0.771	1.204	1.734
35	0.226	0.402	0.628	0.905	0.372	0.661	1.032	1.486
40	0.198	0.352	0.550	0.792	0.325	0.578	0.903	1.301
45	0.176	0.313	0.489	0.704	0.289	0.514	0.803	1.156

**TABLE 82 SHEAR — BENT UP BARS**

Values of  $V_s$  for single bar, kN

BAR DIAMETER, mm	$\sigma_{sv} = 140 \text{ N/mm}^2$ up to 20 mm diameter $= 130 \text{ N/mm}^2$ over 20 mm diameter		$\sigma_{sv} = 230 \text{ N/mm}^2$	
	$\alpha = 45^\circ$	$\alpha = 60^\circ$	$\alpha = 45^\circ$	$\alpha = 60^\circ$
	10	7.78	9.52	12.77
12	11.20	13.71	18.39	22.53
16	19.90	24.38	32.70	40.05
18	25.19	30.86	41.39	50.69
20	31.10	38.09	51.09	62.58
22	34.94	42.80	61.82	75.72
25	45.12	55.26	79.83	97.77
28	56.60	69.32	100.14	122.65
32	73.93	90.54	130.80	160.19
36	93.57	114.60	165.54	202.75

NOTE —  $\alpha$  is the angle between the bent up bar and the axis of the member.

**TABLE 83 DEVELOPMENT LENGTH FOR PLAIN BARS**

$\sigma_{st} = 140 \text{ N/mm}^2$  for bars up to 20 mm diameter  
 $= 130 \text{ N/mm}^2$  for bars over 20 mm diameter  
 $\sigma_{sc} = 130 \text{ N/mm}^2$  for all diameter

Tabulated values are in centimetres.

BAR DIAMETER, mm	TENSION BARS				COMPRESSION BARS			
	GRADE OF CONCRETE				GRADE OF CONCRETE			
	M15	M20	M25	M30	M15	M20	M25	M30
6	35.0	26.3	23.3	21.0	26.0	19.5	17.3	15.6
8	46.7	35.0	31.1	28.0	34.7	26.0	23.1	20.8
10	58.3	43.8	38.9	35.0	43.3	32.5	28.9	26.0
12	70.0	52.5	46.7	42.0	52.0	39.0	34.7	31.2
16	93.3	70.0	62.2	56.0	69.3	52.0	46.2	41.6
18	105.0	78.8	70.0	63.0	78.0	58.5	52.0	46.8
20	116.7	87.5	77.8	70.0	86.7	65.0	57.8	52.0
22	119.2	89.4	79.4	71.5	95.3	71.5	63.6	57.2
25	135.4	101.6	90.3	81.3	108.3	81.3	72.2	65.0
28	151.7	113.8	101.1	91.0	121.3	91.0	80.9	72.8
32	173.3	130.0	115.6	104.0	138.7	104.0	92.4	83.2
36	195.0	146.3	130.0	117.0	156.0	117.0	104.0	93.6

**TABLE 84 DEVELOPMENT LENGTH FOR DEFORMED BARS**

Tabulated values are in centimetres.

$\sigma_{st} = 230 \text{ N/mm}^2$   
 $\sigma_{sc} = 190 \text{ N/mm}^2$

BAR DIAMETER, mm	TENSION BARS				COMPRESSION BARS			
	GRADE OF CONCRETE				GRADE OF CONCRETE			
	M15	M20	M25	M30	M15	M20	M25	M30
6	41.1	30.8	27.4	24.6	27.1	20.4	18.1	16.3
8	54.8	41.1	36.5	32.9	36.2	27.1	24.1	21.7
10	68.5	51.3	45.6	41.1	45.2	33.9	30.2	27.1
12	82.1	61.6	54.8	49.3	54.3	40.7	36.2	32.6
16	109.5	82.1	73.0	65.7	72.4	54.3	48.3	43.4
18	123.2	92.4	82.1	73.9	81.4	61.1	54.3	48.9
20	136.9	102.7	91.3	82.1	90.5	67.9	60.3	54.3
22	150.6	112.9	100.4	90.4	99.5	74.6	66.3	59.7
25	171.1	128.3	114.1	102.7	113.1	84.8	75.4	67.9
28	191.7	143.8	127.8	115.0	126.7	95.0	84.4	76.0
32	219.0	164.3	146.0	131.4	144.8	108.6	96.5	86.9
36	246.4	184.8	164.3	147.9	162.9	122.1	108.6	97.7

**TABLE 85 DEVELOPMENT LENGTH FOR DEFORMED BARS**

Tabulated values are in centimetres.

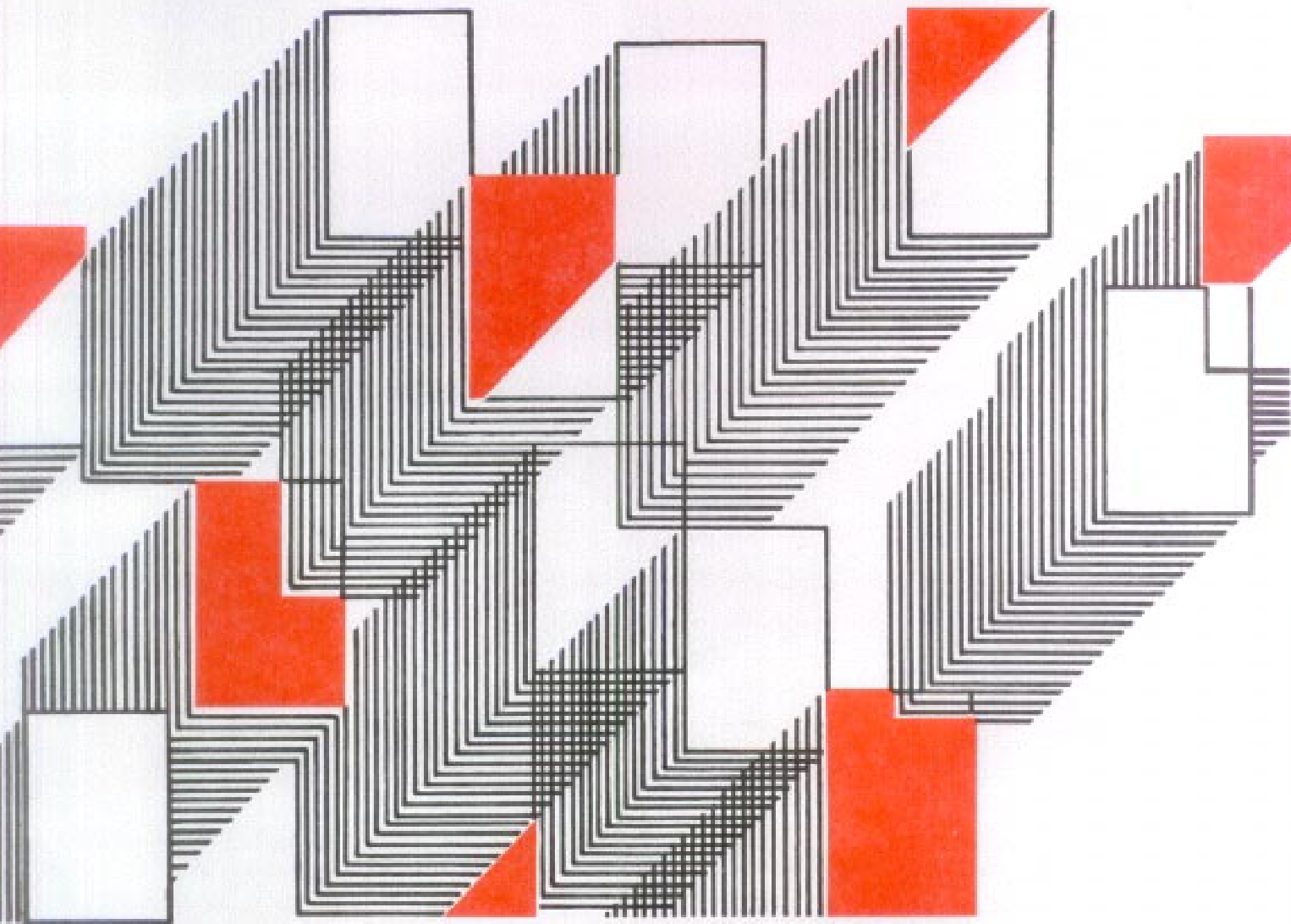
$\sigma_{st} = 275 \text{ N/mm}^2$   
 $\sigma_{sc} = 190 \text{ N/mm}^2$

BAR DIAMETER, mm	TENSION BARS				COMPRESSION BARS			
	GRADE OF CONCRETE				GRADE OF CONCRETE			
	M15	M20	M25	M30	M15	M20	M25	M30
6	49.1	36.8	32.7	29.5	27.1	20.4	18.1	16.3
8	65.5	49.1	43.7	39.3	36.2	27.1	24.1	21.7
10	81.8	61.4	54.6	49.1	45.2	33.9	30.2	27.1
12	98.2	73.7	65.5	58.9	54.3	40.7	36.2	32.6
16	131.0	98.2	87.3	78.6	72.4	54.3	48.3	43.4
18	147.3	110.5	98.2	88.4	81.4	61.1	54.3	48.9
20	163.7	122.8	109.1	98.2	90.5	67.9	60.3	54.3
22	180.1	135.0	120.0	108.0	99.5	74.6	66.3	59.7
25	204.6	153.5	136.4	122.8	113.1	84.8	75.4	67.9
28	229.2	171.9	152.8	137.5	126.7	95.0	84.4	76.0
32	261.9	196.4	174.6	157.1	144.8	108.6	96.5	86.9
36	294.6	221.0	196.4	176.8	162.9	122.1	108.6	97.7



As in the Original Standard, this Page is Intentionally Left Blank

# DEFLECTION CALCULATION



As in the Original Standard, this Page is Intentionally Left Blank

## 7. DEFLECTION CALCULATION

### 7.1 EFFECTIVE MOMENT OF INERTIA

A method of calculating the deflections is given in Appendix E of the Code. This method requires the use of an effective moment of inertia  $I_{eff}$  given by the following equation

$$I_{eff} = \frac{I_r}{1.2 - \frac{M_r}{M} \frac{z}{d} \left(1 - \frac{x}{d}\right) \frac{b_w}{b}}$$

but,  $I_r \leq I_{eff} \leq I_{gr}$

where

$I_r$  is the moment of inertia of the cracked section;

$M_r$  is the cracking moment, equal to  $\frac{f_{cr} I_{gr}}{y_t}$

where

$f_{cr}$  is the modulus of rupture of concrete,  $I_{gr}$  is the moment of inertia of the gross section neglecting the reinforcement and  $y_t$  is the distance from the centroidal axis of the gross section to the extreme fibre in tension;

$M$  is the maximum moment under service loads;

$z$  is the lever arm;

$d$  is the effective depth;

$x$  is the depth of neutral axis;

$b_w$  is the breadth of the web; and

$b$  is the breadth of the compression face.

The values of  $x$  and  $z$  are those obtained by elastic theory. Hence  $z = d - x/3$  for rectangular sections; also  $b = b_w$  for rectangular sections. For flanged sections where the flange is in compression,  $b$  will be equal to the flange width  $b_f$ . The value of  $z$  for flanged beams will depend on the flange dimensions, but in order to simplify the calculations it is conservatively assumed the value of  $z$  for flanged beam is also  $d - x/3$ . With this assumption, the expression effective moment of inertia may be written as follows:

$$\frac{I_{eff}}{I_r} = \frac{1}{1.2 - \frac{M_r}{M} \left(1 - \frac{x}{3d}\right) \left(1 - \frac{x}{d}\right) \frac{b_w}{b_f}}$$

but,  $\frac{I_{eff}}{I_r} \geq 1$

and  $I_{eff} \leq I_{gr}$

Chart 89 can be used for finding the value of

$\frac{I_{eff}}{I_r}$  in accordance with the above equation.

The chart takes into account the condition  $\frac{I_{eff}}{I_r} > 1$ . After finding the value of  $I_{eff}$  it has

to be compared with  $I_{gr}$  and the lower of the two values should be used for calculating the deflection.

For continuous beams, a weighted average value of  $I_{eff}$  should be used, as given in B-2.1 of the Code.

### 7.2 SHRINKAGE AND CREEP DEFLECTIONS

Deflections due to shrinkage and creep can be calculated in accordance with clauses B-3 and B-4 of the Code. This is illustrated in Example 12.

#### Example 12 Check for deflection

Calculate the deflection of a cantilever beam of the section designed in Example 3, with further data as given below:

Span of cantilever	4.0 m
Bending moment at service loads	210 kN.m

Sixty percent of the above moment is due to permanent loads, the loading being distributed uniformly on the span.

$$I_{gr} = \frac{bD^3}{12} = \frac{300 \times (600)^3}{12} = 5.4 \times 10^9 \text{ mm}^4$$

From clause 5.2.2 of the Code,

Flexural tensile strength,

$$f_{cr} = 0.7 \sqrt{f_{ck}} \text{ N/mm}^2$$

$$f_{cr} = 0.7 \sqrt{15} = 2.71 \text{ N/mm}^2$$

$$y_t = D/2 = \frac{600}{2} = 300 \text{ mm}$$

$$M_r = \frac{f_{cr} I_{gr}}{y_t} = \frac{2.71 \times 5.4 \times 10^9}{300} = 4.88 \times 10^7 \text{ N.mm}$$

$$d'/d = \left(\frac{3.75}{56.25}\right) = 0.067$$

$d'/d = 0.05$  will be used in referring to Tables.

From 5.2.3.1 of the Code,

$$E_c = 5700 \sqrt{f_{ck}} \text{ N/mm}^2$$

$$= 5700 \sqrt{15} = 22.1 \times 10^3 \text{ N/mm}^2$$

$$E_s = 200 \text{ kN/mm}^2 = 2 \times 10^5 \text{ N/mm}^2$$

$$m = E_s/E_c = \frac{2 \times 10^5}{22.1 \times 10^3} = 9.05$$

From Example 3,

$$p_t = 1.117, p_c = 0.418$$

$$p_c(m-1)/(p_t m) = (0.418 \times 8.05) / (1.117 \times 9.05) = 0.333$$

$$p_t m = 1.117 \times 9.05 = 10.11$$

Referring to Table 87,

$$I_r / (bd^3 / 12) = 0.720$$

$$\therefore I_r = 0.720 \times 300 \times (562.5)^3 / 12$$

$$= 3.204 \times 10^9 \text{ mm}^4$$

Referring to Table 91,

$$\frac{x}{d} = 0.338$$

Moment at service load,  $M = 210 \text{ kN.m}$   
 $= 21.0 \times 10^7 \text{ N.mm}$

$$M_r / M = \frac{4.88 \times 10^7}{21.0 \times 10^7} = 0.232$$

Referring to Chart 89.

$$I_{\text{eff}} / I_r = 1.0$$

$$\therefore I_{\text{eff}} = I_r = 3.204 \times 10^9 \text{ mm}^4$$

For a cantilever with uniformly distributed load,

$$\text{Elastic deflection} = \frac{1}{4} \frac{Ml^2}{EI_{\text{eff}}}$$

$$= \frac{21.0 \times 10^7 \times (4000)^2}{4 \times 22.1 \times 10^3 \times 3.204 \times 10^9}$$

$$= 11.86 \text{ mm} \quad \dots(1)$$

Deflection due to shrinkage (see clause B-3 of the Code):

$$a_{cs} = k_3 \Psi_{cs} l^2$$

$$k_3 = 0.5 \text{ for cantilevers}$$

$$p_t = 1.117, p_c = 0.418$$

$$p_t - p_c = 1.117 - 0.418 = 0.699 < 1.0$$

$$\therefore k_4 = 0.72 \times \frac{p_t - p_c}{\sqrt{p_t}}$$

$$= 0.72 \times \frac{(1.117 - 0.418)}{\sqrt{1.117}}$$

$$= 0.476$$

In the absence of data, the value of the ultimate shrinkage strain  $\xi_{cs}$  is taken as 0.0003 as given in 5.2.4.1 of the Code.

$$D = 600 \text{ mm}$$

$$\therefore \text{Shrinkage curvature } \Psi_{cs} = k_4 \frac{\xi_{cs}}{D}$$

$$= \frac{0.476 \times 0.0003}{600} = 2.38 \times 10^{-7}$$

$$a_{cs} = 0.5 \times 2.38 \times 10^{-7} \times (4000)^2$$

$$= 1.90 \text{ mm} \quad \dots(2)$$

Deflection due to creep,

$$a_{cc(\text{perm})} = a_{icc(\text{perm})} - a_i(\text{perm})$$

In the absence of data, the age at loading is assumed to be 28 days and the value of creep coefficient,  $\theta$  is taken as 1.6 from 5.2.5.1 of the Code.

$$E_{cc} = \frac{E_c}{1 + \theta}$$

$$= \frac{22.1 \times 10^3}{1 + 1.6} = 8.5 \times 10^3 \text{ N/mm}^2$$

$$m = \frac{E_s}{E_{cc}} = \frac{2 \times 10^5}{8.5 \times 10^3} = 23.53$$

$$p_t = 1.117, p_c = 0.418$$

$$p_c(m-1)/(p_t m) = \frac{0.418(23.53-1)}{(1.117 \times 23.53)} = 0.358$$

Referring to Table 87,

$$I_r / (bd^3 / 12) = 1.497$$

$$I_r = 1.497 \times 300 (562.5)^3 / 12$$

$$= 6.66 \times 10^9 \text{ mm}^4$$

$$I_r \leq I_{\text{eff}} \leq I_{gr}$$

$$6.66 \times 10^9 \leq I_{\text{eff}} \leq 5.4 \times 10^9$$

$$\therefore I_{\text{eff}} = 5.4 \times 10^9 \text{ mm}^4$$

$a_{icc(\text{perm})}$  = Initial plus creep deflection due to permanent loads obtained using the above modulus of elasticity

$$= \frac{1}{4} \frac{Ml^2}{E_{cc} I_{\text{eff}}}$$

$$= \frac{1}{4} \times \frac{(0.6 \times 21 \times 10^7) (4000)^2}{8.5 \times 10^3 \times 5.4 \times 10^9}$$

$$= 10.98 \text{ mm}$$

$a_i(\text{perm})$  = Short term deflection due to permanent load obtained using  $E_c$

$$= \frac{1}{4} \times \frac{(0.6 \times 21 \times 10^7) (4000)^2}{22.1 \times 10^3 \times 3.204 \times 10^9}$$

$$= 7.12 \text{ mm}$$

$$\therefore a_{cc(\text{perm})} = 10.98 - 7.12 = 3.86 \quad \dots(3)$$

$\therefore$  Total deflection (long term) due to initial load, shrinkage and creep

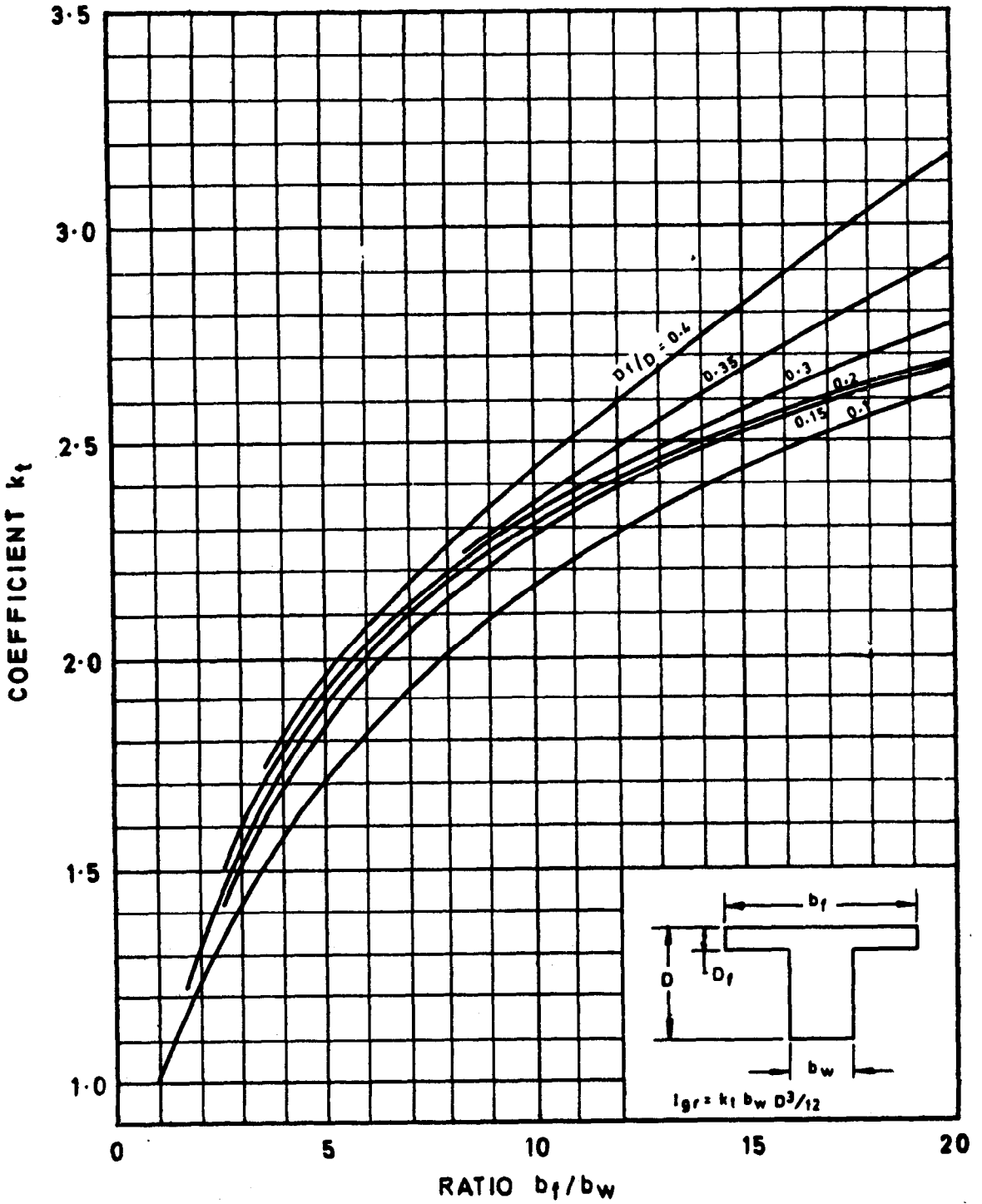
$$= 11.86 + 1.90 + 3.86 = 17.62 \text{ mm.}$$

According to 22.2(a) of the Code the final deflection should not exceed span/250.

$$\text{Permissible deflection} = \frac{4000}{250} = 16 \text{ mm.}$$

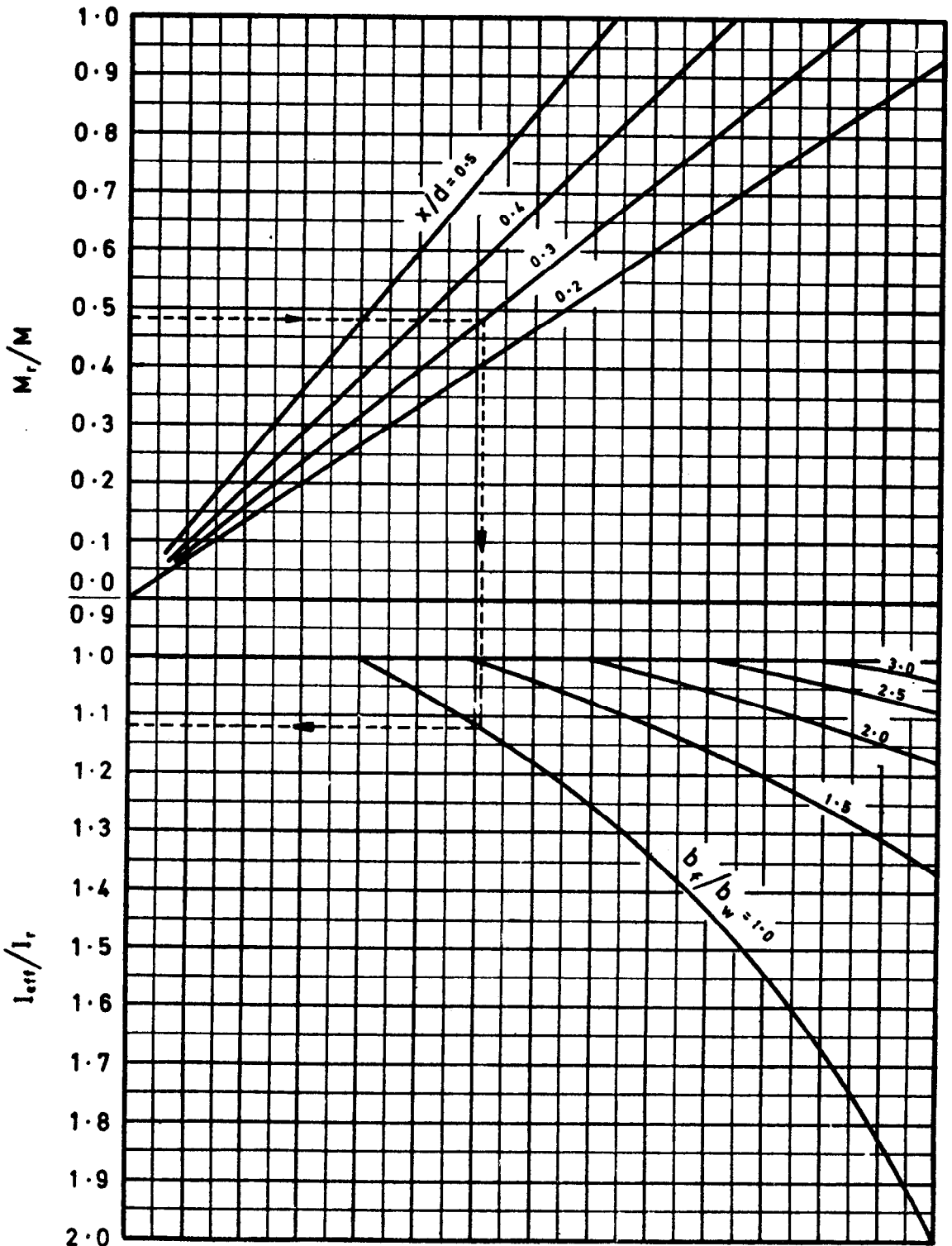
The calculated deflection is only slightly greater than the permissible value and hence the section may not be revised.

# Chart 88 MOMENT OF INERTIA OF T - BEAMS

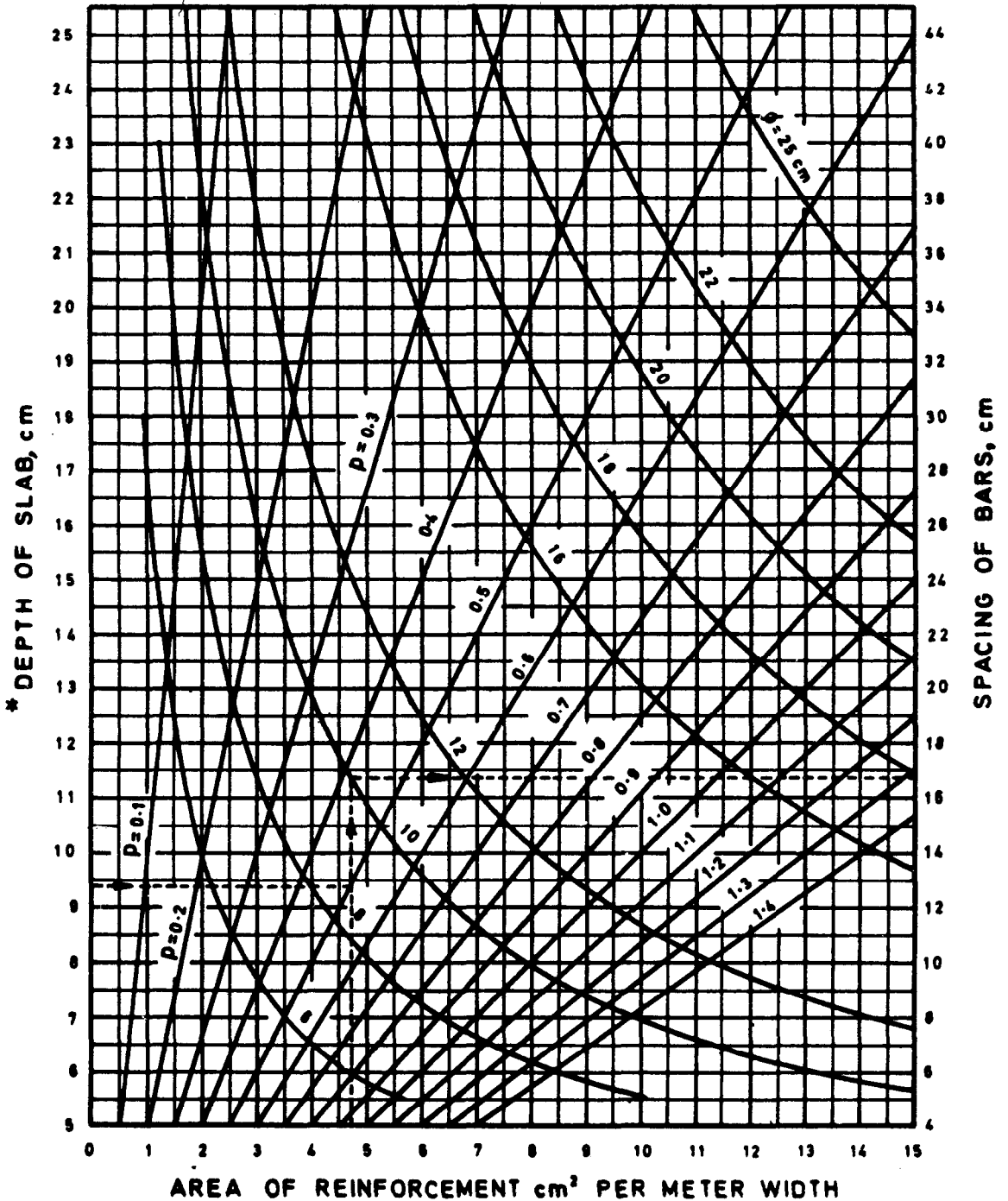




# Chart 89 EFFECTIVE MOMENT OF INERTIA FOR CALCULATING DEFLECTION

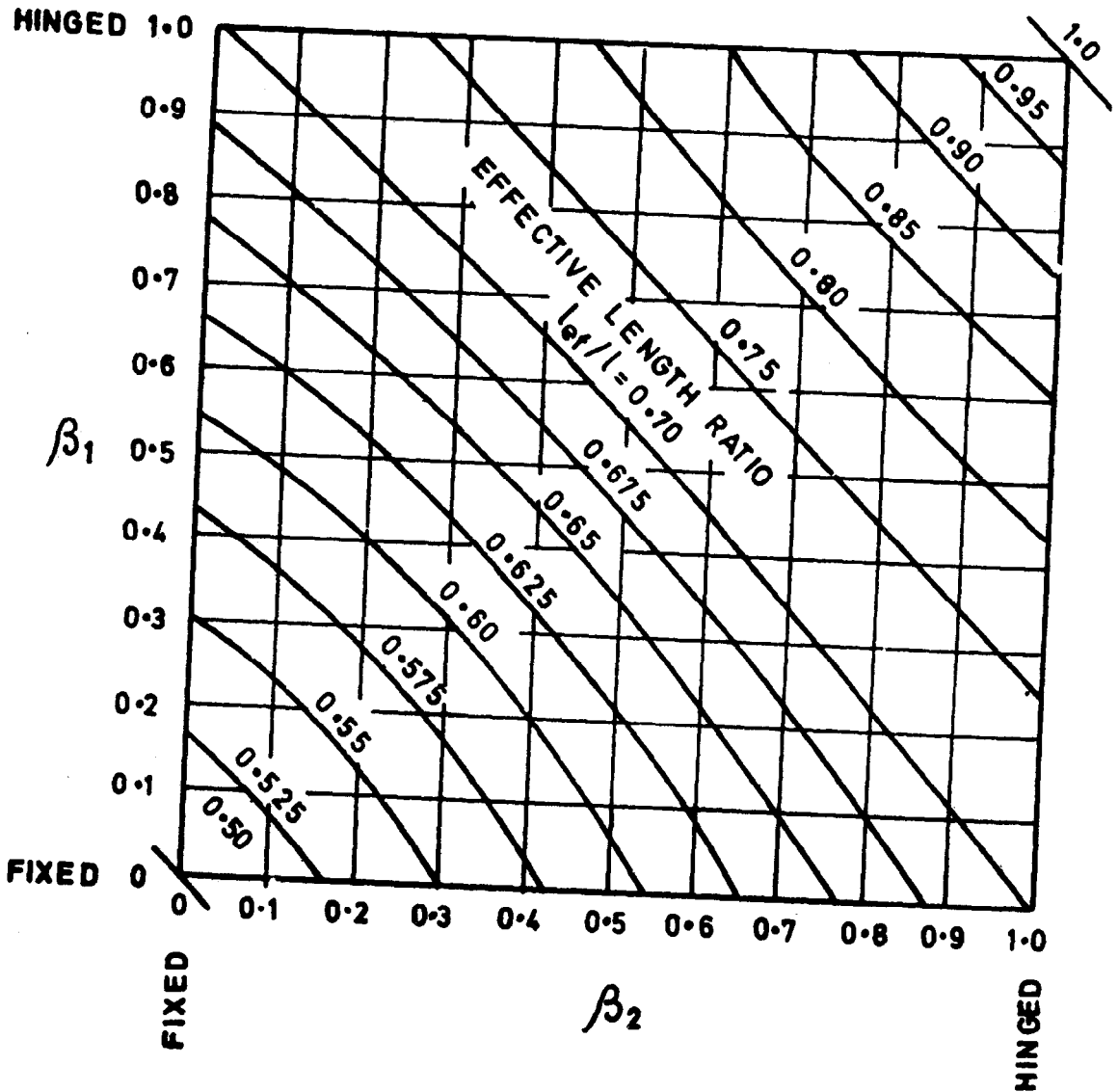


# Chart 90 PERCENTAGE, AREA AND SPACING OF BARS IN SLABS IN SLABS



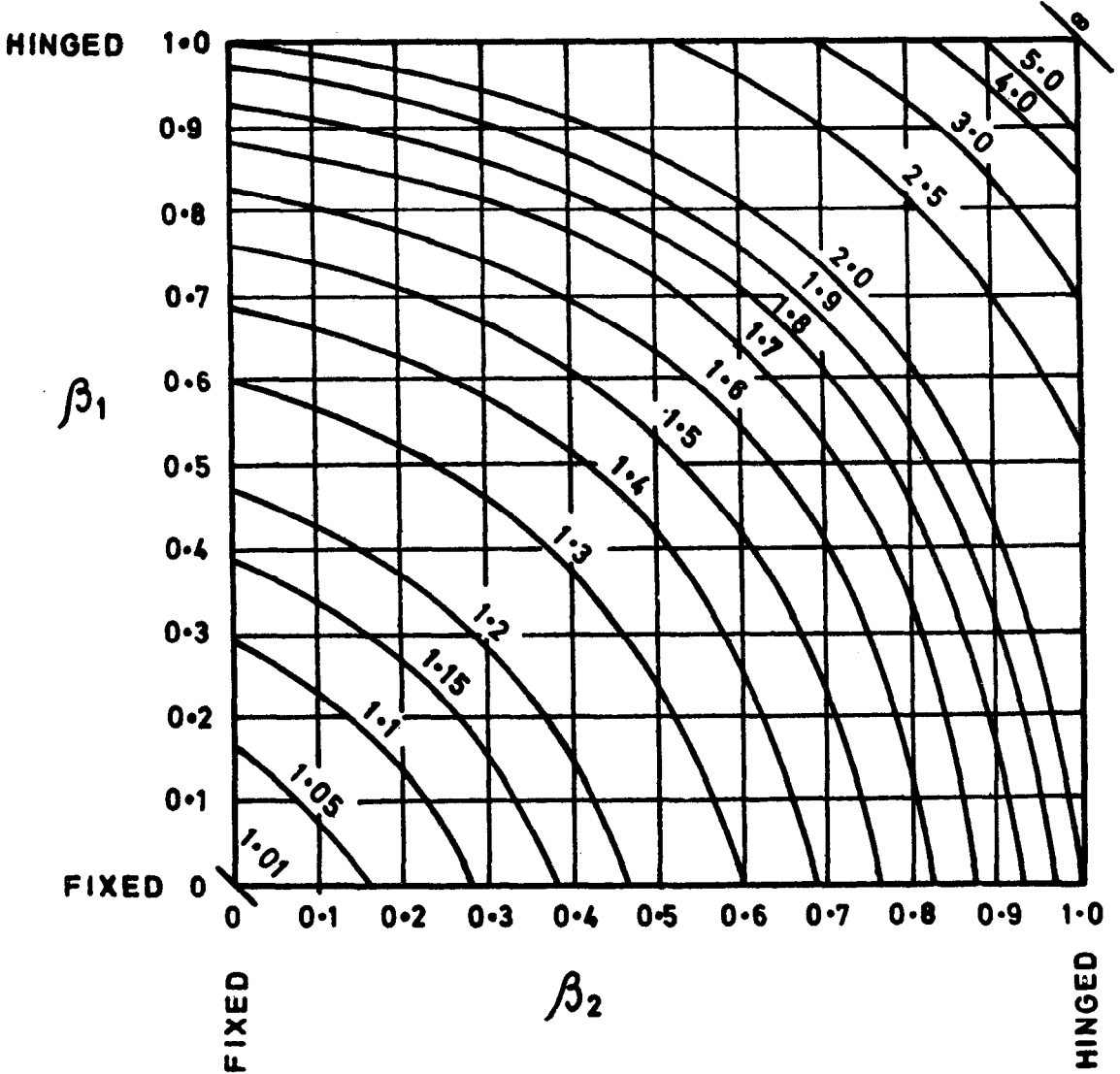
\* USE EFFECTIVE DEPTH OR OVERALL WHICHEVER IS USED FOR CALCULATING P

**Chart 91 EFFECTIVE LENGTH OF COLUMNS –  
Frame Restrained Against Sway**



$\beta_1$  and  $\beta_2$  are the values of  $\beta$  at the top and bottom of the column where,  $\beta = \frac{\sum K_c}{\sum K_c + \sum K_b}$ , the summation being done for the members framing into a joint;  $K_c$  and  $K_b$  are the flexural stiffnesses of column and beam respectively.

**Chart 92 EFFECTIVE LENGTH OF COLUMNS —  
Frame Without Restraint to Sway**



$\beta_1$  and  $\beta_2$  are the values of  $\beta$  at the top and bottom of the column, where  $\beta = \frac{\sum K_c}{\sum K_c + \sum K_b}$ , the summation being done for the members framing into a joint;  $K_c$  and  $K_b$  are the flexural stiffnesses of column and beam respectively.

TABLE 86 MOMENT OF INERTIA — VALUES OF  $bd^3/12\ 000$

$d, \text{ cm}$	$b, \text{ cm}$								
	10	15	20	25	30	35	40	45	50
10	0.8	1.2	1.7	2.1	2.5	2.9	3.3	3.7	4.2
11	1.1	1.7	2.2	2.8	3.3	3.9	4.4	5.0	5.5
12	1.4	2.2	2.9	3.6	4.3	5.0	5.8	6.5	7.2
13	1.8	2.7	3.7	4.6	5.5	6.4	7.3	8.2	9.2
14	2.3	3.4	4.6	5.7	6.9	8.0	9.1	10.3	11.4
15	2.8	4.2	5.6	7.0	8.4	9.8	11.3	12.7	14.1
16	3.4	5.1	6.8	8.5	10.2	11.9	13.7	15.4	17.1
17	4.1	6.1	8.2	10.2	12.3	14.3	16.4	18.4	20.5
18	4.9	7.3	9.7	12.1	14.6	17.0	19.4	21.9	24.3
19	5.7	8.6	11.4	14.3	17.1	20.0	22.9	25.7	28.6
20	6.7	10.0	13.3	16.7	20.0	23.3	26.7	30.0	33.3
21	7.7	11.6	15.4	19.3	23.2	27.0	30.9	34.7	38.6
22	8.9	13.3	17.7	22.2	26.6	31.1	35.5	39.9	44.4
23	10.1	15.2	20.3	25.3	30.4	35.5	40.6	45.6	50.7
24	11.5	17.3	23.0	28.8	34.6	40.3	46.1	51.8	57.6
25	13.0	19.5	26.0	32.6	39.1	45.6	52.1	58.6	65.1
26	14.6	22.0	29.3	36.6	43.9	51.3	58.6	65.9	73.2
27	16.4	24.6	32.8	41.0	49.2	57.4	65.6	73.8	82.0
28	18.3	27.4	36.6	45.7	54.9	64.0	73.2	82.3	91.5
29	20.3	30.5	40.6	50.8	61.0	71.1	81.3	91.5	101.6
30	22.5	33.8	45.0	56.3	67.5	78.8	90.0	101.3	112.5
32	27.3	41.0	54.6	68.3	81.9	95.6	109.2	122.9	136.5
34	32.8	49.1	65.5	81.9	98.3	114.6	131.0	147.4	163.8
36	38.9	58.3	77.8	97.2	116.6	136.1	155.5	175.0	194.4
38	45.7	68.6	91.5	114.3	137.2	160.0	182.9	205.8	228.6
40	53.3	80.0	106.7	133.3	160.0	186.7	213.3	240.0	266.7
42	61.7	92.6	123.5	154.3	185.2	216.1	247.0	277.8	308.7
44	71.0	106.5	142.0	177.5	213.0	248.5	283.9	319.4	354.9
46	81.1	121.7	162.2	202.8	243.3	283.9	324.5	365.0	405.6
48	92.2	138.2	184.3	230.4	276.5	322.6	368.6	414.7	460.8
50	104.2	156.2	208.3	260.4	312.5	364.6	416.7	468.7	520.8
52	117.2	175.8	234.3	292.9	351.5	410.1	468.7	527.3	585.9
54	131.2	196.8	262.4	328.0	393.7	459.3	524.9	590.5	656.1
56	146.3	219.5	292.7	365.9	439.0	512.2	585.4	658.6	731.7
58	162.6	243.9	325.2	406.5	487.8	569.1	650.4	731.7	813.0
60	180.0	270.0	360.0	450.0	540.0	630.0	720.0	810.0	900.0
65	228.9	343.3	457.7	572.1	686.6	801.0	915.4	1029.8	1144.3
70	285.8	428.7	571.7	714.6	857.5	1000.4	1143.3	1286.2	1429.2
75	351.6	527.3	703.1	878.9	1054.7	1230.5	1406.3	1582.0	1757.8
80	426.7	640.0	853.3	1066.7	1280.0	1493.3	1706.7	1920.0	2133.3
85	511.8	767.7	1023.5	1279.4	1535.3	1791.2	2047.1	2303.0	2558.9
90	607.5	911.3	1215.0	1518.8	1822.5	2126.3	2430.0	2733.8	3037.5
95	714.5	1071.7	1429.0	1786.2	2143.4	2500.7	2857.9	3215.2	3572.4
100	833.3	1250.0	1666.7	2083.3	2500.0	2916.7	3333.3	3750.0	4166.7

TABLE 87 MOMENT OF INERTIA OF CRACKED SECTION —

VALUES OF  $I_r / \left( \frac{bd^3}{12} \right)$

$d'/d=0.05$

$p_1 m$	$\rho c(m-1)/(p_1 m)$							
	0.0	0.1	0.2	0.3	0.4	0.6	0.8	1.0
1.0	0.100	0.100	0.100	0.100	0.100	0.100	0.100	0.100
1.5	0.143	0.144	0.144	0.144	0.144	0.145	0.145	0.145
2.0	0.185	0.185	0.186	0.186	0.186	0.187	0.188	0.188
2.5	0.224	0.225	0.225	0.226	0.227	0.228	0.229	0.230
3.0	0.262	0.263	0.264	0.264	0.265	0.267	0.269	0.270
3.5	0.298	0.299	0.300	0.302	0.303	0.305	0.308	0.310
4.0	0.332	0.334	0.336	0.338	0.339	0.343	0.346	0.348
4.5	0.366	0.368	0.371	0.373	0.375	0.379	0.383	0.386
5.0	0.398	0.401	0.404	0.407	0.409	0.414	0.419	0.424
5.5	0.430	0.433	0.437	0.440	0.443	0.449	0.455	0.460
6.0	0.460	0.465	0.469	0.472	0.476	0.483	0.490	0.496
6.5	0.490	0.495	0.500	0.504	0.509	0.517	0.525	0.532
7.0	0.519	0.525	0.530	0.535	0.540	0.550	0.559	0.567
7.5	0.547	0.554	0.560	0.566	0.571	0.582	0.592	0.602
8.0	0.575	0.582	0.589	0.596	0.602	0.614	0.626	0.636
8.5	0.601	0.610	0.617	0.625	0.632	0.646	0.659	0.670
9.0	0.628	0.637	0.645	0.654	0.662	0.677	0.691	0.704
9.5	0.653	0.663	0.673	0.682	0.691	0.708	0.723	0.738
10.0	0.678	0.689	0.700	0.710	0.720	0.738	0.755	0.771
10.5	0.703	0.715	0.727	0.738	0.748	0.769	0.787	0.804
11.0	0.727	0.740	0.753	0.765	0.777	0.798	0.818	0.837
11.5	0.750	0.764	0.778	0.792	0.804	0.828	0.850	0.869
12.0	0.773	0.789	0.804	0.818	0.832	0.857	0.880	0.902
12.5	0.795	0.812	0.829	0.844	0.859	0.886	0.911	0.934
13.0	0.818	0.836	0.853	0.870	0.885	0.915	0.942	0.966
13.5	0.839	0.859	0.877	0.895	0.912	0.943	0.972	0.998
14.0	0.860	0.881	0.901	0.920	0.938	0.972	1.002	1.030
14.5	0.881	0.904	0.925	0.945	0.964	1.000	1.032	1.061
15.0	0.902	0.926	0.948	0.969	0.990	1.027	1.062	1.093
15.5	0.922	0.947	0.971	0.994	1.015	1.055	1.091	1.124
16.0	0.942	0.968	0.994	1.018	1.040	1.083	1.121	1.155
17.0	0.980	1.010	1.038	1.065	1.090	1.137	1.179	1.217
18.0	1.018	1.051	1.082	1.111	1.139	1.191	1.237	1.278
19.0	1.054	1.090	1.125	1.157	1.188	1.244	1.294	1.340
20.0	1.089	1.129	1.166	1.202	1.235	1.296	1.351	1.400
21.0	1.123	1.167	1.207	1.246	1.282	1.348	1.408	1.461
22.0	1.156	1.203	1.248	1.289	1.328	1.400	1.464	1.521
23.0	1.188	1.239	1.287	1.332	1.374	1.451	1.519	1.581
24.0	1.220	1.274	1.326	1.374	1.419	1.502	1.575	1.640
25.0	1.250	1.309	1.364	1.415	1.464	1.552	1.630	1.699
26.0	1.280	1.342	1.401	1.456	1.508	1.602	1.685	1.758
27.0	1.308	1.376	1.438	1.497	1.552	1.651	1.739	1.817
28.0	1.337	1.408	1.475	1.537	1.595	1.701	1.794	1.876
29.0	1.364	1.440	1.510	1.576	1.638	1.750	1.848	1.934
30.0	1.391	1.471	1.546	1.615	1.681	1.798	1.902	1.993



TABLE 88 MOMENT OF INERTIA OF CRACKED SECTION —

VALUES OF  $I_{cr} \left( \frac{hd^3}{12} \right)$

$d'/d=0.10$

$p, m$	$p_c(m-1)/(p, m)$							
	0.0	0.1	0.2	0.3	0.4	0.6	0.8	1.0
1.0	0.100	0.100	0.100	0.100	0.100	0.100	0.100	0.100
1.5	0.143	0.143	0.144	0.144	0.144	0.144	0.144	0.144
2.0	0.185	0.185	0.185	0.185	0.185	0.186	0.186	0.186
2.5	0.224	0.224	0.225	0.225	0.225	0.226	0.226	0.227
3.0	0.262	0.262	0.263	0.263	0.263	0.264	0.265	0.266
3.5	0.298	0.298	0.299	0.300	0.300	0.302	0.303	0.304
4.0	0.332	0.333	0.334	0.335	0.336	0.338	0.340	0.341
4.5	0.366	0.367	0.369	0.370	0.371	0.373	0.376	0.378
5.0	0.398	0.400	0.402	0.403	0.405	0.408	0.411	0.413
5.5	0.430	0.432	0.434	0.436	0.438	0.442	0.445	0.448
6.0	0.460	0.463	0.466	0.468	0.470	0.475	0.479	0.483
6.5	0.490	0.493	0.496	0.499	0.502	0.507	0.512	0.517
7.0	0.519	0.523	0.526	0.530	0.533	0.539	0.545	0.550
7.5	0.547	0.551	0.556	0.560	0.563	0.571	0.577	0.583
8.0	0.575	0.580	0.584	0.589	0.593	0.601	0.609	0.616
8.5	0.601	0.607	0.612	0.618	0.622	0.632	0.640	0.648
9.0	0.628	0.634	0.640	0.646	0.651	0.662	0.671	0.680
9.5	0.653	0.660	0.667	0.673	0.680	0.691	0.702	0.712
10.0	0.678	0.686	0.693	0.701	0.708	0.720	0.732	0.743
10.5	0.703	0.711	0.720	0.727	0.735	0.749	0.762	0.774
11.0	0.727	0.736	0.745	0.754	0.762	0.778	0.792	0.805
11.5	0.750	0.760	0.770	0.780	0.789	0.806	0.822	0.836
12.0	0.773	0.784	0.795	0.805	0.815	0.834	0.851	0.866
12.5	0.795	0.808	0.820	0.831	0.841	0.861	0.880	0.896
13.0	0.818	0.831	0.844	0.856	0.867	0.889	0.908	0.926
13.5	0.839	0.854	0.867	0.880	0.893	0.916	0.937	0.956
14.0	0.860	0.876	0.891	0.905	0.918	0.943	0.965	0.986
14.5	0.881	0.898	0.914	0.929	0.943	0.969	0.993	1.015
15.0	0.902	0.920	0.936	0.952	0.968	0.996	1.021	1.044
15.5	0.922	0.941	0.959	0.976	0.992	1.022	1.049	1.074
16.0	0.942	0.962	0.981	0.999	1.016	1.048	1.077	1.103
17.0	0.980	1.003	1.024	1.045	1.064	1.099	1.131	1.160
18.0	1.018	1.043	1.067	1.089	1.111	1.150	1.185	1.217
19.0	1.054	1.082	1.108	1.133	1.157	1.200	1.239	1.274
20.0	1.089	1.120	1.149	1.176	1.202	1.249	1.292	1.330
21.0	1.123	1.157	1.189	1.218	1.247	1.298	1.344	1.386
22.0	1.156	1.193	1.227	1.260	1.291	1.347	1.396	1.441
23.0	1.188	1.228	1.266	1.301	1.334	1.394	1.448	1.496
24.0	1.220	1.263	1.303	1.341	1.377	1.442	1.500	1.551
25.0	1.250	1.296	1.340	1.381	1.419	1.489	1.551	1.606
26.0	1.280	1.329	1.376	1.420	1.461	1.535	1.601	1.660
27.0	1.308	1.362	1.412	1.458	1.502	1.582	1.652	1.714
28.0	1.337	1.394	1.447	1.496	1.543	1.627	1.702	1.768
29.0	1.364	1.425	1.481	1.534	1.583	1.673	1.752	1.821
30.0	1.391	1.455	1.515	1.571	1.623	1.718	1.801	1.875

TABLE 89 MOMENT OF INERTIA OF CRACKED SECTION —

$$\text{VALUES OF } I_r \left( \frac{bd^3}{12} \right)$$

$d'/d=0.15$

$p, m$	$P_c(m-1)/(p, m)$							
	0.0	0.1	0.2	0.3	0.4	0.6	0.8	1.0
1.0	0.100	0.100	0.100	0.100	0.100	0.100	0.100	0.100
1.5	0.143	0.143	0.143	0.143	0.143	0.143	0.143	0.143
2.0	0.185	0.185	0.185	0.185	0.185	0.185	0.185	0.185
2.5	0.224	0.224	0.224	0.224	0.224	0.224	0.225	0.225
3.0	0.262	0.262	0.262	0.262	0.262	0.262	0.263	0.263
3.5	0.298	0.298	0.298	0.298	0.299	0.299	0.300	0.300
4.0	0.332	0.333	0.333	0.334	0.334	0.335	0.336	0.336
4.5	0.366	0.367	0.367	0.368	0.368	0.369	0.371	0.372
5.0	0.398	0.399	0.400	0.401	0.402	0.403	0.405	0.406
5.5	0.430	0.431	0.432	0.433	0.434	0.436	0.438	0.440
6.0	0.460	0.462	0.463	0.465	0.466	0.468	0.471	0.473
6.5	0.490	0.492	0.494	0.495	0.497	0.500	0.503	0.505
7.0	0.519	0.521	0.523	0.525	0.527	0.531	0.534	0.537
7.5	0.547	0.550	0.552	0.555	0.557	0.561	0.565	0.569
8.0	0.575	0.578	0.581	0.583	0.586	0.591	0.596	0.600
8.5	0.601	0.605	0.608	0.611	0.614	0.620	0.626	0.631
9.0	0.628	0.632	0.635	0.639	0.643	0.649	0.655	0.661
9.5	0.653	0.658	0.662	0.666	0.670	0.678	0.685	0.691
10.0	0.678	0.683	0.688	0.693	0.697	0.706	0.713	0.721
10.5	0.703	0.708	0.714	0.719	0.724	0.733	0.742	0.750
11.0	0.727	0.733	0.739	0.745	0.750	0.761	0.770	0.779
11.5	0.750	0.757	0.764	0.770	0.776	0.788	0.798	0.808
12.0	0.773	0.781	0.788	0.795	0.802	0.814	0.826	0.836
12.5	0.795	0.804	0.812	0.820	0.827	0.841	0.853	0.865
13.0	0.818	0.827	0.836	0.844	0.852	0.867	0.880	0.893
13.5	0.839	0.849	0.859	0.868	0.876	0.893	0.907	0.921
14.0	0.860	0.871	0.882	0.891	0.901	0.918	0.934	0.948
14.5	0.881	0.893	0.904	0.915	0.925	0.943	0.960	0.976
15.0	0.902	0.914	0.926	0.938	0.949	0.969	0.987	1.003
15.5	0.922	0.935	0.948	0.960	0.972	0.993	1.013	1.030
16.0	0.942	0.956	0.970	0.983	0.995	1.018	1.039	1.057
17.0	0.980	0.997	1.012	1.027	1.041	1.067	1.090	1.111
18.0	1.018	1.036	1.054	1.070	1.086	1.115	1.141	1.164
19.0	1.054	1.075	1.094	1.112	1.130	1.162	1.191	1.216
20.0	1.089	1.112	1.134	1.154	1.173	1.208	1.240	1.268
21.0	1.123	1.148	1.172	1.194	1.216	1.254	1.289	1.320
22.0	1.156	1.184	1.210	1.234	1.257	1.300	1.337	1.371
23.0	1.188	1.219	1.247	1.274	1.299	1.345	1.385	1.422
24.0	1.220	1.252	1.283	1.312	1.339	1.389	1.433	1.473
25.0	1.250	1.286	1.319	1.350	1.379	1.433	1.480	1.523
26.0	1.280	1.318	1.354	1.387	1.419	1.476	1.527	1.573
27.0	1.308	1.350	1.388	1.424	1.458	1.520	1.574	1.622
28.0	1.337	1.381	1.422	1.461	1.497	1.562	1.620	1.672
29.0	1.364	1.411	1.455	1.496	1.535	1.605	1.666	1.721
30.0	1.391	1.441	1.488	1.532	1.573	1.647	1.712	1.770

TABLE 90 MOMENT OF INERTIA OF CRACKED SECTION —

$$\text{VALUES OF } I_r / \left( \frac{bd^3}{12} \right)$$

$d'/d=0.20$

$p_t/m$	$\rho_c(m-1)/(p_t/m)$							
	0.0	0.1	0.2	0.3	0.4	0.6	0.8	1.0
1.0	0.100	0.100	0.100	0.100	0.100	0.100	0.100	0.100
1.5	0.143	0.143	0.143	0.143	0.144	0.144	0.144	0.144
2.0	0.185	0.185	0.185	0.185	0.185	0.185	0.185	0.185
2.5	0.224	0.224	0.224	0.224	0.224	0.224	0.224	0.224
3.0	0.262	0.262	0.262	0.262	0.262	0.262	0.262	0.262
3.5	0.298	0.298	0.298	0.298	0.298	0.298	0.298	0.298
4.0	0.332	0.333	0.333	0.333	0.333	0.333	0.333	0.333
4.5	0.366	0.366	0.366	0.367	0.367	0.367	0.367	0.368
5.0	0.398	0.399	0.399	0.399	0.400	0.400	0.401	0.401
5.5	0.430	0.430	0.431	0.431	0.432	0.432	0.433	0.434
6.0	0.460	0.461	0.462	0.462	0.463	0.464	0.465	0.466
6.5	0.490	0.491	0.492	0.492	0.493	0.495	0.496	0.497
7.0	0.519	0.520	0.521	0.522	0.523	0.525	0.526	0.528
7.5	0.547	0.548	0.550	0.551	0.552	0.554	0.556	0.558
8.0	0.575	0.576	0.578	0.579	0.580	0.583	0.586	0.588
8.5	0.601	0.603	0.605	0.607	0.608	0.612	0.614	0.617
9.0	0.628	0.630	0.632	0.634	0.636	0.639	0.643	0.646
9.5	0.653	0.656	0.658	0.660	0.663	0.667	0.671	0.675
10.0	0.678	0.681	0.684	0.687	0.689	0.694	0.699	0.703
10.5	0.703	0.706	0.709	0.712	0.715	0.721	0.726	0.731
11.0	0.727	0.730	0.734	0.737	0.741	0.747	0.753	0.758
11.5	0.750	0.754	0.758	0.762	0.766	0.773	0.779	0.785
12.0	0.773	0.778	0.782	0.787	0.791	0.799	0.806	0.812
12.5	0.795	0.801	0.806	0.811	0.815	0.824	0.832	0.839
13.0	0.818	0.823	0.829	0.834	0.839	0.849	0.857	0.865
13.5	0.839	0.846	0.852	0.858	0.863	0.874	0.883	0.892
14.0	0.860	0.867	0.874	0.881	0.887	0.898	0.908	0.918
14.5	0.881	0.889	0.896	0.903	0.910	0.922	0.933	0.943
15.0	0.902	0.910	0.918	0.926	0.933	0.946	0.958	0.969
15.5	0.922	0.931	0.940	0.948	0.955	0.970	0.983	0.994
16.0	0.942	0.952	0.961	0.969	0.978	0.993	1.007	1.020
17.0	0.980	0.992	1.002	1.012	1.022	1.039	1.055	1.070
18.0	1.018	1.031	1.043	1.054	1.065	1.085	1.103	1.119
19.0	1.054	1.068	1.082	1.095	1.107	1.129	1.150	1.168
20.0	1.089	1.105	1.120	1.135	1.148	1.173	1.196	1.216
21.0	1.123	1.141	1.158	1.174	1.189	1.217	1.241	1.264
22.0	1.156	1.176	1.195	1.212	1.229	1.259	1.287	1.311
23.0	1.188	1.210	1.231	1.250	1.268	1.302	1.331	1.358
24.0	1.220	1.244	1.266	1.287	1.307	1.343	1.376	1.405
25.0	1.250	1.276	1.301	1.324	1.345	1.384	1.419	1.451
26.0	1.280	1.308	1.334	1.359	1.383	1.425	1.463	1.497
27.0	1.308	1.339	1.368	1.395	1.420	1.465	1.506	1.542
28.0	1.337	1.370	1.400	1.429	1.456	1.505	1.549	1.587
29.0	1.364	1.399	1.433	1.463	1.492	1.545	1.591	1.632
30.0	1.391	1.429	1.464	1.497	1.528	1.584	1.633	1.677

TABLE 91 DEPTH OF NEUTRAL AXES — VALUES OF  $x/d$   
BY ELASTIC THEORY

$d'/d=0.05$

$p_1 m$	$p_0(m-1)/(p_1 m)$							
	0.0	0.1	0.2	0.3	0.4	0.6	0.8	1.0
1.0	0.132	0.131	0.131	0.130	0.130	0.128	0.127	0.126
1.5	0.159	0.158	0.157	0.156	0.155	0.153	0.152	0.150
2.0	0.181	0.180	0.178	0.177	0.176	0.173	0.171	0.169
2.5	0.200	0.198	0.197	0.195	0.194	0.190	0.187	0.185
3.0	0.217	0.215	0.213	0.211	0.209	0.205	0.202	0.198
3.5	0.232	0.230	0.227	0.225	0.223	0.218	0.214	0.210
4.0	0.246	0.243	0.240	0.238	0.235	0.230	0.225	0.221
4.5	0.258	0.255	0.252	0.249	0.246	0.241	0.235	0.230
5.0	0.270	0.267	0.263	0.260	0.257	0.251	0.245	0.239
5.5	0.281	0.277	0.274	0.270	0.267	0.260	0.253	0.247
6.0	0.292	0.287	0.284	0.280	0.276	0.268	0.261	0.255
6.5	0.301	0.297	0.293	0.288	0.284	0.276	0.269	0.262
7.0	0.311	0.306	0.301	0.297	0.292	0.284	0.276	0.268
7.5	0.319	0.314	0.309	0.305	0.300	0.291	0.282	0.274
8.0	0.328	0.323	0.317	0.312	0.307	0.298	0.289	0.280
8.5	0.336	0.330	0.325	0.319	0.314	0.304	0.294	0.285
9.0	0.344	0.338	0.332	0.326	0.321	0.310	0.300	0.291
9.5	0.351	0.345	0.339	0.333	0.327	0.316	0.305	0.295
10.0	0.358	0.352	0.345	0.339	0.333	0.321	0.310	0.300
10.5	0.365	0.358	0.351	0.345	0.339	0.326	0.315	0.304
11.0	0.372	0.365	0.358	0.351	0.344	0.332	0.320	0.309
11.5	0.378	0.371	0.363	0.356	0.349	0.336	0.324	0.313
12.0	0.384	0.377	0.369	0.362	0.355	0.341	0.328	0.316
12.5	0.390	0.382	0.374	0.367	0.359	0.345	0.332	0.320
13.0	0.396	0.388	0.380	0.372	0.364	0.350	0.336	0.324
13.5	0.402	0.393	0.385	0.377	0.369	0.354	0.340	0.327
14.0	0.407	0.398	0.390	0.381	0.373	0.358	0.344	0.330
14.5	0.413	0.403	0.394	0.386	0.378	0.362	0.347	0.333
15.0	0.418	0.408	0.399	0.390	0.382	0.365	0.350	0.336
15.5	0.423	0.413	0.404	0.395	0.386	0.369	0.354	0.339
16.0	0.428	0.418	0.408	0.399	0.390	0.373	0.357	0.342
17.0	0.437	0.427	0.416	0.407	0.397	0.379	0.363	0.347
18.0	0.446	0.435	0.425	0.414	0.404	0.386	0.368	0.352
19.0	0.455	0.443	0.432	0.421	0.411	0.392	0.374	0.357
20.0	0.463	0.451	0.439	0.428	0.417	0.397	0.379	0.362
21.0	0.471	0.459	0.446	0.435	0.424	0.403	0.383	0.366
22.0	0.479	0.466	0.453	0.441	0.429	0.408	0.388	0.370
23.0	0.486	0.472	0.459	0.447	0.435	0.413	0.392	0.373
24.0	0.493	0.479	0.465	0.453	0.440	0.417	0.396	0.377
25.0	0.500	0.485	0.471	0.458	0.445	0.422	0.400	0.380
26.0	0.507	0.491	0.477	0.463	0.450	0.426	0.404	0.384
27.0	0.513	0.497	0.482	0.468	0.455	0.430	0.407	0.387
28.0	0.519	0.503	0.488	0.473	0.459	0.434	0.411	0.390
29.0	0.525	0.508	0.493	0.478	0.464	0.437	0.414	0.392
30.0	0.531	0.514	0.498	0.482	0.468	0.441	0.417	0.395

TABLE 92 DEPTH OF NEUTRAL AXIS — VALUES OF  $x/d$   
BY ELASTIC THEORY

$d'/d=0.10$

$p_1 m$	$\rho_c(m-1)/(p_1 m)$							
	0.0	0.1	0.2	0.3	0.4	0.6	0.8	1.0
1.0	0.132	0.132	0.131	0.131	0.131	0.130	0.130	0.130
1.5	0.159	0.158	0.158	0.157	0.157	0.156	0.155	0.154
2.0	0.181	0.180	0.179	0.179	0.178	0.176	0.175	0.174
2.5	0.200	0.199	0.198	0.197	0.196	0.194	0.192	0.190
3.0	0.217	0.215	0.214	0.213	0.211	0.209	0.206	0.204
3.5	0.232	0.230	0.228	0.227	0.225	0.222	0.219	0.216
4.0	0.246	0.244	0.242	0.240	0.238	0.234	0.231	0.227
4.5	0.258	0.256	0.254	0.252	0.249	0.245	0.241	0.237
5.0	0.270	0.268	0.265	0.262	0.260	0.255	0.251	0.246
5.5	0.281	0.278	0.275	0.273	0.270	0.265	0.260	0.255
6.0	0.292	0.288	0.285	0.282	0.279	0.273	0.268	0.263
6.5	0.301	0.298	0.294	0.291	0.288	0.282	0.276	0.270
7.0	0.311	0.307	0.303	0.299	0.296	0.289	0.283	0.277
7.5	0.319	0.315	0.311	0.307	0.304	0.296	0.290	0.283
8.0	0.328	0.324	0.319	0.315	0.311	0.303	0.296	0.289
8.5	0.336	0.331	0.327	0.322	0.318	0.310	0.302	0.295
9.0	0.344	0.339	0.334	0.329	0.325	0.316	0.308	0.300
9.5	0.351	0.346	0.341	0.336	0.331	0.322	0.313	0.305
10.0	0.358	0.353	0.347	0.342	0.337	0.327	0.318	0.310
10.5	0.365	0.359	0.354	0.348	0.343	0.333	0.323	0.314
11.0	0.372	0.366	0.360	0.354	0.349	0.338	0.328	0.319
11.5	0.378	0.372	0.366	0.360	0.354	0.343	0.333	0.323
12.0	0.384	0.378	0.371	0.365	0.359	0.348	0.337	0.327
12.5	0.390	0.383	0.377	0.370	0.364	0.352	0.341	0.331
13.0	0.396	0.389	0.382	0.375	0.369	0.357	0.345	0.335
13.5	0.402	0.394	0.387	0.380	0.374	0.361	0.349	0.338
14.0	0.407	0.400	0.392	0.385	0.378	0.365	0.353	0.342
14.5	0.413	0.405	0.397	0.390	0.382	0.369	0.357	0.345
15.0	0.418	0.410	0.402	0.394	0.387	0.373	0.360	0.348
15.5	0.423	0.414	0.406	0.398	0.391	0.377	0.363	0.351
16.0	0.428	0.419	0.411	0.403	0.395	0.380	0.367	0.354
17.0	0.437	0.428	0.419	0.411	0.403	0.387	0.373	0.360
18.0	0.446	0.437	0.427	0.418	0.410	0.394	0.379	0.365
19.0	0.455	0.445	0.435	0.426	0.417	0.400	0.384	0.370
20.0	0.463	0.453	0.442	0.433	0.423	0.406	0.389	0.375
21.0	0.471	0.460	0.449	0.439	0.429	0.411	0.394	0.379
22.0	0.479	0.467	0.456	0.445	0.435	0.416	0.399	0.383
23.0	0.486	0.474	0.462	0.451	0.441	0.421	0.403	0.387
24.0	0.493	0.481	0.469	0.457	0.446	0.426	0.408	0.391
25.0	0.500	0.487	0.475	0.463	0.452	0.431	0.412	0.394
26.0	0.507	0.493	0.480	0.468	0.457	0.435	0.416	0.398
27.0	0.513	0.499	0.486	0.473	0.461	0.439	0.419	0.401
28.0	0.519	0.505	0.491	0.478	0.466	0.443	0.423	0.404
29.0	0.525	0.510	0.496	0.483	0.470	0.447	0.426	0.407
30.0	0.531	0.516	0.501	0.488	0.475	0.451	0.429	0.410

TABLE 93 DEPTH OF NEUTRAL AXIS — VALUES OF  $x/d$   
BY ELASTIC THEORY

$d'/d=0.15$

$p_1 m$	$p_c(m-1)/(p_1 m)$							
	0.0	0.1	0.2	0.3	0.4	0.6	0.8	1.0
1.0	0.132	0.132	0.132	0.132	0.132	0.133	0.133	0.133
1.5	0.159	0.159	0.159	0.159	0.159	0.158	0.158	0.158
2.0	0.181	0.181	0.180	0.180	0.180	0.179	0.179	0.178
2.5	0.200	0.199	0.199	0.198	0.198	0.197	0.196	0.195
3.0	0.217	0.216	0.215	0.214	0.214	0.212	0.211	0.209
3.5	0.232	0.231	0.230	0.229	0.228	0.226	0.224	0.222
4.0	0.246	0.244	0.243	0.242	0.241	0.238	0.236	0.234
4.5	0.258	0.257	0.255	0.254	0.252	0.249	0.247	0.244
5.0	0.270	0.268	0.266	0.265	0.263	0.260	0.257	0.254
5.5	0.281	0.279	0.277	0.275	0.273	0.269	0.266	0.262
6.0	0.292	0.289	0.287	0.285	0.282	0.278	0.274	0.270
6.5	0.301	0.299	0.296	0.294	0.291	0.287	0.282	0.278
7.0	0.311	0.308	0.305	0.302	0.299	0.294	0.290	0.285
7.5	0.319	0.316	0.313	0.310	0.307	0.302	0.297	0.292
8.0	0.328	0.324	0.321	0.318	0.315	0.309	0.303	0.298
8.5	0.336	0.332	0.329	0.325	0.322	0.315	0.309	0.304
9.0	0.344	0.340	0.336	0.332	0.329	0.322	0.315	0.309
9.5	0.351	0.347	0.343	0.339	0.335	0.328	0.321	0.315
10.0	0.358	0.354	0.349	0.345	0.341	0.334	0.326	0.320
10.5	0.365	0.360	0.356	0.351	0.347	0.339	0.332	0.324
11.0	0.372	0.367	0.362	0.357	0.353	0.344	0.336	0.329
11.5	0.378	0.373	0.368	0.363	0.358	0.349	0.341	0.333
12.0	0.384	0.379	0.374	0.369	0.364	0.354	0.346	0.338
12.5	0.390	0.385	0.379	0.374	0.369	0.359	0.350	0.342
13.0	0.396	0.390	0.384	0.379	0.374	0.364	0.354	0.345
13.5	0.402	0.396	0.390	0.384	0.378	0.368	0.358	0.349
14.0	0.407	0.401	0.395	0.389	0.383	0.372	0.362	0.353
14.5	0.413	0.406	0.400	0.393	0.387	0.376	0.366	0.356
15.0	0.418	0.411	0.404	0.398	0.392	0.380	0.369	0.360
15.5	0.423	0.416	0.409	0.402	0.396	0.384	0.373	0.363
16.0	0.428	0.420	0.413	0.407	0.400	0.388	0.376	0.366
17.0	0.437	0.429	0.422	0.415	0.408	0.395	0.383	0.372
18.0	0.446	0.438	0.430	0.422	0.415	0.401	0.389	0.377
19.0	0.455	0.446	0.438	0.430	0.422	0.408	0.395	0.382
20.0	0.463	0.454	0.445	0.437	0.429	0.414	0.400	0.387
21.0	0.471	0.462	0.452	0.444	0.435	0.419	0.405	0.392
22.0	0.479	0.469	0.459	0.450	0.441	0.425	0.410	0.396
23.0	0.486	0.476	0.466	0.456	0.447	0.430	0.415	0.401
24.0	0.493	0.482	0.472	0.462	0.452	0.435	0.419	0.405
25.0	0.500	0.489	0.478	0.468	0.458	0.440	0.423	0.408
26.0	0.507	0.495	0.484	0.473	0.463	0.444	0.427	0.412
27.0	0.513	0.501	0.489	0.478	0.468	0.448	0.431	0.415
28.0	0.519	0.506	0.494	0.483	0.472	0.453	0.435	0.419
29.0	0.525	0.512	0.500	0.488	0.477	0.457	0.438	0.422
30.0	0.531	0.517	0.505	0.493	0.481	0.460	0.442	0.425



TABLE 94 DEPTH OF NEUTRAL AXIS — VALUES OF  $x/d$   
BY ELASTIC THEORY

$d'/d=0.20$

$p_t m$	$\rho_c(m-1)/(p_t m)$							
	0.0	0.1	0.2	0.3	0.4	0.6	0.8	1.0
1.0	0.132	0.132	0.133	0.133	0.134	0.135	0.135	0.136
1.5	0.159	0.159	0.160	0.160	0.160	0.161	0.161	0.162
2.0	0.181	0.181	0.181	0.182	0.182	0.182	0.182	0.183
2.5	0.200	0.200	0.200	0.200	0.200	0.200	0.200	0.200
3.0	0.217	0.217	0.216	0.216	0.216	0.216	0.215	0.215
3.5	0.232	0.231	0.231	0.231	0.230	0.230	0.229	0.228
4.0	0.246	0.245	0.244	0.244	0.243	0.242	0.241	0.240
4.5	0.258	0.258	0.257	0.256	0.255	0.254	0.252	0.251
5.0	0.270	0.269	0.268	0.267	0.266	0.264	0.262	0.261
5.5	0.281	0.280	0.279	0.277	0.276	0.274	0.272	0.270
6.0	0.292	0.290	0.289	0.287	0.286	0.283	0.280	0.278
6.5	0.301	0.300	0.298	0.296	0.295	0.291	0.289	0.286
7.0	0.311	0.309	0.307	0.305	0.303	0.300	0.296	0.293
7.5	0.319	0.317	0.315	0.313	0.311	0.307	0.303	0.300
8.0	0.328	0.325	0.323	0.321	0.319	0.314	0.310	0.306
8.5	0.336	0.333	0.331	0.328	0.326	0.321	0.317	0.313
9.0	0.344	0.341	0.338	0.335	0.333	0.328	0.323	0.318
9.5	0.351	0.348	0.345	0.342	0.339	0.334	0.329	0.324
10.0	0.358	0.355	0.352	0.348	0.345	0.340	0.334	0.329
10.5	0.365	0.362	0.358	0.355	0.351	0.345	0.340	0.334
11.0	0.372	0.368	0.364	0.361	0.357	0.351	0.345	0.339
11.5	0.378	0.374	0.370	0.366	0.363	0.356	0.349	0.343
12.0	0.384	0.380	0.376	0.372	0.368	0.361	0.354	0.348
12.5	0.390	0.386	0.382	0.377	0.373	0.366	0.359	0.352
13.0	0.396	0.391	0.387	0.383	0.378	0.370	0.363	0.356
13.5	0.402	0.397	0.392	0.388	0.383	0.375	0.367	0.360
14.0	0.407	0.402	0.397	0.392	0.388	0.379	0.371	0.364
14.5	0.413	0.407	0.402	0.397	0.392	0.383	0.375	0.367
15.0	0.418	0.412	0.407	0.402	0.397	0.387	0.379	0.371
15.5	0.423	0.417	0.411	0.406	0.401	0.391	0.382	0.374
16.0	0.428	0.422	0.416	0.410	0.405	0.395	0.386	0.377
17.0	0.437	0.431	0.425	0.419	0.413	0.402	0.393	0.384
18.0	0.446	0.439	0.433	0.427	0.421	0.409	0.399	0.389
19.0	0.455	0.448	0.441	0.434	0.428	0.416	0.405	0.395
20.0	0.463	0.456	0.448	0.441	0.434	0.422	0.410	0.400
21.0	0.471	0.463	0.455	0.448	0.441	0.428	0.416	0.405
22.0	0.479	0.470	0.462	0.454	0.447	0.433	0.421	0.409
23.0	0.486	0.477	0.469	0.461	0.453	0.439	0.426	0.414
24.0	0.493	0.484	0.475	0.467	0.459	0.444	0.430	0.418
25.0	0.500	0.490	0.481	0.472	0.464	0.449	0.435	0.422
26.0	0.507	0.496	0.487	0.478	0.469	0.453	0.439	0.426
27.0	0.513	0.502	0.492	0.483	0.474	0.458	0.443	0.429
28.0	0.519	0.508	0.498	0.488	0.479	0.462	0.447	0.433
29.0	0.525	0.514	0.503	0.493	0.484	0.466	0.450	0.436
30.0	0.531	0.519	0.508	0.498	0.488	0.470	0.454	0.439

TABLE 95 AREAS OF GIVEN NUMBERS OF BARS IN cm<sup>2</sup>

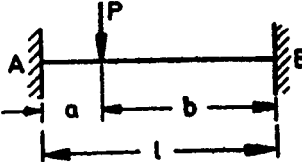
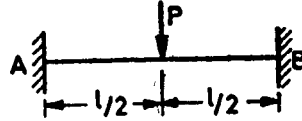
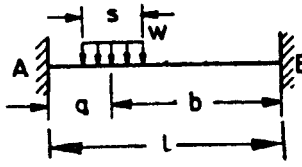
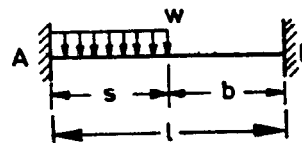
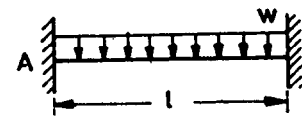
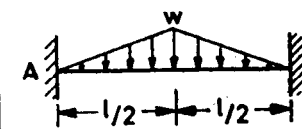
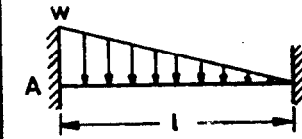
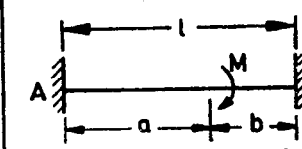
NUMBER OF BARS	BAR DIAMETER, mm												
	6	8	10	12	14	16	18	20	22	25	28	32	36
1	0.28	0.50	0.79	1.13	1.54	2.01	2.54	3.14	3.80	4.91	6.16	8.04	10.18
2	0.56	1.00	1.57	2.26	3.07	4.02	5.08	6.28	7.60	9.81	12.31	16.08	20.35
3	0.84	1.50	2.35	3.39	4.61	6.03	7.63	9.42	11.40	14.72	18.47	24.12	30.53
4	1.13	2.01	3.14	4.52	6.15	8.04	10.17	12.56	15.20	19.63	24.63	32.17	40.71
5	1.41	2.51	3.92	5.65	7.69	10.05	12.72	15.70	19.00	24.54	30.78	40.21	50.89
6	1.69	3.01	4.71	6.78	9.23	12.06	15.26	18.85	22.80	29.45	36.94	48.25	61.07
7	1.97	3.51	5.49	7.91	10.77	14.07	17.81	21.99	26.60	34.36	43.10	56.29	71.25
8	2.26	4.02	6.28	9.04	12.31	16.08	20.35	25.13	30.41	39.27	49.26	64.34	81.43
9	2.54	4.52	7.06	10.17	13.85	18.09	22.90	28.27	34.21	44.17	55.41	72.38	91.60
10	2.82	5.02	7.85	11.31	15.39	20.10	25.44	31.41	38.01	49.08	61.57	80.42	101.78
11	3.11	5.52	8.63	12.44	16.93	22.11	27.99	34.55	41.81	53.99	67.73	88.46	111.96
12	3.39	6.03	9.42	13.57	18.47	24.12	30.53	37.69	45.61	58.90	73.89	96.51	122.14
13	3.67	6.53	10.21	14.70	20.01	26.13	33.08	40.84	49.41	63.81	80.04	104.55	132.32
14	3.95	7.03	10.99	15.83	21.55	28.14	35.62	43.98	53.21	68.72	86.20	112.59	142.50
15	4.24	7.54	11.78	16.96	23.09	30.15	38.17	47.12	57.02	73.63	92.36	120.63	152.68
16	4.52	8.04	12.56	18.09	24.63	32.17	40.71	50.26	60.82	78.54	98.52	128.68	162.86
17	4.80	8.54	13.35	19.22	26.17	34.18	43.26	53.40	64.62	83.44	104.67	136.72	173.03
18	5.08	9.04	14.13	20.35	27.70	36.19	45.80	56.54	68.42	88.35	110.83	144.76	183.21
19	5.37	9.55	14.92	21.48	29.24	38.20	48.34	59.69	72.22	93.26	116.99	152.80	193.39
20	5.65	10.05	15.70	22.62	30.78	40.21	50.89	62.83	76.02	98.17	123.15	160.85	203.57

TABLE 96 AREAS OF BARS AT GIVEN SPACINGS

Values in cm<sup>2</sup> per Meter Width

SPACING cm	BAR DIAMETER, mm											
	6	8	10	12	14	16	18	20	22	25	28	32
5	5.65	10.05	15.71	22.62	30.79	40.21	50.89	62.83	76.03	98.17	123.15	160.85
6	4.71	8.38	13.09	18.85	25.66	33.51	42.41	52.36	63.36	81.81	102.68	34.04
7	4.04	7.18	11.22	16.16	21.99	28.72	36.35	44.88	54.30	70.12	87.96	14.89
8	3.53	6.28	9.82	14.14	19.24	25.13	31.81	39.27	47.52	61.36	76.9	100.53
9	3.14	5.58	8.73	12.57	17.10	22.34	28.27	34.91	42.24	54.54	68.42	89.36
10	2.83	5.03	7.85	11.31	15.39	20.11	25.45	31.42	38.01	49.09	61.57	80.42
11	2.57	4.57	7.14	10.28	13.99	18.28	23.13	28.56	34.56	44.62	55.98	73.11
12	2.36	4.19	6.54	9.42	12.83	16.75	21.21	26.18	31.68	40.91	51.31	67.02
13	2.17	3.87	6.04	8.70	11.84	15.47	19.57	24.17	29.24	37.76	47.37	61.86
14	2.02	3.59	5.61	8.08	11.00	14.36	18.18	22.44	27.15	35.06	43.98	57.45
15	1.88	3.35	5.24	7.54	10.26	13.40	16.96	20.94	25.34	32.72	41.05	53.62
16	1.77	3.14	4.91	7.07	9.62	12.57	15.90	19.63	23.76	30.68	38.48	50.27
17	1.66	2.96	4.62	6.65	9.05	11.83	14.97	18.48	22.36	28.87	36.22	47.31
18	1.57	2.79	4.36	6.28	8.55	11.17	14.44	17.45	21.12	27.27	24.21	44.68
19	1.49	2.65	4.13	5.95	8.10	10.58	13.39	16.53	20.01	25.84	32.41	42.33
20	1.41	2.51	3.93	5.65	7.70	10.05	12.72	15.71	19.01	24.54	30.79	40.21
21	1.35	2.39	3.74	5.39	7.33	9.57	12.12	14.96	18.10	23.37	29.32	38.30
22	1.28	2.28	3.57	5.14	7.00	9.14	11.57	4.28	17.28	22.31	27.99	36.56
23	1.23	2.18	3.41	4.92	6.69	8.74	11.06	13.66	16.53	21.34	26.77	34.97
24	1.18	2.09	3.27	4.71	6.41	8.38	10.60	13.09	15.84	20.54	25.66	33.51
25	1.13	2.01	3.14	4.52	6.16	8.04	10.18	12.57	15.20	19.63	24.63	32.17
26	1.09	1.93	3.02	4.35	5.92	7.73	9.79	12.08	14.62	18.88	23.68	30.93
27	1.05	1.86	2.91	4.19	5.70	7.45	9.42	11.64	14.08	18.18	22.81	29.79
28	1.01	1.79	2.80	4.04	5.50	7.18	9.09	11.22	13.58	17.53	21.99	28.76
29	0.97	1.73	2.71	3.90	5.31	6.93	8.77	10.83	13.11	16.93	21.23	27.73
30	0.94	1.68	2.62	3.77	5.13	6.70	8.48	10.47	12.67	16.36	20.52	26.81
32	0.88	1.57	2.45	3.53	4.81	6.28	7.95	9.82	11.88	15.34	19.24	25.13
34	0.83	1.48	2.31	3.33	4.53	5.91	7.48	9.24	11.18	14.44	18.11	23.65
36	0.78	1.40	2.18	3.14	4.28	5.58	7.07	8.73	10.56	13.63	17.10	22.34
38	0.74	1.32	2.07	2.98	4.05	5.29	6.70	8.27	10.00	12.92	16.20	21.16
40	0.71	1.26	1.96	2.83	3.85	5.03	6.36	7.85	9.50	12.27	15.39	20.11

Table 97 FIXED END MOMENTS FOR PRISMATIC BEAMS

LOAD TYPE	$M_{FA}$	$M_{FB}$
	$+\frac{Pab^2}{l^2}$	$-\frac{Pa^2b}{l^2}$
	$+\frac{Pl}{8}$	$-\frac{Pl}{8}$
	$+\frac{ws}{12l^2} [12ab^2 + s^2(l-3b)]$	$-\frac{ws}{12l^2} [12a^2b + s^2(l-3a)]$
	$+\frac{ws^2}{12l^2} [2l(3l-4s) + 3s^2]$	$-\frac{ws^3}{12l^2} (4l-3s)$
	$+\frac{wl^2}{12}$	$-\frac{wl^2}{12}$
	$+\frac{5wl^2}{96}$	$-\frac{5wl^2}{96}$
	$+\frac{wl^2}{20}$	$-\frac{wl^2}{30}$
	$-M\frac{b}{l}(2-\frac{3b}{l})$	$-M\frac{a}{l}(2-\frac{3a}{l})$

Note: - w is the load per unit length

Table 98 DEFLECTION FORMULAE FOR PRISMATIC BEAMS

	$\frac{5}{384} \times \frac{Wl^3}{EI}$		$\frac{Wl^3}{384 EI}$
	$\frac{Pl^3}{48 EI}$		$\frac{Pl^3}{192 EI}$
	$\frac{23 Pl^3}{648 EI}$		$\frac{5 Pl^3}{648 EI}$
	$\frac{Wl^3}{8 EI}$		$\frac{Wl^3}{185 EI}$
	$\frac{Pl^3}{3 EI}$		$\frac{1}{16} \times \frac{Ml^2}{EI}$
<p>Note:- W is total distributed load</p>			