

IS : 7942 - 1976

Indian Standard
CODE OF PRACTICE FOR
DAYLIGHTING OF EDUCATIONAL BUILDINGS

UDC 628.921/928 : 727

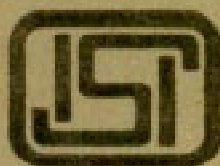

© Copyright 1976

INDIAN STANDARDS INSTITUTION
MANAK BHAVAN, 9 BAHADUR SHAH ZAFAR MARG
NEW DELHI 110002

Price ~~Rs 10.00~~

Gr 2

May 1976

Indian Standard

CODE OF PRACTICE FOR DAYLIGHTING OF EDUCATIONAL BUILDINGS

Functional Requirements in Buildings Sectional Committee, BDC 12

<i>Chairman</i>	<i>Representing</i>
LT-GEN B. N. DAS*	Ministry of Defence
<i>Members</i>	
ADDITIONAL DIRECTOR STANDARDS (ARCHITECTURE)	Ministry of Railways
JOINT DIRECTOR STANDARDS (ARCHITECTURE) (<i>Alternate</i>)	
DIRECTOR (ARCHITECTURE)	Central Public Works Department
DIRECTOR	Directorate General of Observatories, New Delhi
SHRIMATI E. S. GHUMAN	Indian Institute of Architects, Bombay
SHRI J. M. BENJAMIN (<i>Alternate</i>)	
SHRI R. G. GOKHALE	In personal capacity (<i>Nirman Bhavan, New Delhi</i>)
SHRI J. C. KAPUR	Danfoss (India) Ltd, New Delhi
SHRI B. D. KSHIRSAGAR	Ministry of Defence
SHRI L. R. LALLA (<i>Alternate</i>)	
SHRI G. C. MATHUR	National Buildings Organization, New Delhi
SHRI M. M. MISTRY (<i>Alternate</i>)	
DR V. NARASIMHAN	Central Building Research Institute (CSIR), Roorkee
SHRI M. R. SHARMA (<i>Alternate</i>)	
SHRI J. R. OVALEKAR	National Safety Council, Bombay
SHRI N. RAGHAVAN (<i>Alternate</i>)	
SHRI M. M. PANDE	Voltas Ltd, Bombay
SHRI R. N. PAWAR	Directorate General of Health Services, New Delhi
SHRI S. PURUSHOTHAMA	Ministry of Labour, Employment & Rehabilitation, New Delhi
PROF RATTAN KUMAR	University of Roorkee
SHRI S. SUBBA RAO	All India Institute of Hygiene & Public Health, Calcutta
SHRI A. V. RAO (<i>Alternate</i>)	

(Continued on page 2)

*Also represents The Institution of Engineers (India).

© Copyright 1976

INDIAN STANDARDS INSTITUTION

This publication is protected under the *Indian Copyright Act (XIV of 1957)* and reproduction in whole or in part by any means except with written permission of the publisher shall be deemed to be an infringement of copyright under the said Act.

IS : 7942 - 1976

(Continued from page 1)

Members

SHRI SAYED S. SHAFI
SHRI D. P. SHARMA (*Alternate*)
SHRI R. L. SURI
SHRI D. AJITHA SIMHA,
Director (Civ Engg)

Representing

Institute of Town Planners, New Delhi
Suri & Suri Consulting Acoustical Engineers,
New Delhi
Director General, ISI (*Ex-officio Member*)

Secretary

SHRI V. KALYANASUNDARAM
Assistant Director (Civ Engg), ISI

Daylight Standards Subcommittee, BDC 12 : 3

Convener

DR V. NARASIMHAN

Central Building Research Institute (CSIR),
Roorkee

Members

DR B. K. SAXENA (*Alternate to*
DR V. NARASIMHAN)
SHRI J. C. BHATTACHARYA
DR S. R. DAS
DR V. D. P. SASTRY (*Alternate*)
JOINT DIRECTOR STANDARDS
(ARCHITECTURE)
SHRI M. M. MISTRY
SHRI R. L. CHOPRA (*Alternate*)
SHRI R. N. PAWAR
SUPERINTENDING ENGINEER

Directorate General of Observatories, New Delhi
National Physical Laboratory (CSIR), New Delhi
Ministry of Railways
National Buildings Organization, New Delhi
Directorate General of Health Services, New Delhi
Central Public Works Department

Indian Standard

CODE OF PRACTICE FOR DAYLIGHTING OF EDUCATIONAL BUILDINGS

0. FOREWORD

0.1 This Indian Standard was adopted by the Indian Standards Institution on 28 January 1976, after the draft finalized by the Functional Requirements in Buildings Sectional Committee had been approved by the Civil Engineering Division Council.

0.2 Good lighting is an essential ingredient of a successful educational building. A careful and informed approach to lighting design is particularly important in schools for they contain a very wide range of activities embracing a complex array of different visual tasks. It is desirable to provide good lighting conditions for children and young people during their school hours, so that they may develop the habit of using their eyes intelligently and carry into later life an awareness of the value of good lighting conditions.

0.3 The human eye is sensitive to light in the direct line of sight and the field surrounding it to a cone of about 70°.

0.4 Methods of planning suggested in this standard are subjected to continuous research and changes from time to time and the designer should keep in view of the need to modify designs on the basis of new experience.

0.5 Data given in IS : 2440-1968* and IS : 3646 (Part II) 1966† will be useful in planning daylighting of educational buildings.

0.6 In formulating the code, assistance has been derived from 'Design for Daylighting' published by Central Building Research Institute, Roorkee.

1. SCOPE

1.1 This code covers the principle and practice of daylighting of educational buildings with special reference to teaching, laboratory and working areas including libraries and reading rooms.

*Guide for daylighting of buildings (*first revision*).

†Code of practice for interior illumination : Part II Schedule for values of illumination and glare index.

2. TERMINOLOGY

2.0 For the purpose of this standard the following definitions shall apply.

2.1 Altitude (θ) — The angular distance of any point on the celestial sphere, measured from the horizon, on the great circle passing through the body and the zenith.

2.2 Azimuth (ϕ) — The angle measured between the meridians passing through the north point and the point in question (point *C* in Fig. 1).

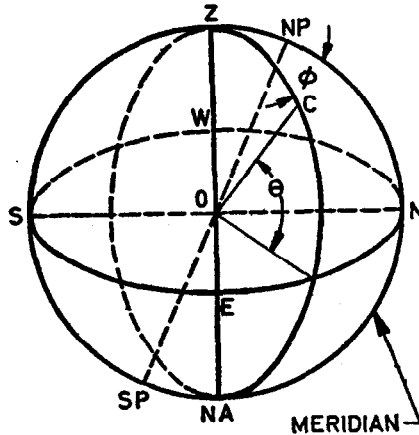

REFERENCES

O — Observer's Station
C — Celestial Body
Z — Zenith
NA — Nadir
N — Geographical North

S — Geographical South
E — Geographical East
W — Geographical West
NP — Celestial North Pole
SP — Celestial South Pole

FIG. 1 AZIMUTH OF A CELESTIAL BODY

2.3 Candela (Cd) — SI unit of luminous intensity.

Candela = 1 lumen per steradian.

2.4 Clear Design Sky — This is the clear sky corresponding to a solar altitude of 15° . The relative luminance of the sky relative to zenith opposite to the sun is constant for a given altitude up to 15° and beyond 15° it decreases as the altitude of the angle of observation increases. The corresponding exterior design illumination is taken as 8 000 lux from the entire sky vault, direct sunlight being excluded.

2.5 Colour Rendering — General expression for the colour appearance of object in comparison with their colour appearance under a reference illuminant.

2.6 Contrast — The subjective assessment of the difference in appearance of the two parts of a field of view seen simultaneously or successively hence

luminosity brightness contrast, lightness contrast, colour contrast or simultaneous contrast. Objectively it is the relative difference of luminance between two parts of the field of view.

2.7 Daylight Factor — Is a measure of the total daylight illumination at a point on a given plane expressed as a ratio (percentage) which the illumination at the point on the given plane bears to the simultaneous illumination on a horizontal plane due to the clear design sky at an external point open to the whole sky vault, direct sunlight being excluded.

The components of the daylight factor are the following :

- a) *The Sky Component* — It is the fraction of light from the portion of the sky visible from the point.
- b) *The Reflected Component* — It is the fraction of light due to reflections from interior and exterior surfaces.

2.8 Fenestration — Any opening or arrangement of openings (Normally filled with media for the controlled admission of daylight).

2.9 Glare — The discomfort or impairment of vision experienced when parts of the visual field are excessively bright in relation to the general surroundings.

2.10 Lumen (Lm) — SI unit of luminous flux. The luminous flux emitted within unit solid angle (one steradian) by a point source having uniform intensity of one candela.

2.11 Luminance [(at a Point of a Surface in a Given Direction) (Commonly Known as Brightness)] — The quotient of the luminous intensity in the given direction of an element of the surface containing the point under consideration by the orthogonally projected area of the element on a plane perpendicular to the given direction.

Unit: Candela per square metre (Cd/m²)

2.12 Lux (lx) — SI unit of illuminance : Illuminance produced by a luminous flux of 1 lumen uniformly distributed over 1 square metre.

$$1 \text{ lx} = \frac{\text{Lm}}{\text{m}^2}$$

2.13 Orientation — The position of a building with respect to compass direction.

2.14 Reflectance/Reflection factor (ρ_e or ρ_v) — Ratio of the reflected radiant or luminous flux to the incident flux.

2.15 Working Plane — The plane (real or imaginary) at which work is usually done and therefore on which illumination is specified and measured. Unless otherwise indicated it is assumed to be horizontal at a height 0.85 m. In educational buildings it may vary from 0.60 to 0.90 m depending on the age of students and type of task carried out.

3. VISUAL TASKS IN EDUCATION

3.1 Generally, tasks in the educative process can be either close up focus tasks like reading, writing, painting or sewing or distant focus ones like chalk board reading, seeing models, displays or distant objects. There are variations even in close up tasks since the types, papers, pencils and inks all vary, in quality, texture and reflectance.

3.2 The visibility of a task or object depends on its size, its contrast with its background and its detail. All these factors are interrelated. Visibility is improved when the contrast with the background is increased to a maximum.

4. STANDARDS OF ILLUMINATION (ILLUMINANCE)

4.1 The illumination (illuminance) of a task should be adequate both in the quantity as well as in the quality. The quantity of illumination (illuminance) is the amount of light incident on the task while quality takes into consideration factors, such as glare and colour.

4.2 The various types of task normally encountered in educational processes and the amount of illumination (illuminance) required for their satisfactory performance are listed in Table 1.

4.2.1 The levels of lighting recommended in Table 1 are those to be made available on the working plane as well as walls and chalk boards where students vision is directed.

TABLE 1 RECOMMENDED ILLUMINATION LEVELS ON WORK AREAS FOR EDUCATIONAL BUILDINGS

Sl. No.	VISUAL TASK	SUGGESTED ILLUMINATION LEVEL (lux)	CORRESPONDING DAYLIGHT FACTOR
(1)	(2)	(3)	(4)
i)	Class-room desk top chalk boards	150-300	1.9-3.8
ii)	Laboratories	200-300	2.5-3.8
iii)	Library-reading tables	150-300	1.9-3.8
iv)	Drawing, typing, sewing	300	3.8
v)	Toilets	150	1.9
vi)	Manual training	150	1.9
vii)	Children with defective vision	(Special lighting to be provided)	

NOTE --- The levels suggested in this table do not take into account the decrease in illumination due to occupancy (and the variations in the reflectances of school uniforms) and should be used as a guide only. However, in the first instance, these reductions can be treated as negligible.

5. FACTORS TO BE CONSIDERED IN SCHOOL LIGHTING

5.1 Teaching spaces in schools cater to the needs of a wide spectrum of students involving several age groups. The eye of children in the lowest age groups is in its formative stage when schooling begins. Since vision is aided by memory and memory relates to objects once seen, it follows, that in order to identify objects for the first time a higher level of lighting is required. This is true especially in the low grade schools.

5.2 Since daylighting is provided through side windows the orientation of the windows in respect of the cardinal directions has to be considered since the percolation of sunlight may not be desirable in all cases.

5.2.1 In India, especially in latitudes less than 23°N such incursion is inevitable for any orientation and suitable overhangs for east, south and west oriented apertures will have to be provided.

5.3 There is also an increase in internal daylight from design time to noon (there is a decrease thereafter) which tends to make interiors brighten up considerably. The extent of such increase can be ascertained from Fig. 2. This figure does not include the excess due to direct and externally reflected sunlight entering the room.

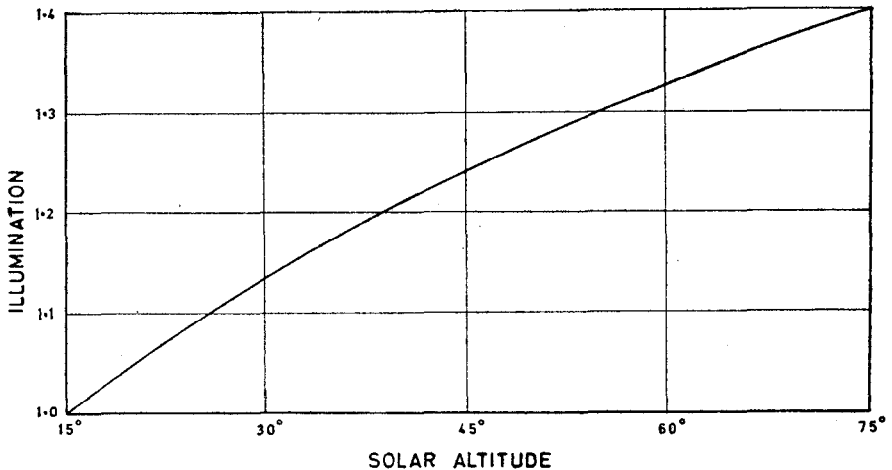

FIG. 2 CURVE SHOWING THE INCREASE IN INTERIOR DAYLIGHTING OVER DESIGN VALUE (15° SOLAR ALTITUDE REFERS TO THE DESIGN TIME AND A DESIGN ILLUMINATION OF 1.0)

5.4 The common practice in school buildings is to have a corridor for movement. Windows located on walls of the corridor are least useful as

daylighting apertures and should not be considered for daylighting. Only windows on an external wall are really useful.

5.5 Unilateral lighting from a row of windows on one wall tend to produce undesirable variations of brightness on any internal area and wherever practicable windows on opposite or adjacent walls should be provided.

5.6 Tall windows allow daylight to reach rear portions of the room, whereas wide windows of the same area ensure a spread of daylight parallel to the window but to a reduced depth within the room. Sill height of windows play a significant part in the proper balance of daylight on walls and table tops. The most effective distribution occurs when the sill height is between 0.90 and 1.05 m for a ceiling located between 3 and 3.5 m.

6. GENERAL INSTRUCTIONS

6.1 Chalk Boards and Display Charts

6.1.1 The chalk boards should be painted matt black or pale green. In the former case the reflection factor in use should be of the order of 15 percent and in the latter around 25-30 percent.

6.1.2 The location of the chalk boards should be on the walls adjacent to the window wall and placed such that the mid vertical line of the board lies between one half and two-thirds the depth of the room. This is to ensure that the glare due to windows at students' seat area is minimized. The height of the lower edge of the board should be well within the line of sight of the pupils sitting in front.

6.1.3 The minimum student seating distance from the chalk board should be not less than 2.50 m.

6.1.4 Display charts should have a matt surface and the contrast between the letters and background as well as size of letters adequate to ensure easy readability from any point in the class room.

6.2 Laboratory Work Benches

6.2.1 The orientations of work benches in relation to window walls depend on the type of work done. Where high levels of daylight are required, as for instance, in microscope work these tables should be along the window wall with the students facing the windows.

6.2.2 In other laboratory work, orientation of tables perpendicular to the window wall and located between adjacent windows is recommended.

6.3 Student Seating in Relation to Glare from Windows

6.3.1 While no hard and fast rules can be laid down it is suggested that the angle between the sight from the student to the farthest window edge and the normal to the desk length is within 50°. While individual desks can be oriented to meet this requirements it may not be possible to ensure this stipulation where more than two students occupy a bench.

6.4 Internal Wall Finish — From considerations of inter-reflections from internal and external surfaces it is desirable to have the ceiling white washed, walls off-white and floor terrazzo finished. The reflection factors of ceiling, walls and floor surfaces should then lie in the range 0.80-0.70, 0.7-0.5 and 0.35-0.25 respectively. Walls may be tinted in any shade of colour consistent with aesthetic requirements but within the specified reflection factors.

6.5 Window Glazing

6.5.1 Window glasses have a tendency to collect dirt and hence a periodic cleaning schedule has to be stipulated, particularly for the winter months when the collection of dirt on glass reaches such high proportions that the transmission of light through the glass reaches very low values.

6.5.2 Use of plastics in place of glass should be done with caution since many plastics will suffer a loss of light transmittance with age.

6.5.3 The tendency to combine glazing with wire mesh on the same leaf (to ensure safety with economy) is not recommended in view of the difficulty in cleaning the glass surface adjacent to the mesh.

6.6 External Obstructions

6.6.1 In the planning for daylighting external obstructions play a vital role in reducing the amount of daylight. Rows of trees parallel to window wall are more obstructive than those normal to it at the same distance. A 6.0 m tall row of trees in front of a window at 6.0 m away may reduce the daylight factor by a half compared to a similar row of trees 15 m away when the reduction will be only about 10 percent (*see 7.2.6*).

6.6.2 The complexity of external obstruction and their influence on interior daylight makes it difficult to generalize the recommendations and every care will have to be dealt with on its merits.

7. WINDOW DESIGN

7.1 Clauses 7.1.1 to 7.2.6.5 give a simplified method of arriving at the window dimensions to provide a given daylight factor on the working plane in rooms whose floor area is less than 60 sq m and the proportions of the rectangular rooms with side lengths in the ratio of 2 : 3.

7.1.1 Since the location of the window(s) on the shorter or longer wall influence the availability of daylight at the centre of the room or the rear thereof, this factor has to be taken into consideration.

7.1.2 The relation between daylight factor at the centre of a room (or the rear of it, that is near the rear wall) and window area expressed as a percentage of floor area that will provide the daylight factor is shown in Fig. 3 and Fig. 4 for four possible situations, namely: (a) the aperture is just an opening in the wall, (b) the opening is glazed with 3 mm thick glass, (c) the glazed opening is a wooden window, and (d) the glazed opening is a

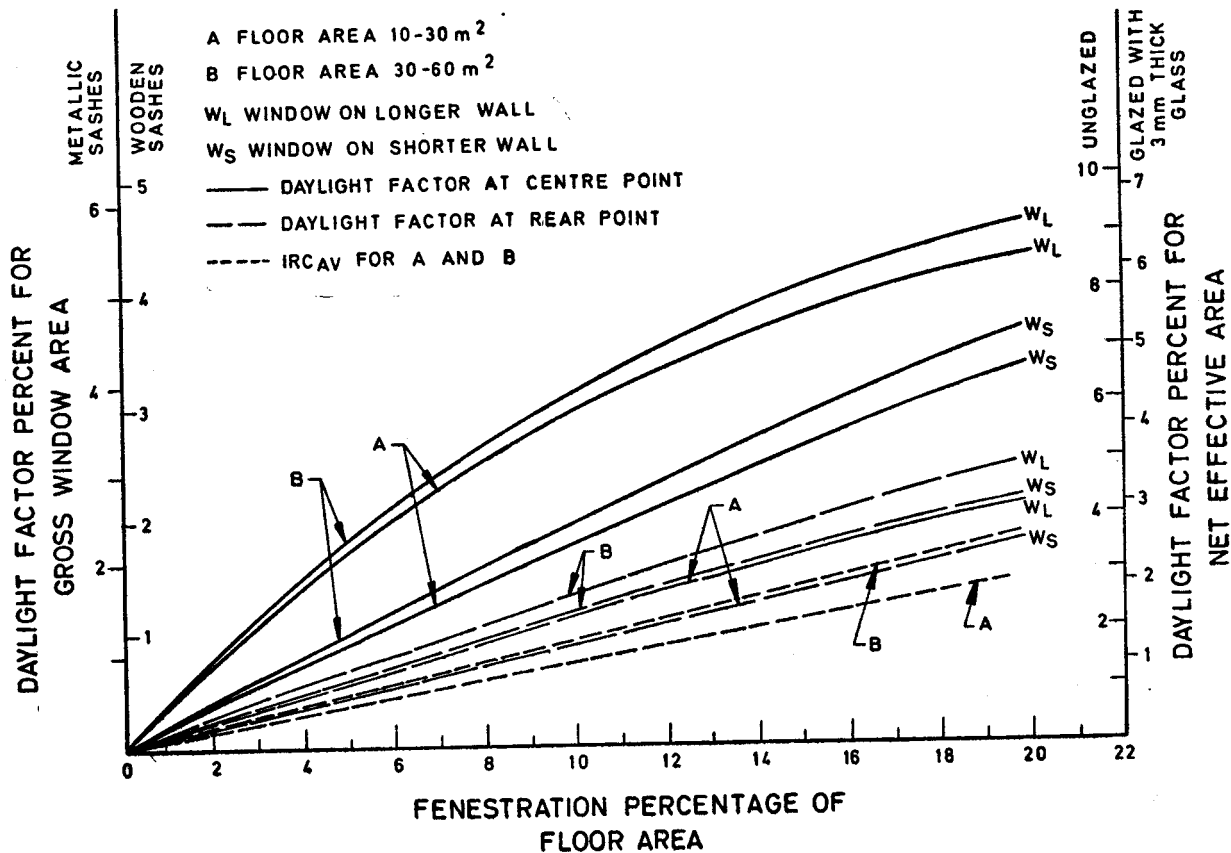

FIG. 3 DAYLIGHT FACTORS ON THE WORKING PLANE FOR A CENTRALLY LOCATED WINDOW

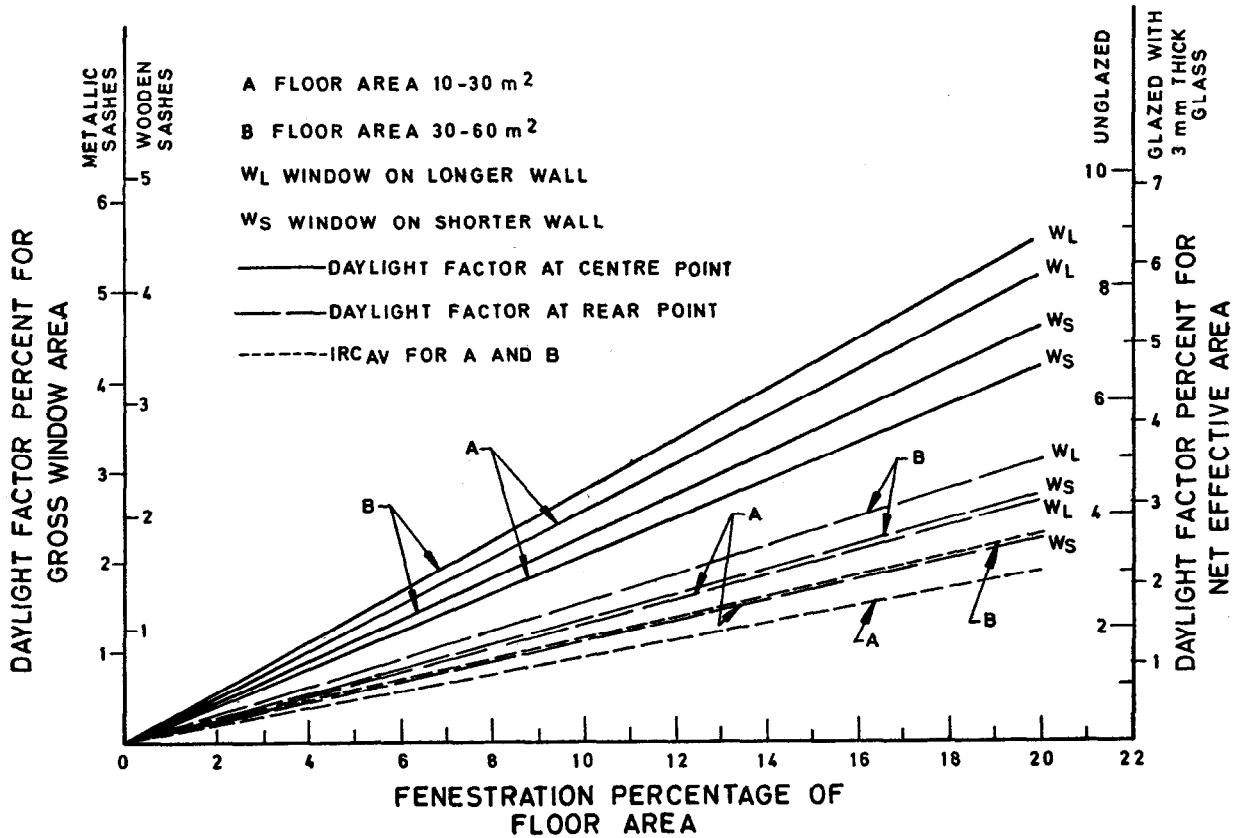

FIG. 4 DAYLIGHT FACTOR ON THE WORKING PLANE FOR A CORNER LOCATED WINDOW

metal window (it is to be noted that a wooden window frame cuts off more daylight as compared to metallic window frame). The abscissae are marked accordingly.

7.1.3 The effect of unobstructed windows on long or short wall on the daylight availability at the centre of a room or its rear can be ascertained from Fig. 3 and Fig. 4. In arriving at the results given in Fig. 3 and Fig. 4 the following assumptions were made:

- a) Interior of the room possesses the following reflection factors;
 - 1) Walls : 45-50 percent,
 - 2) Ceiling : 70-75 percent, and
 - 3) Floor : 25-30 percent.
- b) Ceiling height is taken to be 2.75 m;
- c) Windows are provided with louvers to cut the incursion of sunlight;
- d) Combined thickness of wall and width of louver is taken to be 60 cm;
- e) Ground reflection factor is taken as 0.25; and
- f) No external obstruction.

7.1.4 The fenestration percentage of floor area arrived at by using Fig. 3, Fig. 4 and Table I is expected to provide the required amount of daylight at the point in question. However, the presence of dirt on glass reduces the quantity of light entering the room and the glazing has to be cleaned periodically. The area of the window arrived at may be split into two or three and located on the window wall provide uniformly distributed daylighting on the working planes. The sill height should be between 75 to 105 cm to get the maximum advantage of vertical and horizontal plane illumination. The need to provide suitable louvers or overhangs to avoid direct sunshine should be considered.

7.2 Lux Grid Method — The lux grid method may be used within 10 percent accuracy to

- a) assess the illumination level on the working plane or other horizontal surfaces as provided by a given arrangement of windows, and
- b) calculate window sizes to give desired illumination levels on the working places.

7.2.1 The grid (Fig. 5 and 6) represent the window wall of a room above the working plane. The window wall is divided into small squares and each square contains a few dots and a few crosses. The system is symmetrical about the vertical line PY passing through the point P . The horizontal PW through P corresponds to the plane of reference, usually the working plane. By drawing the elevation of the window on the grid and counting the number of dots and crosses within the window outline, the illumination can be found. If the desired illumination is known, the size of the windows, can also be determined.

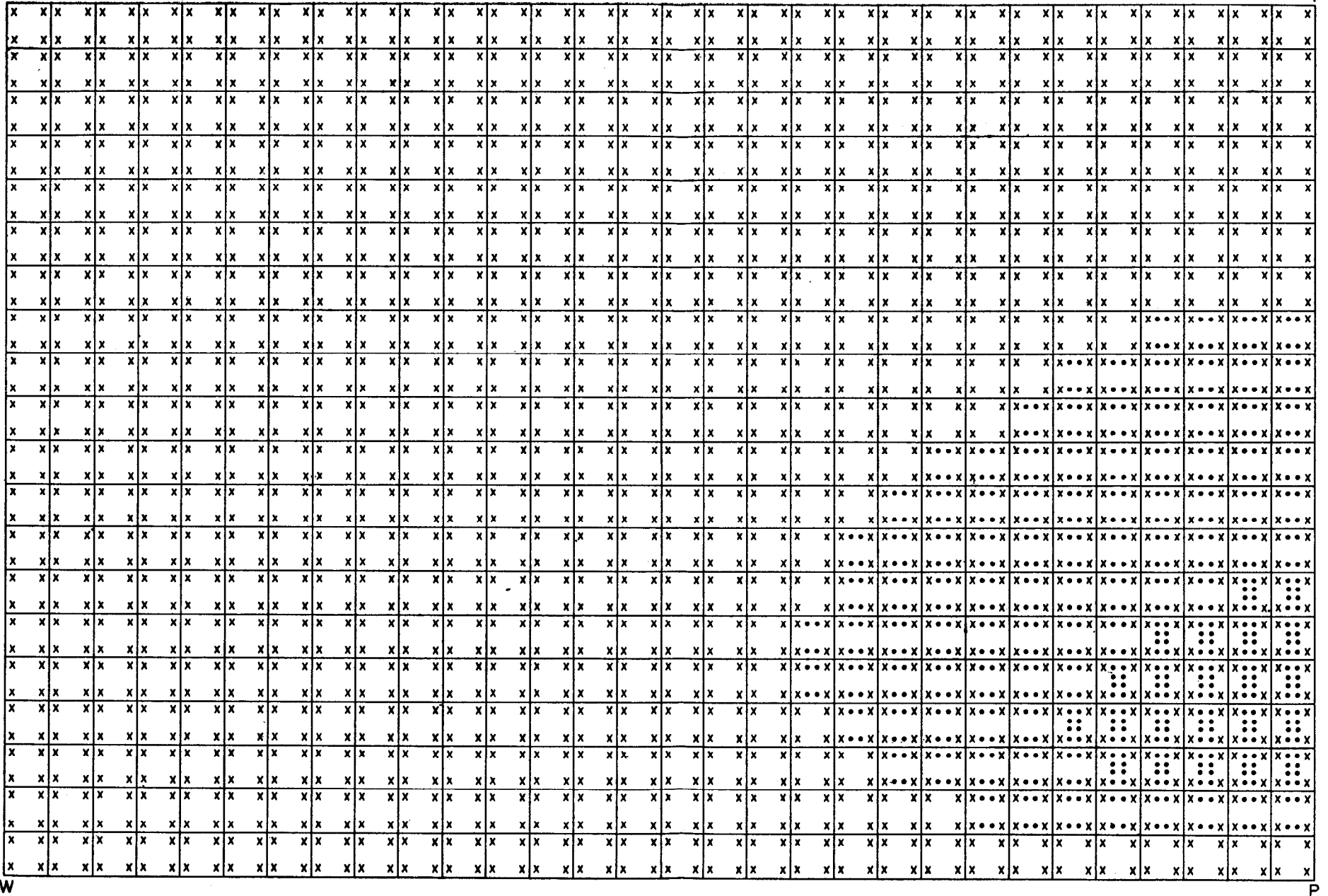

FIG. 5 LUX-GRID I FOR DAYLIGHTING DESIGN OF SIDE-LIT WINDOWS IN ABSENCE OF EXTERNAL OBSTRUCTIONS

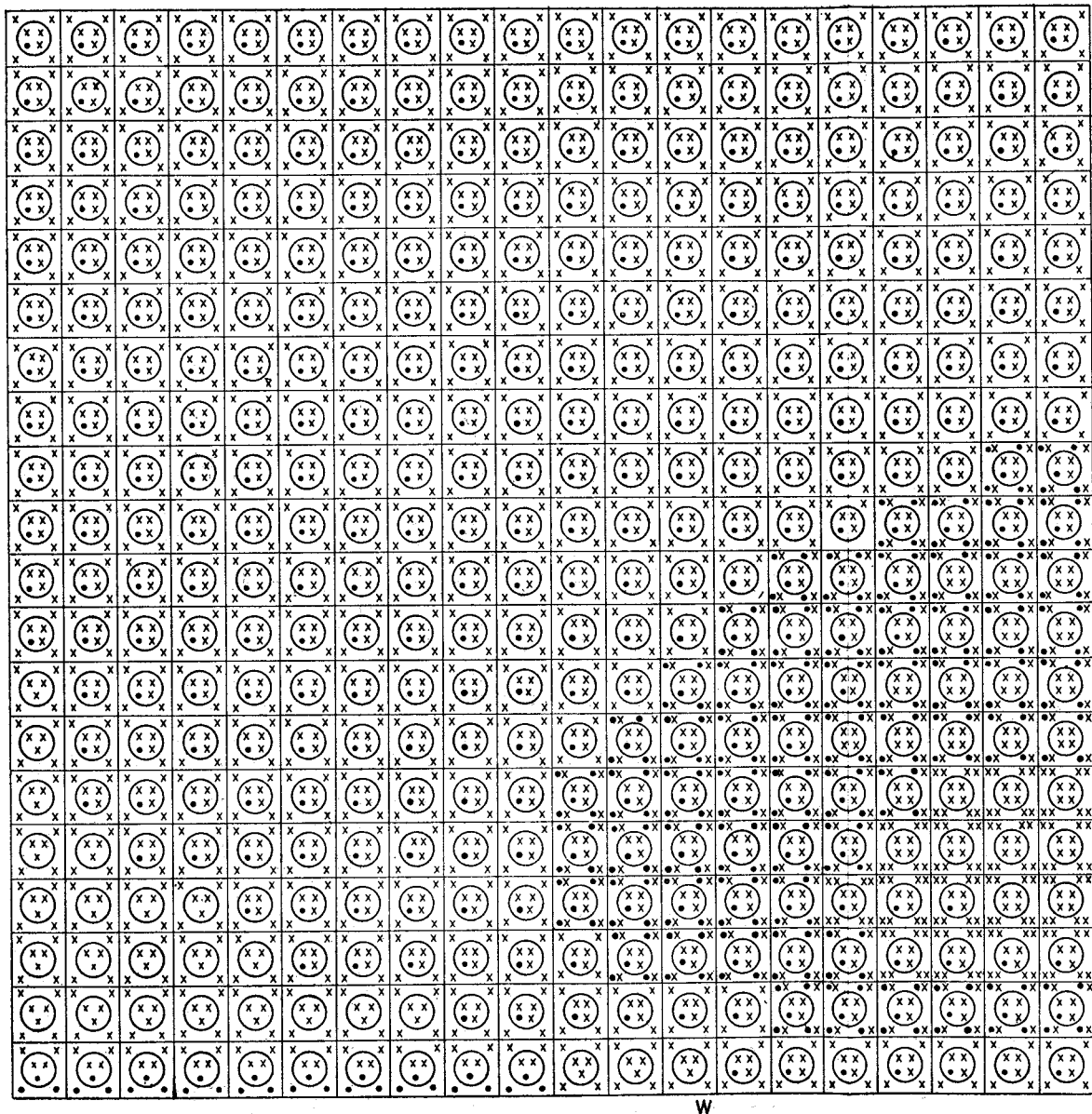

FIG. 6 LUX-GRID II FOR DAYLIGHTING DESIGN OF WINDOWS IN PRESENCE OF EXTERNAL OBSTRUCTIONS

7.2.2 The grid is based on measurements of sky luminance and daylight availability all over India and incorporated in IS : 2440-1968*.

7.2.3 Size of Grid— The squares on the grid have a scale dimension relative to the distance of a particular point on the working plane (where illumination is to be found) from the window wall measured normally from the plane of the glazing. Unit distance on the grid is one-tenth the distance between the point on the working plane and window plane. For example, if the point on the working plane is located 375 cm from the window wall, each side of the small grid is 37.5 cm.

7.2.4 Sill-Height of Window— Since illumination on the horizontal working plane comes mostly from that part of the window which is above its level, the sill of the window should be arranged either at or above the working plane height. Where due to special purposes, the sill is below the level of working plane only the dots and crosses above the working plane level will contribute to the daylight significantly.

7.2.5 Lux-Grid I for Use With Negligible External Obstructions— Figure 5 shows lux-grid to be used for determining the illumination when obstruction outside the windows are at a distance more than three times their own height from the window.

7.2.5.1 Dots and crosses— In Fig. 5, one dot has a value of 0.5 lux and one cross has a value of 2.0 lux.

7.2.5.2 Correction factor for interior finish— Illumination level calculated using lux-grid I, shall be corrected for interior finishes of the room (and of different reflectance) using figures in Table 2.

7.2.5.3 Limitations of the method (see also 7.2.5) :

- a) It is assumed that the ground outside the window has a reflection factor of 0.25 that is, grass with some brick or concrete paving.
- b) The ceiling is 2.75 m above the floor level, at the supports pitched or flat.
- c) It is assumed that the window has a 60 cm box type louver around or a 60 cm horizontal louver. It is supposed to be glazed.

When a verandah or overhang obstructs the window, the portion of the window obscured from the point of observation as seen projected on the window plane should be treated as not contributing to the daylighting of the point in question.

7.2.5.4 Illustrative example— An worked example has been given in Appendix A (see also 7.2.6.5) to explain the use of the method.

NOTE— The example in Appendix A deals with determination of total illumination due to two windows with external obstructions, wherein both Lux-grid I and II have been involved.

*Guide for daylighting of buildings (first revision).

7.2.6 Lux-grid II for Use in Presence of External Obstructions — Figure 6 shows lux-grid to be used for determining the illumination when obstruction (having reflection factor lying between 0.4 and 0.6) outside the windows are at a distance three times or less their own height from the window.

7.2.6.1 Circle, dots and crosses — In Fig. 6 (Lux-grid II) in addition to dots and crosses inside each grid, a circle enclosing a few dots and crosses is present. The dots and crosses within the circle correspond to the daylight contributed by obstructions, while those outside the circle represent the contribution due to the unobstructed window including all external reflections. One dot has a value of 0.5 lux, one cross outside the circle has a value of 2.0 lux and one cross inside the circle has a value of 1.0 lux.

7.2.6.2 Correction factor for interior finish — Illumination levels calculated using lux-grid II, shall be corrected for interior finishes of the room (and of different reflectance) using figures in Table 3.

7.2.6.3 To estimate the available daylight at a point, the outline of the window and the obstruction are projected on the lux-grid using proper scales corresponding to the distances of window and obstruction from the point in question (see 7.2.3).

7.2.6.4 Depending on the height H and distance D of the obstruction from the point and window wall respectively, four cases arise :

a) $D > 3H$: This case can be dealt as unobstructed as far as daylighting is concerned and lux-grid I (see 7.2.3) shall be used.

b) $1.5 H < D \leq 3 H$:

First Step — The contribution due to unobstructed portion of the window using lux-grid I (see 7.2.5) and lux-grid II should be found out and the mean value taken.

Second Step — The contribution due to the obstructed portion by counting the dots and crosses within the enclosed circle (in the obstructed part) should be found out using lux-grid II and the value so obtained be multiplied by a factor 1.8.

Third Step — The values obtained in the above two steps should be added.

c) $0.5 H < D \leq 1.5 H$:

The contributions of the unobstructed and obstructed portions of the window should be found out using lux-grid II separately and the values be added.

d) $D \leq 0.5 H$:

First Step — The daylight due to unobstructed part should be found out using lux-grid II.

Second Step — The daylight due to obstructed part should be found out using lux-grid II and the value so obtained be reduced by 50 per cent.

Third Step — The values obtained in the above two steps should be added.

TABLE 2 CORRECTION FACTORS PER SQUARE ($a \times a$)-LUX

(Clause 7.2.5.2)

DISTANCE OF POINT FROM THE WINDOW, d (1)	SIDE OF ONE SQUARE IN THE GRID, a (2)	FLOOR AREA WITHIN 10-25 m ²			FLOOR AREA WITHIN 25-50 m ²			FLOOR AREA WITHIN 50-100 m ²		
		A^1	B^2	C^3	A^1	B^2	C^3	A^1	B^2	C^3
		(3)	(4)	(5)	(6)	(7)	(8)	(9)	(10)	(11)
cm	cm									
900	90	+26.6	+18.0	+9.5	+9.5	+5.2	+1.0	+1.0	-1.2	-3.3
840	84	+22.2	+14.7	+7.3	+7.3	+3.6	0	0	-2.0	-3.9
780	78	+18.0	+11.7	+5.2	+5.2	+2.0	-1.2	-1.2	-2.8	-4.4
720	72	+14.3	+8.8	+3.3	+3.3	0	-2.1	-2.1	-3.5	-4.9
660	66	+10.8	+6.2	+1.6	+1.6	-0.7	-3.0	-3.0	-4.2	-5.3
600	60	+7.6	+3.8	0	0	-1.9	-3.8	-3.8	-4.8	-5.7
540	54	+4.7	+1.6	-1.4	-1.4	-3.0	-4.5	-4.5	-5.3	-6.1
480	48	+2.1	0	-2.7	-2.7	-4.0	-5.2	-5.2	-5.8	-6.4
420	42	0	-2.0	-3.9	-3.9	-4.8	-5.7	-5.7	-6.2	-6.7
360	36	-2.1	-3.5	-4.9	-4.9	-5.5	-6.2	-6.2	-6.6	-6.9
300	30	-3.8	-4.8	-5.7	-5.7	-6.2	-6.7	-6.7	-6.9	-7.1
240	24	-5.2	-5.8	-6.4	-6.4	-6.7	-7.0	-7.0	-7.1	-7.3
180	18	-6.2	-6.6	-6.9	-6.9	-7.1	-7.3	-7.3	-7.3	-7.4
120	12	-7.0	-7.1	-7.3	-7.3	-7.4	-7.4	-7.4	-7.5	-7.5

NOTE 1 — Finish A ceiling white (reflection factor = 0.7 to 0.8), walls off white (reflection factor = 0.45 to 0.55) and floor grey (reflection factor = 0.3).

NOTE 2 — Finish B ceiling off white, walls off white and floor grey.

NOTE 3 — Finish C ceiling off white, walls dark (reflection factor = 0.25 to 0.3) and floor grey.

TABLE 3 CORRECTION FACTORS PER SQUARE ($\alpha \times a$)-LUX

(Clause 7.2.6.2)

DISTANCE OF POINT FROM THE WINDOW, d (1)	SIDE OF ONE SQUARE IN THE GRID, a (2)	FLOOR AREA WITHIN 10-25 m ²			FLOOR AREA WITHIN 25-50 m ²			FLOOR AREA WITHIN 50-100 m ²		
		A ¹	B ²	C ³	A ¹	B ²	C ³	A ¹	B ²	C ³
		(3)	(4)	(5)	(6)	(7)	(8)	(9)	(10)	(11)
cm	cm									
900	90	+10.6	+7.2	+3.8	+3.8	+2.1	+0.4	+0.4	-0.5	-1.3
840	84	+ 8.9	+5.9	+2.9	+2.9	+1.4	0	0	-0.8	-1.6
780	78	+ 7.2	+4.7	+2.1	+2.1	+0.8	-0.5	-0.5	-1.1	-1.8
720	72	+ 5.7	+3.5	+1.3	+1.3	0	-0.9	-0.9	-1.4	-1.9
660	66	+ 4.3	+2.5	+0.6	+0.6	-0.3	-1.2	-1.2	-1.7	-2.1
600	60	+ 3.0	+1.5	0	0	-0.8	-1.5	-1.5	-1.9	-2.3
540	54	+ 1.9	+0.7	-0.6	-0.6	-1.2	-1.8	-1.8	-2.1	-2.4
480	48	+ 0.9	0	-1.1	-1.1	-1.6	-2.1	-2.1	-2.3	-2.6
420	42	0	-0.8	-1.6	-1.6	-1.9	-2.3	-2.3	-2.5	-2.7
360	36	- 0.9	-1.4	-1.9	-1.9	-2.2	-2.5	-2.5	-2.6	-2.8
300	30	- 1.5	-1.9	-2.3	-2.3	-2.5	-2.7	-2.7	-2.8	-2.9
240	24	- 2.1	-2.3	-2.5	-2.6	-2.7	-2.8	-2.8	-2.9	-2.9
180	18	- 2.5	-2.6	-2.8	-2.8	-2.8	-2.9	-2.9	-2.9	-3.0
120	12	- 2.8	-2.9	-2.9	-2.9	-2.9	-3.0	-3.0	-3.0	-3.0

NOTE 1 — Finish A ceiling white (reflection factor = 0.7 to 0.8), walls off white (reflection factor = 0.45 to 0.55) and floor grey (reflection factor = 0.3).

NOTE 2 — Finish B ceiling off white, walls off white and floor grey.

NOTE 3 — Finish C ceiling off white, walls dark (reflection factor = 0.25 to 0.3) and floor grey.

7.2.6.5 Illustrative example — An worked out example has been given in Appendix A to explain the use of the method.

NOTE — The example in Appendix A deals with determinations of total illumination due to two windows with external obstructions wherein methods for using both Lux-grid I and II have been involved.

APPENDIX A

(Clauses 7.2.5.4, 7.2.6.5 and Fig. 5 and 6)

ILLUSTRATIVE EXAMPLE OF DESIGN OF WINDOWS WITH EXTERNAL OBSTRUCTION

A-1. EXAMPLE

A-1.1 Consider (Fig. 7) a point P_1 at 6 m away from the window wall. Assume that the room in which the point is located has finish B, and floor area is approximately 43 m². The room has two windows each of size 2.4×1.5 m² at a sill height of 30 cm above the working plane symmetrically located with respect to point P_1 . The windows face an infinitely long parallel obstruction (reflectance 0.5) located at a distance of 18.0 m (D) from the windows and of height (H) 6.0 m above the working plane.

This corresponds to case (b) of **7.2.6.4** where $1.5 H < D \leq 3 H$

First Step — The projection of the obstruction on the lux-grid I and II are shown in Fig. 8A and 8B. The contribution due to unobstructed portion of the windows using lux-grid I (Fig. 8A) and lux-grid II (Fig. 8B) are determined as follows.

- i) Use grid I (see Fig. 8A).

The number of grid squares for unobstructed parts of window = 4.

Correction factor for interior finish B (Table 2) = -1.9 lux.

Total correction for 4 squares = $4 \times (-1.9) = -7.6$ lux.

Illumination at P_1 from Fig. 8A:

Crosses 16	= 32.0 lux
Dots 32	= 16.0 lux
Total	= 48.0 lux
Correction	= -7.6 lux
Net illumination	= 40.4 lux

- ii) Use grid II (see Fig. 8B).

The number of grid squares for unobstructed part of windows is again 4 but these include now 28 crosses and 4 dots giving total illumination at $P_1 = 28 \times 1.0 + 4 \times 0.5 = 30.0$ lux.

Correction factor per square, using Table 3, = -0.8 lux

Hence total correction $4 \times (-0.8) = -3.2$ lux.

Net illumination as given by lux-grid II = $30.0 - 3.2 = 26.8$ lux.

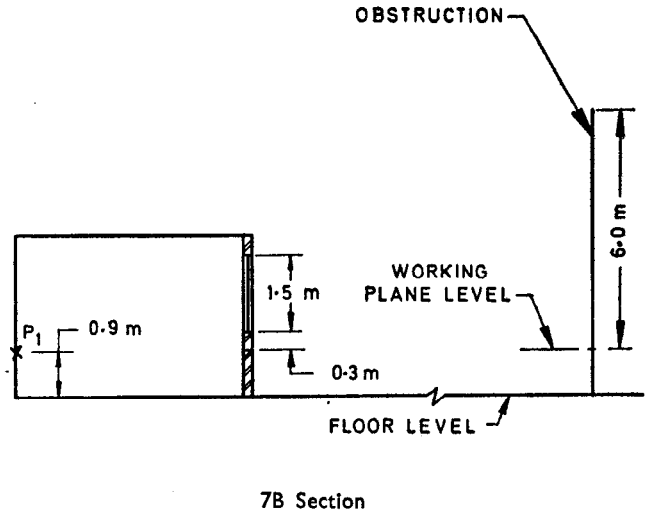
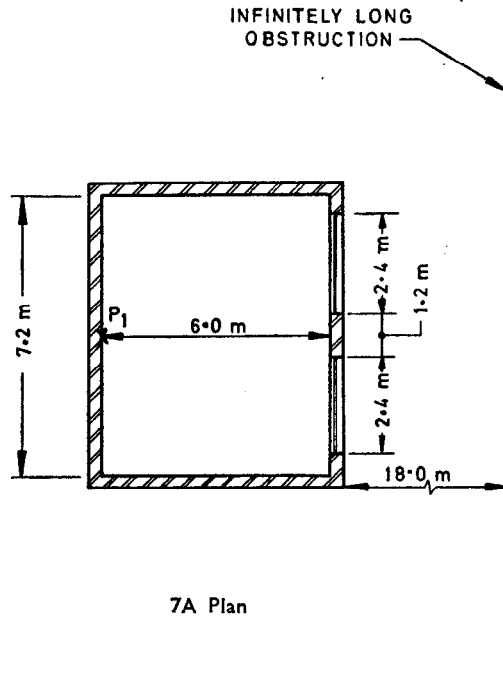

FIG. 7 TYPICAL EXAMPLE FOR WINDOW WITH EXTERNAL OBSTRUCTION

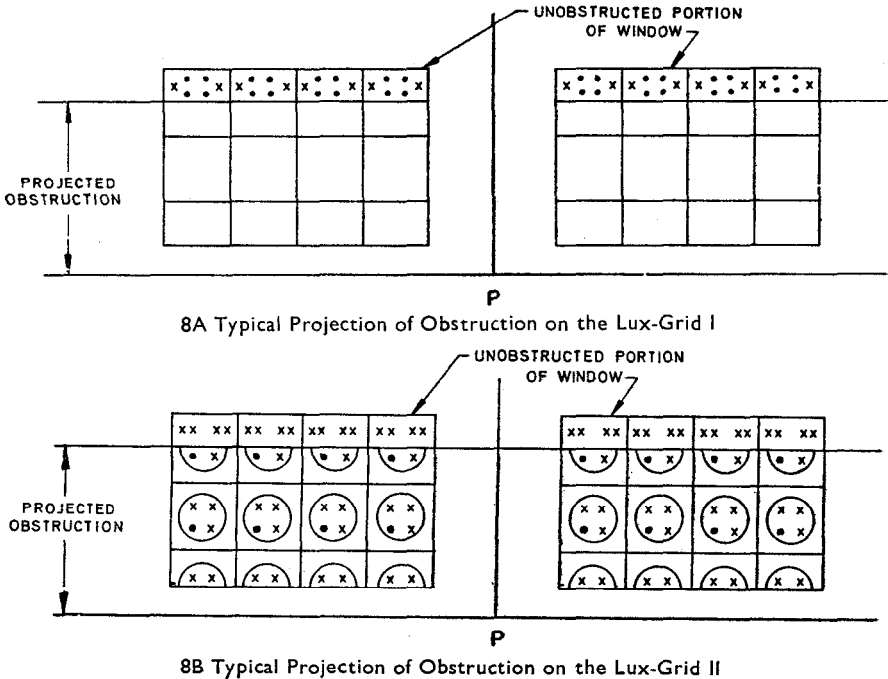

FIG. 8 TYPICAL PROJECTION OF OBSTRUCTION ON THE LUX-GRIDS I & II

The mean values obtained from grid I and II = $\frac{1}{2}(40.4 + 26.8) = 33.6$ lux, which is net illumination from the unobstructed part of the windows.

Second Step — The number of squares enclosed by the obstructed part of the windows (Fig. 8B) = 16.

Correction factor from Table 3 = -0.8 lux

Net correction = $16 \times (-0.8)$

= -12.8 lux

Total illumination at P_1 from Fig. 8B

Crosses 48

= 48.0 lux

Dots 16

= 8.0 lux

Total = 56.0 lux

Correction = -12.8 lux

Net illumination = $56.0 - 12.8 = 43.2$ lux

Net illumination due to obstructed portion of the windows = 43.2×1.8

= 77.76 lux.

Third Step — Total illumination due to both the windows = $33.6 + 77.76$
= 111.36 lux.

INDIAN STANDARDS

ON

FUNCTIONAL REQUIREMENTS IN BUILDINGS

IS:

- 1950-1962 Code of practice for sound insulation of non-industrial buildings
- 2440-1968 Code of practice for daylighting of buildings (*first revision*)
- 2526-1963 Code of practice for accoustical design of auditoriums and conference halls
- 3103-1965 Code of practice for industrial ventilation
- 3362-1965 Code of practice for natural ventilation of residential buildings
- 3483-1965 Code of practice for noise reduction in industrial buildings
- 3792-1966 Guide for heat insulation of non-industrial buildings
- 4912-1968 Safety requirements for floor and wall openings, railings and toe boards
- 4954-1968 Recommendations for noise abatement in town planning
- 4963-1968 Recommendations for buildings and facilities for the physically handicapped
- 5499-1969 Code of practice for construction of underground air-raid shelters in natural soils
- 6060-1971 Code of practice for daylighting of factory buildings
- 6074-1971 Code of functional requirements of hotels, restaurants and other food service establishments
- 7662 (Part I)-1974 Code of practice for orientation of buildings: Part I Non-industrial buildings

PUBLICATIONS OF INDIAN STANDARDS INSTITUTION

INDIAN STANDARDS

Over 8 500 Indian Standards covering various subjects have been issued so far. Of these, the standards belonging to the Civil Engineering Group fall under the following categories:

<ul style="list-style-type: none"> Aggregates, concrete Apparatus for testing cement and concrete Asbestos cement products Bricks and blocks Builder's hardware Cement Concrete design and construction Concrete testing Construction equipment Construction practices Doors and windows Drawing office practice and equipment Fire fighting equipment Fire safety Flexible floor coverings Floor finishes Fluid flow measurement Fluid flow measuring instruments Foundation engineering Functional design of buildings Furniture Gypsum products Lime, building Loading standards, structural safety Measurement and estimation of civil engineering 	<ul style="list-style-type: none"> Modular co-ordination Multipurpose river valley projects Pipes Planning, regulation and control Plaster, paint and allied finishes Plywood and allied products Poles Pozzolanas Reinforcement, concrete Roof and roof coverings Safety in construction Sieves and wire gauzes Soil engineering Stones, building Structural design Tar and bitumen Tiles Timber Timber design and construction Timber stores Wall and ceiling finish Waterproofing and damp-proofing Water supply, drainage and sanitation Water supply, sanitation and drainage fittings Wood-based materials Unclassified
---	---

OTHER PUBLICATIONS

ISI Bulletin (Published Every Month)					
Single Copy	Rs 4-00
Annual Subscription	Rs 36-00
Standards: Monthly Additions					
Single Copy	Re 0-30
Annual Subscription	Rs 3-00
Annual Reports (from 1948-49 Onwards)	Rs 2-00 to 6-00
ISI Handbook, 1975	Rs 30-00

INDIAN STANDARDS INSTITUTION

Manak Bhavan, 9 Bahadur Shah Zafar Marg, NEW DELHI 110002

Telephone : 27 01 31 (20 lines)

Telegrams : Manaksanstha

Regional Offices:

	Telephone
Western : Novelty Chambers, Grant Road	BOMBAY 400007 37 97 29
Eastern : 5 Chowringhee Approach	CALCUTTA 700072 23-08 02
Southern : C. I. T. Campus, Adyar	MADRAS 600020 41 24 42

Branch Offices:

'Pushpak', Nurmohamed Shaikh Marg, Khanpur	AHMADABAD 380001	2 03 91
'F' Block, Unity Bldg, Narasimharaja Square	BANGALORE 560002	2 76 49
Ahimsa Bldg, SCO 82-83, Sector 17C	CHANDIGARH 160017	2 83 20
5-8-56/57 Nampally Station Road	HYDERABAD 500001	4 57 11
117/418 B Sarvodaya Nagar	KANPUR 208005	82 72
B.C.I. Bldg, 3rd Floor, Gandhi Maidan East	PATNA 800004	5 36 55
Hantex Bldg, 2nd Floor, Rly Station Road	TRIVANDRUM 695001	32 27