

IS : 2911 ( Part III ) - 1980

*Indian Standard*  
CODE OF PRACTICE FOR  
DESIGN AND CONSTRUCTION OF PILE  
FOUNDATIONS  
PART III UNDER-REAMED PILES  
*(First Revision)*

---

Fifth Reprint JULY 1998

UDC 624.154.33.04 : 006.76

© *Copyright* 1981

**BUREAU OF INDIAN STANDARDS**  
MANAK BHAVAN, 9 BAHADUR SHAH ZAFAR MARG  
NEW DELHI 110002

*Indian Standard*CODE OF PRACTICE FOR  
DESIGN AND CONSTRUCTION OF PILE  
FOUNDATIONS

## PART III UNDER-REAMED PILES

*( First Revision )*

Foundation Engineering Sectional Committee, BDC 43

*Chairman*

PROF DINESH MOHAN

*Representing*Central Building Research Institute (CSIR),  
Roorkee*Members*

DR R. K. BHANDARI

Central Building Research Institute (CSIR),  
Roorkee

SHRI I. G. CHACKO

Calcutta Port Trust, Calcutta

SHRI S. GUHA (*Alternate*)

SHRI K. N. DADINA

In personal capacity (*P 820, Block P, New Alipore,*  
*Calcutta*)

SHRI M. G. DANDAVATE

Concrete Association of India, Bombay

SHRI N. C. DUGGAL (*Alternate*)

SHRI R. K. DAS GUPTA

Simplex Concrete Piles (I) Pvt Ltd, Calcutta

SHRI H. GUHA BISWAS (*Alternate*)

SHRI A. G. DASTIDAR

In personal capacity (5, *Hungerford Court, 121*  
*Hungerford Street, Calcutta*)

SHRI V. C. DESHPANDE

Pressure Piling Co (India) Pvt Ltd, Bombay

DIRECTOR (CSMRS)

Central Water Commission, New Delhi

DEPUTY DIRECTOR (CSMRS) (*Alternate*)

SHRI A. H. DIVANJI

Asia Foundation and Construction Pvt Ltd,  
BombaySHRI A. N. JANGLE (*Alternate*)

SHRI A. GHOSHAL

Braithwaite Burn & Jessop Construction Co Ltd,  
CalcuttaSHRI N. E. A. RAGHAVAN (*Alternate*)

DR GOPAL RANJAN

University of Roorkee, Roorkee

DR SHASHI K. GULHATI

Indian Institute of Technology, New Delhi

SHRI A. VARADARAJAN (*Alternate*)*(Continued on page 2)*

© Copyright 1981

BUREAU OF INDIAN STANDARDS

This publication is protected under the *Indian Copyright Act* (XIV of 1957) and reproduction in whole or in part by any means except with written permission of the publisher shall be deemed to be an infringement of copyright under the said Act.

(Continued from page 1)

| <i>Members</i>  | <i>Representing</i>  |
|---|--|
| SHRI M. IYENGAR                                       | Engineers India Ltd, New Delhi   |
| DR R. K. M. BHANDARI ( <i>Alternate</i> )             |  |
| SHRI G. R. S. JAIN                                    | G. S. Jain & Associates, Roorkee   |
| JOINT DIRECTOR RESEARCH (SM)                          | Ministry of Railways   |
| (RDSO)  |  |
| JOINT DIRECTOR RESEARCH (B & S),                      |  |
| RDSO ( <i>Alternate</i> )                             |  |
| DR R. K. KATTI  | Indian Institute of Technology, Bombay   |
| SHRI K. K. KHANNA                                     | National Buildings Organization, New Delhi   |
| SHRI SUNIL BERRY ( <i>Alternate</i> )                 |  |
| SHRI S. R. KULKARNI                                   | M. N. Dastur and Company Pvt Ltd, Calcutta   |
| SHRI S. ROY ( <i>Alternate</i> )                      |  |
| SHRI O. P. MALHOTRA                                   | Building and Roads Branch, Public Works Department, Government of Punjab, Chandigarh |
| SHRI A. P. MATHUR                                     | Central Warehousing Corporation, New Delhi   |
| SHRI V. B. MATHUR                                     | Mckenzie's Limited, Bombay   |
| SHRI Y. V. NARASIMHA RAO                              | Bokaro Steel Plant (Steel Authority of India), Bokaro Steel City                     |
| BRIG OMBIR SINGH                                      | Engineer-in-Chief's Branch, Army Headquarters  |
| MAJ H. K. BHUTANI ( <i>Alternate</i> )                |  |
| SHRI B. K. PANTHAKY                                   | Hindustan Construction Co Ltd, Bombay  |
| SHRI V. M. MADGE ( <i>Alternate</i> )                 |  |
| PRESIDENT   | Indian Geotechnical Society, New Delhi   |
| SECRETARY ( <i>Alternate</i> )                        |  |
| PROFESSOR (CIVIL ENGG)                                | College of Engineering, Guindy, Madras   |
| ASSISTANT PROFESSOR (CIVIL ENGG) ( <i>Alternate</i> ) |  |
| SHRI M. R. PUNJA                                      | Cementation Co Ltd, Bombay   |
| SHRI A. A. RAJU                                       | Steel Authority of India, New Delhi  |
| DR V. V. S. RAO                                       | Nagadi Consultants Pvt Ltd, New Delhi  |
| SHRI ARJUN RIJHSINGHANI                               | Cement Corporation of India, New Delhi   |
| SHRI O. S. SRIVASTAVA ( <i>Alternate</i> )            |  |
| SHRI K. R. SAXENA                                     | Engineering Research Laboratories, Government of Andhra Pradesh, Hyderabad           |
| DR S. P. SRIVASTAVA                                   | United Technical Consultants Pvt Ltd, New Delhi                                      |
| DR R. KAPUR ( <i>Alternate</i> )                      |  |
| SHRI N. SIVAGURU                                      | Roads Wing, Ministry of Shipping and Transport                                       |
| SHRI S. SEETHARAMAN ( <i>Alternate</i> )              |  |
| SHRI T. N. SUBBA RAO                                  | Gammon India Ltd, Bombay   |
| SHRI S. A. REDDI ( <i>Alternate</i> )                 |  |
| SUPERINTENDING ENGINEER (DESIGN)                      | Central Public Works Department, New Delhi   |
| EXECUTIVE ENGINEER (DESIGN V) ( <i>Alternate</i> )    |  |
| SHRI M. D. TAMBEKAR                                   | Bombay Port Trust, Bombay  |
| SHRI D. AJITHA SIMHA,                                 | Director General, ISI ( <i>Ex-officio Member</i> )                                   |
| Director (Civ Engg)                                   |  |

*Secretary*

SHRI K. M. MATHUR  
Deputy Director (Civ Engg), ISI

(Continued on page 33)

# Indian Standard

## CODE OF PRACTICE FOR DESIGN AND CONSTRUCTION OF PILE FOUNDATIONS

### PART III UNDER-REAMED PILES

### ( *First Revision* )

#### 0. FOREWORD

**0.1** This Indian Standard (Part III) (First Revision) was adopted by the Indian Standards Institution on 26 May 1980, after the draft finalized by the Foundation Engineering Sectional Committee had been approved by the Civil Engineering Division Council.

**0.2** Under-reamed piles are of bored cast *in situ* and bored compaction concrete types having one or more bulbs formed by suitably enlarging the borehole for the pile stem. With the provision of bulb(s), substantial bearing or anchorage is available. These piles find application in widely varying situations in different types of soils where foundations are required to be taken down to a certain depth in view of considerations like the need (a) to avoid the undesirable effect of seasonal moisture changes as in expansive soils; (b) to reach firm strata; (c) to obtain adequate capacity for downward, upward and lateral loads and moments; or (d) to take the foundations below scour level.

**0.3** When the ground consists of expansive soil, for example black cotton soil, the bulb of the under-reamed pile provides anchorage against uplift due to swelling pressure apart from the increased bearing. In case of filled-up or otherwise weak strata overlying the firm strata, enlarged base in the form of under-reamed bulb in firm strata provides larger bearing area and piles of greater bearing capacity can be made. In loose to medium pervious sandy and silty strata, bored compaction piles can be used as the process of compaction increases the load bearing capacity of the piles. Under-reamed piles may also be used under situations where the vibration and noise caused during construction of piles are to be avoided. The provision of bulb(s) is of special advantage in under-reamed piles to resist uplift and they can be used as anchors.

**0.4** This standard was first published in 1973. This revision has been undertaken to bring it in line with other Indian Standards on pile foundation.

**0.5** The recommendations made in this code are based on the general principles applicable to pile foundations and the experience of construction of a large number of engineering works.

**0.6** In the formulation of this standard due weightage has been given to international co-ordination among the standards and practices prevailing in different countries in addition to relating it to the practices in the field in this country. Considerable assistance has been given by Central Building Research Institute, Roorkee, for preparing this standard.

**0.7** For the purpose of deciding whether a particular requirement of this standard is complied with, the final value, observed or calculated, expressing the result of a test shall be rounded off in accordance with IS : 1960\*. The number of significant places retained in the rounded off value should be the same as that of the specified value in this standard.

---

## **1. SCOPE**

**1.1** This standard (Part III) covers the design and construction of under-reamed piles having one or more bulb(s) formed along the stem.

## **2. TERMINOLOGY**

**2.0** For the purpose of this standard, the following definitions shall apply.

**2.1 Allowable Load** — The load which may be applied to a pile after taking into account its ultimate load capacity, pile spacing, overall bearing capacity of the ground below the pile, the allowable settlement, negative skin friction and the loading conditions including reversal of loads.

**2.2 Batter Pile (Raker Pile)** — The pile which is installed at an angle to the vertical.

**2.3 Bearing Pile** — A pile formed in the ground for transmitting the load of structure to the soil by the resistance developed at its tip or along its surface or both. It may be formed either vertically or at an inclination (Batter Pile) and may be required to take uplift. When it is primarily meant for resisting uplift or pull it is called an 'Anchor Pile'. If the pile supports the load primarily by resistance developed at the pile point or base it is referred to as an 'End Bearing Pile' and if the load is supported primarily by friction along its surface, the pile is termed as 'Friction Pile'.

**2.4 Bored Cast *in situ* Pile** — A pile formed within the ground by excavating or boring a hole within it, with or without the use of a temporary casing and subsequently filling it with plain or reinforced concrete. When the casing is left permanently it is termed as cased pile and when the casing

---

\*Rules for rounding off numerical values (*revised*).

is taken out it is termed as uncased pile. In installing a bored pile, the sides of the borehole (when it does not stand by itself) is required to be stabilized with the aid of a temporary casing, or with the aid of drilling mud of suitable consistency.

**2.5 Bored Compaction Pile** — A bored cast *in situ* pile with or without bulb(s) in which the compaction of surrounding ground and freshly filled concrete in pile bore is simultaneously achieved by suitable method. If the pile with bulb(s), it is known 'under-reamed bored compaction pile'.

**2.6 Cut-Off Level** — It is the level where the installed pile is cut-off to support the pile caps or beams or any other structural components at that level.

**2.7 Datum Bar** — A rigid bar placed on immovable supports.

**2.8 Factor of Safety** — The ratio of the ultimate load capacity of a pile to the safe load of a pile.

**2.9 Initial Test** — It is carried out on test pile(s) generally made for the purpose with a view to determining the safe load or ultimate load capacity or both.

**2.10 Kentledge** — Dead weight used for applying a test load on pile.

**2.11 Multi-Under-Reamed Pile** — An under-reamed pile having more than one bulb. The pile having two bulbs is known as double under-reamed pile.

**2.12 Net Displacement** — Net movement of the pile top after the pile has been subjected to a test load and subsequently released.

**2.13 Routine (Check) Tests** — It is carried out on a working pile with a view to determining displacement corresponding to the allowable load.

**2.14 Safe Load** — It is a load on a pile derived by applying a factor of safety on ultimate load capacity of pile or as determined by pile load test or as obtained in accordance with 5.2.3.3.

**2.15 Test Pile** — A pile which is selected for load-testing and which is subsequently loaded for that purpose. The test pile may form a working pile itself if subject to routine load test with up to one and one-half times the safe load in case of compression test and equal to safe load in uplift and lateral thrust.

**2.16 Total Displacement (Gross)** — The total movement of the pile top under a given load.

**2.17 Total Elastic Displacement** — This is the magnitude of the

displacement of the pile due to rebound caused at the top after removal of given test load. This comprises two components as follows:

- a) Elastic displacement of the soil participating in load transfer; and
- b) Elastic displacement of the pile shaft.

**2.18 Trial Pile** — One or more piles, which are not working pile, that may be installed initially to assess load carrying capacity of the piles. These are tested either to their ultimate bearing capacity or to twice the estimated safe load.

**2.19 Ultimate Load Capacity** — The maximum load which a pile can carry before failure of ground (when the soil fails by shear) or failure of pile materials.

**2.20 Under-Reamed Pile** — A bored cast *in situ* or bored compaction concrete pile with an enlarged bulb(s) made by either cutting or scooping out the soil or by any other suitable process.

**2.21 Working Load** — The load assigned to a pile according to design.

**2.22 Working Pile** — A pile forming part of foundation of a structural system.

### **3. NECESSARY INFORMATION**

**3.1** For the satisfactory design and construction of bored cast *in situ* and bored compacted under-reamed piles and pile foundation, the information on the following aspects is necessary:

- a) Site investigation data as laid down in IS : 1892-1979\* or any other relevant Indian Standard. Sections of trial borings, supplemented wherever appropriate by penetration tests, should incorporate data/information sufficiently on soil condition below the anticipated level of pile tip.

The nature of the subsoil both around and beneath the proposed pile should be indicated on the basis of appropriate tests of strength, compressibility, etc. Ground-water levels and conditions (such as artesian conditions) should be indicated. Results of chemical tests to ascertain the sulphate and the chloride content and ground-water should be indicated particularly in areas where large scale piling is envisaged or where such information is not generally available.

- b) A qualitative indication of the degree of expansiveness of soil is given in Appendix A. The free swell test will be carried out according to IS : 2720 (Part XL)-1977†.
- c) In case of bridge foundations, data on high flood level, maximum scouring depth, normal water level during working season, etc.

---

\*Code of practice for subsurface investigations for foundations (*first revision*).

†Method of test for soils, Part XL Determination of free swell index of soils.

In case of marine construction, necessary information as listed in IS: 4651 (Part I)-1974\* should be provided.

- d) In case rock is encountered, adequate description of the rock to convey its physical conditions as well as its strength characteristics should be indicated.

In case of weathered rock, adequate physical description and its expected physical behaviour on boring should be indicated.

- e) General plan and cross section of the building showing type of structural frame, including basement, if any, in relation to the proposed pile cap top levels.
- f) The general layout of the structure showing estimated loads, vertical and horizontal, moments and torque at the top of pile caps, but excluding the weight of the piles and caps. The top levels of finished pile caps shall be clearly indicated.
- g) It is preferable to have the dead load, equipment and live loads separately indicated. Loads and moments for wind and earthquake should also be separately indicated.
- h) Sufficient information about structures existing nearby should be provided.

**3.2** As far as possible, all information in 3.1 shall be made available to the agency responsible for the design and/or construction of piles and/or foundation work.

**3.3** The design details of pile foundation shall indicate the information necessary for setting out the layout of each pile within a cap, cut-off levels, finished cap levels, orientation of cap in the foundation plan and the safe capacity of each type of piles, etc.

**3.4** Due note shall be taken of the experience of under-reamed and other piles in the area close to the proposed site and any soil strata report thereof.

## 4. MATERIALS

**4.1 Cement** — The cement used shall conform to the requirements of IS: 269-1976†, IS: 455-1976‡, IS: 8041-1978§, IS : 6909-1973|| or IS:1489-1976¶.

---

\*Code of practice for planning and design of ports and harbours, Part I Site investigation (first revision).

†Specification for ordinary and low heat Portland cement (third revision).

‡Specification for Portland and slag cement (third revision).

§Specification for rapid hardening Portland cement.

||Specification for supersulphated cement.

¶Specification for Portland pozzolana cement (second revision).



**4.2 Steel** — Reinforcement steel shall conform to IS: 432 (Part I)-1966\* or IS: 1139-1966† or IS : 1786-1979‡ or IS : 226-1975§. The stresses allowed in steel should conform to IS : 456-1978||.

**4.2.1** For under-reamed bored compaction piles, the reinforcement cage shall be prepared by welding the hoop bars to withstand the stresses during compaction process.

### 4.3 Concrete

**4.3.1** Materials and methods of manufacture for cement concrete shall in general be in accordance with the method of concreting under the conditions of pile installation.

**4.3.2** Consistency of concrete for cast *in situ* piles shall be suitable to the method of installation of piles. Concrete shall be so designed or chosen as to have homogeneous mix having a flowable character consistent with the method of concreting under the given conditions of pile installation. In achieving these results, minor deviations in the mix proportions used in structural concrete may be necessary.

**4.3.3** Slump of concrete shall range between 100 mm to 150 mm for concreting in water-free unlined boreholes. For concreting by tremie, a slump of 150 mm to 200 mm shall be used.

**4.3.4** In case of tremie concreting for piles of smaller diameter and depth of up to 10 m, the minimum cement content should be 350 kg/m<sup>3</sup> of concrete. For piles of large diameter and/or deeper piles, the minimum cement content should be 400 kg/m<sup>3</sup> of concrete. For design purpose, the strength of concrete mix may be taken equivalent to M15 and M20, respectively, for concrete with cement content of 350 kg/m<sup>3</sup> and 400 kg/m<sup>3</sup>. Where concrete of higher strength is needed, richer concrete mix with higher cement content may be designed. In case of piles subsequently exposed to free water or in case of piles where concreting is done under water or drilling mud using methods other than the tremie, 10 percent extra cement over that required for the design grade of concrete at the specified slump shall be used subject to the minimum quantities of cement specified above.

**4.3.5** For the concrete, water and aggregates specifications laid down in IS: 456-1978|| shall be followed in general. Natural rounded shingle of appropriate size may also be used as coarse aggregate. It helps to give high slump with less water cement ratio. For tremie concreting aggregates having nominal size more than 20 mm should not be used.

\*Specification for mild steel and medium tensile steel bars and hard drawn steel wire for concrete reinforcement, Part I Mild steel and medium tensile steel bars (second revision).

†Specification for hot rolled mild steel, medium tensile steel and high yield strength steel deformed bars for concrete reinforcement (revised).

‡Specification for cold worked high strength deformed steel bars for concrete reinforcement (second revision).

§Specification for structural steel (standard quality) (fifth revision).

||Code of practice for plain and reinforced concrete (third revision).

**4.3.6** The concrete for piles in aggressive surroundings due to presence of sulphates, etc, should have a concrete mix of appropriate type of cement in suitable proportion.

**4.3.6.1** If the concentration of sulphates (measured as  $\text{SO}_3$ ) exceeds one percent in soil or 2 500 parts per million (ppm) in water a mix using 400  $\text{kg/m}^3$  of sulphate resisting Portland cement should be used. For soils with 0.5 to 1 percent of sulphates or ground water with 1 200 to 2 500 ppm, the mix should have 330  $\text{kg/m}^3$  of sulphate resisting Portland cement. For concentrations lesser than above concrete mix with 330  $\text{kg/m}^3$  ordinary Portland cement or 310  $\text{kg/m}^3$  sulphate resisting should be used. In place of ordinary Portland cement, pozzolana cement/blast furnace slag cement may be used.

**4.3.6.2** Concentration of sulphates up to 0.2 percent in soil and 300 ppm in water may be inconsequential.

**4.3.7** For bored compaction piles rapid hardening cement (*see* 4.1) shall not be used. To facilitate construction, admixtures for retarding the setting of concrete may be used.

## 5. DESIGN CONSIDERATIONS

**5.1 General** — Under-reamed pile foundations shall be designed in such a way that the load from the structure they support, can be transmitted to the soil without causing any soil failure and without causing such settlement, differential or total, under permanent transient loading as may result in structural damage and/or functional distress. The pile shaft should have adequate structural capacity to withstand all loads (vertical, axial or otherwise) and moments which are to be transmitted to the subsoil.

**5.1.1** In deep deposits of expansive soils the minimum length of piles, irrespective of any other considerations, shall be 3.5 m below ground level. If the expansive soil deposits are of shallow depth and overlying non-expansive soil strata of good bearing or rock, piles of smaller length can also be provided. In recently filled up grounds or other strata or poor bearing, the piles should pass through them and rest in good bearing strata.

**5.1.2** The diameter of under-reamed bulbs may vary from 2 to 3 times stem diameter depending upon the feasibility of construction and design requirements. In bored cast *in situ* under-reamed piles the bulb diameter shall normally be 2.5 times, and in under-reamed compaction piles two times.

**5.1.3** For piles up to 30 cm diameter, the spacing of bulbs should not exceed 1.5 times the diameter of bulb. For piles of diameter greater than 30 cm spacing can be reduced to 1.25 times the stem diameter.

**5.1.4** The top-most bulb should be at a minimum depth of 2 times the bulb diameter. In expansive soils it should also not be less than 1.75 m below ground level. The minimum clearance below the underside of pile

cap embedded in the ground and the bulb should be a minimum 1.5 times the bulb diameter.

**5.1.5** Under-reamed piles with more than two bulbs are not advisable without ensuring their feasibility in strata needing stabilization of boreholes by drilling mud. The number of bulbs in case of bored compaction piles should not exceed two in such strata.

**5.1.6** The minimum diameter of stem for borehole needing stabilization by drilling mud should be 25 cm.

**5.1.7** The minimum diameter of stem for strata consisting of harmful constituents, such as sulphates, should be 30 cm.

**5.1.8** For guidance typical details of bored cast *in situ* under-reamed pile foundations are shown in Fig. 1.

**5.1.9** For batter piles, a batter of 30° for piles in dry ground conditions and 15° with horizontal for water or drilling mud filled holes should generally not be exceeded. The under-reamed compaction piles are normally constructed up to a batter of 15°.

**5.2 Design of Piles** — The load carrying capacity of under-reamed pile depends mainly on the pile dimensions and soil strata. Axial load on a pile is transmitted by point bearing at the toe and the projected area of the bulb(s) and skin friction along the pile stem. Depending upon the nature of soil and pile geometry, in addition to the skin friction on stem, friction can develop on the soil cylinder between the extreme bulbs. In under-reamed compaction piles, the mechanism of load transfer remains the same but soil properties improved by compaction process are considered. In uplift load, point bearing component at toe is absent but unlike other straight shaft piles, point bearing on an annular projection of the bulb is present. Lateral load and moment are sustained by horizontal soil reaction developed along the pile length, which depends on several factors.

The design of piles shall be such that it has an adequate factor of safety:

- a) as a structural member to transmit the imposed loads, and
- b) against failure of strata due to reaching ultimate strength. Further it should ensure that the desired limit of settlement is not exceeded.

**5.2.1 Pile as a Structural Member** — The pile should have adequate strength to sustain the design loads. The pile cross-section should be checked for combined effect of vertical loads (compressive and uplift) and/or lateral loads and moments. The stem should be designed as a short column considering both concrete and steel (*see 5.2.2*) by the limit state method or working stress method. In case of latter, the permissible increase in stresses shall be taken for wind and seismic loads. (*see IS : 875-1964\** and *IS : 1893-1975†*.)

\*Code of practice for structural safety of buildings: Loading standards (*revised*).

†Criteria for earthquake resistant design of structures (*third revision*).

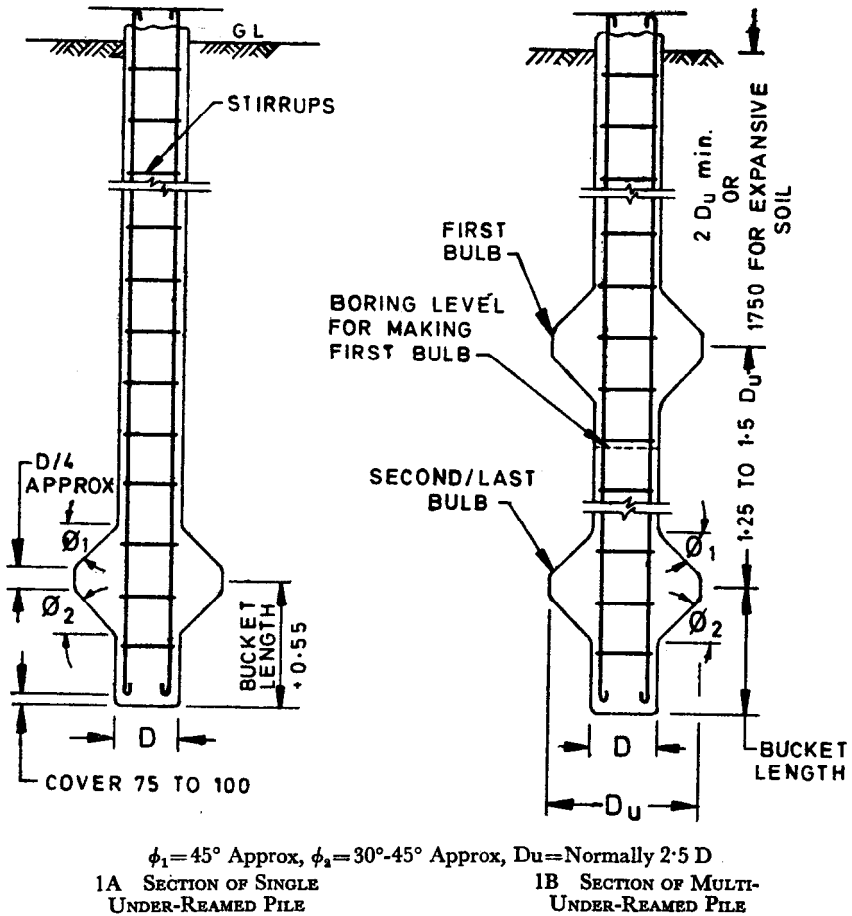

FIG. 1 TYPICAL DETAILS OF BORED CAST *in situ* UNDER-REAMED PILE FOUNDATIONS

**5.2.2 Reinforcement in Piles** — The provision of reinforcement will depend on nature and magnitude of loads, nature of strata and method of installation. It should be adequate for vertical load, lateral load and moments, acting individually or in combination. It may be curtailed at appropriate depth subject to provision given in 5.2.2.1 and 5.2.2.2.

**5.2.2.1** The minimum area of longitudinal reinforcement in stem should be 0.4 percent of mild steel (or equivalent deformed steel). Rein-

forcement is to be provided in the full length irrespective of any other considerations and is further subject to the condition that a minimum number of three 10-mm diameter mild steel or three 8-mm diameter high strength steel bars shall be provided. The transverse reinforcement as circular stirrups shall not be less than 6-mm diameter mild steel bars at a spacing of not more than the stem diameter or 30 cm whichever is less.

In under-reamed compaction piles, a minimum number of four, 12-mm diameter mild steel or four 10-mm diameter high strength steel bars shall be provided. For piles of lengths exceeding 5 m and or 37.5 cm diameter, a minimum number of six 12-mm diameter bars of mild or high strength steel shall be provided. For piles exceeding 40 cm dia, a minimum number of six 12-mm diameter mild or high strength steel bars shall be provided. The circular stirrups for piles of lengths exceeding 5 m and diameter exceeding 37.5 cm shall be of 8 mm diameter bars.

**5.2.2.2** For piles subjected to uplift loads, adequate reinforcement shall be provided to take full uplift which shall not be curtailed at any stage.

**5.2.2.3** For piles up to 30 cm diameter, if concreting is done by tremie, equivalent amount of steel placed centrally may be provided.

**5.2.2.4** The minimum clear cover over the longitudinal reinforcement shall be 40 mm. In aggressive environment of sulphates, etc, it may be increased to 75 mm.

**5.2.3 Safe Load** — Safe load on a pile can be determined from (a) calculating ultimate load from soil properties and applying suitable factor of safety, (b) load test on pile as provided in IS : 2911 (Part IV)-1979\*, and (c) safe load tables.

**5.2.3.1 Safe load from ultimate load capacity** — The ultimate load capacity of a pile can be calculated from soil properties. The soil properties required are strength parameters, cohesion, angle of internal friction and soil density. If these properties are not available directly from laboratory and field tests, they may be indirectly obtained from *in situ* penetration test data [IS : 4968 (Part II)-1976† and IS : 6403-1971‡]. The success of the approach essentially depends how realistically the soil properties are determined or deduced.

a) *Clayey soils*

For clayey soils the ultimate load carrying capacity of an under-reamed pile may be worked out from the following expressions:

$$Q_u = A_p \cdot N_c C_p + A_a \cdot N_c \cdot C'_a + C'_a \cdot A'_s + \alpha \cdot C_a \cdot A_s$$

where

$$\begin{aligned} Q_u \text{ (kg)} &= \text{ultimate bearing capacity of pile;} \\ A_p \text{ (cm}^2\text{)} &= \text{cross-sectional area of pile stem at toe level;} \end{aligned}$$

\*Code of practice for design and construction of pile foundations: Part IV Load test on piles.

†Method for subsurface sounding for soils: Part III Static cone penetration test (*first revision*).

‡Code of practice for determination of allowable bearing pressure on shallow foundations.

- $N_c$  = bearing capacity factor, usually taken as 9;  
 $C_p$  (kgf/cm<sup>2</sup>) = cohesion of the soil around toe;  
 $A_a$  (cm<sup>2</sup>) =  $\pi/4 (D_u^2 - D^2)$  where  $D_u$ (cm) and  $D$  (cm) are the under-reamed and stem diameter, respectively;  
 $C'_a$  (kgf/cm<sup>2</sup>) = average cohesion of soil around the under-reamed bulbs;  
 $\alpha$  = reduction factor (usually taken 0.5 for clays);  
 $C_a$  (kgf/cm<sup>2</sup>) = average cohesion of the soil along the pile stem;  
 $A_s$  (cm<sup>2</sup>) = surface area of the stem; and  
 $A'_s$  (cm<sup>2</sup>) = surface area of the cylinder circumscribing the under-reamed bulbs.

The above expression holds for the usual spacing of under-reamed bulbs spaced at not more than one-and-a-half times their diameter.

NOTE 1 — The first two terms in formula are for bearing and the last two for friction components.

NOTE 2 — If the pile is with one bulb only the third term will not occur.

NOTE 3 — For calculating uplift load first term will not occur in formula.

b) *Sandy soils*

For sandy soils the following expression be used :

$$Q_u = A_p \cdot \left( \frac{1}{2} \cdot D \cdot \lambda \cdot N_\lambda + \lambda \cdot d_f \cdot N_q \right) + A_a \left( \frac{1}{2} \cdot D_u \cdot n \cdot \lambda \cdot N_\lambda + \lambda \cdot N_q \sum_{r=1}^{r=n} d_r \right) + \frac{1}{2} \cdot \pi \cdot D \cdot \lambda \cdot K \tan \delta \times (d_1^2 + d_f^2 - d_n^2)$$

where

- $A_p$  (cm<sup>2</sup>) =  $\pi/4 \cdot D^2$ , where  $D$  (cm) is stem diameter;  
 $A_a$  (cm<sup>2</sup>) =  $\pi/4 (D_u^2 - D^2)$  where  $D_u$  (cm) is the under-reamed bulb diameter;  
 $n$  = number of under-reamed bulbs;  
 $\lambda$  (kg/cm<sup>3</sup>) = average unit weight of soil (submerged unit weight in strata below water table);  
 $N_\lambda$  and  $N_q$  = bearing capacity factors depending upon the angle of internal friction;  
 $d_f$  (cm) = depth of the centre of different under-reamed bulbs below ground level;  
 $d_p$  (cm) = total depth of pile below ground level;  
 $K$  = earth pressure coefficient (usually taken 1.75 for sandy soils);  
 $\delta$  = angle of wall friction (may be taken equal to the angle of internal friction  $\phi$ );  
 $d_1$  (cm) = depth of the centre of first under-reamed bulb; and  
 $d_n$  (cm) = depth of the centre of the last under-reamed bulb.

NOTE 1 — The first two terms in the formula are for bearing component and the last one for friction component.

NOTE 2 — For uplift bearing on tip,  $A_p$  will not occur.

## IS : 2911 (Part III) - 1980

NOTE 3 —  $N_{\lambda}$  will be as specified in IS : 6403-1971\* and  $N_q$  will be taken from Fig. 2. This factor, apart from the angle of internal friction  $\phi$  depends upon the method of installation of pile and the component containing this factor will generally be over estimated (up to about twice) in bored piles.

### c) *Soil strata having both cohesion and friction*

In soil strata having both cohesion and friction or in layered strata having two types of soil, the bearing capacity may be estimated using both the formula. However, in such cases the load tests will be a better guide.

### d) *Compaction piles in sandy strata*

For bored compaction piles in sandy strata, the formula in 5.2.3.1(b) shall be applicable but the modified value of  $\phi$  will be used as given below:

$$\phi_1 = (\phi + 40)/2$$

where

$\phi$  = angle of internal friction of virgin soil.

The values of  $N_{\lambda}$ ,  $N_q$  and  $\delta$  are taken corresponding to  $\phi_1$

The value of the earth pressure coefficient  $K$  will be 3.

### e) *Piles resting on rock*

For piles resting on rock, the bearing component will be obtained by multiplying the safe bearing capacity of rock with bearing area of pile stem plus the bearing provided by the bulb portion.

### f) *Factors of safety*

To obtain safe load in compression and uplift from ultimate load capacity generally the factors of safety will be 2.5 and 3, respectively. But in case of bored compaction piles with bulb diameter twice the shaft diameter, the factor of safety in compression should be taken 2.25.

**5.2.3.2 Safe load from pile load tests** — The safe load on pile(s) in compression uplift and lateral can be determined by carrying out load test on piles in accordance with IS : 2911 (Part IV)-1979†. In sizable work (more than two hundred piles) where detailed information about the strata and the guidance of past experience is not available, there should be a minimum of two pile load tests before finalizing the safe load on piles.

NOTE — It is unlikely that two similar pile load tests give the same load-deflection behaviour. Also, ground conditions, position of water table, moisture content in soil and desiccation of top strata, can affect the load tests conducted at different times of the year. These factors should be kept in view while deciding the safe load.

**5.2.3.3** In the absence of actual tests and detailed investigations, the safe load on under-reamed piles of bulb diameter 2.5 times the stem diameter may be taken as given in Appendix B.

\*Code of practice for determination of allowable bearing pressure on shallow foundations.

†Code of practice for design and construction of pile foundations: Part IV Load test on piles.

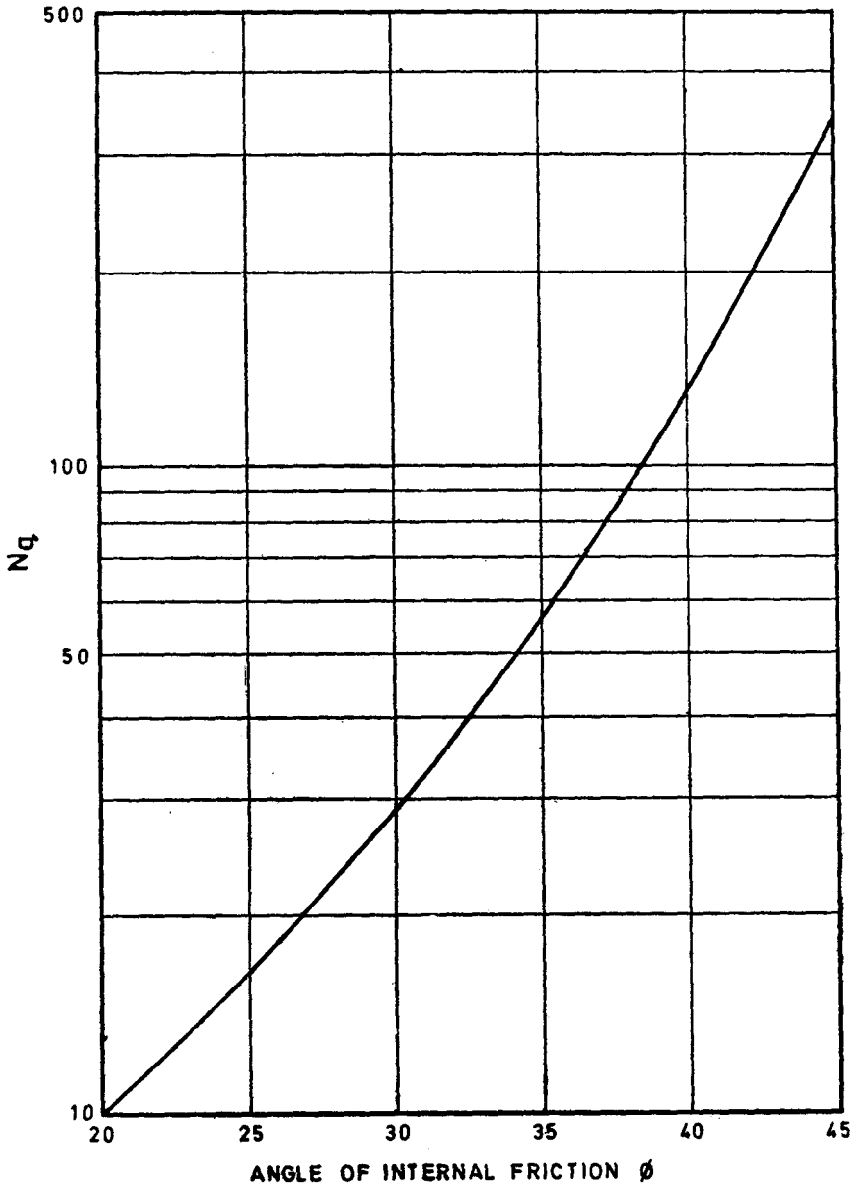
FIG. 2 BEARING CAPACITY FACTOR  $N_q$



**5.2.3.4** The lesser of the two safe loads obtained from **5.2.3.1** and **5.2.3.3** should be used in designs. Higher values can be used if established by initial load tests.

**5.2.3.5** *Permissible increase over safe load on piles*

- a) *Overloading* — When a pile designed for a certain safe load is found to fall just short of the required load carried by it, an overload of up to 10 percent of the safe load on pile may be allowed on each pile. The total overloading on group should not be more than 10 percent of the safe load on group, nor more than 40 percent of the safe load on single pile.
- b) *Transient loading* — The maximum permissible increase over the safe load of a pile as arising out of wind loading is 25 percent. In case of loads and moments arising out of earthquake effects the increase over the safe load on a pile may be limited to the provisions contained in IS : 1893-1975\*. For seismic loads, under-reamed piles shall be treated as point bearing piles. The seismic and wind forces will not be considered to act simultaneously. For transient loading arising out of superimposed loads, no increase generally may be allowed. For broken wire conditions in transmission line tower foundations, permissible increase will be as provided in IS : 4091-1979†.

**NOTE** — If any increase in load on a pile has already been permitted for reasons other than **5.2.3.5**, the total increase over safe load including those of **5.2.3.5** shall not exceed 50 percent.

**5.2.4** *Negative Skin Friction or Drag Down Force* — When a soil stratum through which a pile shaft has penetrated into an underlying hard stratum, compresses as a result of either it being unconsolidated or it being under a newly placed fill or as a result of remoulding during driving of the pile, a drag-down force is generated into the pile shaft up to a point in depth where the surrounding soil does not move downward relative to the pile shaft.

**NOTE** — Estimation of this drag-down force is still under investigation, although a few empirical approaches are in use. The concept is constantly under revision and, therefore, no definite proposal is embodied in this standard. (Recognition of the existence of such a phenomenon shall be made and suitable reduction shall be made to the allowable load where appropriate. There is no evidence to show that the use of drilling fluids for the construction of piles affects the skin friction.)

**5.2.5** *Lateral Load on Piles* — A pile may be subjected to transverse force from a number of causes, such as wind, earthquake, water current, earth pressures, effect of moving vehicles or ships, plant and equipment, etc. The lateral load carrying capacity of a single pile depends not only on the horizontal subgrade modulus of the surrounding soil but also on the structural strength of the pile shaft against bending consequent upon application of a lateral load. While considering lateral load on piles, effect of other

---

\*Criteria for earthquake resistant design of structures (*third revision*).

†Code of practice for design and construction of foundations for transmission line towers and poles (*first revision*).

existent loads including the axial load on the pile should be taken into consideration for checking the structural capacity of the shaft.

Piles under the action of lateral load and moment can be analysed by the modulus of subgrade reaction approaches. Due to the presence of bulbs, under-reamed piles tend to behave more as rigid piles and the analysis can be done on rigid pole basis. Normally reinforced long single bulb piles which are not rigid may be analysed after the generalized solutions of Matlock and Reese for sandy soils and Broms for clayey soils. For lateral loads with or without axial loads, up to those given in the Table 1 of Appendix B, no analysis may be necessary, if external moment is not acting. In the absence of actual *in situ* test values from prototype pile load test, the modulus of subgrade reaction values may be taken from the Table 2 given in Appendix C.

**NOTE** — It may be kept in view that modulus of subgrade reaction is a critical factor in the above analysis, yet there is no precise method for determining it. Therefore, it will be realistic to ascertain the adequacy of design by field tests.

**5.2.6 Batter Piles (Raker Piles)** — Raker piles are normally provided where vertical piles cannot resist the required applied horizontal forces. In the preliminary design the load on raker pile is generally considered to be axial. The distribution of load between raker and vertical piles in a group may be determined by graphical or analytical methods. Where necessary, due consideration should be given to secondary bending induced as a result of the pile cap movement, particularly when the cap is rigid. Free standing raker piles are subjected to bending moments due to their own weight or external forces from other causes. Raker piles embedded in fill or consolidating deposits may become laterally loaded owing to the settlement of the surrounding soil.

### 5.2.7 Spacing of Piles

**5.2.7.1** Spacing of piles shall be considered in relation to the nature of ground, the types of piles and the manner in which the piles transfer the load to the ground.

**5.2.7.2** Generally the centre to centre spacing for bored cast *in situ* under-reamed piles in a group should be two times the bulb diameter ( $2D_u$ ). It shall not be less than  $1.5 D_u$ . For under-grade beams the maximum spacing of piles should generally not exceed 3 m. In under-reamed compaction piles, generally the spacing should not be less than  $1.5 D_u$ . If the adjacent piles are of different diameter, an average value of bulb diameter should be taken for spacing.

### 5.2.8 Grouping and Layout

**5.2.8.1** For bored case *in situ* under-reamed piles at usual spacing of  $2 D_u$ , the group capacity will be equal to the safe load of individual pile multiplied by the number of piles in the group. For piles at a spacing of  $1.5 D_u$  the safe load assigned per pile in a group should be reduced by 10 percent.

In under-reamed compaction piles, at the usual spacing of 1.5  $D_u$  the group capacity will be equal to the safe load on individual pile multiplied by the number of piles in the group.

NOTE — In under-reamed compaction piles, the capacity of the group may be more than given in 5.2.8.1 on account of the compaction effect.

**5.2.8.2** In non-expansive soils, when the cap of the pile group is cast directly on reasonably firm stratum it may additionally contribute towards the bearing capacity of the group.

**5.2.8.3** The settlement of pile groups depends upon soil and pile characteristics, spacing, group size method of installation and magnitude and nature of loading. In clays sometimes long term settlements can become important while in sands almost all the settlements will be over quickly.

A group of free standing piles is likely to settle more than a single pile but this increase may be marginal if the safe load on the piles is according to 5.2.3 and 5.2.8.1.

NOTE 1 — The settlement, in case of piles in sand, are generally computed from empirical relations. A suggested relationship for estimating settlements of free standing under-reamed pile groups in sands is:

$$S_g = \sqrt{B/D} \times S_1$$

where

- $S_g$  = settlement of group in cm,
- $S_1$  = settlement of single pile in cm; piles are under the same safe load per pile,
- $B$  = distance between outer piles centre in cm, and
- $D$  = pile stem diameter in cm.

In clays the immediate settlements are computed using theory of elasticity and the long term settlements by consolidation theory. For the later, the pile group is considered as a footing at the centres of the lowermost bulbs.

It may be noted that computed settlements, by the above approaches particularly for piles in clay, are very large as compared to actually occurring in practice.

NOTE 2 — For the groups with caps resting on ground settlements are comparable with an isolated pile.

NOTE 3 — In the case of under-reamed compaction piles with cap resting on ground, which is very often the case, the settlements of groups may be even less than the settlement of an isolated pile.

**5.2.8.4** In case of structure supported on single pile/group of piles, resulting into large variation in the number of piles from column to column it is likely that a high order of differential settlement may result depending on the type of subsoil supporting the piles. Such high order of differential settlement may be either catered for in the structural design or it may be suitably reduced by judicious choice of variations in the actual pile loadings. For example, a single pile cap may be loaded to a level higher than that of a pile in a group in order to achieve reduced differential settlement between two adjacent pile caps supported on differential number of piles.

**5.2.8.5** In load bearing walls, piles should generally be provided under all wall junctions to avoid point loads on beams. Positions of intermediate piles are then decided by keeping door openings fall in between two piles as far as possible.

### 5.3 Grade Beams

**5.3.1** The grade beams supporting the walls shall be designed taking due account of arching effect due to masonry above beam. The beam with masonry due to composite action behaves as a deep beam.

For the design of beams, a maximum bending moment of  $wl^2/50$ , where  $w$  is uniformly distributed load per metre run (worked out by considering a maximum height of two storeys in structures with load bearing walls and one storey in framed structures) and  $l$  is the effective span in metres, will be taken if the beams are supported during construction till the masonry above it gains strength. The value of bending moment shall be increased to  $wl^2/30$  if the beams are not supported. For considering composite action the minimum height of wall shall be 0.6 times the beam span. The brick strength should not be less than 30 kgf/cm<sup>2</sup>. For concentrated loads and other loads which come directly over the beam, full bending moment should be considered.

**5.3.2** The minimum overall depth of grade beams shall be 150 mm. The reinforcement at bottom should be kept continuous in all the beams and an equal amount may be provided at top to a distance of quarter span both ways from the pile centres.

The longitudinal reinforcement both at bottom and top should not be less than three bars of 10 mm diameter mild steel (or equivalent deformed steel).

Stirrups of 6-mm diameter bars should be at a 300 mm spacing which should be reduced to 100 mm at the door openings near the wall edge up to a distance of three times the depth of beam. No shear connectors are necessary in wall.

**5.3.3** In expansive soil, the grade beams shall be kept a minimum of 80 mm clear off the ground. In other soils, the beams may rest on ground over a levelling concrete course of about 80 mm (see Fig. 3). In this case, part load may be considered to be borne by the ground and it may be accounted for in the design of piles. However, the beams should be designed as per clause **5.3.1**.

**5.3.4** In case of exterior beams over piles in expansive soils, a ledge projection of 75 mm thickness and extending 80 mm into ground (see Fig. 3) shall be provided on outer side of beam.

**5.4 Design of Pile Cap** — Pile caps are generally designed considering pile reaction as either concentrated loads or distributed loads. The depth of pile cap should be adequate for the shear for diagonal tension and it should also provide for necessary anchorage of reinforcement both for the column and the piles.

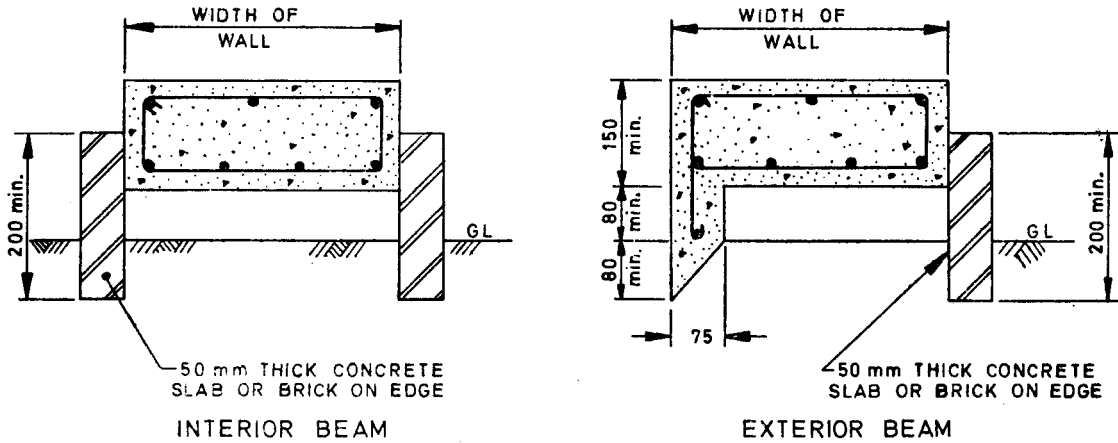

3A BEAMS IN EXPANSIVE SOILS

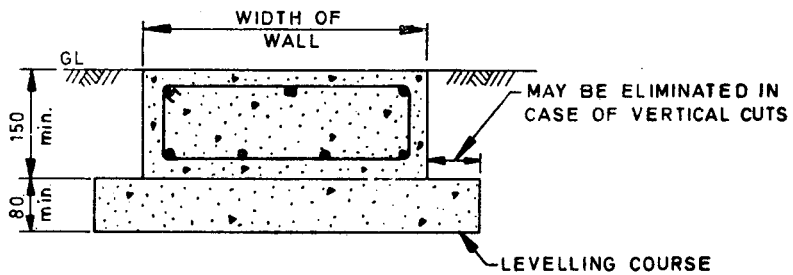

3B BEAM IN NON-EXPANSIVE SOILS

3A BEAMS IN EXPANSIVE SOILS                      3B BEAMS IN NON-EXPANSIVE SOILS  
*All dimensions are in millimetres*

FIG. 3 TYPICAL SECTIONS OF GRADE BEAMS

**5.4.1** The pile caps may be designed by assuming that the load from column or pedestal is dispersed at  $45^\circ$  from the top of the cap up to the mid-depth of the pile cap from the base of the column or pedestal. The reaction from piles may also be taken to be distributed at  $45^\circ$  from the edge of the pile, up to the mid-depth of the pile cap. On this basis, the maximum bending moment and shear forces should be worked out at critical sections.

**5.4.2** When pile reactions are considered as point loads, the critical section for shear in diagonal tension is taken at a distance equal to half the depth of cap from the face of the column or pedestal. For bending moment and shear for bond, the critical section is taken at the face of the column or pedestal. In computing the external shear or the critical section the entire reaction of any pile of diameter  $D$  whose centre is located at  $D/2$  or more outside the section shall be assumed as producing shear on the section; the reaction from any pile whose centre is located at  $D/2$  or more inside the section shall be assumed as producing no shear on the section.

For intermediate positions of the pile centre, the portion of the pile reaction to be assumed as producing shear on the section shall be based on straight line interpolation between full value at  $D/2$  outside the section and zero value inside the section.

**5.4.3** The cap may also be designed as a solid slab carrying concentrated loads from piles. A square/rectangular pile cap can be divided in four triangular/trapezoidal areas by drawing diagonal lines at  $45^\circ$  from the corners. When the pile is cut by the line, the load on this pile is shared equally between the adjacent areas. The reaction of piles under an area will be taken towards producing shear. The bending moment are assumed to act from the centre of piles under an area at the face of the nearest pedestal or column.

**5.4.4** Full dimension of the cap shall be taken as width to analyse the section for bending and shear in respective direction. Method of analysis and allowable stresses may be according to IS: 456-1978\*.

**5.4.5** The clear overhang of the pile cap beyond the outer most pile in the group shall normally be 100 to 150 mm, depending upon the pile size.

**5.4.6** The cap is generally cast over a 75 mm thick levelling course of concrete. The clear cover for main reinforcement in the cap slab shall be not less than 75 mm.

**5.4.7** The pile should project 40 mm into the cap concrete.

## **6. EQUIPMENT AND ACCESSORIES**

**6.1** The selection of equipment and accessories will depend upon the type of under-reamed piles, site conditions and nature of strata. Also it will depend on economic considerations and availability of manually or power operated equipment.

\*Code of practice for plain and reinforced concrete (*third revision*).

**6.2** A typical list of equipment for manual construction is given in Appendix D.

**6.3** Bore holes may be made by earth augers. In case of manual boring, an auger boring guide shall be used to keep the bores vertical or to the desired inclination and in position.

After the bore is made to the required depth, enlarging of the base shall be carried out by means of an under-reaming tool.

**6.4** In ground with high water table having unstable pile bores, boring and under-reaming may be carried out using a suitable drilling mud. General guidelines for bentonite drilling mud are given in Appendix E. In normally met soil strata, drilling mud can be poured from top while boring and under-reaming can be done by normal spiral earth auger and under-reamer. The level of drilling mud should always be about one metre above water table or the level at which caving in occurs. In case of very unstable strata with excessive caving in, continuous circulation of drilling mud using suitable pumping equipment and tripod, etc, alongwith modified auger and under-reamer may be used.

**6.5** Sometimes permeable strata overlying a rim clayey stratum may be cased and normal boring and under-reaming operation may be carried out in clayey stratum.

**6.6** To avoid irregular shape and widening of bore hole in very loose strata at top, a casing pipe of suitable length may be used temporarily during boring and concreting.

**6.7** For improved control over the inclination of batter piles, a tripod hoist with fixed pully should be used for lowering in of under-reaming tools.

**6.8** For placing the concrete in bore holes full of drilling mud or subsoil water, tremie pipe of not less than 150 mm diameter with flap valve at the bottom should be used.

**6.9** For batter under-reamed piles, the reinforcement cage should be placed guiding it by a chute or any other suitable method. If concreting is not done by tremie, it should be done by chute.

**6.10** In under-reamed compaction piles, suitable devices should be used for guiding the movement of drop weight and specified core assembly for its vertical driving. For operating the drop weights of adequate capacity, suitable winch with hoisting attachment should be used.

## **7. CONSTRUCTION**

**7.1** Under-reamed piles may be constructed by selecting suitable installation techniques at a given site depending on subsoil strata conditions and type of under-reamed pile and number of bulbs.

**7.2** In construction with the equipment given in 6, initially boring guide is fixed with its lower frame levelled for making desired angular adjustment for piles at batter. Boring is done up to required depth and under-reaming is completed.

**7.2.1** In order to achieve proper under-reamed bulb, the depth of bore hole should be checked before starting under-reaming. It should also be checked during under-reaming and any extra soil at the bottom of bore hole removed by auger before reinserting the under-reaming tool.

**7.2.2** The completion of desired under-reamed bulb is ascertained by (a) the vertical movement of the handle, and (b) when no further soil is cut.

**7.2.3** In double or multi-under-reamed piles, boring is first completed to the depth required for the first (top) under-ream only and after completing the under-reaming, boring is extended further for the second under-ream and the process is repeated.

**7.3 Control of Alignment** — The piles shall be installed as correctly as possible at the correct location and truly vertical (or at the specified batter). Great care shall be exercised in respect of single pile or piles in two-pile groups under a column. As a guide, for vertical piles a deviation of 1.5 percent and for raker piles a deviation of 4 percent shall not normally be exceeded. In special cases, a closer tolerance may be necessary. Piles shall not deviate more than 75 mm or one quarter the stem diameter, whichever is less (75 mm or  $D/10$  whichever is more in case of piles having diameter more than 600 mm) from the designed position at the working level. In the case of single pile under a column, the positional deviation should not be more than 50 mm or one quarter of the stem diameter whichever is less (100 mm in case of piles having diameter more than 600 mm). For piles where cut-off is at substantial depths, the design should provide for the worst combination of the above tolerances in position and inclination.

In case of piles deviating beyond these limits, corrective measures where necessary may be taken in the form of increasing pile size, provision of extra reinforcement in the pile, redesign of pile cap and pile ties. If the resulting eccentricity cannot be taken care of by the above measures, the piles should be replaced or supplemented by one or more additional piles.

**NOTE** — In case of raker piles up to a rake of 1 in 6, there may be no reduction in the capacity of the pile unless otherwise stated.

**7.4** Concreting shall be done as soon as possible after completing the pile bore. The bore hole full of drilling mud should not be left unconcreted for more than 12 to 24 hours depending upon the stability of bore hole.

**7.5** For placing concrete in pile bores, a funnel should be used and method of concreting should be such that the entire volume of the pile bore is filled



up without the formations of voids and/or mixing of soil and drilling fluid in the concrete.

**7.5.1** In empty bore holes for under-reamed piles a small quantity of concrete is poured to give about a 100 mm layer of concrete at the bottom. Reinforcement is lowered next and positioned correctly. Then concrete is poured to fill up the bore hole. Care should be taken that soil is not scrapped from sides if rodding is done for compaction. Vibrators shall not be used.

**7.5.2** If the water is confined up to the bucket length portion at the toe and seepage is low, the water should be bailed out and concreting should be done as in **7.5.1**.

**7.5.3** In case the pile bore is stabilized with drilling mud or by maintaining water head within the bore hole, the bottom of bore hole shall be carefully cleaned by flushing it with fresh drilling mud, and pile bore will be checked for its depth immediately before concreting.

Concreting shall be done by tremie method. The tremie should have a valve at its bottom and lowered with its valve closed at the start and filled up with concrete. The valve is then opened to permit the flow of concrete which permits the upwards displacement of drilling mud. The pouring should be continuous and tremie is gradually lifted up such that the tremie pipe opening remains always in the concrete. If the final stage the quantity of concrete in tremie should be enough so that on final withdrawal some concrete spills over the ground.

**NOTE 1** — The concrete should be coherent, rich in cement (not less than 350 kgf/m<sup>3</sup>) and of slump not less than 150 mm.

**NOTE 2** — The tremie pipe should always penetrate well into the concrete with an adequate margin of safety against accidental withdrawal of the pipe is surged to discharge the concrete.

**NOTE 3** — The pile should be concreted wholly by tremie and the method of deposition should not be changed part way up the pile, to prevent the laitance from being entrapped within the pile.

**NOTE 4** — All tremie tubes should be scrupulously cleaned before and after use.

**NOTE 5** — Normally concreting of the piles should be uninterrupted. In the exceptional case of interruption of concreting, but which can be resumed within 1 or 2 hours, the tremie shall not be taken out of the concrete. Instead it shall be raised and lowered slowly, from time to time to prevent the concrete around the tremie from setting. Concreting should be resumed by introducing a little richer concrete with a slump of about 200 mm for easy displacement of the partly set concrete. If the concreting cannot be resumed before final set-up of concrete already placed, the pile so cast may be rejected, or used with modifications.

**NOTE 6** — In case of withdrawal of tremie out of the concrete, either accidentally or to remove a choke in the tremie, the tremie may be re-introduced in a manner to prevent impregnation of laitance or scum lying on the top of the concrete already deposited in the bore.

**7.5.4** In inclined piles, the concreting should be done through achute or by tremie method.

**7.5.5** For under-reamed bore compaction piles, the pile bore is first filled up without placing any reinforcement. Concreting is done as in 7.5.1 depending upon situation. Soon after, the specified core assembly shall be driven and extra concrete shall be poured in simultaneously to keep the level of concrete up to ground level. If hollow driving pipe is used in core assembly, the pipe shall be withdrawn after filling it with fresh concrete which will be left behind.

NOTE — In under-reamed bored compaction piles, concreting should be uninterrupted and notes (5) and (6) under clause 7.5.3 will not apply.

**7.5.6** The top of concrete in a pile shall be brought above the cut-off level to permit removal of all laitance and weak concrete before capping and to ensure good concrete at the cut-off level for proper embedment into the pile cap.

**7.5.7** Where cut-off level is less than 1.5 metre below working level, concrete shall be cast to a minimum of 300 mm above cut-off level. For each additional 0.3 m increase in cut off level below working level, additional coverage of 50 mm minimum shall be allowed. Higher allowance may be necessary depending on the length of the pile. When concrete is placed by tremie method, it shall be cast to the piling platform level to permit overflow of concrete for visual inspection or to a minimum of one metre above cut-off level. In the circumstance where cut-off level is below ground water, the need to maintain a pressure on the unset concrete equal to or greater than water pressure should be observed and accordingly length of extra concrete above cut-off level shall be determined.

**7.5.8 Defective Pile** — In case, defective piles are formed, they shall be removed or left in place whichever is convenient without affecting performance of the adjacent piles or the cap as a whole. Additional piles shall be provided to replace them as directed.

**7.5.9** Any deviation from the designed location alignment or load capacity of any pile shall be noted and adequate measures taken well before the concreting of the pile cap and plinth beam if the deviations are beyond the permissible limit.

**7.5.10 Estimation of Concrete Quantity** — The extra concrete required for each bored cast *in situ* under-reamed bulb of 2.5 times the stem diameter may be taken equal to a stem length of 4 to 4.5 times its diameter, depending on the nature of strata and other site conditions. The volume of concrete actually placed shall be observed in the case of few piles initially cast and the average figure obtained may be used as a guide for working out the quantities of the concrete and cement for subsequent piles.

For under-reamed compaction piles the amount of concrete used is about 1.2 times of the under-reamed cast *in situ* piles.

NOTE — If the estimates of concrete consumption is on the volume of bore holes and not on the basis of concrete quantity actually consumed, the concrete used may be found smaller than estimated and cement consumption may work out to be less.

**7.5.11 Recording of Pile Details** — A competent person at site should keep records of necessary information about the construction of piles. The following may be recorded:

- a) Date and sequence of installation of piles in a group;
- b) *Pile details* — Length, diameter of stem and bulbs, number of bulbs, type of pile, reinforcement, etc;
- c) Cut-off level and working level;
- d) Method of boring;
- e) Ground water level;
- f) Any other information.

## APPENDIX A

[Clause 3.1(b)]

### DEGREE OF EXPANSIVENESS

**A-1.** The degree of expansiveness and consequent damage to the structures with light loading may be qualitatively judged as shown below:

| <i>Degree of<br/>expansiveness</i> | <i>Differential free<br/>swell, percent</i> |
|------------------------------------|---|
| Low                                | Less than 20                                |
| Moderate                           | 20 to 35                                    |
| High                               | 35 to 50                                    |
| Very high                          | Greater than 50                             |

**A-1.1** In areas of soil showing high or very high differential free swell values, conventional shallow strips footings may not be adequate.

## APPENDIX B

(Clauses 5.2.3.3 and 5.2.5)

## SAFE LOAD ON UNDER-REAMED PILES

**B-1. SAFE LOAD TABLE**

**B-1.1** The safe bearing, uplift and lateral loads for under-reamed piles given in Table 1 apply to both medium compact ( $10 < N < 30$ ) sandy soils and clayey soils of medium ( $4 < N < 8$ ) consistency including expansive soils. The values are for piles with bulb diameter equal to two-and-a-half times the shaft diameter.

The columns (3) and (4) of on Table 1 provide the minimum pile lengths for single and double under-reamed piles, respectively, in deep deposit of expansive soils. Also the length given for 375 mm diameter double under-reamed piles and more in other soils are minimum. The values given for double under-reamed piles in columns (9) and (13) are only applicable in expansive soils. The reinforcement shown is mild steel and it is adequate for loads in compression and lateral thrusts [Columns (8), (9), (16) and (17)]. For uplift [Column (12) and (13)], requisite amount of steel should be provided. In expansive soils, the reinforcement shown in Table 1 is adequate to take upward drag due to heaving up of the soil.

The concrete considered is M 15. The cover requirements will be as provided in 5.2.2.

**B-1.2** Safe loads for piles of lengths different from those shown in Table 1 can be obtained considering the decrease or increase as from columns 10, 11, 14 and 15 for the specific case.

**B-1.3** Safe loads for piles with more than two bulbs in expansive soils and more than one bulb in all other soils (including non-expansive clayey soils) can be worked out from Table 1 by adding 50 percent of the loads shown in columns (8) or (12) for each additional bulb in the values given in these columns. The additional capacity for increased length required to accommodate bulbs should be obtained from column (10) and (14).

**B-1.4** Values given in columns (16) and (17) for lateral thrusts may not be increased or decreased for change in pile lengths. Also for multi-under reamed piles the values should not increase than those given in column (17). For longer and/or multi-under reamed piles higher lateral thrusts may be adopted after establishing from field load tests.

**B-1.5** For dense sandy ( $N \geq 30$ ) and stiff clayey ( $N \geq 8$ ) soils, the safe loads in compression and uplift obtained from Table 1 may be increased by 25 percent. The lateral thrust values should not be increased unless the stability and strength of top soil (strata up to a depth of about three times the pile shaft diameter) is ascertained and found adequate. For piles in

loose ( $4 < N \leq 10$ ) sandy and soft ( $2 < N \leq 4$ ) clayey soils, the safe loads should be taken 0.75 times the values shown in the Table. For very loose ( $N \leq 4$ ) sandy and very soft ( $N \leq 2$ ) clayey soils the values obtained from the Table should be reduced by 50 percent.

**B-1.6** The safe loads obtained from Table 1, should be reduced by 25 percent if the pile bore holes are full of subsoil water or drilling mud during concreting. No such reduction may be done if the water is confined to the shaft portion below the bottom-most bulb.

**B-1.7** The safe loads in uplift and compression given by in Table 1 or obtained in accordance with **B-1.2** to **B-1.6** should be reduced by 15 percent for piles with bulb of twice the stem diameter. But no such reduction is required for lateral loads shown in Table 1. •

**B-1.8** The safe loads for under-reamed compaction piles can be worked out by increasing the safe load of equivalent bored cast *in situ* under-reamed pile obtained from Table 1 by 1.5 times in case of medium ( $10 < N < 30$ ) and 1.75 times in case of loose to very loose ( $N \leq 10$ ) sandy soils. Depending upon the nature and initial compactness of strata, pile geometry and lay-out of piles, this increase may be up to a factor of 2 and initial load tests are suggested to arrive at final safe load values for design in case of sizable works. The values of lateral loads should not be increased by more than 1.5 times in all cases. In obtaining safe load of compaction pile the reduction for pile bore holes full of subsoil water or drilling mud during concreting should be taken 15 percent instead of 25 percent as given in **B-1.6**. The reduction for piles with twice the bulb diameter is to be taken 10 percent instead of 15 percent as given in **B-1.7**. The provision of reinforcement in under-reamed compaction piles will also be guided as stipulated in **5.2.2.1**.

**B-1.9** The safe loads in Table 1, and the recommendations made to obtain safe load in different cases (**B-1.2** to **B-1.8**) are based on extensive pile load tests. The loads thus obtained may be taken equal to two-thirds the loads corresponding to deflection of 12 mm for loads in compression and uplift. The deflections corresponding to respective safe loads will be about 6 mm and 4 mm. The deflection at safe lateral load will be about 4 mm. The values given in Table 1 will be normally on conservative side. For working out ultimate compressive and uplift loads, if defined as loads corresponding to 25 mm deflection on load-deflection curve, the value obtained from Table 1 can be doubled. But in case of lateral thrust twice the values in Table 1 should be considered corresponding to deflection of 12 mm only.

**B-1.10** The permissible increase over safe loads obtained from Table 1 should be taken as stipulated in **5.2.3.5** for respective conditions. Also the group capacity should be obtained in accordance with **5.2.8**.

**TABLE 1 SAFE LOAD FOR VERTICAL BORED CAST *IN SITU* UNDER-REAMED PILES IN SANDY AND CLAYEY SOILS INCLUDING BLACK COTTON SOILS**

| SIZE              |                        | LENGTH              |                     | MILD STEEL REINFORCEMENT   |        |                                | COMPRESSION         |                     |                            |                            | SAFE LOADS IN UPLIFT RESISTANCE |                     |                            |                            | LATERAL THRUST      |                     |
|-------------------|------------------------|---------------------|---------------------|----------------------------|--------|--------------------------------|---------------------|---------------------|----------------------------|----------------------------|---------------------------------|---------------------|----------------------------|----------------------------|---------------------|---------------------|
| Dia-meter of pile | Under reamed dia-meter | Single under-reamed | Double under-reamed | Longitudinal Reinforcement |        | Rings spacing of 6mm dia rings | Single under-reamed | Double under-reamed | In-crease per 30 cm Length | De-crease per 30 cm Length | Single under-reamed             | Double under-reamed | In-crease per 30 cm length | De-crease per 30 cm length | Single under-reamed | Double under-reamed |
|                   |                        |                     |                     | No.                        | Dia mm |                                |                     |                     |                            |                            |                                 |                     |                            |                            |                     |                     |
| cm                | cm                     | m                   | m                   | (5)                        | (6)    | (7)                            | (8)                 | (9)                 | (10)                       | (11)                       | (12)                            | (13)                | (14)                       | (15)                       | (16)                | (17)                |
| 20                | 50                     | 3.5                 | 3.5                 | 3                          | 10     | 18                             | 8                   | 12                  | 0.9                        | 0.7                        | 4                               | 6                   | 0.65                       | 0.55                       | 1.0                 | 1.2                 |
| 25                | 62.5                   | 3.5                 | 3.5                 | 4                          | 10     | 22                             | 12                  | 18                  | 1.15                       | 0.9                        | 6                               | 9                   | 0.85                       | 0.70                       | 1.5                 | 1.8                 |
| 30                | 75                     | 3.5                 | 3.5                 | 4                          | 12     | 25                             | 16                  | 24                  | 1.4                        | 1.1                        | 8                               | 12                  | 1.05                       | 0.85                       | 2.0                 | 2.4                 |
| 37.5              | 94                     | 3.5                 | 3.75                | 5                          | 12     | 30                             | 24                  | 36                  | 1.8                        | 1.4                        | 12                              | 18                  | 1.35                       | 1.10                       | 3.0                 | 3.6                 |
| 40                | 100                    | 3.5                 | 4.0                 | 6                          | 12     | 30                             | 23                  | 42                  | 1.9                        | 1.5                        | 14                              | 21                  | 1.45                       | 1.15                       | 3.4                 | 4.0                 |
| 45                | 112.5                  | 3.5                 | 4.5                 | 7                          | 12     | 30                             | 35                  | 52.5                | 2.15                       | 1.7                        | 17.5                            | 25.75               | 1.60                       | 1.30                       | 4.0                 | 4.8                 |
| 50                | 125                    | 3.5                 | 5.0                 | 9                          | 12     | 30                             | 42                  | 63                  | 2.4                        | 1.9                        | 21                              | 31.5                | 1.80                       | 1.45                       | 4.5                 | 5.4                 |

**B-1.11** For piles subjected to external moments and or larger lateral loads than those given in Table 1, the pile should be designed properly and requisite amount of steel should be provided.

NOTE — For obtaining safe loads from Table 1, 'N' value (standard penetration test value) a weighted average should be taken up to a depth equal to the bulb diameter below the pile toe. In case of predominantly silty soils, the guiding 'N' value for obtaining safe loads may be taken between the values given for sandy and clayey soils.

## APPENDIX C

(Clause 5.2.5)

### MODULUS OF SUBGRADE

**C-1.** The values of the constant of modulus of horizontal subgrade reaction  $n_h$  in sand or the modulus of subgrade reaction,  $K$ , in clay may be taken from Tables 2 and 3.

TABLE 2 TYPICAL VALUES OF  $n_h$

| SOIL TYPE                              | $n_h$ IN $\text{kg/cm}^3$ |           |
|--|---------------------------|-----------|
|  | Dry                       | Submerged |
| Loose sand                             | 0.260                     | 0.146     |
| Medium sand                            | 0.775                     | 0.526     |
| Dense sand                             | 2.076                     | 1.245     |
| Very loose sand under repeated loading | —                         | 0.041     |

TABLE 3 TYPICAL VALUES OF  $K$  (for preloaded clay)

| UNCONFINED<br>COMPRESSIVE<br>STRENGTH<br>$\text{kg/cm}^2$ | RANGE OF<br>VALUE OF $K$<br>$\text{kg/cm}^2$ | PROBABLE<br>VALUE OF $K$<br>$\text{kg/cm}^2$ |
|---|--|--|
| 0.2 to 0.4  | 7 to 42                                      | 7.73   |
| 1 to 2  | 32 to 65                                     | 48.79  |
| 2 to 4  | 65 to 130                                    | 97.73  |
| 4   | —  | 195.46                                       |

**APPENDIX D***(Clause 6.2)***EQUIPMENT FOR UNDER-REAMED PILES  
(MANUAL CONSTRUCTION)****D-1. EQUIPMENT**

**D-1.1** Normally the following equipment will be required in manual operation:

- a) An auger;
- b) An under-reamer;
- c) A boring guide; and
- d) Accessories like spare extensions, cutting tool, concreting funnel, etc.

**D-1.1.1** For the piles of size larger than 30 cm and for larger depths additional equipment required will be a portable tripod hoist with a manually operated winch.

**D-1.1.2** For piles in high ground water table and unstable soil conditions, boring and under-reaming shall be carried out with bentonite slurry using suitable equipment. Tremie pipe shall be used for concreting.

**D-1.1.3** The additional equipment normally required for under-reamed compaction pile are the following:

- a) Drop weight for driving the core assembly, and
- b) Pipe or solid core.

**APPENDIX E***(Clause 6.4)***BASIC PROPERTIES OF DRILLING MUD (BENTONITE)****E-1. PROPERTIES**

**E-1.1** The bentonite suspension used in bore holes is basically a clay of montmorillonite group having exchangeable sodium cations. Because of the presence of medium cations, bentonite on dispersion will break down



into small plate like particles having a negative charge on the surfaces and positive charge on the edges. When the dispersion is left to stand undisturbed, the particles become oriented building up a mechanical structure of its own, the mechanical structure held by electrical bonds is observable as a jelly like mass or jell material. When the jell is agitated, the weak electrical bonds are broken and the dispersion becomes fluid.

## **E-2. FUNCTIONS**

**E-2.1** The action of bentonite in stabilizing the sides of bore holes is primarily due to the thixotropic property of bentonite suspensions. The thixotropic property of bentonite suspension permits the material to have the consistency of a fluid when introduced into the excavation and when undisturbed forms a jelly which when agitated becomes a fluid again.

**E-2.2** In the case of a granular soil, the bentonite suspension penetrates into the sides under positive pressure and after a while forms a jelly. The bentonite suspension gets deposited on the sides of the hole and makes the surface impervious and imparts a plastering effect. In impervious clay, the bentonite does not penetrate into the soil, but deposits only a thin film on the surface of the hole. Under such conditions, stability is derived from the hydro-static head of the suspension.

## **E-3. SPECIFICATION**

**E-3.1** The bentonite suspension used for piling work shall satisfy the following requirements:

- a) The liquid limit of bentonite when tested in accordance with IS: 2720 (Part V)-1965\* shall be more than 300 percent and less than 450 percent.
- b) The sand content of the bentonite powder shall not be greater than 7 percent.

**NOTE** — The purpose of limiting the sand content is mainly to control and reduce the wear and tear of the pumping equipment.

- c) Bentonite solution should be made by mixing it with fresh water using pump for circulation. The relative density of the bentonite solution should be between 1.034 and 1.10.
- d) The differential free swell shall be more than 540 percent.

---

\*Methods of test for soils: Part V Determination of liquid and plastic limits (*first revision*).

*(Continued from page 2)*

## File Foundations Subcommittee, BDC 43 : 5

| <i>Convener</i>   | <i>Representing</i>   |
|---|---|
| SHRI M. D. TAMBEKAR   | Bombay Port Trust, Bombay   |
| <i>Members</i>  |   |
| SHRI K. N. DADINA   | In personal capacity ( <i>P 820, Block P, New Alipore, Calcutta</i> )         |
| DEPUTY DIRECTOR RESEARCH<br>(SM II)                             | Ministry of Railways  |
| DEPUTY DIRECTOR STANDARDS<br>(B & S/CB II) ( <i>Alternate</i> ) |   |
| SHRI A. GHOSHAL   | Braithwaite Burn & Jessops Construction Co Ltd,<br>Calcutta                   |
| SHRI S. R. KULKARNI   | M. N. Dastur & Co Pvt Ltd, Calcutta   |
| SHRI M. R. PUNJA  | Cementation Co Ltd, Bombay  |
| SHRI S. K. SANYAL   | Metallurgical & Engineering Consultants (Steel<br>Authority of India), Bhilai |
| SHRI K. SARKAR  | Engineers India Ltd, New Delhi  |
| SHRI D. SHARMA  | Central Building Research Institute (CSIR),<br>Roorkee                        |
| DR S. P. SHRIVASTAVA  | United Technical Consultants (Pvt) Ltd, New<br>Delhi                          |
| DR R. KAPUR ( <i>Alternate</i> )                                |   |

# BUREAU OF INDIAN STANDARDS

## Headquarters:

Manak Bhavan, 9 Bahadur Shah Zafar Marg, NEW DELHI 110002

Telephones: 323 0131, 323 3375, 323 9402

Fax : 91 11 3234062, 91 11 3239399, 91 11 3239382

Telegrams : Manaksanstha  
(Common to all Offices)

## Central Laboratory:

Plot No. 20/9, Site IV, Sahibabad Industrial Area, Sahibabad 201010

Telephone

8-77 0032

## Regional Offices:

Central : Manak Bhavan, 9 Bahadur Shah Zafar Marg, NEW DELHI 110002 323 76 17

\*Eastern : 1/14 CIT Scheme VII M, V.I.P. Road, Maniktola, CALCUTTA 700054 337 86 62

Northern : SCO 335-336, Sector 34-A, CHANDIGARH 160022 60 38 43

Southern : C.I.T. Campus, IV Cross Road, CHENNAI 600113 235 23 15

† Western : Manakalaya, E9, Behind Marol Telephone Exchange, Andheri (East),  
MUMBAI 400093 832 92 95

## Branch Offices:

'Pushpak', Nurmohamed Shaikh Marg, Khanpur, AHMEDABAD 380001 550 13 48

‡ Peenya Industrial Area, 1st Stage, Bangalore-Tumkur Road,  
BANGALORE 560058 839 49 55

Gangotri Complex, 5th Floor, Bhadbhada Road, T.T. Nagar, BHOPAL 462003 55 40 21

Plot No. 62-63, Unit VI, Ganga Nagar, BHUBANESHWAR 751001 40 36 27

Kalaikathir Buildings, 670 Avinashi Road, COIMBATORE 641037 21 01 41

Plot No. 43, Sector 16 A, Mathura Road, FARIDABAD 121001 8-28 88 01

Savitri Complex, 116 G.T. Road, GHAZIABAD 201001 8-71 19 96

53/5 Ward No. 29, R.G. Barua Road, 5th By-lane, GUWAHATI 781003 54 11 37

5-8-56C, L.N. Gupta Marg, Nampally Station Road, HYDERABAD 500001 20 10 83

E-52, Chitaranjan Marg, C-Scheme, JAIPUR 302001 37 29 25

117/418 B, Sarvodaya Nagar, KANPUR 208005 21 68 76

Seth Bhawan, 2nd Floor, Behind Leela Cinema, Naval Kishore Road,  
LUCKNOW 226001 23 89 23

NIT Building, Second Floor, Gokulpat Market, NAGPUR 440010 52 51 71

Patliputra Industrial Estate, PATNA 800013 26 23 05

Institution of Engineers (India) Building 1332 Shivaji Nagar, PUNE 411005 32 36 35

T.C. No. 14/1421, University P.O. Palayam, THIRUVANANTHAPURAM 695034 6 21 17

---

\*Sales Office is at 5 Chowringhee Approach, P.O. Princep Street,  
CALCUTTA 700072 27 10 85

† Sales Office is at Novelty Chambers, Grant Road, MUMBAI 400007 309 65 28

‡ Sales Office is at 'F' Block, Unity Building, Narashimaraja Square,  
BANGALORE 560002 222 39 71

# AMENDMENT NO. 1 JANUARY 1983

TO

## IS : 2911 (Part III) - 1980 CODE OF PRACTICE FOR DESIGN AND CONSTRUCTION OF PILE FOUNDATIONS

### PART III UNDER-REAMED PILES

(First Revision)

#### Alterations

(Page 12, clause 5.2.2.1, line 9) — Substitute ' of ' for ' or '.

(Page 12, clause 5.2.3.1, line 6) — Delete the words ' and IS : 6403-1971† '.

(Page 12, foot-note with ' † ' mark ) — Delete.

[ Page 13, clause 5.2.3.1(b) ]:

a) Lines 3 and 4, value of '  $Q_u$  ' — Substitute the following for the existing matter:

$$Q_u = A_p \left( \frac{1}{2} D \cdot \gamma \cdot N_\gamma + \gamma \cdot d_f \cdot N_q \right) + A_b \left( \frac{1}{2} D_u \cdot n \cdot \gamma \cdot N_\gamma + \gamma \cdot N_q \sum_{r=1}^n d_r \right) + \frac{1}{2} \pi \cdot D \cdot \gamma \cdot K \tan \delta (d_1^2 + d_f^2 - d_n^2)$$

b) Line 9 — Substitute '  $\gamma$  ( kg/cm<sup>3</sup> ) ' for '  $\lambda$  ( kg/cm<sup>3</sup> ) '.

c) Line 10 — Substitute '  $N_\gamma$  ' for '  $N_\lambda$  '.

(Page 14, Note 3) — Substitute the following for the existing note:

'NOTE 3 —  $N_\gamma$  will be as specified in IS : 6403-1981\* and  $N_q$  will be taken from Fig. 2. This is based on Berezantsev's curve up to  $\phi = 35^\circ$  and Vesic's curves beyond  $\phi = 35^\circ$ .'

[ Page 14, clause 5.2.3.1 (d), line 7 ] — Substitute '  $N_\gamma$  ' for '  $N_\lambda$  '.

(Page 14, foot-note with ' \* ' mark ) — Substitute the following for the existing foot-note:

'\*Code of practice for determination of bearing capacity of shallow foundations (first revision).'

( Page 15, Fig. 2 ) — Substitute the following for the existing figure:

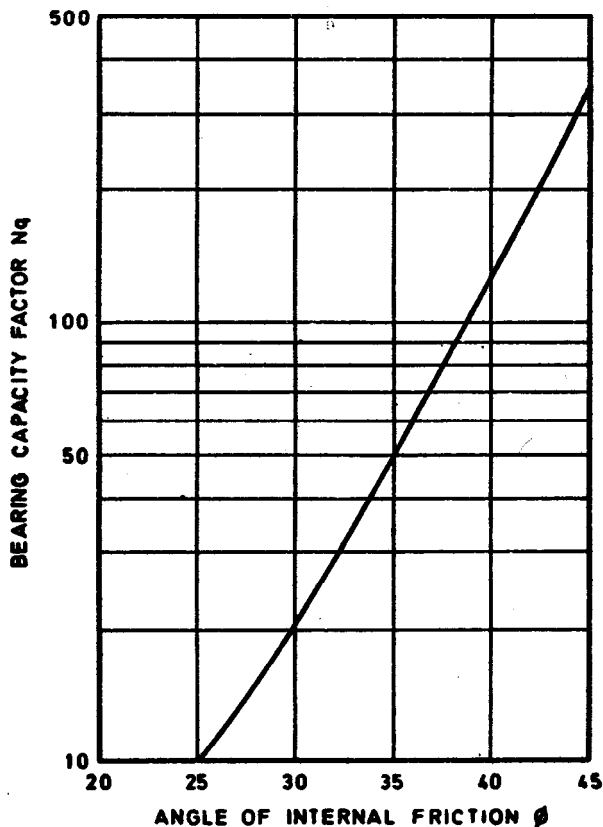

FIG. 2 BEARING CAPACITY FACTOR  $N_q$

( Page 32, clause E-3.1, line 4 ) — Substitute 'IS : 2720( Part V)-1970\*' for 'IS : 2720( Part V )-1965\*'

( BDC 49 )

TO

IS:2911(Part 3)-1980 CODE OF PRACTICE FOR DESIGN  
AND CONSTRUCTION OF PILE FOUNDATIONS

PART 3 UNDER-REAMED PILES

*(First Revision)*

Alterations

*(Page 8, clause 4.2, line 1)* - Substitute  
'IS:432(Part 1)-1982\*' for 'IS:432(Part 1)-1966\*'.  
'

*(Page 8, foot-note with '\*' mark)* - Substitute  
the following for the existing foot-note:

'\*Specification for mild steel and medium tensile  
steel bars and hard drawn steel bars and hard drawn  
steel wire for concrete reinforcement: Part 1 Mild  
steel and medium tensile steel bars (*third revision*).  
'

*(Page 11, clause 5.2.2.1, first sentence)* -  
Substitute the following for the existing sentence:

'The minimum area of longitudinal reinforcement (any  
type or grade) within the pile shaft shall be 0.4  
percent of the sectional area calculated on the  
basis of outside area of the shaft or casing if  
used.'  
'

*(Page 21, clause 5.4.2 and 5.4.3)* - Delete.

*(Page 21, clause 5.4.7)* - Substitute '50 mm'  
for '40 mm'.

## Addenda

(Page 6, clause 2.19, line 2) - Add the following words after the word 'Shear within the bracket' as 'evidenced from the load settelement curves'.

(Page 9, clause 5.1) - Add the following in the end:

'and shall be designed according to IS:456-1978 Code of practice for plain and reinforced concrete (*third revision*).'

(Page 14, clause 5.2.3(c) - Add the following in the end:

! [see IS:2911(Part 4)-1979<sup>†</sup>.] '.

(BDC 43)

# AMENDMENT NO. 3 JULY 1987

TO

## IS : 2911 ( Part 3 )-1980 CODE OF PRACTICE FOR DESIGN AND CONSTRUCTION OF PILE FOUNDATIONS

### PART 3 UNDER-REAMED PILES

( *First Revision* )

( *Page 8, clause 4.3.4* ) — Substitute the following for the existing clause:

'4.3.4 The minimum grade of concrete to be used for piling shall be M-20 and the minimum cement content shall be 400 kg/m<sup>3</sup> in all conditions. For piles up to 6 m deep M-15 concrete with minimum cement content 350 kg/m<sup>3</sup> without provision for under-water concreting may be used under favourable non-aggressive subsoil condition and where concrete of higher strength is not needed structurally or due to aggressive site conditions. The concrete in aggressive surroundings due to presence of sulphates, etc, shall conform to provision given in IS : 456-1978||.

For the concrete, water and aggregates specifications laid down in IS : 456-1978|| shall be followed in general. Natural rounded shingle of appropriate size may also be used as coarse aggregate. It helps to give high slump with less water-cement ratio. For tremie concreting aggregates having nominal size more than 20 mm should not be used.'

( *Page 9, clauses 4.3.6.1 and 4.3.6.2* ) — Substitute the following for the existing clauses:

'4.3.6 The average compressive stress under working load should not exceed 25 percent of the specified strength at 28 days calculated on the total cross-sectional area of the pile. If in the portion of the shaft above the top under-reamed a permanent casing of adequate thickness and of suitable size is used, the allowable stress may be suitably increased.'

[ *Page 14, clauses 5.2.3.1(c) and 5.2.3.2 ( see also Amendment No. 2 )* ] — Substitute 'IS : 2911 ( Part 4 )-1984†' for 'IS : 2911 ( Part 4 )-1979†'.

( *Page 14, foot-note with '†' mark* ) — Substitute the following for the existing foot-note:

†Code of practice for design and construction of pile foundations: Part 4 Load test on piles (*first revision* ).'

[ *Page 16, clause 5.2.3.5(b), last sentence* ] — Delete.

( *Page 16, foot-note with '†' mark* ) — Delete.



( Page 17, clause 5.2.5, second para and Note ) — Substitute the following for the existing matter:

‘A recommended method for the determination of depth of fixity, lateral deflection and maximum bending moment required for design is given in Appendix C for fully or partially embedded piles. Other accepted methods, such as the method of Reese and Matlock for fully embedded piles may also be used. Due to the presence of bulbs, under-reamed piles tend to behave more as rigid piles and the analysis can be done on rigid pile basis. For lateral loads with or without axial loads, up to those given in Table 1 of Appendix C, no analysis may be necessary if external moment is not acting.

NOTE — Because of limited information on horizontal modulus of soil and refinements in the theoretical analysis, it is suggested that the adequacy of a design should be checked by an actual field load test.’

( Page 23, clause 7.3 ):

a) ( Lines 7 and 11 ) — Substitute ‘sixth’ for ‘quarter’.

b) ( Line 13 ) — Add the following matter after the word ‘depths’: ‘( below ground level ) or high ( above ground level )’.

( Page 26, clause A-1, column heading of informal table ) — Substitute ‘Free swell, percent’ for ‘Differential free swell, percent’.

( Page 30, Appendix C ) — Substitute the following for the existing Appendix including Fig. 4 and 5:

## ‘A P P E N D I X C

( Clause 5.2.5 )

### DETERMINATION OF DEPTH OF FIXITY, LATERAL DEFLECTION AND MAXIMUM MOMENT OF LATERALLY LOADED PILES

#### C-1. DETERMINATION OF LATERAL DEFLECTION AT THE PILE HEAD AND DEPTH OF FIXITY

C-1.1 The long flexible pile, fully or partially embedded, is treated as a cantilever fixed at some depth below the ground level ( see Fig. 4 ).

C-1.2 Determine the depth of fixity and hence the equivalent length of the cantilever using the plots given in Fig. 4.

where  $T=5 \sqrt{\frac{EI}{K_1}}$  and  $R=4 \sqrt{\frac{EI}{K_2}}$  (  $K_1$  and  $K_2$  are constants given

in Tables 2 and 3 below,  $E$  is Young's modulus of the pile material in  $\text{kg/cm}^2$  and  $I$  is the moment of inertia of the pile cross-section in  $\text{cm}^4$ ).

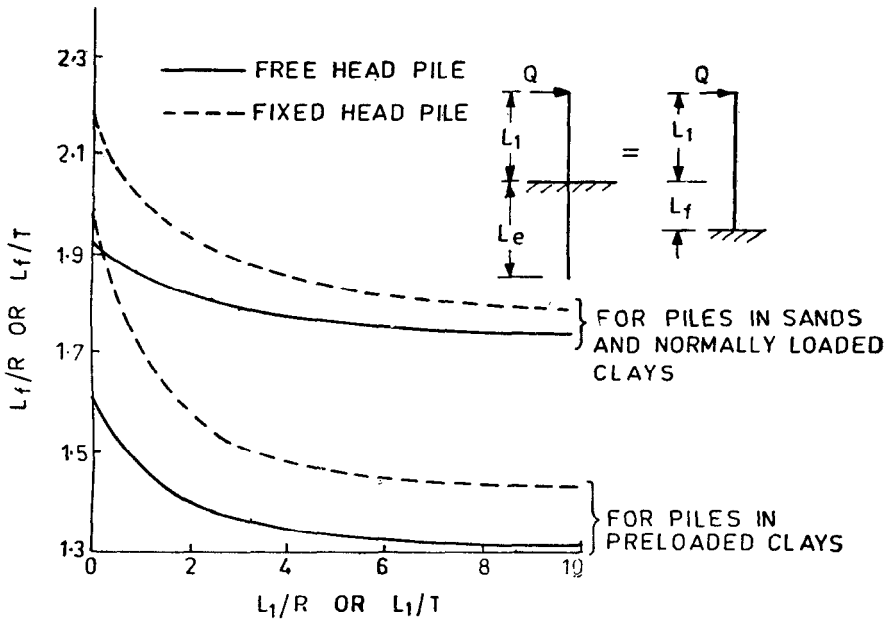
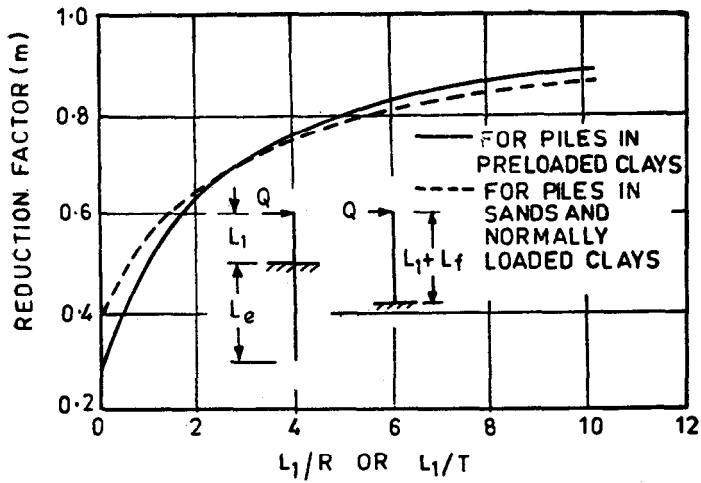

FIG. 4 DETERMINATION OF DEPTH FIXITY

NOTE — Figure 5 is valid for long flexible piles where the embedded length,  $L_e$  is  $\geq 4R$  or  $4T$ .

TABLE 2 VALUES OF CONSTANT  $K_1$  ( $\text{kg/cm}^3$ )

| TYPE OF SOIL   | VALUE |           |
|--|-------|-----------|
|  | Dry   | Submerged |
| (1)  | (2)   | (3)       |
| Loose sand   | 0.260 | 0.146     |
| Medium sand  | 0.775 | 0.525     |
| Dense sand   | 2.075 | 1.245     |
| Very loose sand under repeated loading or normally loading clays | —     | 0.040     |



5A FOR FREE HEAD PILE

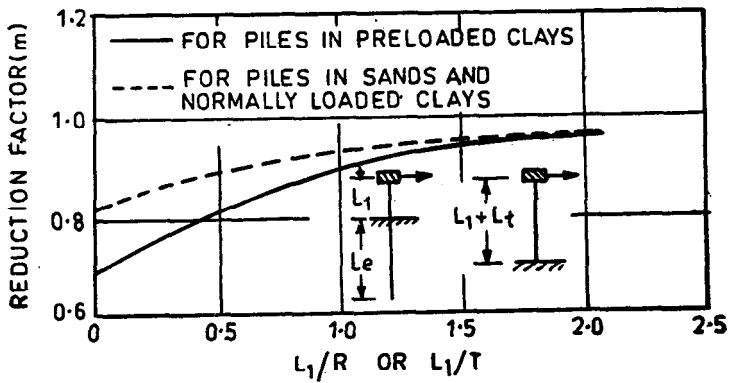

5B FOR FIXED HEAD PILE

FIG. 5 DETERMINATION OF REDUCTION FACTORS FOR COMPUTATION OF MAXIMUM MOMENT IN PILE

| TABLE 3 VALUES OF CONSTANT $K_2$ ( kg/cm <sup>3</sup> ) |        |
|---|--------|
| UNCONFINED COMPRESSIVE STRENGTH<br>kg/cm <sup>2</sup>   | VALUE  |
| (1)   | (2)    |
| 0.2 to 0.4  | 7.75   |
| 1 to 2  | 48.80  |
| 2 to 4  | 97.75  |
| More than 4   | 195.50 |

**C-1.3** Knowing the length of the equivalent cantilever the pile head deflection ( $Y$ ) shall be computed using the following equations:

$$Y \text{ (cm)} = \frac{Q(L_1 + L_F)^3}{3EI} \quad \dots \text{for free head pile}$$

$$= \frac{Q(L_1 + L_F)^3}{12EI} \quad \dots \text{for fixed head pile}$$

where  $Q$  is the lateral load in kg.

## **C-2. DETERMINATION OF MAXIMUM MOMENT IN THE PILE**

**C-2.1** The fixed end moment ( $M_F$ ) of the equivalent cantilever is higher than the actual maximum moment ( $M$ ) of the pile. The actual maximum moment is obtained by multiplying the fixed end moment of the equivalent cantilever by a reduction factor,  $m$  given in Fig. 5. The fixed end moment of the equivalent cantilever is given by:

$$M_F = Q(L_1 + L_f) \quad \dots \text{for free head pile}$$

$$= \frac{Q(L_1 + L_f)}{2} \quad \dots \text{for fixed head pile}$$

The actual maximum moment ( $M$ ) =  $m(M_F)$ .