

IS : 2386 (Part VII) - 1963

Indian Standard

METHODS OF
TEST FOR AGGREGATES FOR CONCRETE
PART VII ALKALI AGGREGATE REACTIVITY

(First Reprint JUNE 1973)

UDC 691.322 : 620.193



© Copyright 1963

INDIAN STANDARDS INSTITUTION
MANAK BHAVAN, 9 BAHADUR SHAH ZAFAR MARG
NEW DELHI 1

Price Rs 8.50

December 1963

Indian Standard

METHODS OF TEST FOR AGGREGATES FOR CONCRETE PART VII ALKALI AGGREGATE REACTIVITY

Cement and Concrete Sectional Committee, BDC 2

Chairman

SHRI K. K. NAMBIAR

Representing

The Concrete Association of India, Bombay

Members

SHRI K. V. THADANEY (*Alternate to*
Shri K. K. Nambiar)

SHRI K. F. ANTIA

SHRI P. S. BHATNAGAR

DR I. C. DOS M. PAIS CUDDOU

M. N. Dastur & Co Private Ltd, Calcutta

Bhakra Dam Designs Directorate, New Delhi

Central Water & Power Commission (Ministry of Irrigation
& Power)

SHRI Y. K. MURTHY (*Alternate*)

SHRI N. D. DAFTARY

SHRI N. G. DEWAN

SUPERINTENDING ENGINEER, 2ND CIRCLE

DR R. R. HATTIANGADI

SHRI V. N. PAI (*Alternate*)

SHRI P. C. HAZRA

JOINT DIRECTOR STANDARDS (B & S)

Khira Steel Works Private Ltd, Bombay

Central Public Works Department

(*Alternate*)

The Associated Cement Companies Ltd, Bombay

Geological Survey of India, Calcutta

Research, Designs & Standards Organization (Ministry of
Railways)

ASSISTANT DIRECTOR STANDARDS (B & S) (*Alternate*)

SHRI S. B. JOSHI

SHRI M. M. LAL

SHRI B. N. MAJUMDAR

S. B. Joshi & Co Private Ltd, Bombay

U. P. Government Cement Factory, Churk

Directorate General of Supplies & Disposals (Ministry of
Economic & Defence Co-ordination)

SHRI P. L. DAS (*Alternate*)

PROF S. R. MEHRA

SHRI N. H. MOHILE

SHRI S. N. MUKERJI

SHRI N. C. SEN GUPTA (*Alternate*)

SHRI ERACH A. NADIRSHAH

SHRI C. B. PATEL

Central Road Research Institute (CSIR), New Delhi

The Concrete Association of India, Bombay

Government Test House, Calcutta

Institution of Engineers (India), Calcutta

National Buildings Organisation (Ministry of Works, Housing
& Rehabilitation)

SHRI RABINDER SINGH (*Alternate*)

PROF G. S. RAMASWAMY

SHRI K. SIVA PRASAD (*Alternate*)

SHRI T. N. S. RAO

SHRI S. R. PINHEIRO (*Alternate*)

Central Building Research Institute (CSIR), Roorkee

Gammon India Ltd, Bombay

(Continued on page 2)

(Continued from page 1)

Members

REPRESENTATIVE

SHRI NIHAR CHANDRA ROY
SECRETARY

BRIG G. S. SIHOTA

SHRI R. S. MEHANDRU (*Alternate*)

DR BH. SUBBARAJU

SHRI J. M. TREHAN

SHRI N. H. KESWANI (*Alternate*)

DR. H. C. VIVESVARAYA,

Deputy Director (Bldg)

Representing

Martin Burn Ltd, Calcutta

Dalmia Cement (Bharat) Ltd, Calcutta

Central Board of Irrigation & Power (Ministry of Irrigation & Power)

Engineer-in-Chief's Branch, Army Headquarters

Indian Roads Congress, New Delhi

Roads Wing, Ministry of Transport & Communications

Director, ISI (*Ex-officio Member*)

Secretary

SHRI A. PRITHIVI RAJ

Extra Assistant Director (Bldg), ISI

Concrete Subcommittee, BDC 2 : 2

Convener

SHRI S. B. JOSHI

S. B. Joshi & Co Private Ltd, Bombay

Members

ASSISTANT DIRECTOR STANDARDS (B & S)

Research, Designs & Standards Organization (Ministry of Railways)

SHRI N. H. BHAGWANANI

Engineer-in-Chief's Branch, Army Headquarters

DR I. C. DOS M. PAIS CUDDOU

Central Water & Power Commission (Ministry of Irrigation & Power)

SHRI Y. K. MURTHY (*Alternate*)

SHRI P. L. DAS

Directorate General of Supplies & Disposals (Ministry of Economic & Defence Co-ordination)

SHRI B. N. MAJUMDAR (*Alternate*)

DIRECTOR

Engineering Research Laboratory, Hyderabad

SHRI V. N. GUNAJI

Maharashtra Public Works Department

SHRI M. A. HAFEEZ

National Buildings Organisation (Ministry of Works, Housing & Rehabilitation)

SHRI B. S. SHIVAMURTHY (*Alternate*)

SHRI C. L. HANDA

Central Water & Power Commission (Ministry of Irrigation & Power)

SHRI P. C. HAZRA

Geological Survey of India, Calcutta

SHRI K. K. NAMBIAR

The Concrete Association of India, Bombay

SHRI C. L. N. IVENGAR (*Alternate*)

DR M. L. PURI

Central Road Research Institute (CSIR), New Delhi

PROF G. S. RAMASWAMY

Central Building Research Institute (CSIR), Roorkee

SHRI K. SIVA PRASAD (*Alternate*)

SHRI T. N. S. RAO

Gammon India Ltd, Bombay

SHRI S. R. PINHEIRO (*Alternate*)

SUPERINTENDING ENGINEER, 2ND CIRCLE

Central Public Works Department

SHRI O. P. GOEL (*Alternate*)

SHRI J. M. TREHAN

Roads Wing, Ministry of Transport & Communications

SHRI R. P. SIKKA (*Alternate*)

SHRI H. T. YAN

Braithwaite Burn & Jessop Construction Co Ltd, Calcutta

Indian Standard

METHODS OF TEST FOR AGGREGATES FOR CONCRETE PART VII ALKALI AGGREGATE REACTIVITY

0. FOREWORD

0.1 This Indian Standard (Part VII) was adopted by the Indian Standards Institution on 24 September 1963, after the draft finalized by the Cement and Concrete Sectional Committee had been approved by the Building Division Council.

0.2 One of the major contributing factors to the quality of concrete is the quality of aggregates used therein. The test methods given in this standard are intended to assist in assessing the quality of aggregates. In a given situation, for a particular aggregate, it may not be necessary to assess all the qualities, and, therefore, it is necessary to determine beforehand the purpose for which a concrete is being used and the qualities of the aggregate which require to be assessed. Accordingly, the relevant test methods may be chosen from amongst the various tests covered in this standard. For the convenience of the users, the test methods are grouped into the following eight parts of Indian Standard Methods of Test for Aggregates for Concrete (IS : 2386-1963).

- Part I Particle Size and Shape
- Part II Estimation of Deleterious Materials and Organic Impurities
- Part III Specific Gravity, Density, Voids Absorption and Bulking
- Part IV Mechanical Properties
- Part V Soundness
- Part VI Measuring Mortar Making Properties of Fine Aggregate
- Part VII Alkali Aggregate Reactivity
- Part VIII Petrographic Examination

0.3 The Sectional Committee responsible for the preparation of this standard has taken into consideration the views of concrete specialists, testing authorities, consumers and technologists and has related the standard to the practices followed in this country. Further, the need for international co-ordination among standards prevailing in different countries of the world has also been recognized. These considerations led the Sectional Committee

to derive assistance from the published standards and publications of the American Society for Testing and Materials.

0.4 Wherever a reference to any Indian Standard appears in these methods, it shall be taken as a reference to its latest version.

0.5 For the purpose of deciding whether a particular requirement of this standard is complied with, the final value, observed or calculated, expressing the result of a test or analysis, shall be rounded off in accordance with IS : 2-1960 Rules for Rounding Off Numerical Values (*Revised*). The number of significant places retained in the rounded off value should be the same as that of the specified value in this standard.

0.6 This standard is intended chiefly to cover the technical provisions relating to testing of aggregates for concrete, and it does not include all the necessary provisions of a contract.

1. SCOPE

1.1 This standard (Part VII) covers the following two methods of test for determining the potential reactivity of aggregates:

- a) Determination of Potential Alkali Reactivity of Cement-Aggregate Combinations (Mortar Bar Method);
- b) Determination of Potential Reactivity of Aggregates (Chemical Method).

2. DETERMINATION OF POTENTIAL ALKALI REACTIVITY OF CEMENT-AGGREGATE COMBINATIONS (MORTAR BAR METHOD)

2.1 Object — This method of test covers the determination of the potential expansive Alkali reactivity of cement-aggregate combinations by measuring the expansion developed by the combinations in mortar bars during storage under prescribed conditions of test.

2.2 Apparatus — The apparatus shall consist of the following:

- a) *Scales* — The scales used in weighing materials for mortar mixtures shall conform to the following requirements:

On scales in use, the permissible variation at a load of 2 000 g shall be ± 2.0 g. The permissible variation on new scales shall be one half of this value. The sensibility reciprocal shall be not greater than twice the permissible variation.

- b) *Weights* — The permissible variations on weights used in weighing materials for mortar mixtures shall be as in Table I. The permissible

variations on new weights shall be one half of the values given in Table I.

TABLE I PERMISSIBLE VARIATIONS ON WEIGHTS

WEIGHT	PERMISSIBLE VARIATIONS ON WEIGHTS IN USE, PLUS OR MINUS
g	g
1 000	0.50
900	0.45
750	0.40
500	0.35
300	0.30
250	0.25
200	0.20
100	0.15
50	0.10
20	0.05
10	0.04
5	0.03
2	0.02
1	0.01

- c) *Sieves* — Square-hole, woven wire cloth sieves conforming to IS : 460-1962 Specification for Test Sieves (*Revised*).
- d) *Glass Graduates* — Glass graduates of 200 ml capacity used for measuring the mixing water shall be calibrated at 20°C with a permissible variation of ± 2 ml. These graduates shall be subdivided to at least 5 ml. The main graduation lines shall be circles and shall be numbered. The least graduations shall extend at least one-seventh of the way around, and intermediate graduations shall extend at least one-fifth of the way around. The graduation lines may be omitted for the lowest 10 ml.
- e) *Specimen Moulds* — Moulds may be either single or double (*see* Fig. 1 and 2). The single mould is preferred. Moulds shall provide for 25 × 25 mm test specimens of 250 mm effective gauge length. The effective gauge length shall be considered as that length between the innermost points of the gauge studs. The parts of the moulds shall be tight-fitting and firmly held together when assembled. The moulds shall be made of steel or other hard metal not readily attacked by the cement paste. The sides of the moulds shall be sufficiently rigid to prevent spreading or warping. Each end plate of the moulds shall be equipped to hold properly in place, during the setting period, a metal gauge stud (*see* Fig. 1 and 2) having a diameter of 6.3 mm (*see* Note). The gauge studs shall be

set so that their principal axes coincide with the principal axis of the test specimen, and shall extend into the specimen 15.0 ± 0.5 mm. The distance between the inner ends of the gauge studs shall be 250 ± 2.5 mm. The width and height of the moulds, measured separately for each specimen compartment, shall be 25 ± 0.75 mm both for new moulds and for moulds in use.

NOTE — Stainless steel gauge studs of some compositions have corroded under the conditions of use required in this test method.

- f) *Mixing Bowl* — The mixing bowl shall be of stainless steel. It shall have a capacity of 5 to 8 litres and shall conform in shape and dimensions to Fig. 3.
- g) *Tamper* — The tamper shall be made of a non-absorptive, non-abrasive material, such as medium-hard rubber or seasoned oak wood rendered non-absorptive by immersion for 15 min in paraffin at approximately 200°C , and shall have a cross section of 12.5×25 mm and a convenient length (125 or 150 mm). The tamping face of the tamper shall be flat and at right angles to the length of the tamper.
- h) *Trowel* — The trowel shall have a steel blade 100 to 150 mm in length, with straight-edges.
- j) *Containers* — Covered containers for storing the test specimens shall be constructed of material, that is, resistant to corrosion under the conditions of use. They shall be so constructed that, when used for storing specimens, the loss of moisture is prevented by tight-fitting covers or by sealing, or by both. Provisions shall be made for supporting the bars in a vertical position with the lower end of the bar approximately 25 mm above the surface of water in the container. The weight of the specimen shall not be supported on the metal gauge stud. Spacers shall be provided to insure that the specimens do not touch the sides of the containers or each other. Provisions shall be made to prevent water splashing and condensate dripping onto the specimens.
- k) *Length Comparator* — The comparator for measuring the length change shall be of such design as to provide or permit the following characteristics (see Note 1):
 - 1) A positive means of contact with the stud that will insure reproducible measurements of length.
 - 2) A high-grade dial micrometer or other measuring device graduated to read in 0.002 mm units, and accurate within 0.002 mm in any 0.02 mm range, and within 0.004 mm in any 0.25 mm range (see Note 2).
 - 3) Sufficient range in the measuring device to allow for small variations in the gauge length of various specimens (see Note 3).

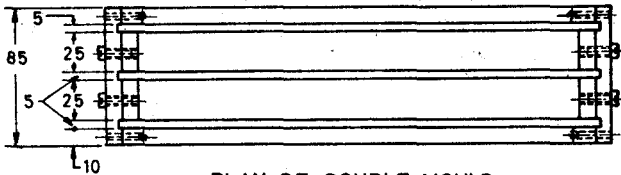

PLAN OF DOUBLE MOULD

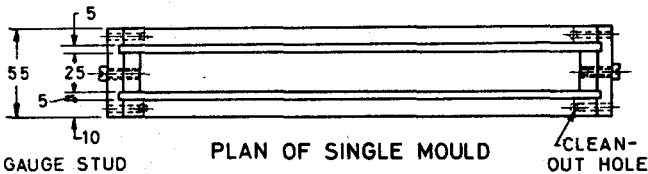

PLAN OF SINGLE MOULD

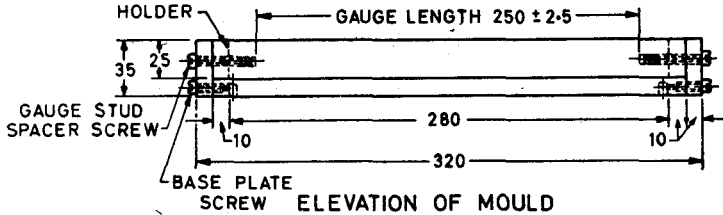

SCREW ELEVATION OF MOULD

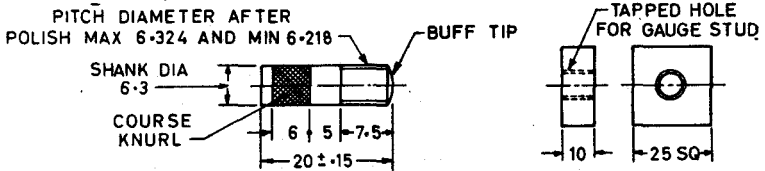

ENLARGED DETAIL OF GAUGE STUD

GAUGE STUD HOLDER

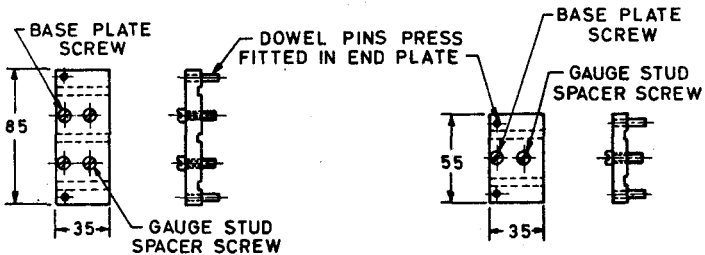

DOUBLE MOULD END PLATE

SINGLE MOULD END PLATE

All dimensions in millimetres.

FIG. 1 MOULDS USING KNURLED AND THREADED GAUGE STUDS

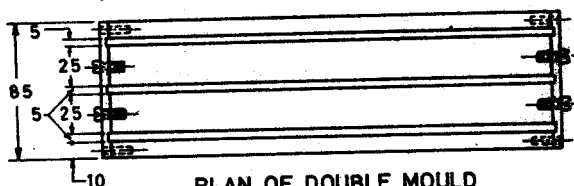

PLAN OF DOUBLE MOULD

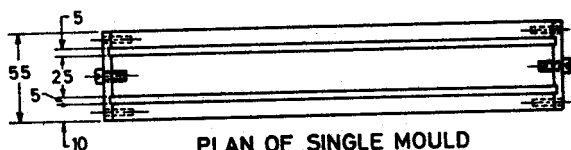

PLAN OF SINGLE MOULD

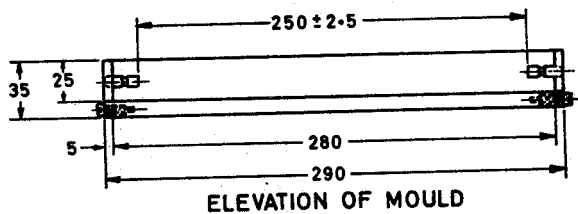

ELEVATION OF MOULD

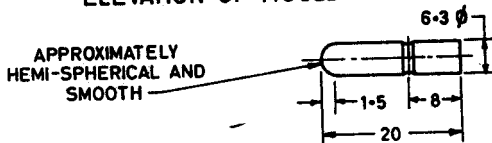

ENLARGED DETAIL OF GAUGE STUD

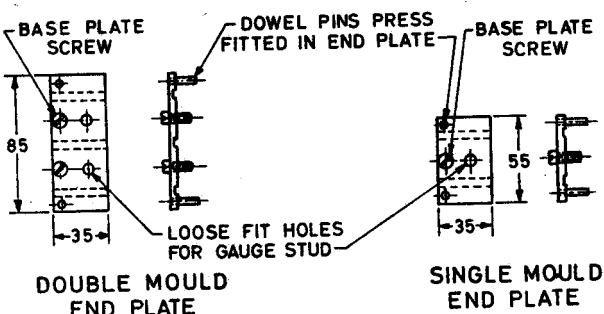

DOUBLE MOULD
END PLATE

SINGLE MOULD
END PLATE

NOTE 1 — Tolerances on 25 mm cross-sectional dimensions of the moulds shall be ± 0.75 mm.
 NOTE 2 — Gauge studs shall penetrate specimens not less than 15.0 mm or more than 16.5 mm.

All dimensions in millimetres.

FIG. 2 MOULDS USING SMOOTH GAUGE STUDS

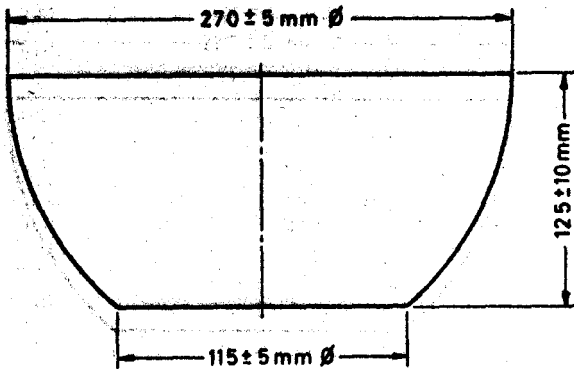

FIG. 3 MIXING BOWL

- 4) Means for checking the measuring device at regular intervals against a standard of reference (see Notes 4 and 5).
- 5) Convenient and rapid measurement of specimens.

NOTE 1 — Sketch of one type of instrument that has been found satisfactory is shown in Fig. 4. In this instrument, the contact surfaces are provided by slightly rounded (convex) machined and polished ends on the gauge studs in the specimen, and by plane, polished surface heat-treated terminals of the instrument. The terminals shall be fitted with collars 10 mm to 12.5 mm long and having an inside diameter 0.5 mm greater than the average diameter of the portion of the gauge studs that must fit into the collars. The collars shall be held in place with a set screw.

NOTE 2 — It is recommended that the micrometer or other measuring device be calibrated throughout its range to determine both the periodic and the cumulative errors, so that proper corrections can be applied to the observed data.

NOTE 3 — If the gauge studs are set carefully to position, a dial micrometer with a travel of not less than 7.5 mm provides ample range in the instrument.

NOTE 4 — The bar that serves as a reference for the dial gauge setting shall have an over-all length of 290 ± 1.5 mm. The bar shall be of alloy steel having a coefficient of thermal expansion not greater than 2 millimicrons per millimetre per degree centigrade. Each end should be machined to the same shape as the contact end of a gauge stud, and should be heat-treated and hardened, and then polished. The central 100 mm of the length of the standard bar should be covered by a rubber tube with a wall at least 3 mm thick, to minimize the effect of temperature change during handling. The standard bar should be provided near one end with a positioning mark, and should be placed in the instrument in the same position each time a length measurement is taken.

NOTE 5 — The dial gauge setting of the measuring device should be checked, by use of the reference bar, at least at the beginning and end of the readings made within a half day.

- m) Flow table conforming to the requirements specified in 12.2.2 of *IS: 1727-1960 Methods of Test for Pozzolan Materials.

*Since revised.

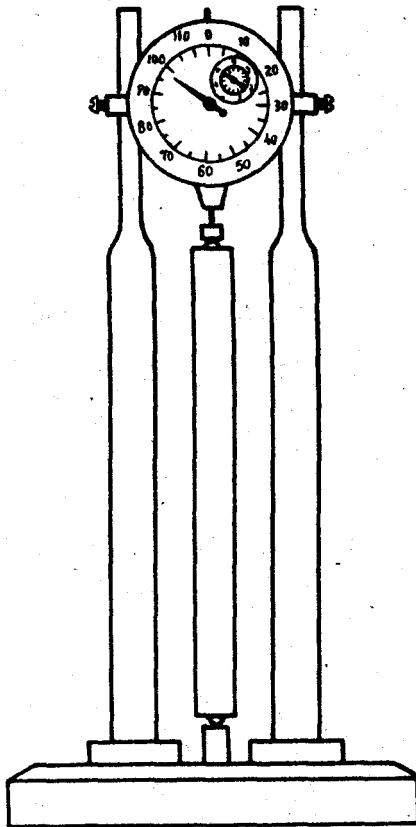

FIG. 4 ILLUSTRATIVE SKETCH OF LENGTH COMPARATOR

2.3 Temperature and Humidity

2.3.1 The temperature of the moulding room and dry materials shall be maintained at not less than 20°C and not more than 30°C. The temperature of the mixing water, of the moist closet or moist room, and of the room in which the measurements are made shall not vary from 27°C by more than 2 deg C.

2.3.2 The relative humidity of the laboratory shall be not less than 50 percent. The moist closet or moist room shall be so constructed as to provide storage facilities for test specimens at a relative humidity of not less than 90 percent.

2.3.3 The storage room in which the specimens in containers are stored shall be maintained at a temperature that shall not vary from 38°C by more than 2 deg C.

2.4 Selection and Preparation of Materials

2.4.1 Selection of Aggregate — Materials proposed for use as fine aggregate in concrete shall be processed as described in 2.4.2 with a minimum of crushing. Materials proposed for use as coarse aggregate in concrete shall be processed by crushing to produce as nearly as practicable a graded product from which a sample can be obtained. The sample shall have the grading as prescribed in 2.4.2 and be representative of the composition of the coarse aggregate as proposed for use.

NOTE 1 — When a given quarried material is proposed for use, both as coarse and as fine aggregate, it will be tested only by selection of an appropriate sample crushed to the fine aggregate sizes, unless there is reason to expect that the coarser size fractions have a different composition than the finer sizes and that these differences might significantly affect expansion due to reaction with the alkalis in cement. In this case the coarser size fractions should be tested in a manner similar to that employed in testing the fine aggregate sizes.

NOTE 2 — Coarse aggregate crushed to sand size may give accentuated expansion owing to the increased surface exposed upon crushing. Therefore, if coarse aggregate tested by this method produces an excessive amount of expansion, the material shall not be classed as objectionably reactive with alkali unless tests of concrete specimens confirm the findings of the tests of the mortar.

2.4.2 Preparation of Aggregate — Fine aggregate shall be tested in a grading meeting the requirements of the specifications for the project. Fine aggregates being tested for reasons other than to determine compliance with individual specifications, and all coarse aggregates to which this method of test is applied shall be graded in accordance with the requirements prescribed in Table II. Aggregates in which sufficient quantities of the sizes specified in Table II do not exist shall be crushed until the required material has been produced. In the case of aggregates containing insufficient amount of one or more of the larger sizes listed in Table II and if no larger material is available for crushing, the first size in which sufficient material is available shall contain the cumulative percentage of material down to that size as determined from the grading specified in Table II. When such procedures are required, special note shall be made thereof in the test report. After the aggregate has been separated into the various sizes, each size shall be washed with a water spray over the sieve to remove adhering dust and fine particles from the aggregate. The portions retained on the various sieves shall be dried and then recombined in the quantity required for one batch of mortar to the grading prescribed in Table II.

2.4.3 Selection of Cement — Cement (*see* Note 1) for use in this method shall meet the requirements of the specifications for the project and shall be from the source or sources which will or are expected to supply the cement to be used on the project. Cement for use in tests made for reasons other than to determine compliance of cement-aggregate combinations with individual specifications shall conform to the requirements of *IS : 269-1958 Specification for Ordinary, Rapid-Hardening and Low Heat Portland Cement

(Revised) (see Note 2). Cement for use in this method of test shall be passed through a 850-micron IS Sieve to remove lumps before use.

NOTE 1 — If several cements are to be used or may be used in the work, it is recommended that each of these cements be tested in combination with each of the proposed aggregates. In any event, the cement or cements whose alkali content exceeds 0.60 percent, expressed as equivalents of sodium oxide (Na_2O) content in percentage plus 0.658 time the potassium oxide (K_2O) content in percentage shall be included.

NOTE 2 — It is recommended that each aggregate subjected to this test be used with both high- and low-alkali Portland cements; other combinations, for example, with pozzolana, may be used if required. A low-alkali Portland cement is one containing not more than 0.60 percent alkalis. Cements of alkali contents as low and as high as can be obtained should be used.

TABLE II GRADING REQUIREMENTS

(Clause 2.4.2)

SIEVE SIZE		PERCENTAGE BY WEIGHT
Passing	Retained on	
4.75 mm	2.36 mm	10
2.36 mm	1.10 mm	25
1.18 mm	600 μ m	25
600 microns	300 microns	25
300 microns	150 microns	15

2.5 Preparation of Test Specimens

2.5.1 Number of Specimens — Make at least four test specimens, two from each of two batches, for each cement-aggregate combination.

2.5.2 Preparation of Moulds — Thinly cover the moulds with mineral oil; after this operation, set the gauge studs, taking care to keep them clean and free of oil. Apply a mixture of three parts of paraffin to five parts of rosin by weight, heated between 110 and 120°C, to the outside contact lines of the moulds to make the moulds watertight.

2.5.3 Proportioning of Mortar — Proportion the dry materials for the test mortar using 1 part of cement to 2.25 parts of graded aggregate by weight. The quantities of dry materials to be mixed at one time in the batch of mortar for making two specimens shall be 300 g of cement and 675 g of aggregate. Use an amount of mixing water, measured in millilitres, such as to produce a flow of 105 to 120 as determined in accordance with 12.5.2.1 of *IS : 1727-1960 Methods of Test for Pozzolanic Materials, except that the flow table shall be given 12.5-mm drops in approximately 6 seconds instead of twenty-five 12.5-mm drops in 15 seconds, and shall be expressed as a percentage by weight of the cement.

2.5.4 Mixing of Mortar — Mix the mortar in the bowl by vigorous and continuous squeezing and kneading with one hand protected by a snug-fitting

*Since revised.

rubber glove. Introduce the materials for a batch into the bowl in the following sequence:

- a) Place the water in dry bowl,
- b) Add the cement to the water and mix for 30 seconds,
- c) Add approximately one half of the aggregate and mix for 30 seconds, and
- d) Add the remainder of the aggregate and mix for $1\frac{1}{2}$ minutes.

2.5.5 Moulding Test Specimens — Immediately following the mixing, fill the mould in two layers, each layer being compacted with the tamper. Work the mortar into the corners, around the gauge studs, and along the surfaces of the mould with the tamper until a homogeneous specimen is obtained. After the top layer has been compacted, cut off the mortar flush with the top of the mould and smooth the surface with a few strokes of the trowel. Bars for expansion test specimens shall not be made of material that has previously been used for the flow test.

2.5.6 Sequence of Making Batches of Mortar — When more than one cement-aggregate combination is to be tested as part of a single investigation, make the total number of batches of mortar (2 per cement-aggregate combination) in random order, except that in no case shall the two batches representing a single cement-aggregate combination be made consecutively. When the making of all of the specimens for a single investigation requires that batches be made on two working days, each cement-aggregate combination shall be represented by one batch made on each day, and the order in which the combinations are represented by batches shall be different on the two days. When more than two days are required, one cement-aggregate combination shall be represented by a batch made on each of the working days.

2.6 Storage and Measurement of Test Specimens

2.6.1 Initial Storage — After the mould has been filled, immediately place it in the moist closet or moist room. Leave the specimens in the moulds in the moist closet or moist room for 24 ± 2 h.

2.6.2 Subsequent Storage and Measurement — After 24 ± 2 h of moulding, remove the test specimens from the moulds and measure the length; protect the specimens against loss of moisture prior to the reading for initial length. Always place the specimens in the comparator with the same end uppermost. The temperature of the specimens at the time of initial measurement shall be $27 \pm 2^\circ\text{C}$. After measuring, place the specimens on end in a metal or plastic container maintained at $38 \pm 2^\circ\text{C}$. All bars, which are placed in a given container after the initial reading at 24 ± 2 h, should be made on the same day and placed in the container in a single operation. Do not place any other specimens in the container until specimens previously stored are a minimum of 28-days old. Keep the specimens in

the container over, but not in contact with, water. When length measurements are to be made at subsequent periods, remove the container holding the specimens from the $38 \pm 2^\circ\text{C}$ storage and place in a room at a temperature of $27 \pm 2^\circ\text{C}$ for at least 16 hr prior to measuring the specimens. When measurements are made, the specimens, comparator, and reference bar shall be at the temperature of $27 \pm 2^\circ\text{C}$. Each time length measurements are made, clean the container and change the water. After measurement, replace the specimens in the container, in inverted position as compared with the previous storage period, and return the container to the $27 \pm 2^\circ\text{C}$ temperature storage.

2.7 Calculation — Measure the specimens for length periodically. Readings at ages of 1, 2, 3, 6, 9 and 12 months and, if necessary, at least every 6 months thereafter, are suggested. Calculate the difference in length of the specimens, when removed from the moulds at one day and at any subsequent period, to the nearest 0.001 percent of the effective gauge length and record as the expansion of the specimen at that period. A contraction (negative expansion) shall be indicated by prefixing a minus sign to the percentage expansion reported. Report the average of the expansions of the four specimens of a given cement-aggregate combination to the nearest 0.01 percent as the expansion for the combination for a given period.

2.8 Examination at End of Test — After the final length change measurements have been made, each specimen shall be tested for warping and shall be examined.

2.8.1 Warping — The warping, if any, that each specimen has manifested during the test period, shall be determined by placing the specimen on a plane surface and measuring the maximum separation between the specimen and the surface. The specimen shall be placed so that its ends curve down to the reference surface and measurement made to the nearest 0.2 mm.

2.8.2 Examination — Items to be noted in the examination shall include:

- a) Presence, location, and type of pattern of cracking;
- b) Appearance of surfaces, surface mottling; and
- c) Superficial deposits or exudations, their nature, thickness and continuity.

When it is believed that additional features of noteworthy importance are likely to be revealed thereby, a further examination of the interior of the specimen may be made, preferably by a petrographer. In such cases, the presence of gel-filled pores and fissures, evidence of reaction with aggregate particles of specific types and the nature of such evidence, and the properties of the reaction products are among the items to be noted.

2.9 Reporting of Results — The report shall include the following:

- a) Type and source of aggregate;

- b) Type and source of Portland cement;
- c) Alkali content of cement as percent potassium oxide (K_2O), sodium oxide (Na_2O), and calculated sodium oxide (Na_2O) equivalent;
- d) Average length change in percent at each reading of the specimens;
- e) Any relevant information concerning the preparation of aggregates, including the grading of the aggregate when it differs from that given in 2.4.2;
- f) Any significant features revealed by examination of the specimens during and after test;
- g) Amount of mixing water expressed as percentage by weight of cement; and
- h) Type, source, proportions, and chemical analysis, including sodium oxide (Na_2O) and potassium oxide (K_2O), of any pozzolana employed in the tests.

2.10 Repeatability — Repeatability shall be considered satisfactory if the expansion of any specimen does not differ by more than 0.003 percent from the average value of the expansion of all test specimens moulded from the same batch of mortar with the exception that when the average expansion exceeds 0.020 percent, repeatability shall be considered satisfactory if the expansion of any test specimen moulded from the batch of mortar does not differ from the average by more than 15 percent of the average.

3. DETERMINATION OF POTENTIAL REACTIVITY OF AGGREGATES (CHEMICAL METHOD)

3.1 Object — This method of test covers a chemical method for determining the potential reactivity of an aggregate with alkalis in Portland cement concrete as indicated by the amount of reaction during 24 h at 80°C between 1 N sodium hydroxide solution and aggregate that has been crushed and sieved to pass a 300-micron IS Sieve and be retained on a 150-micron IS Sieve.

3.2 Apparatus — The apparatus shall consist of the following:

- a) *Scales* — The scales used in weighing materials for mortar mixes shall conform to the following requirements:

On scales in use, the permissible variation at a load of 2 000 g shall be ± 2.0 g. The permissible variation on new scales shall be one half of this value. The sensibility reciprocal shall be not greater than twice the permissible variation.

- b) *Weights* — The permissible variations on weights in use shall be as prescribed in Table I. The permissible variations on new weights shall be one half of the values in Table I.

c) *Balances* — The analytical balance and weights used for determining dissolved silica by the gravimetric method shall conform to the following requirements:

- 1) Capacity shall be not less than 100 g in each pan,
- 2) The two arms of the beam shall be equal within two parts in 100 000 for balances in use or one part in 100 000 for new balances (*see Note 1*),
- 3) These shall be capable of reproducing results within 0.000 2 g, and
- 4) Sensibility reciprocal* shall be not more than 0.000 5 g per division of the graduated scale for any load up to 100 g (*see Note 2*). In case of direct-reading balances this requirement does not apply.

Any rapid weighing device that may be provided, such as a chain, damped motion, or heavy riders, shall not introduce errors greater than 0.000 1 g at any reading and with any allowable load on the scale pans.

NOTE 1 — The lengths and ratios of the arms may change with use, and with age even if not used.

NOTE 2 — If an auxiliary metal or glass pan is used, its weight is a part of the load.

d) *Crushing and Grinding Equipment* — A small jaw crusher and disc pulverizer or other suitable equipment capable of crushing and grinding approximately 4 kg of aggregate to pass a 300-micron IS Sieve.

e) *Sieves* — 300-micron and 150-micron square-hole, woven wire cloth sieves conforming to IS : 460-1962 Specification for Test Sieves (*Revised*).

f) *Reaction Containers* — Reaction containers (*see Fig. 5*), of 50 to 75 ml capacity, made of stainless steel or other corrosion-resistant material, and fitted with air-tight covers.

g) *Constant-Temperature Bath* — A liquid bath capable of maintaining a temperature of $80 \pm 1^\circ\text{C}$ for 24 h .

h) *Photometer* — A photoelectric photometer capable of measuring the transmission of light at a constant wave length of approximately 410 μ .

3.3 Reagents

3.3.1 Purity of Reagents — Unless otherwise indicated, it is intended that all reagents shall conform to the relevant Indian Standard specifications where such specifications are available. Other grades may be used, provided it is first ascertained that the reagent is of sufficiently high purity to permit its use without lessening the accuracy of the determination.

*The sensibility reciprocal is the amount of weight required to move the position of equilibrium of the pointer one division of the scale.

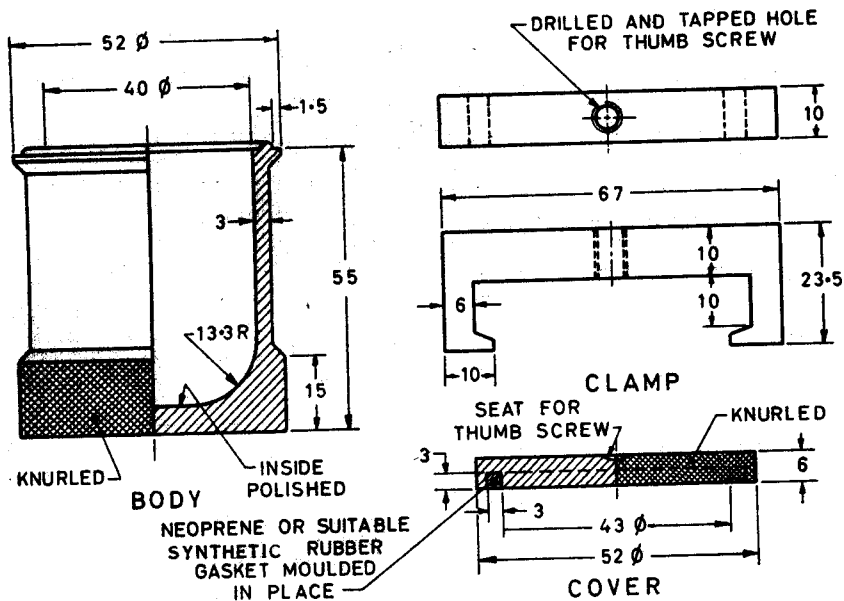

FIG. 5 REACTION CONTAINER

3.3.2 Purity of Water — Unless otherwise indicated, references to water shall be understood to mean distilled water or other water of equal purity.

3.3.3 Ammonium Molybdate Solution — Dissolve 10 g of ammonium molybdate $[(\text{NH}_4)_6\text{Mo}_7\text{O}_{24}\cdot 4\text{H}_2\text{O}]$ in 100 ml of water. If the solution is not clear, filter through a fine-texture paper. Store the solution in a chemically-resistant glass bottle, coated on its interior with paraffin, or in a plastic bottle.

3.3.4 Concentrated Hydrochloric Acid — sp gr 1.19.

3.3.5 Standard Hydrochloric Acid — 0.05 N. Prepare approximately 0.05 N hydrochloric acid and standardize to ± 0.0001 N. Standardize the acid for each day's tests, against an approximately 0.05 N standardized caustic soda solution.

3.3.6 Hydrochloric Acid — 1:1. Mix equal volumes of concentrated hydrochloric acid (sp gr 1.19) and water.

3.3.7 Hydrofluoric Acid (HF)

3.3.8 Oxalic Acid Solution — Dissolve 10 g of oxalic acid dihydrate in 100 ml of water. Store in chemically-resistant glass.

3.3.9 Phenolphthalein Indicator Solution — Dissolve one gram of phenolphthalein in 100 ml of ethanol (1:1).

3.3.10 Standard Silica Solution — Prepare a standard silica solution containing approximately 10 millimoles of silica (SiO_2) per litre by dissolving sodium silicate in water. Store the solution in a hard rubber bottle or a paraffin-coated, chemically-resistant glass bottle. Use a 100-ml aliquot of the solution to determine its silica content by the procedure described in 3.7.1 to 3.7.5. Do not use a standard silica solution older than one year, since dissolved ionic silica in such a solution slowly polymerizes, causing spuriously low photometric readings.

3.3.11 Standard Sodium Hydroxide Solution — 1.000 ± 0.010 N. Prepare a 1.000 ± 0.010 N sodium hydroxide (NaOH) solution and standardize to ± 0.001 N. Standardize the solution against acid potassium phthalate. Use water that has been boiled until free of carbon dioxide to prepare the solution. Store the solution in a polyethylene container and protect from contamination by carbon dioxide.

3.3.12 Concentrated Sulphuric Acid — sp gr 1.84.

NOTE — The silica contents of the reagents, other than the standard silica solution, will not be significant and need not be determined.

3.4 Glassware — All glass apparatus and vessels should be carefully selected to meet the particular requirements for each operation. Standard volumetric flasks, burettes, and pipettes should be of precision grade.

3.5 Selection and Preparation of Test Samples

3.5.1 The test may be used for either fine or coarse aggregate, and when the fine and coarse aggregates are of the same material, it can be used for the total aggregate.

3.5.2 The test sample shall be prepared from a representative portion of the aggregate by crushing so as to pass a 300-micron IS Sieve according to the following procedure. Reduce the coarse aggregate to a maximum size of about 6.3 mm by means of a small jaw crusher. Sieve the crushed coarse aggregate and likewise the sand to recover the 300-micron to 150-micron particles. Discard the material passing the 150-micron IS Sieve. Reduce the material retained on the 300-micron IS Sieve by repeated passes through a disc-type pulverizer, with sieving after each pass. The separation of the plates shall be about 3.15 mm for the first pass and shall be progressively diminished until all the material passes the 300-micron IS Sieve. Every effort shall be made to reduce as much as possible the proportion of fine passing the 150-micron IS Sieve.

NOTE — It is recommended that each size fraction of coarse aggregate be separately processed according to 3.5.2, and that the 300-micron to 150-micron material obtained from each size fraction be combined in the proportions in which those fractions are to be used in the concrete. It is recommended that, wherever possible, the sand be screened and the several size fractions recombined in the proportions to be used in the concrete, prior to processing according to 3.5.2.

3.5.3 To ensure that all material finer than the 150-micron IS Sieve has been removed, wash the sample over a 150-micron IS Sieve. Do not wash more than 100 g over a 200-mm Sieve at one time. Dry the washed sample at 100 to 105°C for 20 ± 4 h. Cool the sample and again sieve on the 150-micron IS Sieve. If inspection of the sample indicates the presence of silty or clayey coatings on particles, repeat the washing and drying procedure, and sieve as before over the 150-micron IS Sieve. Reserve the portion retained on the 150-micron IS Sieve for the test sample.

3.6 Reaction Procedure

3.6.1 Weigh three representative 25.00 ± 0.05 g portions of the dry 300-micron to 150-micron test sample prepared in accordance with 3.5. Place one portion in each of three of the reaction containers and add by means of a pipette or burette 25 ml of the 1.000 N caustic soda solution. To a fourth reaction container, by means of a pipette or burette, add 25 ml of the same caustic soda solution to serve as a blank. Seal the four containers and gently swirl them to liberate trapped air.

3.6.2 Immediately after the containers have been sealed, place them in a liquid bath maintained at $80 \pm 1.0^\circ\text{C}$. After $24 \pm \frac{1}{4}$ h remove the containers from the bath and cool them under flowing water for 15 ± 2 minutes to below 30°C .

3.6.3 After the containers have been cooled, open them and filter the solution from the aggregate residue. Use a porcelain Gooch crucible with a disc of rapid, low-ash filter paper cut to fit the bottom of the crucible, setting the crucible in a rubber crucible holder in a funnel. Place a dry test-tube, of 35 to 50 ml capacity, in the filter flask to collect the filtrate, and seat the funnel in the neck of the filter flask. With the aspirator in operation or the vacuum line open, decant a small quantity of the solution onto the filter paper so it will seat properly in the crucible. Without stirring the contents of the container, decant the remaining free liquid into the crucible. When the decantation of the liquid has been completed, discontinue the vacuum and transfer the solids remaining in the container to the crucible and pack in place with the aid of a stainless steel spatula. Then apply and adjust the vacuum to approximately 375 mm of mercury. Continue the filtration until further filtration yields filtrate at the approximate rate of one drop every 10 seconds; reserve the filtrate for further tests. Record the total amount of time during which the vacuum is applied as the filtration time; every effort shall be made to achieve an equal filtration time for all samples in a set, by uniformity of procedure in the assembly of the filtration apparatus and the packing of the solids in the crucible.

3.6.4 Filter the blank according to the procedure described in 3.6.3. Apply the vacuum for a length of time equal to the average filtration time for the three specimens.

3.6.5 Immediately following the completion of filtration, stir the filtrate to assume homogeneity, then take an aliquot of 10 ml of the filtrate and

dilute with water to 200 ml in a volumetric flask. Reserve this diluted solution for the determination of dissolved silica and reduction in alkalinity.

NOTE — If the diluted filtrate is not to be analyzed within 4 hr following completion of the filtration, transfer the solution to a clean, dry polyethylene container and close the container by means of a stopper or tight-fitting cap or lid.

3.7 Determination of Dissolved Silica by the Gravimetric Method

3.7.1 Transfer 100 ml of the dilute solution (*see* 3.6.5) to an evaporating dish, preferably of platinum for the sake of celerity in evaporation, add 5 to 10 ml of hydrochloric acid (sp gr 1.19), and evaporate to dryness on a steam-bath. Without heating the residue any further, treat it with 5 to 10 ml of hydrochloric acid (sp gr 1.19), and evaporate to dryness on a steam-bath. Without heating the residue any further, treat it with 5 to 10 ml of hydrochloric acid (sp gr 1.19), and then an equal amount of water, or at once pour 10 to 20 ml of hydrochloric acid (1:1) upon the residue. Cover the dish and digest for 10 minutes on the bath or a hot-plate. Dilute the solution with an equal volume of hot water, filter immediately, and wash the separated silica (SiO_2) thoroughly with hot water (*see* Note) and reserve the residue.

NOTE — The washing of the silica precipitates can be made more effective by using hot dilute hydrochloric acid (1: 99) and then completing the washing with hot water.

3.7.2 Again evaporate the filtrate to dryness, baking the residue in an oven for one hour at 105 to 110°C. Take up the residue with 10 to 15 ml of hydrochloric acid (1:1) and heat on the bath or the hot-plate. Dilute the solution with an equal volume of hot water and catch, and wash the small amount of silica it contains on another filter paper.

3.7.3 Transfer the filter papers containing the residue (*see* 3.7.1 and 3.7.2) to a platinum crucible. Dry and ignite the papers, first at a low heat until the carbon of the filter paper is completely consumed without inflaming, and finally at 1100 to 1200°C until the weight becomes constant.

NOTE — The empty crucible may be weighed if one wishes to know for one's own information the magnitude of impurities in the residue of silica.

3.7.4 Treat silica thus obtained, which will contain small amounts of impurities, in the crucible with a few drops of water, about 10 ml of hydrofluoric acid, and one drop of sulphuric acid, and evaporate cautiously to dryness. Finally, heat the residue at 1050 to 1100°C for 1 to 2 minutes, cool, and weigh. The difference between this weight and the weight previously obtained represents the amount of silica.

3.7.5 Blank — Make a blank determination, following the same procedure, using the same amount of diluted solution from the blank and the same amount of reagents.

3.7.6 Calculation — Calculate the silica concentration of the caustic soda solution filtered from the aggregate material as follows:

$$S_c = (W_1 - W_2) \times 3\,330$$

where

S_c = concentration of silica in millimoles per litre in the original filtrate,

W_1 = weight of silica in g found in 100 ml of the dilute solution (see 3.7.4), and

W_2 = weight of silica in g found in the blank (see 3.7.5).

NOTE — The dilute solution analyzed is equivalent to 5 ml of the original filtrate and contains $(W_1 - W_2)$ grams or $\frac{(W_1 - W_2)}{60.06} \times 1\,000$ millimoles of silica; consequently, one litre of the original filtrate would contain $\frac{1\,000}{5} \times \frac{1\,000}{60.06} (W_1 - W_2)$ or 3 330 $(W_1 - W_2)$ millimoles of silica.

3.8 Determination of Dissolved Silica by the Photometric Method

3.8.1 Application — This method is applicable to the determination of crystalloidal (noncolloidal) silica in all aqueous solutions except those with excessive colour interferences (such as tannin), but it will not determine total silica. The method is particularly applicable to rapid control analysis of crystalloidal silica below 10 parts per million.

3.8.2 Summary of Method — Crystalloidal (noncolloidal) silica reacts with molybdate ion in acid solution (optimum pH 1.2 to 1.5) to form a greenish-yellow silica-molybdate colour complex. This is approximately proportional to the silica concentration of the solution, but does not follow Beer's law perfectly. The colour complexes are quantitatively evaluated by comparison with standard colours, using a photoelectric photometer.

3.8.3 Preparation of Calibration Curve

3.8.3.1 Prepare a series of solutions of known silica concentration varying from 0.0 to 0.5 millimoles per litre by diluting portions of the stock solution of sodium silicate (see 3.3.10). Transfer the portions of sodium silicate solution to 100-ml volumetric flasks about half filled with water. Add 2 ml of the ammonium molybdate solution and 1 ml of hydrochloric acid (1:1), and agitate by swirling the flask. Allow the solution to stand for 15 minutes at room temperature. Add 1.5 ± 0.2 ml of the oxalic acid solution, fill the flask to the mark with water, and mix thoroughly. Allow the solution to stand for 5.0 ± 0.1 minutes.

3.8.3.2 Read the transmittance of the various solutions on the photometer at approximately $410\text{ m}\mu$, in comparison with a reference solution containing all of the reagents, but no silica, in 100 ml of water.

3.8.3.3 Prepare a calibration curve by plotting the percent transmittance readings against the known concentrations of silica in each solution.

3.8.4 Determination of Dissolved Silica — Transfer a 10-ml aliquot of the dilute solution (see 3.6.5) to a 100-ml volumetric flask and proceed as described in 3.8.3.1. Read the concentration of silica in the solution directly from the previously prepared calibration curve correlating transmission of light of this wavelength with silica concentration. If the transmittance is below 30 percent or above 50 percent, a smaller or larger aliquot of the diluted solution should be used.

3.8.5 Calculation — Calculate the silica concentration of the caustic soda solution filtered from the aggregate material as follows:

$$S_e = 20 \times \frac{100}{V} \times C$$

where

S_e = concentration of silica in millimoles per litre in the original filtrate,

C = concentration of silica millimoles per litre in the solution measured in the photometer, and

V = volume of dilute solution in millilitres used from 3.6.5.

3.9 Reduction in Alkalinity

3.9.1 Procedure — Transfer a 20-ml aliquot of the dilute solution (see 3.6.5) to a 125-ml Erlenmeyer flask, add 2 or 3 drops of phenolphthalein solution, and titrate with 0.05 N hydrochloric acid to the phenolphthalein end point.

3.9.2 Calculation — Calculate the reduction in alkalinity as follows:

$$R_e = \frac{20 N}{V_1} (V_3 - V_2) \times 1\ 000$$

where

R_e = the reduction in alkalinity, in millimoles per litre;

N = normality of the hydrochloric acid used for the titration;

V_1 = volume in ml of dilute solution used from 3.6.5;

V_2 = volume of hydrochloric acid in ml used to attain the phenolphthalein end point in the test sample; and

V_3 = volume of hydrochloric acid in ml used to attain the phenolphthalein end point in the blank.

NOTE — The procedure and calculation described in 3.9.1 and 3.9.2 shall be followed in obtaining values for R_e to be used together with S_e values to evaluate the potential reactivity of aggregates.

Additional information may be obtained if a further titration is made to the methyl orange end point and additional calculations are made. After the phenolphthalein end point has been reached, add 2 or 3 drops of methyl orange solution (0.1 g of methyl orange in 100 ml of water) and titrate to the methyl orange end point. Let P be the volume of hydrochloric acid used to obtain the phenolphthalein end point and T is the total volume of acid used to obtain the methyl orange end point. Calculate a value of R_c based on the two end points, using the formula given in 3.9.2 and substituting values of V_2 and V_3 obtained from the equation:

$$V_2, V_3 = 2P - T$$

3.10 Interpretation of Results

3.10.1 Data correlating the results of this method with performance of aggregates in structures, expansion of mortar bars containing high-alkali cement, or petrographic examination should be reviewed before results of the method are used as a basis for conclusions and recommendations concerning the properties and use of aggregates for concrete. For most aggregates, a potentially deleterious degree of alkali reactivity is indicated if the plotted data point falls to the right of the boundary line shown in Fig. 6.

3.10.2 Results of the test are not correct for some aggregates, primarily because of extraneous reduction of alkalinity (spurious increase of R_c or decrease in S_c , or both) produced by reaction of the sodium hydroxide with carbonates of magnesium or ferrous iron or certain silicates of magnesium, such as antigorite (serpentine). In the presence of soluble silica, calcium carbonate may also cause small anomalous increases in R_c and may either increase or decrease the values of S_c . The spurious changes of R_c and S_c caused by calcium carbonate affect the apparent degree of reactivity but an erroneous indication of potential reactivity is produced only if the degree of alkali reactivity of the aggregate is marginal.

3.10.3 Data show that aggregates represented by data points falling to the right of the boundary line shown in Fig. 6 and above a line extending from about point $R_c=75$, $S_c=70$ to a point $R_c=125$, $S_c=1\ 000$ may be sufficiently alkali-reactive to produce comparatively low expansion when tested in accordance with 2. In this circumstance, the results of the chemical test should be accepted as indicating a potentially deleterious degree of alkali reactivity unless the innocuous character of the aggregate is demonstrated by supplementary tests in accordance with 2 of several mixtures of the test aggregate and an essentially inert aggregate, such as properly graded quartz, Ennore sand, or chert-free limestone. The mixtures should represent a series of proportions of the test aggregate and essentially inert aggregate ranging from about 5:95 to 50:50 by weight.

3.10.4 In order to evaluate these possible effects, it is recommended that performance of the method be correlated with petrographic examination in accordance with Part VIII of this standard or any other test method or field experience that is applicable.

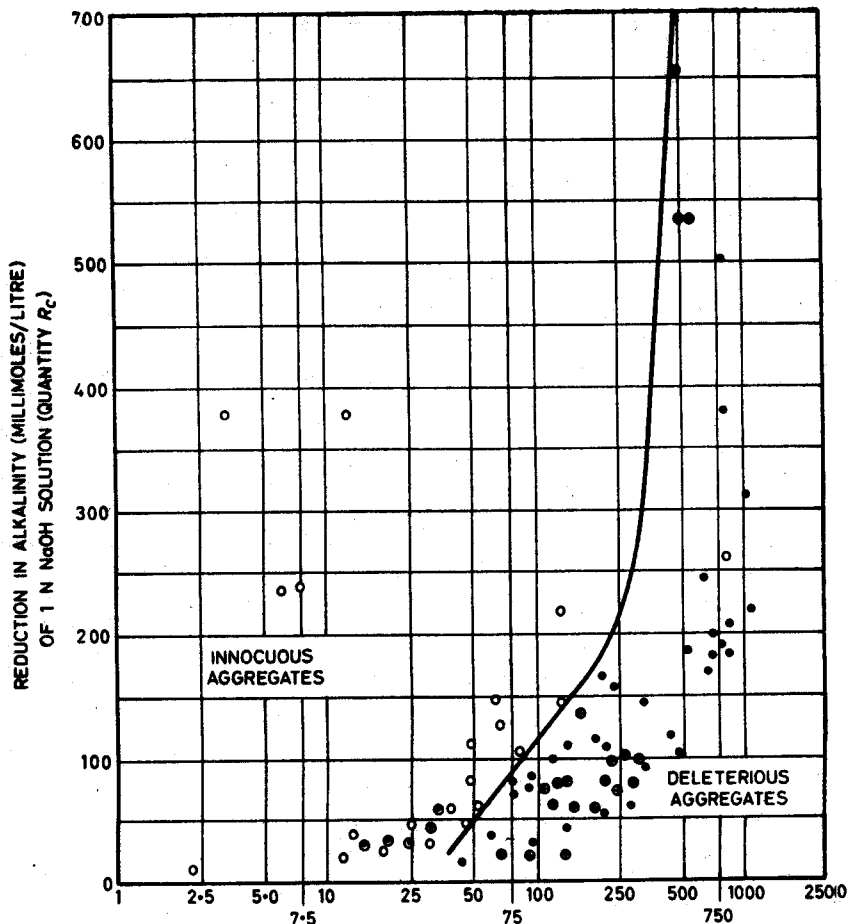

SILICA DISSOLVED FROM 300 TO 150 MICRONS SIZE AGGREGATE MATERIAL (MILLIMOLES/LITRE) BY 1 N NaOH SOLUTION (QUANTITY S_c)

- Aggregates causing mortar expansion more than 0.1 percent in a year when used with a cement containing 1.38 percent alkalis.
- Aggregates causing mortar expansion less than 0.1 percent in a year under same conditions.
- ⊗ Aggregates for which mortar expansions data are not available but which are indicated to be deleterious by petrographic examination.
- ⊙ Aggregates for which mortar expansion data are not available but which are indicated to be innocuous by petrographic examination.
- Boundary line between innocuous and deleterious aggregates.

FIG. 6 ILLUSTRATION OF DIVISION BETWEEN INNOCUOUS AND DELETERIOUS AGGREGATES ON BASIS OF REDUCTION IN ALKALINITY TEST

AMENDMENT NO. 1 JUNE 1999
TO
IS 2386 (PART VII) 1963 METHODS OF TEST
FOR AGGREGATES FOR CONCRETE
PART VII ALKALI AGGREGATE REACTIVITY

(Page 15, clause 2.10) — Insert the following new clauses after 2.10:

‘2.11 For aggregates, though not containing known deleterious silica minerals like opal, chalcedony, tridymite and cristobolite, xerolite, heulandite, glassy to crypto-crystalline rhyolites, decites and andesites and their tuffs and certain phyllites but containing more than 20 percent strained quartz undulatory extinction angle greater than 15° causing deleterious reaction [see IS 2386 (Part VIII) : 1963] and also possibly showing presence of microcrystalline quartz, additional mortar-bar test with conditions as given in 2.11.1 and 2.11.2 keeping other condition same, shall be conducted.

2.11.1 The specimens shall be placed in the metal container only and the storage temperature in the container shall be $60 \pm 2^{\circ}\text{C}$.

2.11.2 Ordinary Portland cement whose alkali content is 1.0 percent or more (expressed as $\text{Na}_2\text{O} + 0.658 \text{K}_2\text{O}$) shall be used for evaluation instead of 0.6 percent specified in Note 1 under 2.4.3, other cement aggregate combination specified under 2.4.3 remaining the same.

2.12 It is recommended that strained quartz bearing aggregates showing 180 day expansions of 0.06 percent using ordinary Portland cement with 1.0 percent or more alkali content as per 2.11.2 be classified as potentially reactive.

NOTES

1 For coarse aggregate of composite nature, the test shall be conducted on the composite sample.

2 The test is of accelerated nature and suitable for strained quartz bearing aggregates only which are slow-reactive in nature. The test is not suitable for aggregates containing conventional known deleterious silica minerals mentioned above.

(CED 2)